

SYLLABUS - 2016

INTERMEDIATE : PAPER -

9

OPERATIONS MANAGEMENT & STRATEGIC MANAGEMENT

INTERMEDIATE

STUDY NOTES



The Institute of Cost Accountants of India

CMA Bhawan, 12, Sudder Street, Kolkata - 700 016

First Edition : August 2016
Reprint : April 2017
Reprint : June 2018
Revised Edition : October 2018
Revised Edition : January 2019
Edition : August 2019
Reprint : March 2020
Reprint : August 2020
Reprint : October 2020
Reprint : January 2021
Reprint : March 2021
Reprint : September 2021
Reprint : January 2022

Published by :

Directorate of Studies
The Institute of Cost Accountants of India
CMA Bhawan, 12, Sudder Street, Kolkata - 700 016
www.icmai.in

Printed at :

M/s. SAP Print Solutions Pvt. Ltd.
28A, Lakshmi Industrial Estate
S. N. Path, Lower Parel (W)
Mumbai - 400 013, Maharashtra

Copyright of these Study Notes is reserved by the Institute of Cost Accountants of India and prior permission from the Institute is necessary for reproduction of the whole or any part thereof.

Syllabus - 2016

PAPER 9: OPERATIONS MANAGEMENT & STRATEGIC MANAGEMENT (OMSM)

Syllabus Structure

The syllabus comprises the following topics and study weightage:

A	Operations Management	70%
B	Strategic Management	30%

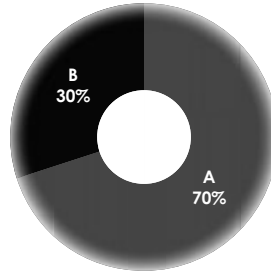

ASSESSMENT STRATEGY

There will be examination of three hours.

OBJECTIVE

To provide an in depth study of the various business process, analyze operations, production planning and strategic management.

Learning Aims

The syllabus aims to test the student's ability to:

- Understand the business process and analyze the operations
- Acquire knowledge of production planning and resource management
- Understand the concept of Corporate Vision - Mission and Objectives
- Understand the concept of SWOT and Portfolio Analysis
- Understand the different stages in strategy formulation process
- Understand the concept of Strategic Business Unit and Business Process re-engineering

Skill Set required

Level B: Requiring the skill levels of knowledge, comprehension, application and analysis.

Section A : Operations Management		70%
1.	Operations Management – Introduction	
2.	Operations Planning	
3.	Designing of Operational Systems and control	
4.	Production Planning and control	
5.	Productivity management and quality management	
6.	Project Management	
7.	Economics of Maintenance and Spares management	
Section B : Strategic Management		30%
8.	Strategic Management Introduction	
9.	Strategic Analysis and Strategic Planning	
10.	Formulation and Implementation of Strategy	

SECTION A: OPERATIONS MANAGEMENT [70 MARKS]

1. Operation Management Introduction:

Scope characteristics of modern operations functions - recent trends in production / operations management.

2. Operations Planning:

Demand forecasting – capacity planning - capacity requirement planning - facility location - facility layout – Resource aggregate planning – Material requirements planning – Manufacturing resource planning – Economic Batch quantity.

3. Designing of operational systems and control:

Product Design, Process design - Selection - Product Life Cycle – Process Planning – Process Selection.

4. Production planning and Control:

Introduction – Control Measures – Time study, Work study, Method study, Job Evaluation, Job Allocation (Assignment Technique), Scheduling Queuing Models, Simulation and Line Balancing – Optimum Allocation of resources – Lean Operations – JIT – Transportation Model and Linear Programming Technique (Formulation of equations only).

5. Productivity Management and Quality Management:

Measurement techniques of productivity index, productivity of employee, productivity of materials, productivity of management resources, productivity of other factors – productivity improving methods – TQM basic tools and certification – ISO standards basics.

6. Project Management:

Project planning – project life cycle – Gantt charts, PERT and CPM.

7. Economics of Maintenance and Spares Management:

Break down Maintenance – Preventive Maintenance – Routine Maintenance – Replacement of Machine – Spare Parts Management.

Section B: Strategic Management [30 marks]

8. Strategic Management Introduction

Vision- Mission and objective

9. Strategic Analysis and Strategic Planning

Situational Analysis – SWOT Analysis – Portfolio Analysis – BCG Matrices – Stages in Strategic Planning – Alternatives in Strategic Planning

10. Formulation and Implementation of Strategy:

Strategy formulation function wise (Production Strategy, Marketing Strategy, Man Power Strategy) – Structuring of Organisation for implementation of strategy – Strategic Business Unit – Business Process re-engineering.

Contents

SECTION - A : OPERATIONS MANAGEMENT

Study Note 1 : Operation Management – Introduction

1.1	Operations Management - Introduction	1
1.2	Production Management vs. Operation Management	3
1.3	Characteristic of Modern Operation Function	4
1.4	Recent Trends in Production / Operations Management	4

Study Note 2 : Operations Planning

2.1	Demand Forecasting	7
2.2	Capacity Planning	15
2.3	Capacity Requirement	17
2.4	Facility Location	21
2.5	Facility Layout	24
2.6	Resource Aggregate Planning	33
2.7	Material Requirements Planning	36
2.8	Manufacturing Resource Planning	37
2.9	Enterprise Resource Planning	38
2.10	Economic Batch Quantity	38

Study Note 3 : Designing of Operational System and Control

3.1	Production Design	47
3.2	Process Design & Selection	50
3.3	Process Planning	50
3.4	Product Life Cycle	52
3.5	Process Selection	53

Study Note 4 : Production Planning and Control

4.1	Production Planning and Control Introduction	55
4.2	Time Study, Work Study, Method Study & Job Evaluation	58
4.3	Job Allocation – Assignment Technique	61
4.4	Scheduling	77
4.5	Queuing Models	82

4.6	Simulation	94
4.7	Line Balancing	105
4.8	Lean Operations	110
4.9	Just-In-Time (JIT)	111
4.10	Transportation Model	111
4.11	Linear Programming Technique	129

Study Note 5 : Productivity Management and Quality Management

5.1	Measurement Techniques of Productivity Index	153
5.2	TQM Basic Tools and Certification	161
5.3	ISO Standard Basics	163

Study Note 6 : Project Management

6.1	Project Planning	169
6.2	Gantt Charts	174
6.3	PERT and CPM	180

Study Note 7 : Economics of Maintenance and Spares Management

7.1	Break Down Maintenance	195
7.2	Preventive Maintenance	195
7.3	Routine Maintenance	196
7.4	Replacement of Machine	198
7.5	Spare Parts Management	201

SECTION - B : STRATEGIC MANAGEMENT

Study Note 8 : Strategic Management Introduction

8.1	Vission, Mission and Objective	227
-----	--------------------------------	-----

Study Note 9 : Strategic Analysis and Strategic Planning

9.1	Situational Analysis	243
9.2	SWOT Analysis	245
9.3	Portfolio Analysis	247
9.4	BCG Matrices	249
9.5	Stages in Strategic Planning	255
9.6	Alternative in Strategic Planning	258
9.7	Pestel Framework	260
9.8	Porter's Five Forces Framework	261
9.9	Structural Drivers of Change	264
9.10	Diversification Strategy	264

Study Note 10 : Formulation and Implementation of Strategy

10.1	Strategy Formulation Function-wise (Production Strategy, Marketing Strategy, Manpower Strategy)	267
10.2	Structuring of Organisation for Implementation of Strategy	281
10.3	Strategic Business Unit	285
10.4	Business Process Re-engineering	286
10.5	Core Competence and Critical Success Factors	290



Section : A
Operations Management
(Syllabus - 2016)





Study Note - 1

OPERATIONS MANAGEMENT – INTRODUCTION



This Study Note includes

- 1.1 Operations Management - Introduction
- 1.2 Production Management vs. Operation Management
- 1.3 Characteristic of Modern Operation Function
- 1.4 Recent Trends in Production/Operations Management

1.1 OPERATIONS MANAGEMENT - INTRODUCTION

Operations management is the management of that part of an organization that is responsible for producing goods and/or services. There are examples of these goods and services all around you. Every book you read, every video you watch, every e-mail you send, every telephone conversation you have, and every medical treatment you receive involves the operations function of one or more organizations. So does everything you wear, eat, travel in, sit on, and access the Internet with.

However, in order to have a clear idea of Operations Management, one must have an idea of 'Operating Systems'.

An **Operating System** is defined as a configuration of resources combined for the provision of goods or services.

Retail organizations, hospitals, bus and taxi services, tailors, hotels and dentists are all examples of operating systems. Any operating system converts inputs, using physical resources, to create outputs, the function of which is to satisfy customers wants. The creation of goods or services involves transforming or converting inputs into outputs. Various inputs such as capital, labour, and information are used to create goods or services using one or more transformation processes (e.g., storing, transporting, and cutting). To ensure that the desired output are obtained, an organization takes measurements at various points in the transformation process (feedback) and then compares with them with previously established standards to determine whether corrective action is needed (control).

It is important to note that goods and services often occur jointly. For example, having the oil changed in your car is a service, but the oil that is delivered is a good. Similarly, house painting is a service, but the paint is a good. The goods-service combination is a continuum. It can range from primarily goods, with little service, to primarily service, with few goods. Because there are relatively few pure goods or pure services, companies usually sell product packages, which are a combination of goods and services. There are elements of both goods production and service delivery in these product packages. This makes managing operations more interesting, and also more challenging.

OBJECTIVES OF OPERATIONS MANAGEMENT

Objectives of operations management can be categorised into (i) Customer service and (ii) Resource utilisation.

(i) Customer service

The first objective is the customer service which means the service for the satisfaction of customer wants. Customer service is therefore a key objective of operations management.

The Operations Management must provide something to a specification which can satisfy the customer in terms of cost and timing. Thus, primary objective can be satisfied by providing the 'right thing at the right price at the right time'.

These three aspects of customer service - specification, cost and timing - are described in a little more detail for the four functions in **Table 1**. They are the principal sources of customer satisfaction and must, therefore, be the principal dimension of the customer service objective for operation managers.

Table 1: Aspects of Customer Service

Principal customer wants		
Principal function	Primary consideration	Other consideration
Manufacture	Goods of a given, requested or acceptable specification	Cost i.e. purchase price or cost of obtaining goods Timing, i.e. delivery delay from order or request to receipt of goods
Transport	Movement of a given, requested or acceptable specification	Cost, i.e. cost of movement, Timing, i.e. (i) duration or time to move (ii) wait, or delay from requesting to its commencement
Supply	Goods of a given, requested or acceptable specification	Cost, that is purchase price or cost obtaining goods Timing, i.e. delivery delay from order or request to supply, to receipt of goods
Service	Treatment of a given, requested or acceptable specification	Cost, i.e. cost of treatment Timing, i.e. (i) Duration or timing required for treatment (ii) wait, or delay from requesting to its commencement

Generally an organization will aim reliably and consistently to achieve certain standards, or levels, on these dimensions, and operations managers will be influential in attempting to achieve these standards.

Hence, this objective will influence the operations manager's decisions to achieve the required customer service.

(ii) Resource Utilization

Another major objective is to utilize resources for the satisfaction of customer wants effectively, i.e., customer service must be provided with the achievement of effective operations through efficient use of resources. Inefficient use of resources or inadequate customer service leads to commercial failure of an operating system.

Operations management is concerned essentially with the utilization of resources, i.e., obtaining maximum effect from resources or minimizing their loss, under utilization or waste. The extent of the utilization of the resources' potential might be expressed in terms of the proportion of available time used or occupied, space utilization, levels of activity, etc. Each measure indicates the extent to which the potential or capacity of such resources is utilized. This is referred as the objective of resource utilization.

Operations management is also concerned with the achievement of both satisfactory customer service and resource utilization. An improvement in one will often give rise to deterioration in the other. Often both cannot be maximized, and hence a satisfactory performance must be achieved on both objectives. All the activities of operations management must be tackled with these two objectives in mind, and many of the problems will be faced by operations managers because of this conflict. Hence, operations managers must attempt to balance these basic objectives.

Below **Table 2** summarizes the twin objectives of operations management. The type of balance established both between and within these basic objectives will be influenced by market considerations, competitions, the strengths and weaknesses of the organization, etc. Hence, the operations managers should make a contribution when these objectives are set.

Table 2 : The twin objectives of operations management

The customer service objective.	The resource utilization objective.
To provide agreed/adequate levels of customer service (and hence customer satisfaction) by providing goods or services with the right specification, at the right cost and at the right time.	To achieve adequate levels of resource utilization (or productivity) e.g., to achieve agreed levels of utilization of materials, machines and labour.

SCOPE OF OPERATION MANAGEMENT

Operations Management concerns with the conversion of inputs into outputs, using physical resources, so as to provide the desired utilities to the customer while meeting the other organizational objectives of effectiveness, efficiency and adoptability. It distinguishes itself from other functions such as personnel, marketing, finance, etc. by its primary concern for 'conversion by using physical resources'. Following are the activities, which are listed under Production and Operations Management functions:

1. Location of facilities.
2. Plant layouts and Material Handling.
3. Product Design.
4. Process Design.
5. Production Planning and Control.
6. Quality Control.
7. Materials Management.
8. Maintenance Management.

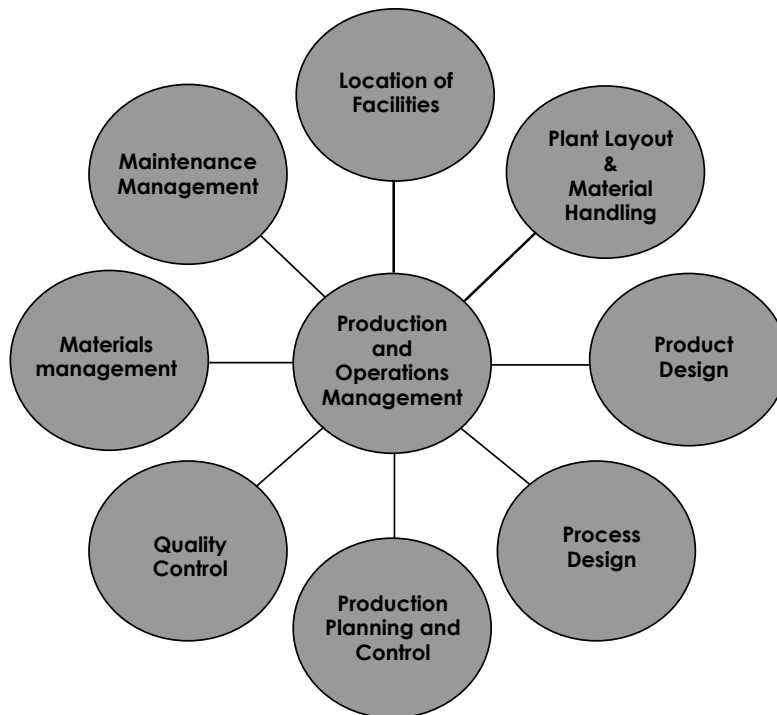

Fig. 1 : Scope of production and operations management

1.2 PRODUCTIONS MANAGEMENT vs OPERATIONS MANAGEMET

There are two points of distinction between production management and operations management. First, the term production management is more used for a system where tangible goods are produced. Whereas, operations management is more frequently used where various inputs are transformed into intangible services. Viewed from this perspective, operations management will cover such service organisations as banks, airlines, utilities, pollution control agencies, super bazaars, educational institutions, libraries, consultancy firms and police departments, in addition, of course, to manufacturing enterprises. The second distinction relates to the evolution of the subject. Operations management is the term that is used nowadays. Production management precedes operations management in the historical growth of the subject.



1.3 CHARACTERISTIC OF MODERN OPERATIONS FUNCTION

The production management of today presents certain characteristics which make it look totally different from what it was during the past. Specifically, today's production system is characterised by at least four features.

1. Manufacturing as Competitive Advantage

In the past production was considered to be like any other function in the organisation. When demand was high and production capacities were inadequate, the concern was to somehow muster all inputs and use them to produce goods which would be grabbed by market. But today's scenario is contrasting. Plants have excess capacities, competition is mounting and firms look and gain competitive advantage to survive and succeed. Interestingly, production system offers vast scope to gain competitive edge and firms intend to exploit the potential. Total Quality Management (TQM), Time-Based Competition, Business Process Re-engineering (BPRE), Just-in-Time (JIT), Focused Factory, Flexible Manufacturing Systems (FMS), Computer Integrated Manufacturing (CIM), and The Virtual Corporation are but only some techniques which the companies are employing to gain competitive advantage.

2. Services Orientation

As was stated earlier, service sector is gaining greater relevance these days. The production system, therefore, needs to be organised keeping in mind the peculiar requirements of the service component. The entire manufacturing needs to be geared to serve (i) intangible and perishable nature of the services, (ii) constant interaction with clients or customers, (iii) small volumes of production to serve local markets, and (iv) need to locate facilities to serve local markets. There is increased presence of professionals on the production, instead of technicians and engineers.

3. Disappearance of Smokestacks

Protective labour legislation, environmental movement and gradual emergence of knowledge based organisations have brought total transformation in the production system. Today's factories are aesthetically designed and built, environment friendly - in fact, they are homes away from homes. Going to factory everyday is no more excruciating experience, it is like holidaying at a scenic spot. A visit to ABB, L & T or Smith Kline and Beecham should convince the reader about the transformation that has taken place in the wealth creation system.

4. Small has Become Beautiful

It was E.F. Schumacher who, in his famous book *Small is Beautiful*, opposed giant organisations and increased specialisation. He advocated, instead, intermediate technology based on smaller working units, community ownership, and regional workplaces utilising local labour and resources. For him, small was beautiful. Businessmen, all over the world, did not believe in Schumacher's philosophy. Inspired by economies of scale, industrialists went in for huge organisations and mass production systems.

1.4 RECENT TRENDS IN PRODUCTION/OPERATIONS MANAGEMENT

Recent trends in production/operations management relate to global competition and the impact it has on manufacturing firms. Some of the recent trends are :

1. **Global Market Place** : Globalisation of business has compelled many manufacturing firms to have operations in many countries where they have certain economic advantage. This has resulted in a steep increase in the level of competition among manufacturing firms throughout the world.
2. **Production/Operations Strategy**: More and more firms are recognising the importance of production/operations strategy for the overall success of their business and the necessity for relating it to their overall business strategy.
3. **Total Quality Management (TQM)** : TQM approach has been adopted by many firms to achieve customer satisfaction by a never-ending quest for improving the quality of goods and services.



4. **Flexibility** : The ability to adapt quickly to changes in volume of demand, in the product mix demanded, and in product design or in delivery schedules, has become a major competitive strategy and a competitive advantage to the firms. This is sometimes called as *agile manufacturing*.
5. **Time Reduction** : Reduction of manufacturing cycle time and speed to market for a new product provide competitive edge to a firm over other firms. When companies can provide products at the same price and quality, quicker delivery (short lead times) provide one firm competitive edge over the other.
6. **Technology** : Advances in technology have led to a vast array of new products, new processes and new materials and components. Automation, computerisation, information and communication technologies have revolutionised the way companies operate. Technological changes in products and processes can have great impact on competitiveness and quality, if the advanced technology is carefully integrated into the existing system.
7. **Worker Involvement** : The recent trend is to assign responsibility for decision making and problem solving to the lower levels in the organisation. This is known as employee involvement and empowerment. Examples of worker involvement are quality circles and use of work teams or quality improvement teams.
8. **Re-engineering** : This involves drastic measures or break-through improvements to improve the performance of a firm. It involves the concept of clean-slate approach or starting from scratch in redesigning the business processes.
9. **Environmental Issues** : Today's production managers are concerned more and more with pollution control and waste disposal which are key issues in protection of environment and social responsibility. There is increasing emphasis on reducing waste, recycling waste, using less-toxic chemicals and using biodegradable materials for packaging.
10. **Corporate Downsizing (or Right Sizing)** : Downsizing or right sizing has been forced on firms to shed their obesity. This has become necessary due to competition, lowering productivity, need for improved profit and for higher dividend payment to shareholders.
11. **Supply-Chain Management**: Management of supply-chain, from suppliers to final customers reduces the cost of transportation, warehousing and distribution throughout the supply chain.
12. **Lean Production**: Production systems have become lean production systems which use minimal amounts of resources to produce a high volume of high quality goods with some variety. These systems use flexible manufacturing systems and multi-skilled workforce to have advantages of both mass production and job production (or craft production).





Study Note - 2

OPERATIONS PLANNING



This Study Note includes

- 2.1 Demand Forecasting
- 2.2 Capacity Planning
- 2.3 Capacity Requirement
- 2.4 Facility Location
- 2.5 Facility Layout
- 2.6 Resource Aggregate Planning
- 2.7 Material Requirements Planning
- 2.8 Manufacturing Resource Planning
- 2.9 Enterprise Resource Planning
- 2.10 Economic Batch Quantity

2.1 DEMAND FORECASTING

Forecasting

Forecasting means peeping into the future. As future is unknown and is anybody's guess but the business leaders in the past have evolved certain systematic and scientific methods to know the future by scientific analysis based on facts and possible consequences. Thus, this systematic method of probing the future is called forecasting. In this way forecasting of sales refers to an act of making prediction about future sales followed by a detailed analysis of facts related to future situations and forces which may affect the business as a whole.

Foresight is not the whole of management, but at least it is an essential part of management and accordingly, to foresee in this context means both to assess the future and make provisions for it, that is forecasting is itself in action already. Forecasting is a kind of future picture wherein proximate events are outlined with some distinctness, while remote events appear progressively less distinct and it entails the running of the business as foresee and provide means to run the business over a definite period.

As far as the marketing manager is concerned the sales forecast is an estimate of the amount of unit sales for a specified future period under the proposed marketing plan or program. It may also be defined as an estimate of sales in rupees of physical units for a specified future period under a proposed marketing plan or program and under an assumed set of economic and other force outside the organisation for which the forecast is made.

When we consider the function of production and operations management, no doubt Production and Operation departments will produce goods as per the sales program given by the sales department, but it has to prepare forecast regarding machine capacity required, materials required and time required for production and so on. This needs the knowledge of what exactly happened in the production shop in previous periods.

Making of a proper forecast requires the assessment of both controllable and uncontrollable factors (both economic and non economic) inside and outside the organisation.

All business and industrial activities revolve around the sale and its future planning. To know what a business will do we must know its future sales. So, sales forecasting is the most important activity in the business because all other activities depend upon the sales of the concern. Sales forecasting is a guiding factor for a firm because it enables the firm to concentrate its efforts to produce the required quantities, at the right time at reasonable price and of the right quality. Sales forecasting is the basis of planning the various activities i.e.; production activities, pricing policies, programme policies and strategies, personnel policies as to recruitment, transfer, promotion, training, wages etc.



The period of forecasting, that is the time range selected for forecasting depends on the purpose for which the forecast is made. The period may vary from one week to some years. Depending upon the period, the forecast can be termed as 'Short range forecasting', medium range forecasting' and 'Long range forecasting'. 'Short range forecasting period may be one week, two weeks or a couple of months. Medium range forecasting period may vary from 3 to 6 months. Long range forecasting period may vary from one year to any period. The objective of above said forecast is naturally different.

In general, short term forecasting will be more useful in production planning. The manager who does short range forecast must see that they are very nearer to the accuracy.

In long range forecast, the normal period used is generally 5 years. In some cases it may extends to 10 to 15 years also. The purpose of long range forecast is:

- (i) To work out expected capital expenditure for future developments or to acquire new facilities,
- (ii) To determine expected cash flow from sales,
- (iii) To plan for future manpower requirements,
- (iv) To plan for material requirement,
- (v) To plan for Research and Development. Here much importance is given to long range growth factor.

In case of medium range forecasting the period may extend over to one or two years. The purpose of this type of forecasting is:

- (i) To determine budgetary control over expenses,
- (ii) To determine dividend policy,
- (iii) To find and control maintenance expenses,
- (iv) To determine schedule of operations,
- (v) To plan for capacity adjustments.

In case of short-term forecast, which extends from few weeks to three or six months and the following purposes are generally served:

- (i) To estimate the inventory requirement,
- (ii) To provide transport facilities for despatch of finished goods,
- (iii) To decide work loads for men and machines,
- (iv) To find the working capital needed,
- (v) To set-up of production run for the products,
- (vi) To fix sales quota,
- (vii) To find the required overtime to meet the delivery promises.

Everyone who use the forecast for one purpose or the other expects that they need that forecast should be accurate. But it is practically impossible to forecast accurately. But decisions are made everyday to run the business by using the best information available with them. Management scientists have developed various methods for forecasting. One has to decide which method has to be used to suit the information available with him and to suit his needs. The manager, who is concerned with forecasting, must have knowledge of factors influencing forecast. Various factors that influence the forecast are:

- (i) Environmental changes,
- (ii) Changes in the preference of the user,
- (iii) Number of competitive products,
- (iv) Disposable income of the consumer.



In forecasting the production important factors to be considered are:

- (i) Demand from the marketing department,
- (ii) Rate of labours absenteeism,
- (iii) Availability of materials,
- (iv) Available capacity of machines,
- (v) Maintenance schedules,
- (vi) Delivery date schedules.

Steps in forecasting

Whatever may be the method used for forecasting, the following steps are followed in forecasting.

- (a) **Determine the objective of forecast:** What for you are making forecast? Is it for predicting the demand? Is it to know the consumer's preferences? Is it to study the trend? You have to spell out clearly the use of forecast.
- (b) **Select the period over which the forecast will be made?** Is it long-term forecast or medium-term forecast or short-term forecast? What are your information needs over that period?
- (c) **Select the method you want to use for making the forecast.** This method depends on the period selected for the forecast and the information or data available on hand. It also depends on what you expect from the information you get from the forecast. Select appropriate method for making forecast.
- (d) **Gather information to be used in the forecast.** The data you use for making forecasting to produce the result, which is of great use to you. The data may be collected by:
 - (i) **Primary source:** This data we will get from the records of the firm itself.
 - (ii) **Secondary source:** This is available from outside means, such as published data, magazines, educational institutions etc.
- (e) **Make the forecast:** Using the data collected in the selected method of forecasting, the forecast is made.

Forecasting Methods:

Methods or techniques of sales forecasting: Different authorities on marketing and production have devised several methods or techniques of sales or demand forecasting. The sales forecasts may be result of what market people or buyers say about the product or they may be the result of statistical and quantitative techniques. The most common methods of sales forecasting are:

1. **Survey of buyer's intentions or the user's expectation method:** Under this system of sales forecasting actual users of the product of the concern are contacted directly and they are asked about their intention to buy the company's products in an expected given future usually a year. Total sales forecasts of the product then estimated on the basis of advice and willingness of various customers. This is most direct method of sales forecasting. The chief advantages of this method are:
 - (i) Sales forecast under this method is based on information received or collected from the actual users whose buying actions will really decide the future demand. So, the estimates are correct.
 - (ii) It provides a subjective feel of the market and of the thinking behind the buying intention of the actual uses. It may help the development of a new product in the market.
 - (iii) This method is more appropriate where users of the product are numbered and a new product is to be introduced for which no previous records can be made available.
 - (iv) It is most suitable for short-run forecasting.
2. **Collective opinion or sales force composite method:** Under this method, views of salesmen, branch manager, area manager and sales manager are secured for the different segments of the market. Salesmen, being close to actual users are required to estimate expected sales in their respective territories and sections. The estimates of individual salesmen are then consolidated to find out the total estimated sales for the coming session. These estimates are then further examined by the successive executive levels in the light of various factors like proposed changes in product design, advertising and selling prices, competition etc. before they are finally emerged for forecasting.



3. **Group executive judgement or executive judgement method:** This is a process of combining, averaging or evaluating, in some other way, the opinions and views of top executives. Opinions are sought from the executives of different fields i.e., marketing; finance; production etc. and forecasts are made.
4. **Experts' opinions:** Under this method, the organisation collects opinions from specialists in the field outside the organisation. Opinions of experts given in the newspapers and journals for the trade, wholesalers and distributors for company's products, agencies or professional experts are taken. By analysing these opinions and views of experts, deductions are made for the company's sales, and sales forecasts are done.
5. **Market test method:** Under this method seller sells his product in a part of the market for sometimes and makes the assessment of sales for the full market on the bases of results of test sales. This method is quite appropriate when the product is quite new in the market or good estimators are not available or where buyers do not prepare their purchase plan.
6. **Trend projection method:** Under this method, a trend of company's or industry's sales is fixed with the help of historical data relating to sales which are collected, observed or recorded at successive intervals of time. Such data is generally referred to as time series. The change in values of sales is found out. The study may show that the sales sometimes are increasing and sometimes decreasing, but a general trend in the long run will be either upward or downward. It cannot be both ways. This trend is called secular trend. The sales forecasts with the help of this method are made on the assumption that the same trend will continue in the future. The method which is generally used in fitting the trend is the method of least squares or straight line trend method. With this method a straight line trend is obtained. This line is called 'line of best fit'. By using the formula of regression equation of Y on X, the future sales are projected.

Calculation of trend.

The trend can be calculated by the least square method as follows:

- (i) Find time deviations (X) of each period from a certain period and then find the sum of time deviation ($\sum X$).
- (ii) Square the time deviation of each period (X^2) and then find the sum of squares of each period ($\sum X^2$).
- (iii) Multiply time deviations with the sales of each period individually (XY) and add the product of the column to find ($\sum XY$).
- (iv) To find the trend (Y) this is equal to $a + bX$. The value of a and b may be determined by either of the following two ways:

(a) **Direct method.** This method is applicable only when $\sum X = 0$. To make $\sum X = 0$, it is necessary that the time deviations should be calculated exactly from the mid point of the series. Then, the values of a and b will be calculated as follows:

$$a \text{ (average)} = \frac{\sum Y}{n} \text{ and } b \text{ (rate of growth)} = \frac{\sum XY}{\sum X^2}$$

This method is simple and direct.

(b) **Indirect method.** This method is somewhat difficult. This method can be applied in both the cases where $\sum X$ has any positive or negative values or $\sum X$ is not equal to zero. The values of a and b are calculated by solving the following two equations:

$$\sum Y = na + b\sum X$$

$$\sum XY = a\sum X + b\sum X^2$$

By calculating the values of a and b in the above manner, the sales can be forecasted for any future period by applying the formula $Y = a + bX$.

7. **Moving average method:** This is another statistical method to calculate the trend through moving averages. It can be calculated as follows:

An appropriate period is to be determined for which the moving average is calculated. While determining the period for moving averages, the normal cycle time of changes in the values of series should be considered so that short-term fluctuations are eliminated. As far as possible, the period for moving averages should be in odd numbers such as period of 3, 5 or 7 years. The period in even numbers will create a problem in centralising the values of averages. The calculated values of moving averages present the basis for determining the expected amount of sale.



- 8. Criteria of a good forecasting method:** It cannot be said which method of sales forecasting is the best because everyone has merits and demerits of its own. The suitability of a method depends on various factors such as nature of the product, available time and past records, wealth and energy, degree of accuracy and the forecaster etc. of an enterprise. However, in general, a good forecasting method must possess the following qualifications.
- Accuracy:** Accuracy of the forecasting figures is the life blood of the business because many important plans and programmes, policies and strategies are prepared and followed on the basis of such estimates. If sales forecasts are wrong, the businessmen suffer a big loss. Hence, the method of forecasting to be applied must amount to maximum accuracy.
 - Simplicity:** The method for forecasting should be very simple. If the method is difficult or technical, then there is every possibility of mistake. Some information are collected from outside and that will remain unanswered or inaccurate replies will be received, if the method is difficult. Management must also be able to understand and have confidence in the method.
 - Economy:** The method to be used should be economical taking into account the importance of the accuracy of forecast. Costs must be weighted against the importance of the forecast to the operations of the business.
 - Availability:** The method should be such for which the relevant information may be available immediately with reasonable accuracy. Moreover, the technique must give quick results and useful information to the management.
 - Stability:** The data of forecasting should be such wherein the future changes are expected to be minimum and are reliable for future planning for sometime.
 - Utility:** The forecasting technique must be easily understandable and suitable to the management.

Illustration 1.

From the following time series data of sale project the sales for the next three years.

Year	2001	2002	2003	2004	2005	2006	2007
Sales ('000 units)	80	90	92	83	94	99	92

Solution:

Computation of Trend Values

Years	Time Deviation from 2004 X	Sales in (₹'000 units) Y	Squares of time dev. X ²	Product of time deviations and sales XY
2001	-3	80	9	-240
2002	-2	90	4	-180
2003	-1	92	1	-92
2004	0	83	0	0
2005	+1	94	1	+94
2006	+2	99	4	+198
2007	+3	92	9	+276
n = 7	∑X = 0	∑Y = 630	∑X ² = 28	∑XY = + 56

Regression equation of Y on X

$$Y = a + bX$$

To find the values of a and b

$$a = \frac{\sum Y}{n} = \frac{630}{7} = 90$$

$$b = \frac{\sum XY}{\sum X^2} = \frac{56}{28} = 2$$



Hence regression equation comes to $Y = 90 + 2X$. With the help of this equation we can project the trend values for the next three years, i.e. 2008, 2009 and 2010.

$$Y_{2008} = 90 + 2(4) = 90 + 8 = 98 \text{ (000) units.}$$

$$Y_{2009} = 90 + 2(5) = 90 + 10 = 100 \text{ (000) units.}$$

$$Y_{2010} = 90 + 2(6) = 90 + 12 = 102 \text{ (000) units.}$$

Illustration 2.

With the help of following data project the trend of sales for the next five years:

Years	2002	2003	2004	2005	2006	2007
Sales (in lakhs)	100	110	115	120	135	140

Solution:

Computation of trend values of sales

Year	Time deviations from the middle of 2004 and 2005 assuming 6 months = 1 unit	Sales (in lakh ₹)	Squares of time deviation	Product of time deviation and sales
	X	Y	X ²	XY
2002	-5	100	25	-500
2003	-3	110	9	-330
2004	-1	115	1	-115
2005	+1	120	1	+120
2006	+3	135	9	+405
2007	+5	140	25	+700
n = 6	$\Sigma X = 0$	$\Sigma Y = 720$	$\Sigma X^2 = 70$	$\Sigma XY = 280$

Regression equation of Y on X:

$$Y = a + bX$$

To find the values of a and b

$$a = \frac{\Sigma Y}{n} = \frac{720}{6} = 120$$

$$b = \frac{\Sigma XY}{\Sigma X^2} = \frac{280}{70} = 4$$

Hence regression equation comes to $Y = 120 + 4X$

Sales forecast for the next years, i.e., 2008 to 2012

$$Y_{2008} = 120 + 4(+7) = 120 + 28 = ₹ 148 \text{ lakhs}$$

$$Y_{2009} = 120 + 4(+9) = 120 + 36 = ₹ 156 \text{ lakhs}$$

$$Y_{2010} = 120 + 4(+11) = 120 + 44 = ₹ 164 \text{ lakhs.}$$

$$Y_{2011} = 120 + 4(+13) = 120 + 52 = ₹ 172 \text{ lakhs.}$$

$$Y_{2012} = 120 + 4(+15) = 120 + 60 = ₹ 180 \text{ lakhs.}$$

Illustration 3.

An investigation into the demand for colour TV sets in 5 towns has resulted in the following data:

Population of the town (in lakhs)	X:	5	7	8	11	14
No of TV sets demanded (in thousands)	Y:	9	13	11	15	19

Fit a linear regression of Y on X and estimate the demand for CTV sets for two towns with a population of 10 lakhs and 20 lakhs.

Solution:**Computation of trend values**

Population (in lakhs)	Sales of CTV (in thousands)	Squares of the population	Product of population and sales of colour TV
X	Y	X ²	XY
5	9	25	45
7	13	49	91
8	11	64	88
11	15	121	165
14	19	196	266
$\Sigma X = 45$	$\Sigma y = 67$	$\Sigma X^2 = 455$	$\Sigma XY = 655$

Regression equation of Y on X

$$Y = a + bX$$

To find the values of a and b, the following two equations are to be solved

$$\Sigma Y = na + b\Sigma X \quad \dots (i)$$

$$\Sigma XY = a\Sigma X + b\Sigma X^2 \quad \dots (ii)$$

By putting the values we get

$$67 = 5a + 45b \quad \dots (iii)$$

$$655 = 45a + 455b \quad \dots (iv)$$

Multiplying equation (iii) by 9 and putting it as no. (v) we get,

$$603 = 45a + 405b \quad \dots (v)$$

By deducting equation (v) from equation (iv); we get $52 = 50b$

$$b = \frac{52}{50} = 1.04$$

By putting the value of b in equation (iii), we get

$$67 = 5a + 45 \times 1.04$$

or, $67 = 5a + 46.80$

or, $67 - 46.80 = 5a$

or, $5a = 20.20$

or, $a = \frac{20.20}{5}$

or, $a = 4.04$

Now by putting the values of a and b the required regression equation of Y on X, is

$$Y = a + bX \quad \text{or, } Y = 4.04 + 1.04X$$



When $X = 10$ lakhs then

$$Y = 4.04 + 1.04 (10)$$

or, $Y = 4.04 + 10.40$ or 14.44 thousand CTV sets.

Similarly for town having population of 20 lakhs, by putting the value of $X = 20$ lakhs in regression equation

$$\begin{aligned} Y &= 4.04 + 1.04 (20) \\ &= 4.04 + 20.80 = 24.84 \text{ thousands CTV sets.} \end{aligned}$$

Hence expected demand for CTV for two towns will be 14.44 thousand and 24.84 thousand CTV sets.

Illustration 4.

An investigation into the use of scooters in 5 towns has resulted in the following data: Population in town

Population in town (in lakhs)	(X)	4	6	7	10	13
No. of scooters	(Y)	4,400	6,600	5,700	8,000	10,300

Fit a linear regression of Y on X and estimate the number of scooters to be found in a town with a population of 16 lakhs.

Solution:

Computation of trend value

Population (in lakhs) X	No. of scooters demanded Y	Squares of population X^2	Product of population and No. of scooters demanded XY
4	4,400	16	17,600
6	6,600	36	39,600
7	5,700	49	39,900
10	8,000	100	80,000
13	10,300	169	1,33,900
$\Sigma X = 40$	$\Sigma Y = 35,000$	$\Sigma X^2 = 370$	$\Sigma XY = 3,11,000$

Regression equation of Y on X

$$Y = a + bX$$

To find the values of a and b we will have to solve the following two equations

$$\Sigma Y = na + b\Sigma X \quad \dots (i)$$

$$\Sigma XY = a\Sigma X + b\Sigma X^2 \quad \dots (ii)$$

By putting the values, we get

$$35,000 = 5a + 40b \quad \dots (iii)$$

$$3,11,000 = 40a + 370b \quad \dots (iv)$$

By multiplying equation no. (iii) by 8 putting as equation (v) we get,

$$2,80,000 = 40a + 320b \quad \dots (v)$$

By subtracting equation (v) from equation (iv), we get

$$31,000 = 50b$$

or, $50b = 31,000$

or, $b = \frac{31000}{50} = 620$



By substituting the value of b in equation no. (iii), we get

$$35,000 = 5a + 40b$$

or $35,000 = 5a + 40 \times 620$

or $35,000 = 5a + 24,800$

or $10,200 = 5a$

or $a = \frac{10200}{5} = 2040$

Now putting the values of a and b the required regression equation of Y on X, is

$$Y = a + bX \quad \text{or, } Y = 2040 + 620 X$$

When X = 16 lakhs then $Y = 2040 + 620 (16)$

or $Y = 2040 + 9920$

or $Y = 11,960$

Hence, the expected demand of scooters for a town with a population of 16 lakhs will be 11,960 scooters.

2.2 CAPACITY PLANNING

Capacity Planning:

The effective management of capacity is the most important responsibility of production and operations management. The objective of capacity management i.e., planning and control of capacity, is to match the level of operations to the level of demand.

Capacity planning is concerned with finding answers to the basic questions regarding capacity such as:

- (i) What kind of capacity is needed?
- (ii) How much capacity is needed?
- (iii) When this capacity is needed?

Capacity planning is to be carried out keeping in mind future growth and expansion plans, market trends, sales forecasting, etc. Capacity is the rate of productive capability of a facility. Capacity is usually expressed as volume of output per period of time.

Capacity planning is required for the following:

- Sufficient capacity is required to meet the customers demand in time,
- Capacity affects the cost efficiency of operations,
- Capacity affects the scheduling system,
- Capacity creation requires an investment,
- Capacity planning is the first step when an organisation decides to produce more or new products.

Capacity planning is mainly of two types:

- (i) **Long-term capacity plans** which are concerned with investments in new facilities and equipments. These plans cover a time horizon of more than two years.
- (ii) **Short-term capacity plans** which takes into account work-force size, overtime budgets, inventories etc.

Capacity refers to the maximum load an operating unit can handle. The operating unit might be a plant, a department, a machine, a store or a worker. Capacity of a plant is the maximum rate of output (goods or services) the plant can produce.



The production capacity of a facility or a firm is the maximum rate of production the facility or the firm is capable of producing. It is usually expressed as volume of output per period of time (i.e., hour, day, week, month, quarter etc.). Capacity indicates the ability of a firm to meet market demand - both current and future.

Effective Capacity can be determined by giving due consideration to the following factors:

Facilities - design, location, layout and environment.

Product - Product design and product-mix.

Process - Quantity and quality capabilities of the process or to be followed.

Human factors - Job content, Job design, motivation, compensation, training and experience of labour, learning rates and absenteeism and labour turn over.

Operational factors - Scheduling, materials management, quality assurance, maintenance policies, and equipment break-downs.

External factors - Product standards, safety regulations, union attitudes, pollution control standards.

Measurement of capacity

Capacity of a plant is usually expressed as the rate of output, i.e., in terms of units produced per period of time (i.e., hour, shift, day, week, month etc.). But when firms are producing different types of products, it is difficult to use volume of output of each product to express the capacity of the firm. In such cases, capacity of the firm is expressed in terms of monetary value (production value) of the various products produced put together.

Capacity Planning Decisions

Capacity planning involves activities such as:

- (i) Assessing the capacity of existing facilities.
- (ii) Forecasting the long-range future capacity needs.
- (iii) Identifying and analysing sources of capacity for future needs.
- (iv) Evaluating the alternative sources of capacity based on financial, technological and economical considerations.
- (v) Selecting a capacity alternative most suited to achieve strategic mission of the firm.

Capacity planning is necessary when an organisation decides to increase its production or introduce new products into the market or to increase the volume of production to gain the advantages of economies of scale. Once the existing capacity is evaluated and a need for new or expanded facilities is determined, decisions regarding the facility location and process technology selection are undertaken.

When the long-range capacity needs are estimated through long-range forecasts for products, a firm may find itself in one of the two following situations:

- (i) A capacity shortage situation where present capacity is not enough to meet the forecast demand for the product.
- (ii) An excess or surplus capacity situation where the present capacity exceeds the expected future demand.

Factors affecting determination of plant capacity

- (i) Capital investment required,
- (ii) Changes in product design, process design, market conditions and product life cycles,
- (iii) Flexibility for capacity additions,
- (iv) Level of automation desired,
- (v) Market demand for the product,



- (vi) Product obsolescence and technology obsolescence and
- (vii) Type of technology selected.

Forms of capacity planning:

Based on time-horizon

- (i) Long-term capacity planning and
- (ii) Short-term capacity planning

Based on amount of resources employed

- (i) Finite capacity planning and
- (ii) Infinite capacity planning

Factors Affecting Capacity Planning: Two kinds of factors affecting capacity planning are:

- (i) **Controllable Factors:** amount of labour employed, facilities installed, machines, tooling, shifts of work per day, days worked per week, overtime work, subcontracting, preventive maintenance and number of production set ups.
- (ii) **Less Controllable Factors:** absenteeism, labour performance, machine break-downs, material shortages, scrap and rework, strike, lock-out, fire accidents, natural calamities (flood, earthquake etc.) etc.

2.3 CAPACITY REQUIREMENT

Capacity Requirement Planning : Capacity requirement planning (CRP) is a technique which determines what equipment and labour/personnel capacities are required to meet the production objectives (i.e., volume of products) as per the master production schedule and material requirement planning (MRP-I).

Capacity Requirement Planning Strategies:

Two types of capacity planning strategies used are:

- (i) **“Level capacity” plan and**
- (ii) **“Matching capacity with demand” plan.**

“Level capacity” plan is based in “produce-to-stock and sell” approaches wherein the production systems are operated at uniform production levels and finished goods inventories rise and fall depending upon whether production level exceeds demand or vice versa from time period to time period (say every quarter).

“Matching capacity with demand” Plan: In this plan, production capacity is matched with the demand in each period (weekly, monthly or quarterly demand). Usually, material flows and machine capacity are changed from quarter to quarter to match the demand. The main advantages are low levels of finished goods inventory resulting in lesser inventory carrying costs. Also, the back-ordering cost is reduced. The disadvantages are high labour and material costs because of frequent changes in workforce (hiring, training and lay-off costs, overtime or idle time cost or subcontracting costs).

Optimum Plant Capacity: Plant capacity has a great influence on cost of production with increasing volume of production, economies of scale arises which results in reduction in average cost per unit produced.

For a given production facility, there is an optimum volume of output per year that results in the least average unit cost. This level of output is called the “best operating level” of the plant.

As the volume of output increases outward from zero in a particular production facility, average unit costs fall. These declining costs are because of the following reasons: (i) Fixed costs are spread over more units produced, (ii) Plant construction costs are less, (iii) Reduced costs of purchased material due to quantity discounts for higher volume of materials purchased and (iv) Cost advantages in mass production processes. Longer production runs (i.e., higher batch quantity of products produced) have lesser setup cost per unit of product produced, lesser scrap etc., resulting in savings which will reduce the cost of production per unit. This is referred to as “economies of scale”. But this reduction in per unit cost will be only upto certain volume of production. Additional volumes of



outputs beyond this volume results in ever-increasing average unit production cost. This increase in cost per unit arise from increased congestion of materials and workers, which decreases efficiency of production, and due to other factors such as difficulty in scheduling, damaged products, reduced employee morale due to excessive work pressure, increased use of overtime etc., resulting in "diseconomies of scale". Hence, the plant capacity should be such that the optimum level of production which gives the minimum average cost of production per unit should be possible. This plant capacity is referred to as optimum plant capacity.

Balancing the Capacity: In firms manufacturing many products (a product line or a product-mix) the load on different machines and equipments vary due to changes in product-mix. When the output rates of different machines do not match with the required output rate for the products to be produced, there will be an imbalance between the work loads of different machines. This will result in some machine or equipment becoming a "bottleneck work centre" thereby limiting the plant capacity which will in-turn increase the production costs per unit.

To overcome problem of imbalance between different machines, additional machines or equipments are added to the bottleneck work-centre to increase the capacity of the bottle-neck work centre to match with the capacity of other work centres. Adding new machines or equipments to bottleneck work centres to remove the imbalance in capacity between various work centres is found to be economical than giving excessive overtime to workers working in bottle-neck centres which increases production costs. Another method to remove imbalance is to subcontract excess work load of bottleneck centres to outside vendors or subcontractors. Another way to balance capacities is to try to change the productmix by manipulating the sales for different products to arrive at a suitable product-mix which loads all work centres almost uniformly.

Implications of Plant Capacity

There are two major cost implications of plant capacity:

- (i) Changes in output of an existing plant of certain installed capacity affect the production costs.
- (ii) Changes in the plant capacity by changing the size of a plant have significant effects on costs.

Factors influencing Effective Capacity

The effective capacity is influenced by – (1) Forecasts of demand, (2) Plant and labour efficiency, (3) Subcontracting, (4) Multiple shift operation, (5) Management policies.

Forecasts of demand: Demand forecast is going to influence the capacity plan in a significant way. As such, it is very difficult to forecast the demand with accuracy as it changes significantly with the product life-cycle stage, number of products. Products with longer lifecycle usually exhibit steady demand growth compared to one with shorter life-cycle. Thus the accuracy of forecast influences the capacity planning.

Plant and labour efficiency: It is difficult to attain 100 per cent efficiency of plant and equipment. The efficiency is less than 100 percent because of the enforced idle time due to machine breakdown, delays due to scheduling and other reasons. The plant efficiency varies from equipment to equipment and from organisation to organisation. Labour efficiency contributes to the overall capacity utilisation. The standard time set by industrial engineer is for a representative or normal worker. But the actual workers differ in their speed and efficiency. The actual efficiency of the labour should be considered for calculating efficiency. Thus plant and labour efficiency are very much essential to arrive at realistic capacity planning.

Subcontracting: Subcontracting refers to off loading, some of the jobs to outside vendors thus hiring the capacity to meet the requirements of the organisation. A careful analysis as to whether to make or to buy should be done. An economic comparison between cost to make the component or buy the component is to be made to take the decision.

Multiple shift operation: Multiple shifts are going to enhance the firm's capacity utilisation. But especially in the third shift the rejection rate is higher. Specially for process industries where investment is very high it is recommended to have a multiple shifts.

Management policy: The management policy with regards to subcontracting, multiplicity of shifts (decision regarding how many shifts to operate), which work stations or departments to be run for third shift, machine replacement policy, etc., are going to affect the capacity planning.



Factors favouring over capacity and under capacity

It is very difficult to forecast demand as always there is an uncertainty associated with the demand. The forecasted demand will be either higher or lower than the actual demand. So always there is a risk involved in creating capacity based on projected demand. This gives rise to either over capacity or under capacity.

The over capacity is preferred when:

- Fixed cost of the capacity is not very high.
- Subcontracting is not possible because of secrecy of design and/or quality requirement.
- The time required to add capacity is long.
- The company cannot afford to miss the stipulated delivery date and cannot afford to lose the customer.
- There is an economic capacity size below which it is not economical to operate the plant.

The under capacity is preferred when:

- Fixed cost of the capacity is very high.
- Shortage of products does not affect the company (i.e., lost sales can be compensated).
- The technology changes fast, i.e., the rate of obsolescence of plant and equipment are high.
- The cost of creating the capacity is prohibitively high.

Illustration 5.

A department works on 8 hours shift, 250 days a year and has the usage data of a machine, as given below:

Product	Annual demand (units)	Processing time (standard time in hours)
X	300	4.0
Y	400	6.0
Z	500	3.0

Determine the number of machines required.

Solution:

Step 1: Calculate the processing time needed in hours to produce product x, y and z in the quantities demanded using the standard time data.

Product	Annual demand (units)	Standard processing time per unit (Hrs.)	Processing time needed (Hrs.)
X	300	4.0	300 x 4 = 1200 Hrs.
Y	400	6.0	400 x 6 = 2400 Hrs.
Z	500	3.0	500 x 3 = 1500 Hrs.
			Total = 5100 Hrs

Step 2 : Annual production capacity of one machine in standard hours = 8 × 250 = 2000 hours per year

Step 3 : Number of machines required

$$= \frac{\text{Work load per year}}{\text{Production capacity per machine}} = \frac{5100}{2000} = 2.55 \text{ machines} = 3 \text{ machines.}$$

Illustration 6.

A steel plant has a design capacity of 50,000 tons of steel per day, effective capacity of 40,000 tons of steel per day and an actual output of 36,000 tons of steel per day. Compute the efficiency of the plant and its utilisation.



Solution:

Actual output

$$\text{Efficiency of the plant} = \frac{\text{Actual output}}{\text{Effective Capacity}} = \left(\frac{36000}{40000} \right) \times 100 = 90\%$$

$$\text{Utilisation} = \left(\frac{\text{Actual output}}{\text{Design Capacity}} \right) = \left(\frac{36000}{50000} \right) \times 100 = 72\%$$

Illustration 7.

A firm has four work centres, A, B, C & D, in series with individual capacities in units per day shown in the figure below.

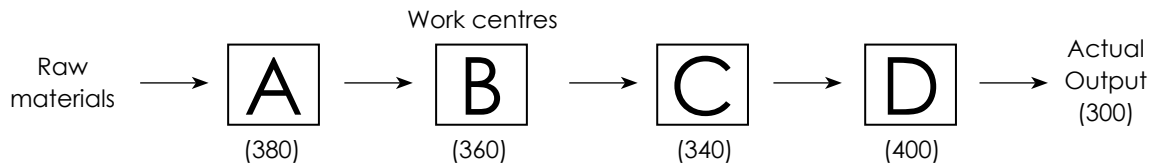

- (i) Identify the bottle neck centre.
- (ii) What is the system capacity?
- (iii) What is the system efficiency?

Solution:

- (i) The bottle neck centre is the work centre having the minimum capacity. Hence, work centre 'C' is the bottleneck centre.
- (ii) System capacity is the maximum units that are possible to produce in the system as a whole. Hence, system capacity is the capacity of the bottle neck centre i.e., 340 units.

(iii) System efficiency = $\frac{\text{Actual output}}{\text{System capacity}}$

$$= \frac{300}{340} \times 100 \text{ (i.e., maximum possible output)} = 88.23\%$$

Illustration 8.

A manager has to decide about the number of machines to be purchased. He has three options i.e., purchasing one, or two or three machines. The data are given below.

Number of machine	Annual fixed cost	Corresponding range of output
One	₹ 12,000	0 to 300
Two	₹ 15,000	301 to 600
Three	₹ 21,000	601 to 900

Variable cost is ₹ 20 per unit and revenue is ₹ 50 per unit

- (a) Determine the break-even point for each range
- (b) If projected demand is between 600 and 650 units how many machines should the manager purchase?

Solution:

- (i) Break-even point

Let Q be the break even point.

FC = Fixed cost, R = Revenue per unit, VC = Variable cost



$$\begin{aligned} \text{At,} & \quad \text{BEP, TR} = \text{FC} + \text{TVC} \\ \text{or,} & \quad \text{Revenue p.u} \times Q = \text{FC} + \text{VC}_{\text{p.u.}} \times Q \\ & \quad Q (R - \text{VC}) = \text{FC} \\ & \quad Q = \frac{\text{FC}}{R - \text{VC}} \end{aligned}$$

Let Q1 be the break-even-point for one machine option

$$\text{Then, } Q1 = \frac{12000}{(50 - 20)} = \frac{12000}{30} = 400 \text{ units}$$

(Not within the range of 0 to 300)

Let Q2 be the break-even-point for two machines option.

$$\text{Then, } Q2 = \frac{15000}{(50 - 20)} = \frac{15000}{30} = 500 \text{ units}$$

(within the range of 301 to 600)

Let Q3 be the break-even-point for three machines option.

$$\text{Then, } Q3 = \frac{21000}{(50 - 20)} = \frac{21000}{30} = 700 \text{ units}$$

(with in the range of 601 to 900)

(ii) The projected demand is between 600 to 650 units.

The break even point for single machine option (i.e., 400 units) is not feasible because it exceeds the range of volume that can be produced with one machine (i.e., 0 to 300).

Also, the break even point for 3 machines is 700 units which is more than the upper limit of projected demand of 600 to 650 units and hence not feasible. For 2 machines option the break even volume is 500 units and volume range is 301 to 600.

Hence, the demand of 600 can be met with 2 machines and profit is earned because the production volume of 600 is more than the break even volume of 500. If the manager wants to produce 650 units with 3 machines, there will be loss because the break even volume with three machines is 700 units. Hence, the manager would choose two machines and produce 600 units.

2.4 FACILITY LOCATION

Plant location may be understood as the function of determining where the plant should be located for maximum operating economy and effectiveness. The selection of a place for locating a plant is one of the problems, perhaps the most important, which is faced by an entrepreneur while launching a new enterprise. A selection on pure economic considerations will ensure an easy and regular supply of raw materials, labour force, efficient plant layout, proper utilisation of production capacity and reduced cost of production. An ideal location may not, by itself, guarantee success; but it certainly contributes to the smooth and efficient working of an organisation. A bad location, on the other hand, is a severe handicap for any enterprise and it finally bankrupts it. It is, therefore, very essential that utmost care should be exercised in the initial stages to select a proper place. Once a mistake is made in locating a plant it becomes extremely difficult and costly to correct it.

Steps in Location Selection

To be systematic, in choosing a plant location, the entrepreneur would do well to proceed step by step, the steps be:

1. Within the country or outside;
2. Selection of the region;
3. Selection of the locality or community;
4. Selection of the exact site.



1. Deciding on Domestic or International Location

The first step in plant location is to decide whether the facility should be located domestically or internationally. A few years ago, this factor would have received little consideration. But with increasing internationalisation of business, the issue of home or foreign country' is gaining greater relevance. If the management decides on foreign location, the next logical step would be to decide upon a particular country for location. This is necessary because, countries across the world are vying with each other to attract foreign investments. The choice of a particular country depends on such factors as political stability, export and import quotas, currency and exchange rates, cultural and economic peculiarities, and natural or physical conditions.

2. Selection of Region

The selection of a particular region out of the many natural regions of a country is the second step in plant location. The following factors influence such selection:

(i) Availability of Raw Materials

As a manufacturing unit is engaged in the conversion of raw materials into finished products, it is very essential that it should be located in a place where the supply of raw materials is assured at minimum transport cost. The sugar industry, the paper industry, the iron and steel industry, the industries engaged in the solvent extraction of oil from rice bran, the China clay washery, factories manufacturing low tension porcelain insulators, and the like should be located near the sources of their raw materials. The heavy concentration of the sugar industry in Bihar and Uttar Pradesh is due to the fact that these two States are the leading producers of sugarcane in the country.

Nearness to raw materials offers such advantages as:

- (a) Reduced cost of transportation;
- (a) Regular and proper supply of materials uninterrupted by transportation breakdowns; and
- (c) Savings in the cost of storage of materials.

(ii) Nearness to the Market

Since goods are produced for sale, it is very essential that the factory should be located near their market. A reduction in the cost of transporting finished goods to the market; the ability to adjust the production programme to suit the likes and dislikes of consumers; the ability to render prompt service to the consumers, provide after-sale services, and execute replacement orders without delay - these are some of the advantages that accrue to the entrepreneur if he/she establishes his/her factory near his market.

(iii) Availability of Power

Power is essential to move the wheels of an industry. Coal, electricity, oil and natural gas are the sources of power. Where coal is the source of power, as in the case of the iron and steel industry, the factory has to be located near the coal fields. Examples of such industries are: the iron and steel industry in Germany, in Pennsylvania in the U.S.A. and in Jamshedpur in India.

(iv) Transport Facilities

While making a study of a location, an entrepreneur considers the question of the availability of transport facilities. Transport facilities are essential for bringing raw materials and men to the factory and for carrying the finished products from the factory to the market. A place which is well connected by rail, road and water transport is ideal for a plant location. It may be said that industry follows transportation. In other words, places with well-developed means of transport attract industries. In extreme cases, transport may follow industries. For instance, if a public sector unit is started in a remote place, the Government will naturally provide transport facilities to cater to the requirements of the unit. But, generally speaking a place with existing transport facilities is perfect for locating a plant.

(v) Suitability of Climate

The climate has its own importance in the location of a plant because of two reasons. First, there are certain industries which, because of the nature of their production, require particular climatic conditions; for example,



humid climate for cotton textiles and jute. Such industries have to be located in places where humid climatic conditions are available. This explains why the cotton textile industry is concentrated in Mumbai and the jute textile industry in Kolkata.

(vi) Government Policy

The influence of Government policies and programmes on plant location is apparent in every country, particularly in planned economies like ours. In the name of balanced regional development, many backward regions in India have been selected for the location of new industries, which would generate the regions economy and on a larger canvas, the national economy.

The Government of India has been influencing plant location in a number of ways. Some of these are:

Licensing policy;

Freight rate policy;

Establishing a unit in the public sector in a remote area and developing it to attract other industries;

Institutional finance and government subsidies.

3. Selection of Community

Selecting a particular locality or community in a region is the third step in plant location. The selection of a locality in a particular region is influenced by the following factors:

(i) Availability of Labour

Despite the talk of mechanisation and automation, the importance of labour in the industrial side has not been completely lost. Labour is an important factor in the production of goods. An adequacy of labour supply at reasonable wages is very essential for the smooth and successful working of an organisation.

(ii) Civic Amenities for Workers

Besides good working conditions inside the factory, the employees require certain facilities outside it. Recreation facilities, such as clubs, theatres and parks, must be provided for the employees. They require schools for their children. A place which abounds in all these facilities will naturally be preferred to another place which lacks them.

(iii) Existence of Complementary and Competing Industries

The existence of complementary industries is favourable to the location of industries because an industrial unit, in association with other units, can get the following benefits:

- An industrial unit, in collaboration with other similar units, can secure materials on better terms than it can do it by itself. The concentration of such similar establishments helps to increase the variety of materials that can be offered by suppliers.

(iv) Availability of Water and Fire-fighting Facilities

Some industries require a plentiful supply of water for their working. Some of these are: fertilizer units, rayon manufacturing units, absorbent cotton manufacturing units, leather tanneries, bleaching, dyeing and screen printing units. These factories must be located in places where water is available in abundance. Water may be obtained from the local authority, from the canal, from a river or a lake, or by sinking a borewell. In any case, the supply of water should be considered with respect to its regularity, cost and purity.

4. Selection of the Site

The selection of an exact site in a chosen locality is the fourth step in plant location. The selection of the site is influenced by the following considerations:

Soil, Size and Topography

For factories producing engineering goods, the fertility or otherwise of the soil may not be a factor influencing plant location. But for agro-based industries, a fertile soil is necessary for ensuring a strategic plant location.

The area of the land should be such as to accommodate not only the existing manufacturing facilities, but offer scope for future expansion programmes as well.



2.5 FACILITY LAYOUT

Plant Layout, also known as layout of facility refers to the configuration of departments, work-centres and equipment and machinery with focus on the flow of materials or work through the production system.

Plant layout or facility layout means planning for location of all machines, equipments, utilities, work stations, customer service areas, material storage areas, tool servicing areas, tool cribs, aisles, rest rooms, lunch rooms, coffee/tea bays, offices, and computer rooms and also planning for the patterns of flow of materials and people around, into and within the buildings. Layout planning involves decisions about the physical arrangement of economic activity centres within a facility. An economic activity centre can be anything that consumes space, a person or group of people, a machine, a work station, a department, a store room and so on. The goal of layout planning is to allow workers and equipments to operate more effectively.

The questions to be addressed in layout planning are:

- How much space and capacity does each centre need?
- How should each center's space be configured?
- What centres should the layout include?
- Where should each centre be located?

The location of a centre has two dimensions:

- Absolute location or the particular space that the centre occupies within the facility.
- Relative location i.e., the placement of a centre relative to other centers.

The importance of layout decisions:

The need for layout planning arises both in the process of designing new plants and the redesigning existing plants or facilities.

Most common reasons for design of new layouts are:

- (i) Layout is one of the key decisions that determine the long-run efficiency in operations.
- (ii) Layout has many strategic implications because it establishes an organisation's competitive priorities in regard to capacity, processes, flexibility and cost as well as quality of work life, customer contact and image (in case of service organisations).
- (iii) An effective layout can help an organisation to achieve a strategic advantage that supports differentiation, low cost, fast response or flexibility.
- (iv) A well designed layout provides an economic layout that will meet the firm's competitive requirements.

Need for redesign of layout arises because of the following reasons:

- Accidents, health hazards and low safety,
- Changes in environmental or legal requirements,
- Changes in processes, methods or equipments,
- Changes in product design/service design,
- Changes in volume of output or product-mix changes,
- Inefficient operations (high cost, bottleneck operations),
- Introduction of new products/services,
- Low employee morale.

**Good Plant layout- Objectives:**

- Efficient utilisation of labour reduced idle time of labour and equipments,
- Higher flexibility (to change the layout easily),
- Higher utilisation of space, equipment and people (employees),
- Improved employee morale and safe working conditions,
- Improved flow of materials, information and people (employees),
- Improved production capacity,
- Reduced congestion or reduced bottleneck centers,
- Reduced health hazards and accidents,
- To allow ease of maintenance,
- To facilitate better coordination and face-to-face communication where needed,
- To improve productivity,
- To provide ease of supervision,
- To provide product flexibility and volume flexibility,
- To utilise available space efficiently and effectively.

Choices of Layout:

Layout choices can help greatly in communicating an organisation's product plans and competitive priorities. Layout has many practical and strategic implications. Altering a layout can affect an organisation and how well it meets its competitive priorities by:

- Facilitating the flow of materials and information,
- Improving communication,
- Improving employee morale,
- Increasing customer convenience and sales (in service organisations such as retail stores),
- Increasing the efficient utilisation of labour and equipment,
- Reducing hazards to employees.

The type of operations carried out in a firm determines the layout requirements.

Some of the fundamental layout choices available to managers are:

- Whether to plan the layout for the current or future needs?
- Whether to select a single-story or multistory building design?
- What type of layout to choose?
- What performance criteria to emphasise?

Factors influencing layout choices:

Primarily the layout of a plant is influenced by the relationship among materials, machinery and men. Other factors influencing layout are type of product, type of workers, the type of industry, management policies etc.

Some of these factors are discussed in detailed below:

- **Location:** The size and type of the site selected for the plant, influences the type of buildings (single story or multi story) which in turn influences the layout design. Also, the location of the plant determines the mode of transportation from and into the plant (such as by goods trains, truck, or ships) and the layout should provide facilities for mode of transport used. Also, the layout should provide for storage of fuel, raw materials, future expansion needs, power generation requirements etc.

- **Machinery and Equipments:** The type of product, the volume of production, type of processes and management policy on technology, determines the type of machines and equipments to be installed
- **Managerial Policies:** regarding volume of production, provision for future expansion, extent of automation, make-or-buy decisions, speed of delivery of goods to customers, purchasing and inventory policies and personnel policies influence the plant layout design.
- **Materials:** Plant layout includes provision for storage and handling of raw materials, supplies and components used in production. The type of storage areas, racks, handling equipments such as cranes, trolleys, conveyors or pipelines etc., used - all depend on the type of materials used - such as solid, liquid, light, heavy, bulky, big, small etc.
- **Product:** The type of product i.e., whether the product is light or heavy, big or small, liquid or solid etc., it influences the type of layout. For example, Ship building, Aircraft assembly, Locomotive assembly etc., requires a layout type different from that needed to produce refrigerators, cars, scooters, television sets, soaps, detergents, soft drinks etc. The manufacturing process equipments and machines used and the processing steps largely depend on the nature of the product and hence the layout design depends, very much on the product.

Type of Industry:

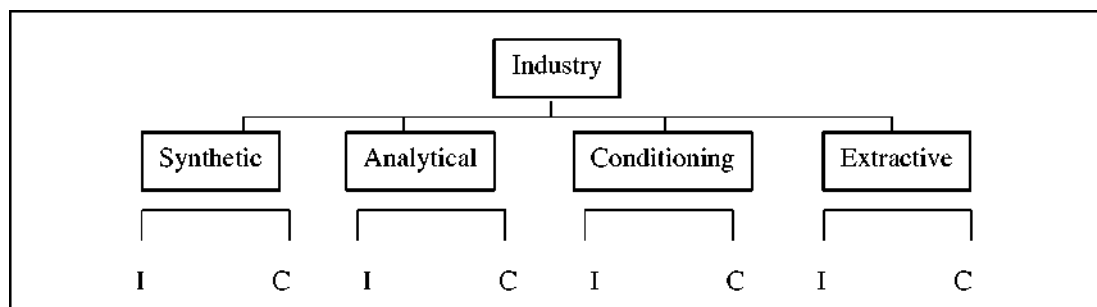

Type of Industry Process

I is intermittent type of industry

C is continuous type of industry

Whether the industry is classified under (a) Synthetic, (b) Analytical, (c) Conditioning and (d) Extraction industries and again whether the industry has intermittent production or continuous production has a relevance to the type of layout employed.

- **Workers :** The gender of employees (men or women), the position of employees while working (i.e., standing or sitting), employee facilities needed such as locker rooms, rest rooms, toilets, canteens, coffee/tea bays etc., are to be considered while designing the plant layouts.

Plant Layout- Principles:

The layout selected in conformity with layout principles should be an ideal one. These principles are:-

- **Principle of Minimum Travel:** Men and materials should travel the shortest distance between operations so as to avoid waste of labour and time and minimise the cost of materials handling.
- **Principle of Sequence:** Machinery and operations should be arranged in a sequential order. This principle is best achieved in product layout, and efforts should be made to have it adopted in the process layout.
- **Principle of Usage:** Every unit of available space should be effectively utilised.
- **Principle of Compactness:** There should be a harmonious fusion of all the relevant factors so that the final layout looks well integrated and compact.



- **Principle of Safety and Satisfaction:** The layout should contain built in provisions for safety for the workmen. It should also be planned on the basis of the comfort and convenience of the workmen so that they feel satisfied.
- **Principle of Flexibility:** The layout should permit revisions with the least difficulty and at minimum cost.
- **Principle of Minimum Investment:** The layout should result in savings in fixed capital investment, not by avoiding installation of the necessary facilities but by an intensive, use of available facilities.

Types of Layout:

A layout essentially refers to the arranging and grouping of machines which are meant to produce goods. Grouping is done on different lines. The choice of a particular line depends on several factors. The methods of grouping or the types of layout are:

(i) Process layout or functional layout or job shop layout; (ii) Product layout or line processing layout or flow-line layout; (iii) Fixed position layout or static layout; (iv) Cellular manufacturing (CM) layout or Group Technology layout and (v) Combination layout or Hybrid layout.

Process Layout:

Also called the functional layout, layout for job lot manufacture or batch production layout, the process layout involves a grouping together of similar machines in one department. For example, machines performing drilling operations are installed in the drilling department; machines performing turning operations are grouped in the turning department; and so on. In this way, there would be an electroplating department, a painting department, a machining departments and the like, where similar machines or equipments are installed in the plants which follow the process layout. The process arrangement is signified by the grouping together of like machines based upon their operational characteristics. For example, centre lathes will be arranged in one department, turret lathes in a second department, and milling machines in a third departments.

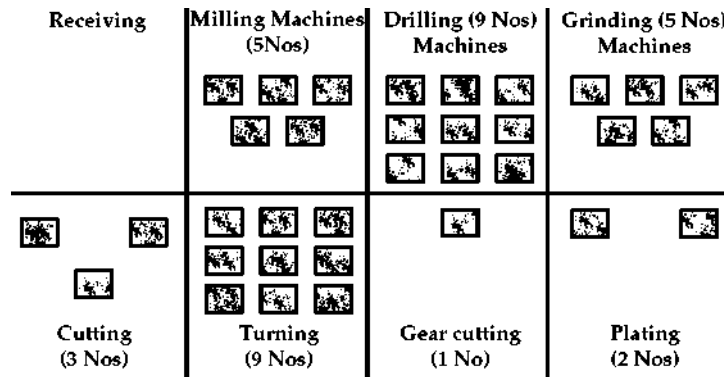

A quantity of raw material is issued to a machine which performs the first operation. This machine may be situated anywhere in the factory. For the next operation, a different machine may be required, which may be situated in another part of the factory. The material should be transported to the other machine for the operation. Thus, material would move long distances and along crisscrossing paths. At one stage, the material may be taken to a separate building, say, for heat treatment, and then brought back for grinding. If machines in one department are engaged, the partly finished product awaiting operations may be taken to the store and later reissued for production. Partly finished goods would be waiting for processing in every department, like commuters waiting for buses in a city.

Machines in each department attend to any product that is taken to them. These machines are, therefore, called general purpose machines. Work has to be allotted to each department in such a way that no machine in any department is idle. In a batch production layout, machines are chosen to do as many different jobs as possible, i.e., the emphasis is on general purpose machines. The work which needs to be done is allocated to the machines

according to loading schedules, with the objective of ensuring that each machine is fully loaded. The process layout carries out the functional idea of Taylor and from the historical point of view, process layout precedes product layout. This type of layout is best suited for intermittent type of production.

While grouping machines according to the process type, certain principles must be kept in mind. These are:

- Convenience for inspection.
- Convenience for supervision. Process layout may be advantageously used in light and heavy engineering industries, made-to-order furniture industries and the like.
- The distance between departments needs to be as short as possible with a view to avoiding long distance movement of materials.
- Though similar machines are grouped in one department, the departments themselves should be located in accordance with the principle of sequence of operations. For example, in a steel plant, the operations are smelting, casting; rolling etc. These different departments may be arranged in that order to avoid crossovers and backtracking of materials.

Product Layout:

Also called the straight-line layout or layout for serialised manufacture. The product layout involves the arrangement of machines in one line depending upon the sequence of operations. Material is fed into the first machine and finished products come out of the last machine. In between, partly finished goods move from machine to machine. The output of one machine becoming the input for the next. In a sugar mill, sugar cane, fed at one end of the mill comes out as sugar at the other end. Similarly, in paper mill, bamboos are fed into the machine at one end and paper comes out at the other end.

In product layout, if there are more than one, line of production, there are as many, lines of machines. The emphasis here, therefore, is on special purpose machines in contrast to general purpose machines, which are installed in the process layout. Consequently, the investment on machines in a straight line layout is higher than the investment on machines in a functional layout.

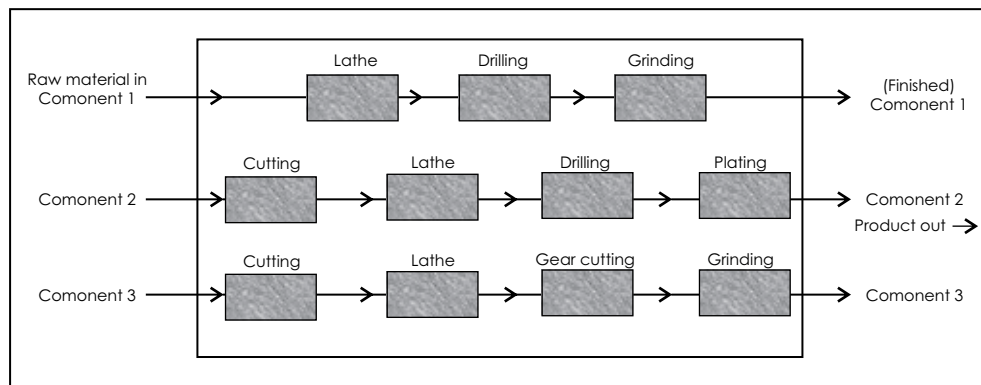

Figure of Product Layout

The grouping of machines should be done, on product line, keeping in mind the following principles:

- All the machine tools or other types of equipment must be placed at the point demanded by the sequence of operations.
- All the operations, including assembly, testing and packing should be, included in the line.
- Materials may be fed where they are required for assembly but not necessarily all at one point; and
- There should be no points where one line crosses another line;

The product layout may be advantageously followed in plants manufacturing standardised products on a mass scale such as chemical, paper, sugar, rubber, refineries and cement industries.

Layout in the form of Fixed Position:

As the term itself implies, the fixed position layout involves the movement of men and machines to the product which remains stationary. In this type of layout, the material or major component remains in a fixed location, and tools, machinery and men as well as other pieces of material are brought to this location. The movement of men and machines to the product is advisable because the cost of moving them would be less than the cost of moving the product which is very bulky.

Also called static layout, this type is followed in the manufacture, if bulky and heavy products, such as locomotives, ships, boilers, air crafts and generators.

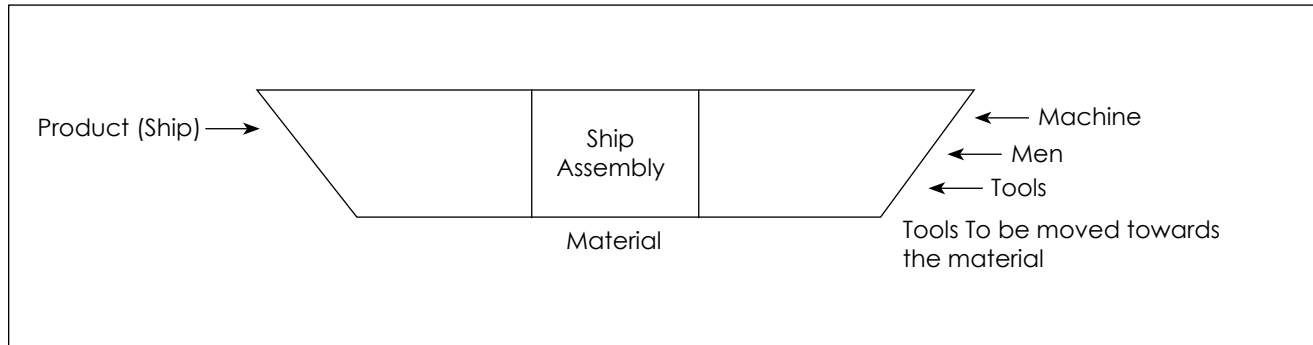

Mixed Layout or Combined Layout

The application of the principles of product layout or process layout in their strict meanings is difficult to come across. A combination of the product and process layouts, with an emphasis on either, is noticed in most industrial establishments. Plants are never laid out in either pure form. It is possible to have both types of layout in an efficiently combined form if the products manufactured are somewhat similar and not complex.

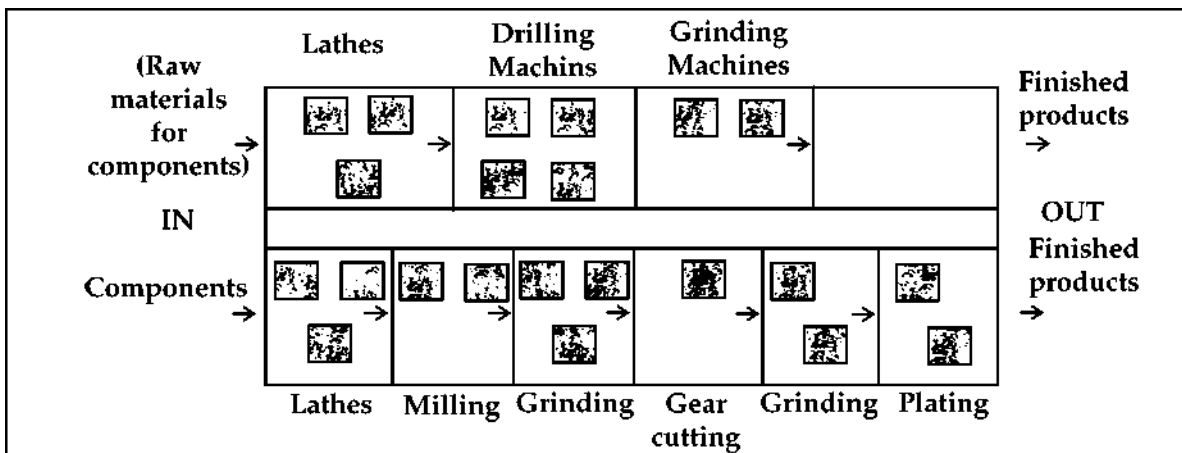

Component flow in combined layout

Layout of Service Facility:

The fundamental difference between service facility and manufacturing facility layouts is that many service facilities exist to bring together customers and services. Service facility layouts should provide for easy entrance to these facilities from freeways and busy thoroughfares. Large, well organized and amply lighted parking areas and well designed walkways to and from parking areas are some of the requirements of service facility layouts.

Because of different degree of customer contact, two types of service facility layouts emerge, viz., those that are almost totally designed around the customer receiving and servicing function (such as banks) and those that are designed around the technologies, processing of physical materials and production efficiency (such as hospitals).



Other facilities with reference to Plant Layout:

A plant layout involves, besides the grouping of machinery, an arrangement for other facilities as well. Such facilities include receiving and shipping points, inspection facilities, employee facilities and storage. Not all the facilities are required in every plant. The requirements depend on the nature of the product which is manufactured in a particular plant.

Importance of layout:

The importance of a layout can be described as under:

- **Avoidance of Bottlenecks:** Bottlenecks refer to any, place in a production process where materials tend to pile up or produced at rates of speed less rapid than the previous or subsequent operations. Bottlenecks are caused by inadequate machine capacity, inadequate storage space or low speed on the part of the operators. The results of bottlenecks are delays in production schedules, congestion, accidents and wastage of floor area. All these may be overcome with an efficient layout.
- **Avoidance of Unnecessary and Costly Changes:** A planned layout avoids frequent changes which are difficult and costly. The incorporation of flexibility elements in the layout would help in the avoidance of revisions.
- **Better Production Control:** Production control is concerned with the production of a product of the right type at the right time and at reasonable cost. A good plant layout is a requisite of good production control and provides the plant control officers with a systematic basis upon which to build organisation and procedures.
- **Better Supervision:** A good plant layout ensures better supervision in two ways: (a) Determining the number of workers to be handled by a supervisor and (b) Enabling the supervisor to get a full view of the entire plant at one glance. A good plant layout is, therefore, the first step in good supervision.
- **Economies in Handling:** Nearly 30 per cent to 40 per cent of the manufacturing costs are accounted for by materials handling. Every effort should, therefore, be made to cut down this cost. Long distance movements should be avoided and specific handling operations must be eliminated.
- **Effective Use of Available Area:** Every unit of the plant area is valuable, especially in urban areas. Efforts should therefore, be made to make use of the available area by planning the layout properly.
- **Improved Employee Morale:** Employee morale is achieved when workers are cheerful and confident. This state of mental condition is vital to the success of any organisation. Morale depends on better working conditions; better employee facilities; reduced number of accidents; and increased earnings.
- **Improved Quality Control:** Timely execution of orders will be meaningful when the quality of the output is not below expectations. To ensure quality, inspection should be conducted at different stages of manufacture. An ideal layout provides ample space to carryout inspection to ensure better quality control.
- **Improved Utilisation of Labour:** A good plant layout is one of the factors in effective utilisation of labour. It makes possible individual operations, the process and flow of materials handling in such a way that the time of each worker is effectively spent on productive operations.
- **Minimisation of Production Delays:** Repeat order and new customers will be the result of prompt execution of orders. Every management should try to keep to the delivery schedules by minimising delays in production.
- **Minimum Equipment Investment:** Investment on equipment can be minimised by planned machine balance and location, minimum handling distances, by the installation of general purpose machines and by planned machine loading. A good plant layout provides all these advantages.

Illustration 9.

The present layout is shown in the figure. The manager of the department is intending to interchange the departments C and F in the present layout. The handling frequencies between the departments is given. All the departments are of the same size and configuration. The material handling cost per unit length travel between departments is same. What will be the effect of interchange of departments C and F in the layout?

A	C	E
B	D	F



From / To	A	B	C	D	E	F
A	–	0	90	160	50	0
B	–	–	70	0	100	130
C	–	–	–	20	0	0
D	–	–	–	–	180	10
E	–	–	–	–	–	40
F	–	–	–	–	–	–

Solution:

The distance matrix of the present layout :

From / To	A	B	C	D	E	F
A		1	1	2	2	3
B			2	1	3	2
C				1	1	2
D					2	1
E						1
F						–

- (ii) Computation of total cost matrix (combining the inter departmental material handling frequencies and distance matrix.

From / To	A	B	C	D	E	F	Total
A		0	90	320	100	0	510
B			140	0	300	260	700
C				20	0	0	20
D					360	10	370
E						40	40
F							–
Total							1,640

If the departments are interchanged, the layout will be represented as shown below.

A	F	E
B	D	C

The distance matrix and the cost matrix are represented as shown.

From / To	A	B	C	D	E	F
A		1	3	2	2	1
B			2	1	3	2
C				1	1	2
D					2	1
E						1
F						



Total cost matrix for the modified layout.

From / To	A	B	C	D	E	F	Total
A	–	0	270	320	100	0	690
B			140	0	300	260	700
C				20	0	0	20
D					360	10	370
E						40	40
F							–
Total							1,820

The interchange of departments C and F increases the total material handling cost. Thus, it is not a desirable modification.

Illustration 10.

A defence contractor is evaluating its machine shops current process layout. The figure below shows the current layout and the table shows the trip matrix for the facility. Health and safety regulations require departments E and F to remain at their current positions.

E	B	F
A	C	D

Current Layout

From / To	A	B	C	D	E	F
A		8	3		9	5
B		-		3		
C			-		8	9
D				-		3
E					-	3
F						-

Can layout be improved? Also evaluate using load distance (ld) score.

Solution:

Keep the departments E and F at the current locations. From the Trip Matrix, C is having maximum no. of trips from E&F. So C must be as close as possible to both E and F, put C between them. Place A directly south of E, and B next to A. All of the heavy traffic concerns have been accommodated. Department D is located in the remaining place. The proposed layout is shown in figure below. The load distance (ld) scores for the existing and proposed layout are shown below. As ld score for proposed layout is less, the proposed layout indicates improvement over existing.

E	C	F
A	B	D

Comparative Analysis : Current and Proposed Layout :-

Dept. Pair	No. of Trips (1)	Existing plan		Proposed plan	
		Distance (2)	Load × Distance (1 × 2)	Distance (3)	Load × Distance (1 × 3)
A–B	8	2	16	1	8
A–C	3	1	3	2	6
A–E	9	1	9	1	9
A–F	5	3	15	3	15
B–D	3	2	6	1	3
C–E	8	2	16	1	8
C–F	9	2	18	1	9
D–F	3	1	3	1	3
E–F	3	2	6	2	6
Total			92		67

As 'ld' score of the proposed layout is lower than the existing one, there is an improvement in the new layout.



2.6 RESOURCES AGGREGATE PLANNING

Aggregate Planning:

Aggregate planning is an intermediate term planning decision. It is the process of planning the quantity and timing of output over the intermediate time horizon (3 months to one year). Within this range, the physical facilities are assumed to be fixed for the planning period. Therefore, fluctuations in demand must be met by varying labour and inventory schedule. Aggregate planning seeks the best combination to minimise costs.

Production planning in the intermediate range of time is termed as 'Aggregate Planning'. It is thus called because the demand on facilities and available capacities is specified in aggregate quantities. For example aggregate quantities of number of Automobile vehicles, Aggregate number of soaps etc. Here the total expected demand is specified without regard to the product mix that makes up the specified figure.

While dealing with production problems, the planning process is normally divided in three categories.

- (i) Long range Planning which deals with strategic decisions such as purchase of facilities, introduction of new products, processes etc.
- (ii) Short term planning which deals with day-to-day work, scheduling and sometimes inventory problems.
- (iii) Intermediate Planning or Aggregate Planning, which is in between long range and short term planning, which is concerned in generally acceptable planning taking the load on hand and the facilities available into considerations. In aggregate planning the management formulates a general strategy by which capacity can be made to satisfy demand in a most economical way during a specific moderate time period, say for one year. The aggregate planning is made operational through a master schedule that gives the manufacturing schedule (Products and dates of manufacture). Generally, day-to-day schedules are prepared from master schedule. Facility planning and scheduling has got very close relationship with aggregate planning.

Aggregate Planning Strategies:

The variables of the production system are labour, materials and capital. More labour effort is required to generate higher volume of output. Hence, the employment and use of overtime (OT) are the two relevant variables. Materials help to regulate output. The alternatives available to the company are inventories, back ordering or subcontracting of items.

These controllable variables constitute pure strategies by which fluctuations in demand and uncertainties in production activities can be accommodated.

Vary the size of the workforce: Output is controlled by hiring or laying off workers in proportion to the changes in demand.

Vary the hours worked: Maintain the stable workforce, but permit idle time when there is a 'slack' and permit overtime (OT) when demand is 'peak'.

Vary inventory levels: Demand fluctuations particularly increase in demand can be met by large amount of inventory.

Subcontract: In case of upward shift in demand from low level. Required production rates can be met by using the capacities available with the external vendors. This is also known as subcontracting.

Aggregate planning guidelines:

1. Determine corporate policy regarding controllable variables.
2. Use a good forecast as a basis for planning.
3. Plan in proper units of capacity.
4. Maintain the stable workforce.
5. Maintain needed control over inventories.
6. Maintain flexibility to change.
7. Respond to demand in a controlled manner.
8. Evaluate planning on a regular basis.

**Properties of Aggregate Planning:**

To facilitate the production manager the aggregate planning must have the following characteristics:

- (i) Both out put and sales should be expressed in a logical overall unit of measuring. For example, an automobile manufacturing company can say 1000 vehicles per year, without giving the number of each variety of vehicle. Similarly a paint industry can say 10,000 litres of paint and does not mention the quantities of each variety of colour.
- (ii) Acceptable forecast for some reasonable planning period, say one year.
- (iii) A method of identification and fixing the relevant costs associated with the plant. Availability of alternatives for meeting the objective of the organization.

Ability to construct a model that will permit to take optimal or near optimal decisions for the sequence of planning periods in the planning horizon.

- (iv) Facilities that are considered fixed to carry out the objective.

Illustration 11.

ABC. Co. has developed a forecast for the group of items that has the following demand pattern

Quarter	Demand	Cumulative demand
1	270	270
2	220	490
3	470	960
4	670	1630
5	450	2080
6	270	2350
7	200	2550
8	370	2920

The firm estimates that it costs ₹ 150 per unit to increase production rate ₹ 200 per unit to decrease the production rate, ₹ 50 per unit per quarter to carry the items in inventory and ₹100 per unit if subcontracted. Compare the costs of the pure strategies.

Solution:**Different pure strategies are**

Plan I In this pure strategy, the actual demand is met by varying the work force size. This means that during the period of low demand, the company must fire the workers and during the period of high demand the company must hire workers. These two steps involve associated costs. In this strategy, the production units will be equal to the demand and values in each period. The cost of the plan is computed in the table below,

Quarter	Demand	Cost of increasing Production level (₹)	Cost of decreasing Production level (₹)	Total cost of plan (₹)
1	270	—	—	—
2	220	—	50 x 200 = 10,000	10,000
3	470	250 x 150 = 37,500	—	37,500
4	670	200 x 150 = 30,000	—	30,000
5	450	—	220 x 200 = 44,000	44,000
6	270	—	180 x 200 = 36,000	36,000
7	200	—	70 x 200 = 14,000	14,000
8	370	170 x 150 = 25,500	—	25,500
	Total			1,97,000

Plan II In this plan, the company computes the average demand and sets its production capacity to this average demand. This results in excess of units in some periods and also shortage of units during some other periods. The excess units will be carried as inventory for future use and shortage of units can be fulfilled using future inventory. The cost of the plan II is computed in the table below. The plan incurs a maximum shortage of 255 units during quarter 5. The firm might decide to carry 255 units from the beginning of period 1 to avoid shortage. The total cost of the plan is ₹ 96,500.

Quarter	Demand forecast	Cumulative demand	Production level = Av. demand = $2920 \div 8$	Cumu. prod. level	Inventory = (Cum. Production - Cum. Demand)	Adjusted inventory with 255 at beginning of period 1	Cost of holding inventory (₹)
1	270	270	365	365	95	350	17,500
2	220	490	365	730	240	495	24,750
3	470	960	365	1095	135	390	19,500
4	670	1630	365	1460	-170	85	4,250
5	450	2080	365	1825	-255	0	0
6	270	2350	365	2190	-160	95	4,750
7	200	2550	365	2555	5	260	13,000
8	370	2920	365	2920	0	255	12,750
	Total						96,500

Plan III

Normal Production Capacity is assumed to be 200 units i.e. Minimum of the demand values. The additional demand other than the normal capacity is met by subcontracting. The cost of the plan III amounts to ₹ 1,32,000 as shown in table below.

Quarter	Demand forecast	Production units	Subcontract units	Incremental cost @ ₹ 100/units
1	270	200	70	$70 \times 100 = 7,000$
2	220	200	20	$20 \times 100 = 2,000$
3	470	200	270	$270 \times 100 = 27,000$
4	670	200	470	$470 \times 100 = 47,000$
5	450	200	250	$250 \times 100 = 25,000$
6	270	200	70	$70 \times 100 = 7,000$
7	200	200	0	0
8	370	200	170	$170 \times 100 = 17,000$
			Total	= 1,32,000

The total cost of pure strategies is given below. On observation Plan II (Changing inventory levels) has the least cost.

Plan	Total cost (₹)
Plan I	1,97,000
Plan II	96,500
Plan III	1,32,000



2.7 MATERIAL REQUIREMENTS PLANNING

Material requirement planning (MRP) refers to the basic calculations used to determine component requirements from end item requirements. It also refers to a broader information system that uses the dependence relationship to plan and control manufacturing operations.

MRP is a technique of working backward from the scheduled quantities and needs dates for end items specified in a master production schedule to determine the requirements for components needed to meet the master production schedule. The technique determines what components are needed, how many are needed, when they are needed and when they should be ordered so that they are likely to be available as needed. The MRP logic serves as the key component in an information system for planning and controlling production operations and purchasing. The information provided by MRP is highly useful in scheduling because it indicates the relative priorities of shop orders and purchase orders.

"Materials Requirement Planning (MRP) is a technique for determining the quantity and timing for the acquisition of dependent demand items needed to satisfy master production schedule requirements."

MRP is one of the powerful tools that, when applied properly, helps the managers in achieving effective manufacturing control.

MRP Objectives:

1. **Inventory reduction:** MRP determines how many components are required, when they are required in order to meet the master schedule. It helps to procure the materials/components as and when needed and thus avoid excessive build up of inventory.
2. **Reduction in the manufacturing and delivery lead times:** MRP identifies materials and component quantities, timings when they are needed, availabilities and procurements and actions required to meet delivery deadlines. MRP helps to avoid delays in production and priorities production activities by putting due dates on customer job orders.
3. **Realistic delivery commitments:** By using MRP, production can give marketing timely information about likely delivery times to prospective customers.
4. **Increased efficiency:** MRP provides a close coordination among various work centres and hence helps to achieve uninterrupted flow of materials through the production line. This increases the efficiency of production system.

Functions served by MRP

1. **Order planning and control:** When to release orders and for what quantities of materials.
2. **Priority planning and control:** How the expected date of availability is compared to the need date for each component.
3. Provision of a basis for planning capacity requirements and developing a broad business plans.

Advantages and Disadvantages of MRP

Advantages :

- (i) Reduced inventory,
- (ii) Reduced idle time,
- (iii) Reduced set up time,
- (iv) Ability to change the master production schedule,
- (v) Ability to price more competitively,
- (vi) Better customer service,



- (vii) Better response to market demands,
- (viii) Reduced sales price.

In addition the MRP system enables the following:

- (i) Aids capacity planning,
- (ii) Helps managers to use the planned schedule before actual release orders,
- (iii) Tells when to expedite or deexpedite,
- (iv) Delays or cancels orders,
- (v) Changes order quantities,
- (vi) Advances or delays order due dates.

Disadvantages :

Even though MRP system has many advantages, there are some problems with MRP systems which make them fail in many firms. Three major causes for failures of an MRP system are:

- (i) Lack of top management commitment. MRP must be accepted by top management as a planning tool with specific reference to profit results. All executives concerned with the implementation of the MRP system must be educated emphasizing the importance of MRP as a closed-loop, integrated strategic planning tool.
- (ii) MRP was presented and perceived as a complete and stand-alone system to run a firm, rather than as part of the total system.
- (iii) The issue of how MRP can be made to function with just-in-time production system.

MRP also needs a high degree of accuracy for operation, which often requires (i) changing how the firm operates and (ii) updating files.

The major complaint by users of MRP is that MRP is too rigid because when MRP develops a schedule, it is quite difficult to deviate from the schedule if need arises.

2.8 MANUFACTURING RESOURCES PLANNING

Manufacturing Resource Planning (MRP II) has been developed to facilitate manufacturing managers address the planning and controlling of a manufacturing process and all of its related support functions. It encompasses logically correct planning and control activities related to materials, capacity, finance, engineering, sales and marketing. MRP II is universally applicable to any manufacturing organization regardless of its size, location, product or process.

MRP II is a management process for taking the business plan and breaking it down into specific, detailed tasks that people evaluate, agree upon and are held accountable for. It involves all departments viz., materials department, engineering department that must maintain bill of materials, sales/marketing department that must keep sales plan upto date, purchasing and manufacturing departments that must meet due dates for bought out items and in-house manufactured items respectively.

From MRP I to MRP II : Manufacturing resource planning (MRP II) is a natural outgrowth of Materials Requirement Planning (MRP I) Whereas MRP I focuses upon priorities of materials, CRP is concerned with time. Both material and time requirement are integrated within the MRP system [i.e., MRP I]. Beyond this, MRP II has been coined to 'close the loop' by integrating financial, accounting, personnel, engineering and marketing information along with the production planning and control activities of basic MRP systems. MRP II is the heart of corporate management information system for many manufacturing firms.



Evolution of MRP II

The earlier resource requirement planning systems were quite simple and unsophisticated. The MRP technique was used for its most limited capability to determine what materials and components are needed, how many are needed and when they are needed and when they should be ordered so that they are likely to be available when needed. In other words, MRP simply exploded the MPS into the required materials and was conceived as an inventory control tool or a requirements calculator. Later the logic of MRP technique was extended to serve as the key component in an information system for planning and controlling production operation and purchasing. It was helpful to production and operations managers to determine the relative priorities of shop orders and purchase orders. As a manufacturing planning and control system, MRP laid the basic foundation for production activity control or shop-floor control.

2.9 ENTERPRISE RESOURCES PLANNING

Enterprise resource planning, popularly known as ERP, is today's buzz-word in the corporate world. Companies world-wide use ERP to integrate business processes and thereby reduce costs and increase productivity. It has established its base as a global phenomena.

Traditionally, companies developed isolated computer applications to suit and satisfy each of their functional segments such as sales, purchase, production, inventory, personnel and accounts. Materials Requirement Planning (MRP I) and Manufacturing Resource Planning re (MRP II) were developed basically to address the requirements of the manufacturing set-up. But the information available in various functional segments was so scattered that it was almost impossible to consolidate the information and provide the same to the people in the top management to enable them to take vital business decisions. Hence, the companies, whether in the manufacturing or the service sector have been searching for the 'total solution' on an integrated system which could provide for the information needs of the entire enterprise. ERP software was developed to provide such a 'total solution' to the business enterprise.

To be highly successful in today's global competitive market, it is necessary that business enterprises continuously strive for developing a high level of interaction and co-ordination along the supply chain and improve in the area of quality, time to reach the market, customer satisfaction, performance and profitability. The ERP software fulfils this need.

What is ERP?

ERP is a business process management software package developed for optimum use of resources of an enterprise in a planned manner. ERP integrates the entire enterprise starting from the supplier to the customer, covering logistics, financial and human resources. This will enable the enterprise to increase productivity by reducing costs. ERP is a package for cost saving. Once the ERP is Implemented, a single solution addresses the information needs of the whole organisation.

2.10 ECONOMIC BATCH QUANTITY

Production managers often have to decide what quantity of output must be produced in a batch (known as lot size or batch size). The products are manufactured in lot sizes against the anticipated demand for the products. Often the quantity produced may exceed the quantity which can be sold. (i.e., production rates exceed demand rates). The optimum lot size which is known as economic lot size or Economic Order Quantity or economic batch quantity or economic manufacturing quantity is that quantity of output produced in one batch, which is most economical to produce, i.e., which results in lowest average cost of production.

Determination of Economic Lot Size for Manufacturing:

The factors to be considered in arriving at the economic lot size are:

- (i) **Usage rate:** The rate of production of parts should match with the rate of usage of these parts in the assembly line.
- (ii) **Manufacturing cost:** Higher the lot size, lower will be the cost per unit produced because of distribution of set up costs for setting up production or machines and preparing paper work (production orders). But the carrying cost (handling and storing costs) will increase with increase in lot size.
- (iii) **Cost of deterioration and obsolescence:** Higher the lot size, higher will be the possibility of loss due to deterioration (items deteriorating after shelf life) or obsolescence (due to change in technology or change in product design).

Before deciding on production using economic lot sizes, the availability of production capacity to produce the product in economic lot size must be verified. The economic lot size balances the two opposing costs related to batch size i.e., setup cost for production and the inventory carrying costs resulting from inventory of products produced when production rate exceeds usage rate or when the items produced are not immediately consumed in the next stage of production. The set up cost per unit decreases with increase in lot size whereas the inventory carrying cost increases with increase in lot size. Diagram below illustrates the concept of economic batch quantity or economic lot size or Economic Order Quantity.

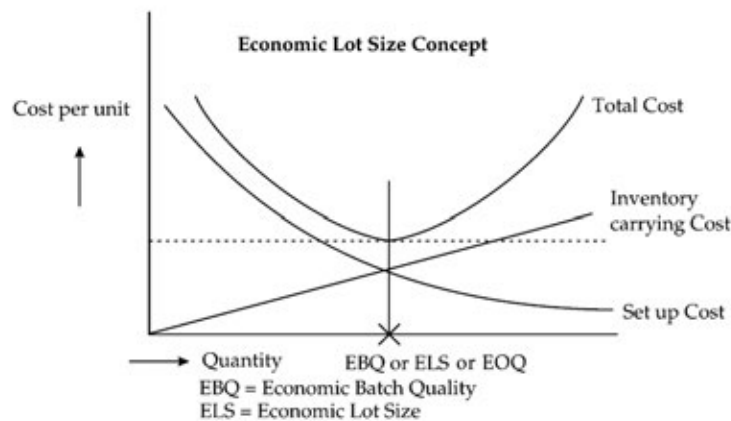

If S is the set up cost per set up also known as Ordering Cost, 'C' is the production cost per unit produced and I is the inventory carrying or holding charges (%) and A is the annual demand for the item in units, then,

Economic Batch Quantity (EBQ) or Economic Order Quantity (EOQ)

or Economic Lot Size (ELS)

or Economic Manufacturing Quantity (EMQ)

$$= \sqrt{\frac{2AS}{C}} = \sqrt{\frac{2 \times \left(\frac{\text{Annual demand}}{\text{in units}}\right) \times \left(\frac{\text{Set up Cost}}{\text{per set up}}\right)}{\left(\frac{\text{Production Cost}}{\text{per unit}}\right) \times \left(\frac{\text{Inventory carrying}}{\text{charges (percentage)}}\right)}$$

Economic Run Length: When a firm is producing an item and keeping it in inventory for later use, instead of buying it, the formula used to calculate economic order quantity (EOQ) can be used to calculate the economic production quantity referred to as Economic Run Length (ERL).

If 'p' is the production rate and 'd' is the demand rate (or consumption rate), A is the annual demand for the item in units, I is the inventory carrying charges (percentage), C is the production cost per unit, then,



$$\begin{aligned} \text{Economic Run Length (ERL)} &= \sqrt{\frac{2AS}{CI\left(1-\frac{d}{p}\right)}} \\ &= \sqrt{\frac{2 \times (\text{Annual Demand (in units)}) \times (\text{Set up Cost per set up})}{(\text{Production Cost per unit}) \times (\text{Inventory Carrying charges (Percentage)}) \left(1 - \frac{\text{Demand Rate}}{\text{Production Rate}}\right)}} \end{aligned}$$

Illustration 12.

The monthly requirement of raw material for a company is 3000 units. The carrying cost is estimated to be 20% of the purchase price per unit, in addition to ₹ 2 per unit. The purchase price of raw material is ₹ 20 per unit. The ordering cost is ₹ 25 per order. (i) You are required to find EOQ. (ii) What is the total cost when the company gets a concession of 5% on the purchase price if it orders 3000 units or more but less than 6000 units per month. (iii) What happens when the company gets a concession of 10% on the purchase price when it orders 6,000 units or more? (iv) Which of the above three ways of orders the company should adopt?

Solution:

We are given that,

A = Annual demand = 3,000 × 12 = 36,000 units per annum ; S = Ordering Cost = ₹ 25;

C = Inventory carrying cost = 2 + 20% of ₹ 20 = 2 + 4 = ₹ 6

$$(i) \quad \text{EOQ} = \sqrt{\frac{2AS}{C}} = \sqrt{\frac{2 \times 36000 \times 25}{6}} = \sqrt{3,00,000} = 548 \text{ units (approx.)}$$

Total cost = Ordering Cost + Cost of purchasing the material + Storage cost

$$= (36,000 / 548) \times 25 + (36,000 \times 20) + (548/2) \times 6 \quad [\because \text{Storage cost} = \text{Average Inventory} \times \text{Inventory carrying cost}]$$

$$= ₹ 1642.33 + 7,20,000 + 1,644 = ₹ 7,23,286. \quad = \frac{\text{EOQ}}{2} \times 6]$$

(ii) When the company has an option to order between 3000 and 6000 units, the EOQ should be calculated with a reduction in price by 5% (due to concession); The purchase price = 95% of ₹ 20 = ₹ 19.

A = 36,000 units per annum; S = ₹ 25; C = 2 + 20% of 19 = 2 + 3.80 = ₹ 5.80

$$\text{EOQ} = \sqrt{\frac{2 \times 36000 \times 25}{5.80}} = \sqrt{\frac{18,00,000}{5.80}} = 557 \text{ units app.}$$

Total cost = (36,000/557) × 25 + (36,000 × 19) + (557/2) × 5.80

$$= ₹ (1,615.79 + 6,84,000 + 1,615.30) = ₹ 6,87,231.09$$

For monthly order quantity being 3000 units or more but less than 6000 units

EOQ = 557 units

$$\text{No. of orders per year} = \frac{\text{Yearly demand}}{\text{EOQ}} = \frac{36000}{557} = N \text{ (let)}$$

$$\text{No. of orders per month} = \frac{N}{12} = \frac{36000 / 557}{12} = 5.385 = 6 \text{ (say)} = N^*$$

Quantity to be orderd per month = N* × EOQ = 6 × 557 = 3342 units



This quantity lies in the range of 3000 to 6000 units

Hence the EOQ (557 units) can be considered to be a feasible quantity for availing 5% discount on Purchase Price.

- (iii) When the company orders more than 6,000 units purchase price = 90% of ₹ 20 (because 10% concession)
 = ₹ 18; A = 36,000 units per annum; S = ₹ 25; C = 2 + 20% of ₹ 18
 = 2 + 3.60 = 5.60

$$\text{EOQ} = \sqrt{\frac{2AS}{C}} = \sqrt{\frac{2 \times 36000 \times 25}{5.60}} = 567 \text{ units app.}$$

For monthly order quantity more than or equal to 6000 units

EOQ = 567 units

No of orders per month = $\frac{36000 / 567}{12} = 5.29 = 6$ (say) = N*

Qty. to be ordered per month = N* × EOQ = 6 × 567 = 3402 units

This quantity does not lie in the range of 6000 or more units.

Hence the EOQ (567 units) can not be considered as feasible quantity for availing 10% discount on Purchase Price.

To understand the effect of 10% on Total Cost, we consider the minimum value of price break quantity of this range i.e. 6000 units to be the optimum order quantity and calculate.

Total Cost as follows —

TC = Ordering Cost + Cost of Purchasing the material + Storage Cost

$$\begin{aligned} &= \frac{36000}{6000} \times 25 + 36000 \times 18 + \frac{6000}{2} \times 5.60 \\ &= 150 + 648000 + 16800 = ₹ 6,64,950 \end{aligned}$$

Hence the total cost will be minimum (₹ 6,64,950) if orders are placed in lot size of 6000 units.

Illustration 13.

M/s. Tubes Ltd. are the manufacturers of picture tubes of T.V. The following are the details of their operation during 2001:

Average monthly market demand	2,000 tubes
Ordering cost	₹ 100 per order
Inventory carrying cost	20% per annum
Cost of tubes	₹ 500 per tube
Normal usage	100 tubes per week
Minimum usage	50 tubes per week
Maximum usage	200 tubes per week
Lead time to supply	6 – 8 weeks

Compute from the above:



- (1) Economic order quantity. If the supplier is willing to supply quarterly 1,500 units at a discount of 5%, is it worth accepting?
- (2) Maximum level of stock.
- (3) Minimum level of stock.
- (4) Re-order level of stock.

Solution:

- (1) Economic Order Quantity:

$$\begin{aligned} \text{Annual usage of tubes (A)} &= \text{Normal usage per week} \times 52 \text{ weeks} \\ &= 100 \text{ tubes} \times 52 \text{ weeks} \\ &= 5,200 \text{ tubes.} \end{aligned}$$

$$\text{Ordering cost per order (S)} = ₹ 100.$$

$$\text{Inventory carrying cost per unit per annum (C)} = 20\% \text{ of } ₹ 500 = ₹ 100.$$

$$\text{EOQ} = \sqrt{\frac{2AS}{C}} = \sqrt{\frac{2 \times 200 \text{ units} \times ₹ 100}{₹ 100}} = 102 \text{ units (approx.).}$$

(A) Evaluation of order size of 1,500 units at 5% discount

$$\text{No. of orders} = \frac{5,200 \text{ units}}{1,500 \text{ units}} = 3.46 \text{ or } 4 \text{ (in case of a fraction, the next whole number is considered).}$$

	₹
Ordering cost (No. of order per year at ₹ 100 per order)	400
Carrying cost of average inventory:	
$\frac{1,500 \text{ units}}{2} \times ₹ (500 \text{ less } 5\%) \times \frac{20}{100}$	71,250
Total annual cost (excluding item cost)	71,650

(B) Annual cost if EOQ (102 units) is adopted :

	₹
Ordering cost: $5,200 \div 102$ or 51 orders per year at ₹100 per order	5,100
Carrying cost of average inventory $\frac{102 \text{ units}}{2} \times ₹ 500 \times \frac{20}{100}$	5,100
Total annual cost (excluding item cost)	10,200

Increase in annual cost by adopting (A) above : ₹ (71,650 – 10,200) = ₹ 61,450.

Amount of quantity discount: $5\% \times ₹ 500 \times 5,200 \text{ units} = ₹ 1,30,000$.

Since the amount of quantity discount (₹ 1,30,000) is more than the increase in total annual cost (₹ 61,450), it is advisable to accept the offer. This will result in a saving of ₹ (1,30,000 - 61,450) or ₹ 68,550 p.a. in inventory cost.

- (2) Maximum Level of Stock:

$$= \text{Re-order level} + \text{Re-order quantity} - (\text{Minimum usage} \times \text{Minimum delivery period}) = 1,600 \text{ units} + 102 \text{ units} - (50 \text{ units} \times 6 \text{ weeks}) = 1,402 \text{ units.}$$

[Assume that the Reorder quantity is supplied as soon as the Reorder level is reached]



(3) Minimum Level of Stock:

= Re-order level – (Normal usage × Normal delivery period) [see Note] = 1,600 units – (100 units × 7 weeks) = 900 units. Note: Normal delivery period is taken to be the average delivery period.

(4) Re-order Level of Stock:

= Maximum usage × Maximum delivery period = 200 units × 8 weeks = 1,600 units.

Illustration 14.

M/s Kobo Bearings Ltd., is committed to supply 24,000 bearings per annum to M/s Deluxe Fans on a steady daily basis. It is estimated that it costs 10 paisa as inventory holding cost per bearing per month and that the setup cost per run of bearing manufacture is ₹ 324.

(a) What is the optimum run size for bearing manufacture?

(b) What should be the interval between the consecutive optimum runs?

(c) Find out the minimum inventory holding cost.

Solution:

(a) Optimum run size or Economic Batch Quantity (EBQ)

$$= \sqrt{\frac{2 \times \text{Annual Output} \times \text{Setup cost}}{\text{Annual Cost of Carrying one unit}}} = \sqrt{\frac{2 \times 24000 \times 324}{0.10 \times 12}} = 3600 \text{ units}$$

(b) Interval between two consecutive optimum runs = $\frac{\text{EBQ}}{\text{Monthly Output}} \times 30$

$$= \frac{3600}{24000 \div 12} \times 30 = 54 \text{ Calendar days}$$

(c) Minimum inventory holding cost = Average inventory × Annual carry-ing cost of one unit of inventory

$$= (3600 \div 2) \times 0.10 \times 12 = ₹ 2,160.$$

Illustration 15.

A company planning to manufacture a household cooking range has to decide on the location of the plant. Three locations are being considered viz., Patna, Ranchi, and Dhanbad. The fixed costs of the three location are estimated to be ₹30 lakh, ₹50 lakh, and ₹25 lakh per annum respectively. The variable costs are ₹300, ₹200 and ₹350 per unit respectively.

The expected sales price of the cooking range is ₹700 per unit Find out:

(i) The range of annual production/sales volume for which each location is most suitable and

(ii) Which one of the three locations is the best location at a production/sales volume of 18,000 units?

Answer:

The total cost of the three locations are:

At Total cost = Fixed cost + Variable cost for a volume "X"

Patna => Total cost = 30,00,000 + 300 × X

Ranchi => Total cost = 50,00,000 + 200 × X

Dhanbad => Total cost = 25,00,000 + 350 × X

We can compute and plot the total costs per annum at the three different locations for the various cases of production volume of 5,000, 10,000, 15,000, 20,000 25,000 units.

**(i) Patna**

Volume (x Units)	5,000	10,000	15,000	20,000	25,000
Fixed Cost (₹)	30,00,000	30,00,000	30,00,000	30,00,000	30,00,000
Variable Cost (₹ 300 x)	300 (5,000)	300 (10,000)	300 (15,000)	300 (20,000)	300 (25,000)
Total Cost (₹)*	= ₹45 lakhs	= ₹60 lakhs	= ₹75 lakhs	= ₹90 lakhs	= ₹105 lakhs

(ii) Ranchi

Volume (x Units)	5,000	10,000	15,000	20,000	25,000
Fixed Cost (₹)	50,00,000	50,00,000	50,00,000	50,00,000	50,00,000
Variable Cost (₹ 200 x)	200 (5,000)	200 (10,000)	200 (15,000)	200 (20,000)	200 (25,000)
Total Cost (₹)*	= ₹60 lakhs	= ₹70 lakhs	= ₹80 lakhs	= ₹90 lakhs	= ₹100 lakhs

(iii) Dhanbad

Volume (x Units)	5,000	10,000	15,000	20,000	25,000
Fixed Cost (₹)	25,00,000	25,00,000	25,00,000	25,00,000	25,00,000
Variable Cost (₹ 300x)	350 (5,000)	350 (10,000)	350 (15,000)	350 (20,000)	350 (25,000)
Total Cost (₹)*	= ₹42.5 lakhs	= ₹60 lakhs	= ₹77.5 lakhs	= ₹95 lakhs	= ₹112.5 lakhs

* In all the above tables, Total Cost = Fixed Cost + Variable Cost

If the volume distribution be as follows:

	Up to 10,000 units	Between 10,000 units to 20,000 units	Above 20,000 units
Favourable Location	Dhanbad	Patna	Ranchi

For a volume of 18000 units favourable location is Patna which can be substantiated by the followings calculations of Total Cost:-

Patna => 30,00,000 + 300 × 18,000 = ₹84 lakhs

Ranchi => 50,00,000 + 200 × 18,000 = ₹86 lakhs

Dhanbad => 25,00,000 + 350 × 18,000 = ₹88 lakhs.

Illustration 16.

Monthly demand for a component is 1000 units. Setting-up cost per batch is ₹ 120. Cost of manufacture per unit is ₹ 20. Rate of interest may be considered at 10% p.a. Calculate the EBQ.

Answer:

Calculation of EBQ:

$$\begin{aligned} \text{EBQ} &= \sqrt{\frac{2 \times \text{Annual Demand} \times \text{Set-up cost}}{\text{Unit Cost} \times \text{Inventory carrying cost per unit per year (₹)}}} \\ &= \sqrt{\frac{(2 \times 12 \times 1000 \times 120)}{(0.1 \times 20)}} = 1200 \text{ units.} \end{aligned}$$

Illustration 17.

Based on the following data on the exports of an item by a company during the various years fit a straight line, (for the time being, assume that a straight line gives a good fit). Give a forecast for the years 2013 and 2014.

Year	No. of items ('000)
2004	13
2005	20
2006	20
2007	28
2008	30
2009	32
2010	33
2011	38
2012	43

Answer:

We can call the years as 'X' and exports as 'Y'. In order to use the normal equations for the least square line, we need ΣX , ΣY , ΣXY and ΣX^2 . If we arrange X in such a way that $\Sigma X = 0$, it will simplify our calculations. Therefore, we call the year 2008 as 0, 2007 as -1 and 2009 as +1 and likewise for the other years in the data.

The rearrangement is shown in the table as follows:

X	Y	X ²	XY
-4	13	16	-52
-3	20	9	-60
-2	20	4	-40
-1	28	1	-28
0	30	0	0
1	32	1	32
2	33	4	66
3	38	9	114
4	43	16	172
$\Sigma X = 0$	$\Sigma Y = 257$	$\Sigma X^2 = 60$	$\Sigma XY = 204$



Let the equation of the best fit straight line to the given data be $Y = a_0 + a_1x$

So the normal equations are

$$\Sigma Y = a_0N + a_1\Sigma X \quad \dots\dots\dots (1)$$

$$\Sigma XY = a_0\Sigma X + a_1\Sigma X^2 \quad \dots\dots\dots (2)$$

As $\Sigma X = 0$, from (1) $\Sigma Y = a_0N$ from (2) $\Sigma XY = a_1\Sigma X^2$

$$\text{Therefore, } a_0 = \Sigma Y / N = 257 / 9 = 28.56 \quad [N = \text{No. of years}]$$

$$a_1 = \Sigma XY / \Sigma X^2 = 204 / 60 = 3.4$$

The equation of a straight line fitting the data is:

$$Y = 28.56 + 3.4 X$$

(a) Forecast for 2013, (i.e., $X = 5$): $Y = 28.56 + 3.4 (5) = 45.56$ ('000) nos.

(b) Forecast for 2014, (i.e., $X = 6$): $Y = 28.56 + 3.4 (6) = 48.96$ ('000) nos.

Study Note - 3

DESIGNING OF OPERATIONAL SYSTEM AND CONTROL



This Study Note includes

- 3.1 Product Design
- 3.2 Process Design & Selection
- 3.3 Process Planning
- 3.4 Product Life Cycle
- 3.5 Process Selection

3.1 PRODUCT DESIGN

Importance of Product Design

Production or operations strategy is directly influenced by product design for the following reasons:

- (i) As products are designed, all the detailed characteristics of each product are established.
- (ii) Each product characteristic directly affects how the product can be made or produced (i.e., process technology and process design) and
- (iii) How the product is made determines the design of the production system (production design) which is the heart of production and operations strategy.

Further, product design directly affects product quality, production costs and customer satisfaction. Hence, the design of product is crucial to success in today's global competition.

A good product design can improve the marketability of a product by making it easier to operate or use, upgrading its quality, improving its appearance, and/or reducing manufacturing costs.

A distinctive design may be the only feature that significantly differentiates a product. An excellent design includes usability, aesthetics, reliability, functionality, innovation and appropriateness. An **excellent design** provides competitive advantage to the manufacturer, by ensuring appropriate quality, reasonable cost and the expected product features. Firms of tomorrow will definitely compete not on price and quality, but on product design.

What Does Product Design Do?

The activities and responsibilities of product design include the following:

- (i) Translating customer needs and wants into product and service requirements (marketing).
- (ii) Refining existing products (marketing).
- (iii) Developing new products (marketing, product design and production).
- (iv) Formulating quality goals (quality assurance, production).
- (v) Formulating cost targets (accounting).
- (vi) Constructing and testing prototype (marketing, production).
- (vii) Documenting specifications (product design).

Reasons for Product Design or Redesign

The most obvious reason for product design is to offer new products to remain competitive in the market. The second most important reason is to make the business grow and increase profits. Also, when productivity gains result in reduction of workforce, developing new products can mean adding jobs and retaining surplus workforce instead of downsizing by layoffs/ retrenchment.



Sometimes product design is actually redesign or modification of existing design instead of an entirely new design. The reasons for this include customer complaints, accidents or injuries during product use, excessive warranty claims or low demand. Sometimes product redesign is initiated to achieve cost reductions in labour and material costs.

Objectives of Product Design

- (i) The overall objective is profit generation in the long run.
- (ii) To achieve the desired product quality.
- (iii) To reduce the development time and cost to the minimum.
- (iv) To reduce the cost of the product.
- (v) To ensure producibility or manufacturability (design for manufacturing and assembly).

Factors Influencing Product Design

- (i) **Customer requirements:** The designers must find out the exact requirements of the customers to ensure that the products suit the convenience of customers for use. The products must be designed to be used in all kinds of conditions.
- (ii) **Convenience of the operator or user:** The industrial products such as machines and tools should be so designed that they are convenient and comfortable to operate or use.
- (iii) **Trade off between function and form:** The design should combine both performance and aesthetics or appearance with a proper balance between the two.
- (iv) **Types of materials used:** Discovery of new and better materials can improve the product design. Designers keep in touch with the latest developments taking place in the field of materials and components and make use of improved materials and components in their product designs.
- (v) **Work methods and equipments:** Designers must keep abreast of improvements in work methods, processes and equipments and design the products to make use of the latest technology and manufacturing processes to achieve reduction in costs.
- (vi) **Cost/Price ratio:** In a competitive market, there is lot of pressure on designers to design products which are cost effective because cost and quality are inbuilt in the design. With a constraint on the upper limit on cost of producing products, the designer must ensure cost effective designs.
- (vii) **Product quality:** The product quality partly depends on quality of design and partly on quality of conformance. The quality policy of the firm provides the necessary guidelines for the designers regarding the extent to which quality should be built in the design stage itself by deciding the appropriate design specifications and tolerances.
- (viii) **Process capability:** The product design should take into consideration the quality of conformance, i.e., the degree to which quality of design is achieved in manufacturing. This depends on the process capability of the machines and equipments. However, the designer should have the knowledge of the capability of the manufacturing facilities and specify tolerances which can be achieved by the available machines and equipments.
- (ix) **Effect on existing products:** New product designs while replacing existing product designs, must take into consideration the use of standard parts and components, existing manufacturing and distribution strategies and blending of new manufacturing technology with the existing one so that the costs of implementing the changes are kept to, the minimum.
- (x) **Packaging:** Packaging is an essential part of a product and packaging design and product design go hand in hand with equal importance. Packaging design must take into account the objectives of packaging such as protection and promotion of the product. Attractive packaging enhances the sales appeal of products in case of consumer products (nondurable).



Characteristics of Good Product Design

A good product design must ensure the following:

- (i) **Function or performance:** The function or performance is what the customer expects the product to do to solve his/her problem or offer certain benefits leading to satisfaction. For example, a customer for a motor bike expects the bike to start with a few kicks on the kick peddle and also expects some other functional aspects such as pick-up, maximum speed, engine power and fuel consumption etc.
- (ii) **Appearance or aesthetics:** This includes the style, colour, look, feel, etc. which appeals to the human sense and adds value to the product.
- (iii) **Reliability:** This refers to the length of time a product can be used before it fails. In other words, reliability is the probability that a product will function for a specific time period without failure.
- (iv) **Maintainability:** Refers to the restoration of a product once it has failed. High degree of maintainability is desired so that the product can be restored (repaired) to be used within a short time after it breaks down. This is also known as serviceability.
- (v) **Availability:** This refers to the continuity of service to the customer. A product is available for use when it is in an operational state. Availability is a combination of reliability and maintainability. High reliability and maintainability ensures high availability.
- (vi) **Productibility:** This refers to the ease of manufacture with minimum cost (economic production). This is ensured in product design by proper specification of tolerances, use of materials that can be easily processed and also use of economical processes and equipments to produce the product quickly and at a cheaper cost.
- (vii) **Simplification:** This refers to the elimination of the complex features so that the intended function is performed with reduced costs, higher quality or more customer satisfaction. A simplified design has fewer parts which can be manufactured and assembled with less time and cost. "
- (viii) **Standardisation:** Refers to the design activity that reduces variety among a group of products or parts. For example, group technology items have standardised design which calls for similar manufacturing process steps to be followed. Standard designs lead to variety reduction and results in economies of scale due to high volume of production of standard products. However, standardised designs may lead to reduced choices for customers.
- (ix) **Specification:** A specification is a detailed description of a material, part or product, including physical measures such as dimensions, volume, weight, surface finish etc. These specifications indicate tolerances on physical measures which provide production department with precise information about the characteristics of products to be produced and the processes and production equipments to be used to achieve the specified tolerances (acceptable variations).

Interchangeability of parts in products produced in large volumes (mass production and flow-line production) is provided by appropriate specification of tolerances to facilitate the desired fit between parts which are assembled together.

- (x) **Safety:** The product must be safe to the user and should not cause any accident while using or should not cause any health hazard to the user. Safety in storage, handling and usage must be ensured by the designer and a proper package has to be provided to avoid damage during transportation and storage of the product. For example, a pharmaceutical product while used by the patient, should not cause some other side effect threatening the user.



3.2 PROCESS DESIGN & SELECTION

Process Design is concerned with the overall sequences of operations required to achieve the product specifications. It specifies the type of work stations to be used, the machines and equipments necessary to carry out the operations. The sequence of operations are determined by (a) the nature of the product, (b) the materials used, (c) the quantities to be produced and (d) the existing physical layout of the plant.

The process design is concerned with the following:

- (i) Characteristics of the product or service offered to the customers.
- (ii) Expected volume of output.
- (iii) Kinds of equipments and machines available in the firm.
- (iv) Whether equipments and machines should be of special purpose or general purpose.
- (v) Cost of equipments and machines needed.
- (vi) Kind of labour skills available, amount of labour available and their wage rates.
- (vii) Expenditure to be incurred for manufacturing processes.
- (viii) Whether the process should be capital-intensive or labour-intensive.
- (ix) Make or buy decision.
- (x) Method of handling materials economically.

3.3 PROCESS PLANNING

Process Planning

Process planning refers to the way production of goods or services is organised. It is the basis for decisions regarding capacity planning, facilities (or plant) layout, equipments and design of work systems. Process selection is necessary when a firm takes up production of new products or services to be offered to the customers.

Three primary questions to be addressed before deciding on process selection are:

- (i) How much variety of products or services will the system need to handle?
- (ii) What degree of equipment flexibility will be needed?
- (iii) What is the expected volume of output?

Process Strategy

A **process strategy** is an organisation's approach to process selection for the purpose of transforming resource inputs into goods and services (outputs). The objective of a process strategy is to find a way to produce goods and services that meet customer requirement and product specification (i.e., design specifications) within the constraints of cost and other managerial limitations. The process selected will have a long-term effect on efficiency and production as well as flexibility, cost, and quality of the goods produced. Hence it is necessary that a firm has a sound process strategy at the time of selecting the process.

Key aspects in process strategy include:

- (i) Make or buy decisions
- (ii) Capital intensity and
- (iii) Process flexibility

Make or buy decisions refer to the extent to which a firm will produce goods or provide services in-house or go for outsourcing (buying or subcontracting).

Capital intensity refers to the mix of equipment and labour which will be used by the firm.

Process Flexibility refers to the degree to which the system can be adjusted to changes in processing requirements due to such factors as changes in product or service design, changes in volume of products produced and changes in technology.

Three process strategies: Virtually every good or service is made by using some variation of one of three process strategies. They are: **(i) process focus (ii) repetitive focus and (iii) product focus.**

Exhibit 1 illustrates the relationship between the three process strategies and volume and variety of products produced.

Each of these three strategies are discussed below:

(i) Process Focus: Majority (about 75 per cent) of global production is devoted to low volume, high variety products in manufacturing facilities called job shops. Such facilities are organised around performing processes. For example, the processes might be welding, grinding or painting carried out in departments devoted to these processes. Such facilities are **process focussed** in terms of equipment, machines, layout and supervision. They provide a high degree of product flexibility as products move intermittently between processes. Each process is designed to perform a wide variety of activities and handle frequent changes. Such processes are called **intermittent processes**. These facilities have high variable costs and low utilisation of facilities.

(ii) Repetitive Focus: A repetitive process is a product oriented production process that uses modules. It falls between product focus and process focus. It uses modules which are parts or components prepared often in a continuous or mass production process.

A good example of repetitive process is the **assembly line** which is used for assembling automobiles and household appliances and is less flexible than process-focused facility. Personal computer is an example of a repetitive process using modules in which the modules are assembled to get a custom product with the desired configuration.

(iii) Product Focus: It is a facility organised around products, a product oriented, high-volume low-variety process. It is also referred to as **continuous process** because it has very long continuous production run. Examples of product focussed processes are steel, glass, paper, electric bulbs, chemicals and pharmaceutical products, bolts and nuts etc. Product-focussed facilities need standardisation and effective quality control. The specialised nature of the facility requires high fixed cost, but low variable costs reward high facility utilisation.

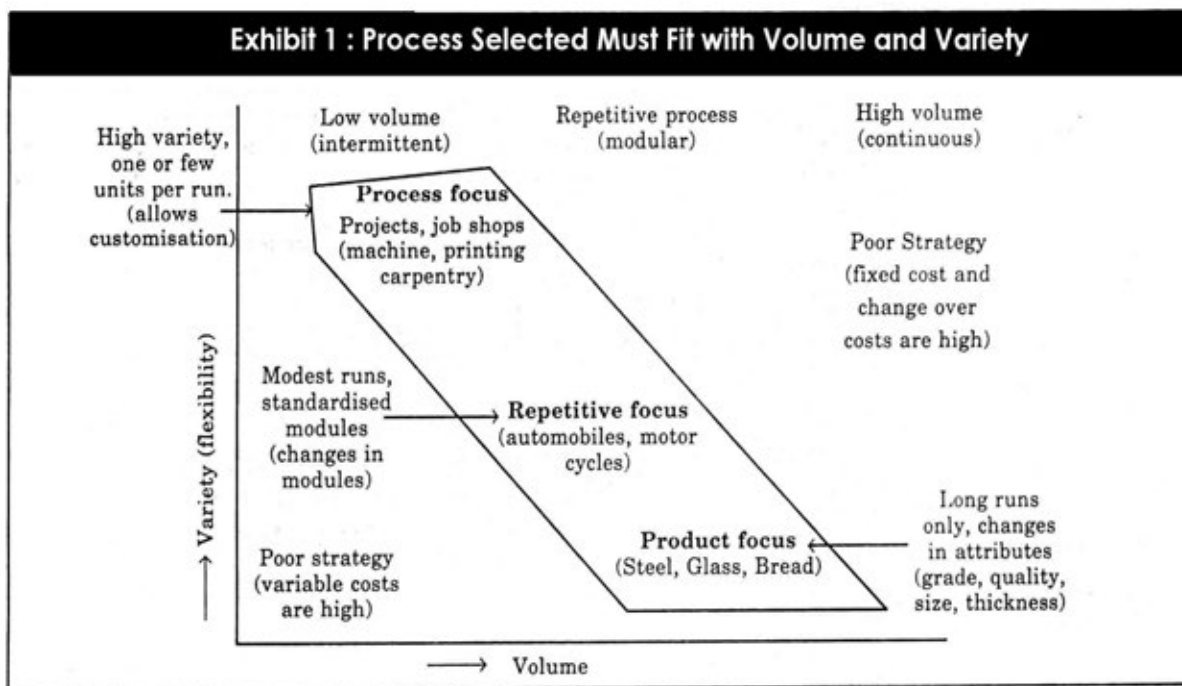

Table: Gives a comparison of three choices namely process focus, repetitive focus and product focus.

3.4 PRODUCT LIFE CYCLE

Products, like men, are mortal. They flourish for a time, then decline and die. The life cycle of a product has many points of similarity with the human life cycle. A product is born, grows lustily, attains a dynamic maturity, then enters its declining years. Like a human being a product that has not built up its potential during its formative years is likely to be relatively unsuccessful on its maturity. But, there are critical differences between the product and the human life cycle. For instance, every person has an average life expectancy. But the life expected of a product varies widely.

The concept of product failure is applicable both to new products and the existing ones. There may, however, be varying periods of life spans for each product: some failing immediately, other living for a longer period. The product, thus, has "life cycles" just as human beings have. From its birth, a product passes through various stages, until it is finally abandoned, *i. e.* discontinued from the market. These stages taken together are referred, to as "the product life cycle". This life cycle of the product comprises of four stages: Introduction, Growth, Maturity and Decline. It should be noted that it is purely a theoretical concept.

This may graphically be represented as shown **Fig.** in below:

The **introduction stage** is preceded by 'production planning and development'. This period requires greater investment. This investment should be gradually recouped as the sales pick up. The concept of life cycle would give the management an idea as to the time within which the original investment could be recouped.

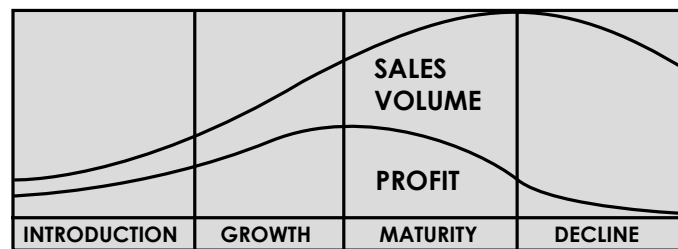

Fig. : Product life Cycle.

After testing, a product enters the introduction stage and the product will then become available in the national market. Sales would begin gradually as potential buyers come to know about the product through advertising and other selling techniques. But the profits will be low as part of the investment is to be recouped besides heavy expenditure on selling.

In the **growth stage**, both sales and profits will begin to increase. It is here that similar other new products begin to appear in the market as substitutes and offer competition. The management, therefore, should try to change its approach by changing its strategy from "buy my product" to "try my product". At the end of this stage, the distribution arrangement is likely to get completed and the prices, if necessary, are reduced a little.

The third stage is the **maturity stage**. During this stage the manufacturers introduce new models or adopt methods such as trading-in, etc., to promote the sale of their brands with a view to retaining their position in the market. The number of buyers will continue to grow, but more slowly. In economic terms this is the stage where supply exceeds demand. Some of the promotional efforts may lengthen the span of this stage but they will not offer a permanent solution.

At the final stage of **decline**, profit margins touch a low level, competition becomes severe and customers start using newer and better products. It is here that the story of a product ends-a natural but hard end.

The above discussion concentrates only on the life cycle of a product, beginning with its introduction into the market (*i.e.*, post-marketing). But a series of processes are to be undertaken by the management prior to the introduction of a product. The diagram given above is presented in an enlarged form to incorporate the pre-introduction (or pre-marketing) stages also.



Product life cycle concept may be used as a managerial tool. Marketing strategies must change as the product goes through the life cycle. If managers understand the cycle concept they are in a better position to forecast the future sales activities and plan marketing strategies. The following points, however, may be kept in mind in using this concept.

3.5 PROCESS SELECTION

Process choice determines whether resources are organised around products or processes in order to implement the flow strategy. It depends on the volumes and degree of customisation to be provided.

These major process decisions are discussed in detail in the following paragraphs:

1. **Process Choice:** The production manager has to choose from five basic process types — (i) job shop, (ii) batch, (iii) repetitive or assembly line, (iv) continuous and (v) project.
 - (i) **Job shop process:** It is used in job shops when a low volume of high-variety goods are needed. Processing is intermittent, each job requires somewhat different processing requirements. A job shop is characterised by high customisation (made to order), high flexibility of equipment and skilled labour and low volume. A tool and die shop is an example of job shop, where **job process** is carried out to produce one-of-a kind of tools. Firms having job shops often carry out job works for other firms. A job shop uses a flexible flow strategy, with resources organised around the process.
 - (ii) **Batch process:** Batch processing is used when a moderate volume of goods or services is required and also a moderate variety in products or services. A batch process differs from the job process with respect to volume and variety. In batch processing, volumes are higher because same or similar products or services are repeatedly provided, examples of products produced in batches include paint, ice cream, soft drinks, books and magazines.
 - (iii) **Repetitive process:** This is used when higher volumes of more standardised goods or services are needed. This type of process is characterised by slight flexibility of equipment (as products are standardised) and generally low labour skills. Products produced include automobiles, home appliances, television sets, computers, toys etc. Repetitive process is also referred to as **line process** as it include **production lines** and **assembly lines** in mass production. Resources are organised around a product or service and materials move in a line flow from one operation to the next according to a fixed sequence with little work-in-progress inventory. This kind of process is suitable to “**manufacture-to-stock**” strategy with standard products held in finished goods inventory. However, “**assemble-to-order**” strategy and “**mass customisation**” are also possible in repetitive process.
 - (iv) **Continuous process:** This is used when a very highly standardised product is desired in high volumes. These systems have almost no variety in output and hence there is no need for equipment flexibility. A continuous process is the extreme end of high volume, standardised production with rigid line flows. The process often is capital intensive and operate round the clock to maximise equipment utilisation and to avoid expensive shut downs and shut ups. Examples of products made in continuous process systems include petroleum products, steel, sugar, flour, paper, cement, fertilisers etc.
 - (v) **Project process:** It is characterised by high degree of job customisation, the large scope for each project and need for substantial resources to complete the project. Examples of projects are building a shopping centre, a dam, a bridge, construction of a factory, hospital, developing a new product, publishing a new book etc. Projects tend to be complex, take a long time and consist of a large number of complex activities. Equipment flexibility and labour skills can range from low to high depending on the type of projects.





Study Note - 4

PRODUCTION PLANNING AND CONTROL



This Study Note includes

- 4.1 Production Planning and Control Introduction
- 4.2 Time Study, Work Study, Method Study & Job Evaluation
- 4.3 Job Allocation – Assignment Technique
- 4.4 Scheduling
- 4.5 Queuing Models
- 4.6 Simulation
- 4.7 Line Balancing
- 4.8 Lean Operations
- 4.9 Just-In-Time (JIT)
- 4.10 Transportation Model
- 4.11 Linear Programming Technique

4.1 PRODUCTION PLANNING AND CONTROL INTRODUCTION

Introduction

Production planning control can be viewed as the nervous system of a production operation. The primary concern of production planning and control is the delivery of products to customers or to inventory stocks according to some predetermined schedule. All the activities in the manufacturing or production cycle must be planned, coordinated, organised, and controlled to achieve this objective. From a long-term point of view (usually from seven to ten years or more) production planning largely deals with plant construction and location and with product-line, design and development. Short-range planning (from several months to a year) focuses on such areas as inventory goals and wage budgets. In plans projected over a two-to-five year period, capital-equipment budgeting and plant capacity and layout are the major concern. Production planning and control normally reflects the short range activities and focuses on the issues and problems that arise in the planned utilisation of the labour force, materials, and physical facilities that are required for manufacturing the products in accordance with the primary objectives of the firm.

Production systems are usually designed to produce a variety of products and are, therefore, complex. In such complex systems, anything can happen and usually it is so. Therefore, it is vital to exercise some kind of control over the production activities. Control is possible only when everything is planned. Production planning and control is thus a very important aspect of production management.

Objectives of production planning and control

The ultimate objective of production planning and control is to contribute to the profits of the enterprise. This is accomplished by keeping the customers satisfied through the meeting of delivery schedules. Further, the specific objectives of production planning and control are to establish the routes and schedules for work that will ensure the optimum utilisation of raw materials, labourers, and machines to provide the means for ensuring the operation of the plant in accordance with these plans. Production planning and control is essentially concerned with the control of work-in-process. To control work-in-process effectively it becomes necessary to control not only the flow of material but also the utilisation of people and machines.

Production planning and control fulfils these objectives by focusing on the following points:

- (i) Analysing the orders to determine the raw materials and parts that will be required for their completion,
- (ii) Answering questions from customers and salesmen concerning the status of their orders,
- (iii) Assisting the costing department in making cost estimates of orders,
- (iv) Assisting the human resource departments in the manpower planning and assignment of men to particular jobs,
- (v) Controlling the stock of finished parts and products,
- (vi) Determining the necessary tools required for manufacturing,
- (vii) Direction and control of the movement of materials through production process,
- (viii) Initiating changes in orders as requested by customers while orders are in process,
- (ix) Issuing requisitions for the purchase of necessary materials,
- (x) Issuing requisitions for the purchase or manufacture of necessary tools and parts,
- (xi) Keeping the up-to-date records scheduled and in process,
- (xii) Maintaining stocks of materials and parts,
- (xiii) Notifying sales and accounting of the acceptance of orders in terms of production feasibility,
- (xiv) Preparing the route sheets and schedules showing the sequence of operation required to produce particular products,
- (xv) Production of work orders to initiate production activities,
- (xvi) Receiving and evaluating reports of progress on particular orders and initiating corrective action, if necessary,
- (xvii) Receiving orders from customers,
- (xviii) Revising plans when production activities cannot conform to original plans and when revisions in scheduled production are necessary because of rush orders.

Production control involves the following functions:

- (i) Planning the production operations in detail,
- (ii) Routing, i.e., laying down the path for the work to follow and the order in which the various operations will be carried out,
- (iii) Scheduling, i.e., establishing the quantity of work to be done, and fixing the time table for performing the operations,
- (iv) Dispatching, i.e., issuing the necessary orders, and taking necessary steps to ensure that the time targets set in the schedules are effectively achieved,
- (v) Follow-up, taking necessary steps to check up whether work proceeds according to predetermined plans and how far there are variances from the standards set earlier,
- (vi) Inspection, i.e., conducting occasional check-ups of the products manufactured or assembled to ensure high quality of the production.

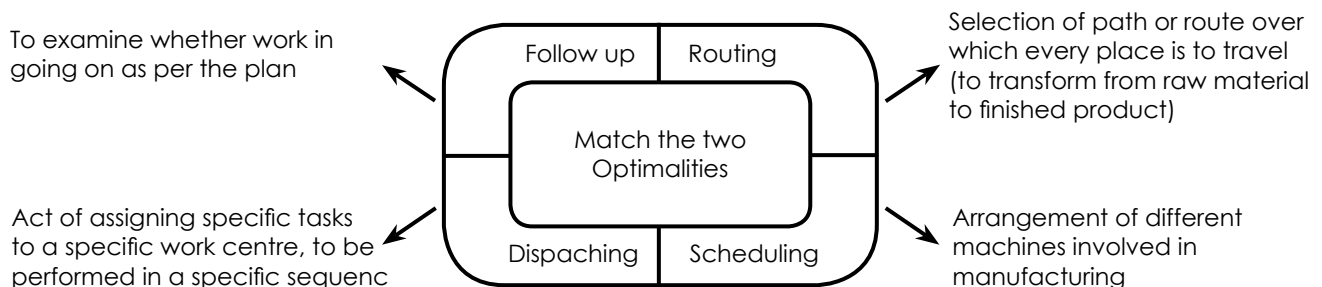

Figure : Techniques of Production Control

**Basic types of production control:**

Production control can be of six types:

(i) Block control

This type of control is most prominent in textiles and book and magazine printing. In these industries it is necessary to keep things separated and this is the fundamental reason why industries resort to block control.

(ii) Flow control

This type of control is commonly applied in industries like chemicals, petroleum, glass, and some areas of food manufacturing and processing. Once the production system is thoroughly designed, the production planning and control department controls the rate of flow of work into the system and checks it as it comes out of the system. But, under this method, routing and scheduling are done when the plant is laid out. That is to say, the production line which is established is well balanced and sequenced before production operations begin; this type of control is more prevalent in continuous production systems.

(iii) Load control

Load control is typically found wherever a particular bottleneck machine exists in the process of manufacturing.

(iv) Order control

The most, common type of production control is called order control. This type of control is commonly employed in companies with intermittent production systems, the so-called job-lot shops. Under this method, orders come into the shop for different quantities for different products. Therefore, production planning and control must be based, on the individual orders.

(v) Special project control

Special production control is necessary in certain projects like the construction of bridges, office buildings, schools, colleges, universities, hospitals and any other construction industries. Under this type of control, instead of having sets of elaborate forms for tooling and scheduling, a man or a group of men keeps in close contact with the work.

(vi) Batch control

Batch control is another important, type of production control which is frequently found in the food processing industries. Thus, production control in batch-system of control operates with a set of

Production planning and control in continuous-production systems.

Production systems may be continuous or intermittent. The continuous production systems are characterised by:

- (i) Fixed-path material handling equipment,
- (ii) High volume of production,
- (iii) Product layouts,
- (iv) Production of standardised products,
- (v) Production to stock or long-range orders,
- (vi) The use of special-purpose machines or automation.

Production planning and control in continuous-production systems involve two activities:

- (i) Assuring that supply of raw materials and supplies are on hand to keep the production system supplied and assuring that finished products are moved from the production-system,
- (ii) Maintaining a constant rate of flow of the production, so that the system can operate near capacity in some case or can meet the quantity requirements of the production.



Production planning in intermittent production systems:

The intermittent production systems are characterized by the following:

- (i) General purpose production machines are normally utilised and process layout is favoured.
- (ii) Materials handling equipment is typically of the varied path type such as hand trucks and forklift trucks.
- (iii) Relatively high cost, skilled labour is needed to turn out the various quantities and types of products.
- (iv) The company generally manufactures a wide variety of products; for the majority of items, sales volumes and consequently production order sizes are small in relation to the total production.

4.2 TIME STUDY, WORK STUDY, METHOD STUDY, JOB EVALUATION

Time Study:

Time study is defined to be a searching scientific analysis of the methods and equipment used or planned in doing a piece of work, development in practical detail of the best manner of doing it and determination of the time required.

Operation analysis is the study of the entire process to determine whether operations can be eliminated, combined or the sequence changed. Operation analysis aims to determine the one best way and can be applied to method, materials, tools equipment layout, working conditions and human requirements of each operation.

Job standardisation consists in determining the one best way of performing a job under the means at command of recording the exact method along with the time for each element of operation and establishing means to maintain the standard conditions.

Another term connected with time and motion study is the job analysis. Job analysis is the determination of essential factors in a specific kind of work and of the qualifications of a worker necessary for its performance.

Time study aims at determining the best manner of doing a job and timing the performance of the job when done in the best manner.

In motion study the work is divided into fundamental motions and in time study work is divided into elements of operations. In both cases attempts are made to remove useless motions and improve combination and sequences of motions and operations. In motion study the best way of doing a work is determined by motion analysis and operators are trained to follow the method so determined but in time study the best method is determined by analysis of the methods and equipment, used and motions only roughly considered and that too indirectly. In time study, setting of production standards, standards for cost purposes and wage incentives are emphasised. The measurement of human effort is a difficult job which can only be solved by using scientific method and industrial experience combined with knowledge of psychology.

The use of scientific method involves experiment measurement and elimination of variables connected with a job.

The variables connected with a job are the method of manufacture, tools and equipments, material, working conditions, worker concerned and time required to perform the job. In order to measure the last variable time, the other variables must be eliminated by standardising. In going to proceed for time study, it is first necessary to standardise the method and conditions of work and to define what an average worker is. Time study has two sides, mechanical and human.

Before commencing the time study, the time study man should ensure and ascertain the following:

- (i) That motion studies have been carried out so that planning of work, work places and appliances are satisfactory.
- (ii) That the operations can be performed in the correct; sequence without interruption.
- (iii) That the human effort involved is minimum.

**Work Study:**

It is a general term for the techniques: methods study and work measurement which are used in the examination; of human work in all its contexts and systematically investigate all factors leading to improvement of efficiency.

Work study aims at finding the best and most efficient way of using the available resources—men, materials, money and machinery. Once the method study has developed an improved procedure for doing a work the work measurement or time study will study the time to complete a job.

Method Study:

It is the systematic investigation of the existing method of doing a job in order to develop and install an easy, rapid, efficient, effective and less fatiguing procedure for doing the same job and at minimum cost. This is achieved by eliminating unnecessary motions involved in a certain operation or by changing the sequence of operation or the process itself.

Methods study can be made by the help of both motion study and time study.

The methods study programme must include the following features:—

- (a) Uniform application,
- (b) Established standard practice,
- (c) Continuous review,
- (d) Credit distribution.

A new and improved method developed in one department should be spread out to the entire plant preferably with further improvements.

A new method must not be forgotten between orders as it happens sometimes in batch production. Methods department should always aim at improved and better ways of doing jobs.

For successful control of methods study, the enthusiastic cooperation of every employee is required. To gain employee cooperation, distribution of credit is essential. It has been correctly said that a good methods department rarely takes credit for an original idea. Its success lies in getting new ways and methods adopted promptly, universally, continuously and cooperatively towards the improvement of productivity.

Job Evaluation:

Job evaluation is the ranking grading, and weighing of essential work characteristics of all jobs in order to find out or rate the worth of jobs. It is a systematic approach to ascertain the labour worth of each job and is a very important concern of all employers.

Job evaluation aims at fairness and consistency so far as all wages and salaries are concerned within an organisation and when systematic and impartial, it stimulates, confidence of the employees. There are three steps for evaluations of all jobs :—

- (i) Preparation of preliminary description of each existing job.
- (ii) Analysing each job to arrive at final job descriptions and specifications.
- (iii) Analysing each job according to its approved description in order to determine its worth or value.

Job Description and Specifications: The understanding of the job content or job description is the primary requirement.

Job specifications are derived from the job descriptions which have already been approved. The specification help determining the qualification required of the individual desired for the position. This in turn guides the personnel department in the selection of employees and also guides shop executives in the placement of workmen.



Systems of Valuation: There are several systems of job evaluation.

The fundamental criteria in valuation of a job into account are to make a specific list of factors which affect job values. The many factors are:

- (i) Qualifications required of the worker,
- (ii) Job difficulties,
- (iii) Job responsibilities,
- (iv) Working conditions.

All these factors are to be analysed in detail in order to complete the job description. The list of factors, the manner in which they are appraised and the method of finding out relative worth and money values distinguishes the various systems of valuation.

The systems of valuations which are commonly adopted are given below:

1. The ranking or grading method,
2. The factor comparison method,
3. Point rating method.

Ranking or Grading Method: Under this system the titles of all jobs are written on cards and the grading is done by several competent judges. The hourly rates to be paid for different jobs are suggested by the judges without any consideration to the existing wage. The ranks or grades assigned to each job by all the judges are averaged and this average is considered the "score" for that job. Hourly rates are then fixed for jobs according to their ranking.

Factor Comparison Method: The factor comparison method analyses the job into much greater detail than the grading method. It ranks each job with respect to each factor that characterise the job and the factors are taken one at a time.

All jobs are compared and ranked first with respect to mental requirements, then skill, then physical requirements and after that responsibility and lastly working conditions. The total worth of the job is obtained by adding together money values which are assigned separately to the various levels of rank in each factor. Factor comparison method is more accurate than the simple ranking systems, since the separate factors are analysed comparatively. This method is flexible.

Point Rating Method: There are three methods of analytical evaluation of a job. They are:

1. Straight point method.
2. Weighted point method.
3. Valuation of jobs directly in money method, not specifying any maximum weight.

(i) Straight Point Method: This method assigns equal weights for each characteristic. When evaluating a job under this system, it is assumed that all the characteristics have ranges of values between same maximum and minimum points.

(ii) Weighted Point Method: In this method different points are assigned to the different characteristics of doing jobs.

(iii) Direct to Money Methods: After selecting the job characteristics, ten key jobs whose rates are believed to be correct, are taken and the present wage rates of these jobs are distributed to the job characteristics by each analyst. The jobs are then ranked by the analysts for each characteristic in order of the degree to which that characteristic is present. This serves as a check to show up any errors made in the original distribution of the wages rate to the various characteristics.



4.3 JOB ALLOCATION – ASSIGNMENT TECHNIQUE

ASSIGNMENT

Assignment is a special linear programming problem. There are many situations where the assignment of people or machines etc. may be called for. Assignment of workers to machines, clerks to various check-out counters, salesmen to different sales areas are typical examples of these. The Assignment is a problem because people possess varying abilities for performing different jobs and therefore the costs of performing jobs by different people are different. Thus, in an assignment problem, the question is how the assignments should be made in order that the total cost involved is minimized.

There are four methods of solving an assignment problem and they are:

1. Complete Enumeration Method
2. Simplex Method
3. Transportation Method and
4. Hungarian Method

Hungarian Method:

The following are the steps involved in the minimization of an assignment problem under this method:

Step 1: Row Operation

Locate the smallest cost element in each row of the given cost table. Now subtract this smallest element from each element in that row. As a result, there shall be at least one zero in each row of this new table, called the reduced cost table.

Step 2: Column Operation

In the reduced cost table obtained, consider each column and locate the smallest element in it. Subtract the smallest value from every entry in the column. As a consequence of this action, there would be at least one zero in each of the rows and columns of the second reduced cost table.

Step 3: Optimality

Draw the minimum no. of horizontal and vertical lines (not the diagonal ones) that are required to cover all the zero elements. If the no. of lines drawn is equal to 'n' (the no. of rows/columns of the given Cost Matrix) the solution is optimal and proceed to step 6. If the no. of lines drawn is smaller than 'n' go to step 4.

Step 4: Improved Matrix

Select the smallest uncovered (by the lines) cost element. Subtract this element from all uncovered elements including itself and add this element to each value located at the intersection of any two lines. The cost elements through which only one line passes remain unaltered.

Step 5: Repeat step 3 and 4 until an optimal solution is obtained.

Step 6: Given the optimal solution, make the job assignments as indicated by the 'zero' elements. This is done as follows:

- (a) Locate a row which contains only one zero element. Assign the job corresponding to this element to its corresponding person. Cross out the zero's if any in the column corresponding to the element, which is indicative of the fact that the particular job and person are no more available.
- (b) Repeat (a) for each of such rows which contain only one zero. Similarly, perform the same operation in respect of each column containing only one 'zero' element, crossing out the zero(s), if any, in the row in which the elements lies.
- (c) If there is no row or column with only a single 'zero' element left, then select a row/column arbitrarily and choose one of the jobs (or persons) and make the assignment. Thus in such a case, alternative solutions exist.



Illustration 1.

Six men are available for different jobs. From past records the time in hours taken by different persons for different jobs are given below.

		Jobs					
		1	2	3	4	5	6
Men	1	2	9	2	7	9	1
	2	6	8	7	6	14	1
	3	4	6	5	3	8	1
	4	4	2	7	3	10	1
	5	5	3	9	5	12	1
	6	9	8	12	13	9	1

Find out an allocation of men to different jobs which will lead to minimum operation time.

Solution:

Man \ Job	1	2	3	4	5	6
1	2	9	2	7	9	1
2	6	8	7	6	14	1
3	4	6	5	3	8	1
4	4	2	7	3	10	1
5	5	3	9	5	12	1
6	9	8	12	13	9	1

Row Operation* (Table - 1)

Man \ Job	1	2	3	4	5	6
1	1	8	1	6	8	0
2	5	7	6	5	13	0
3	3	5	4	2	7	0
4	3	1	6	2	9	0
5	4	2	8	4	11	0
6	8	7	11	12	8	0

* Matrix is obtained by subtracting min. element of each row of the given Matrix from all the elements of the corresponding row.

Column Operation* (Table - 2)

Man \ Job	1	2	3	4	5	6
1	0	7	0	4	1	0
2	4	6	5	3	6	0
3	2	4	3	0	0	0
4	2	0	5	0	2	0
5	3	1	7	2	4	0
6	7	6	10	10	1	0

* Matrix is obtained by subtracting min. element of each column of Table - 1 from all the elements of the corresponding column.



Table - 3

Man \ Job	1	2	3	4	5	6
1	0	7	0	4	1	0
2	4	6	5	3	6	0
3	2	4	3	0	0	0
4	2	0	5	0	2	0
5	3	1	7	2	4	0
6	7	6	10	10	1	0

All the zeros obtained in Table - 2 are covered by minimum no. of horizontal and vertical straight lines and shown above. Here order of the given matrix = 6 and minimum no. of horizontal and vertical lines = 4.

As $4 \neq 6$, the solution is non optimal.

Table - 4

Man \ Job	1	2	3	4	5	6
1	0	7	0	4	1	1
2	3	5	4	2	5	0
3	2	4	3	0	0	1
4	2	0	5	0	2	1
5	2	0	6	1	3	0
6	6	5	9	9	0	0

Above table is obtained by subtracting minimum uncovered element of Table - 3 from all the uncovered elements and by adding the same to all the elements at the junction of the intersecting straight lines.

Minimum no. of horizontal and vertical straight lines to cover all the zeros = $5 \neq 6$ (order of the matrix). So the solution is non optimal.

Table - 5

Man \ Job	1	2	3	4	5	6
1	0	9	0	6	3	3
2	1	5	2	2	5	0
3	0	4	1	0	0	1
4	0	0	3	0	2	1
5	0	0	4	1	3	0
6	4	5	7	9	0	0

Above table is obtained by subtracting minimum uncovered element (2) of Table - 4 from all the uncovered elements and by adding the same to all the elements at the junction of the intersecting straight lines. Here minimum no. of horizontal or vertical straight lines to cover all the zeros = $6 =$ Order of the Matrix. So the solution is optimal.



Table - 6 Showing Optimum Solution - 1

Man \ Job	1	2	3	4	5	6
1	∞	9	0	6	3	3
2	1	5	2	2	5	0
3	0	4	1	∞	∞	1
4	∞	∞	3	0	2	1
5	∞	0	4	1	3	∞
6	4	5	7	9	0	∞

Table - 7 Showing Optimum Solution - 2

Man \ Job	1	2	3	4	5	6
1	∞	9	0	6	3	3
2	1	5	2	2	5	0
3	∞	4	1	0	∞	1
4	0	∞	3	∞	2	1
5	∞	0	4	1	3	∞
6	4	5	7	9	0	∞

Table - 8 Showing Optimum Solution - 3

Man \ Job	1	2	3	4	5	6
1	∞	9	0	6	3	3
2	1	5	2	2	5	0
3	∞	4	1	0	∞	1
4	∞	0	3	∞	2	1
5	0	∞	4	1	3	∞
6	4	5	7	9	0	∞



So the Optimal Assignments are as follows:—

As per Table - 6			As per Table - 7			As per Table - 8		
Man	Job	Time (hrs.)	Man	Job	Time (hrs.)	Man	Job	Time (hrs.)
1	3	2	1	3	2	1	3	2
2	6	1	2	6	1	2	6	1
3	1	4	3	4	3	3	4	3
4	4	3	4	1	4	4	2	3
5	2	3	5	2	3	5	1	5
6	5	9	6	5	9	6	5	9
Total	—	22	Total	—	22	Total	—	22

Minimum total operation time = 22 hrs.

Illustration 2.

A captain of a cricket team has to allot five middle batting positions to five batsmen. The average runs scored by each batsman at these positions are as follows:

		Batting Position				
		III	IV	V	VI	VII
Batsmen	A	40	40	35	25	50
	B	42	30	16	25	27
	C	50	48	40	60	50
	D	20	19	20	18	25
	E	58	60	59	55	53

Make the assignment so that the expected total average runs scored by these batsmen are maximum.

Solution:

This is a problem of Maximisation. To solve it using Assignment technique it has to be converted to a Minimisation problem by forming a Relative Loss Matrix.

		Batting Position				
Batsman		III	IV	V	VI	VII
A		40	40	35	25	50
B		42	30	16	25	27
C		50	48	40	60	50
D		20	19	20	18	25
E		58	60	59	55	53



Relative Loss Matrix*

Batsman	Batting Position				
	III	IV	V	VI	VII
A	20	20	25	35	10
B	18	30	44	35	33
C	10	12	20	0	10
D	40	41	40	42	35
E	2	0	1	5	7

* This matrix is formed by subtracting all the elements of the given matrix from the highest element (60) of it.

Row Operation Matrix

Batsman	Batting Position				
	III	IV	V	VI	VII
A	10	10	15	25	0
B	0	12	26	17	15
C	10	12	20	0	10
D	5	6	5	7	0
E	2	0	1	5	7

Column Operation Matrix

Batting Position Batsman	III	IV	V	VI	VII
A	10	10	14	25	0
B	0	12	25	17	15
C	10	12	19	0	10
D	5	6	4	7	0
E	2	0	0	5	7

Minimum no. of horizontal and vertical straight lines to cover all the zeros = 4 ≠ Order of the matrix(5). So the solution is non optimal.



Improved Matrix

Batsman	Batting Position				
	III	IV	V	VI	VII
A	10	6	10	25	0
B	0	8	21	17	15
C	10	8	15	0	10
D	5	2	0	7	∞
E	6	0	∞	9	11

Here minimum no. of horizontal and vertical straight lines to cover all the zeros = 5 = Order of the matrix.
So the solution is optimal.

Optimal Assignment

Batsman	Batting Position	Average runs scored
A	VII	50
B	III	42
C	VI	60
D	V	20
E	IV	60
Total =		232

Expected maximum total runs = 232

Illustration 3.

Average time taken by an operator on a specific machine is tabulated below. The management is considering replacing one of the old machines by a new one and the estimated time for operation by each operator on the new machine is also indicated.



Operator	Machines						
	M ₁	M ₂	M ₃	M ₄	M ₅	M ₆	New
01	2	3	2	1	4	5	6
02	4	4	6	3	2	5	1
03	6	10	8	4	7	6	1
04	8	7	6	5	3	9	4
05	7	3	4	5	4	3	12
06	5	5	6	7	8	1	6

- (a) Find out an allocation of operators to the old machines to achieve a minimum operation time.
- (b) Reset the problem with the new machine and find out the allocation of the operators to each machine and comment on whether it is advantageous to replace an old machine to achieve a reduction in operating time only.
- (c) How will the operators be reallocated to the machines after replacement?

Solution:

Operator	Machines						
	M ₁	M ₂	M ₃	M ₄	M ₅	M ₆	New
01	2	3	2	1	4	5	6
02	4	4	6	3	2	5	1
03	6	10	8	4	7	6	1
04	8	7	6	5	3	9	4
05	7	3	4	5	4	3	12
06	5	5	6	7	8	1	6

(a)

Operator	Machines					
	M ₁	M ₂	M ₃	M ₄	M ₅	M ₆
01	2	3	2	1	4	5
02	4	4	6	3	2	5
03	6	10	8	4	7	6
04	8	7	6	5	3	9
05	7	3	4	5	4	3
06	5	5	6	7	8	1

Matrix after Row Operation

Operator	Machines					
	M ₁	M ₂	M ₃	M ₄	M ₅	M ₆
01	1	2	1	0	3	4
02	2	2	4	1	0	3
03	2	6	4	0	3	2
04	5	4	3	2	0	6
05	4	0	1	2	1	0
06	4	4	5	6	7	0

To find out the allocation of the Old Machines to the operators we consider the given matrix without the new machine.



Matrix after Column Operation

Operator	Machines					
	M ₁	M ₂	M ₃	M ₄	M ₅	M ₆
01	0	2	0	0	3	4
02	1	2	3	1	0	3
03	1	6	3	0	3	2
04	4	4	2	2	0	6
05	3	0	0	2	1	0
06	3	4	4	6	7	0

Minimum no. of horizontal and vertical straight lines to cover all the zeros = 5 ≠ order of the matrix (6). So the solution is non optimal.

Improved matrix

Operator	Machines					
	M ₁	M ₂	M ₃	M ₄	M ₅	M ₆
01	∞	2	0	1	4	5
02	0	1	2	1	∞	3
03	∞	5	2	0	3	2
04	3	3	1	2	0	6
05	3	0	∞	3	2	1
06	2	3	3	6	7	0

Minimum no. of horizontal and vertical straight lines to cover all the zeros = 6 = Order of the matrix. So the solution is optimal.

Optimal Assignment

Operators	01	→	M ₃	-	2
	02	→	M ₁	-	4
	03	→	M ₄	-	4
	04	→	M ₅	-	3
	05	→	M ₂	-	3
	06	→	M ₆	-	1

17 Hours Minimum Operation Time

(b) & (c)

Operator	Machines						
	M ₁	M ₂	M ₃	M ₄	M ₅	M ₆	New
01	2	3	2	1	4	5	6
02	4	4	6	3	2	5	1
03	6	10	8	4	7	6	1
04	8	7	6	5	3	9	4
05	7	3	4	5	4	3	12
06	5	5	6	7	8	1	6
Dummy	0	0	0	0	0	0	0

With the introduction of a new machine into the system, the problem becomes unbalanced one. To make it balanced, a Dummy operator is introduced and all the elements of the matrix corresponding to it are taken as zero.

**(1) Matrix after Row Operation**

Operator	Machines						
	M ₁	M ₂	M ₃	M ₄	M ₅	M ₆	New
01	1	2	1	0	3	4	5
02	3	3	5	2	1	4	0
03	5	9	7	3	6	5	0
04	5	4	3	2	0	6	1
05	4	0	1	2	1	0	9
06	4	4	5	6	7	0	5
Dummy	0	0	0	0	0	0	0

As all the columns contain zeros, the matrix after column operation will remain same. So the operation need not be done.

Here minimum no. of horizontal and vertical straight lines to cover all the zeros = 6 \neq order of the matrix(7). So the solution is non optimal.

(2) Improved Matrix

Operator	Machines						
	M ₁	M ₂	M ₃	M ₄	M ₅	M ₆	New
01	0	1	0	0	3	4	5
02	2	2	4	2	1	4	0
03	4	8	6	3	6	5	0
04	4	3	2	2	0	6	1
05	4	0	1	3	2	1	10
06	3	3	4	6	7	0	5
Dummy	0	0	0	1	1	1	1

Here minimum no. of horizontal and vertical straight lines to cover all the zeros = 6 \neq order of the matrix(7). So the solution is non optimal.



(3) Improved Matrix

Operator	Machines						
	M ₁	M ₂	M ₃	M ₄	M ₅	M ₆	New
01	0	2	0	0	4	5	6
02	1	2	3	1	1	4	0
03	3	8	5	2	6	5	0
04	3	3	1	1	0	6	1
05	3	0	0	2	2	1	10
06	2	3	3	5	7	0	5
Dummy	0	1	0	1	2	2	2

Here minimum no. of horizontal and vertical straight lines to cover all the zeros = 6 ≠ order of the matrix(7). So the solution is non optimal.

(4) Improved Matrix Showing Optimal Solution (i)

Operator	Machines						
	M ₁	M ₂	M ₃	M ₄	M ₅	M ₆	New
01	0	2	∞	∞	5	6	7
02	∞	1	2	0	1	4	∞
03	2	7	4	1	6	5	0
04	2	2	∞	∞	0	6	1
05	3	0	∞	2	3	2	11
06	1	2	2	4	7	0	5
Dummy	∞	1	0	1	3	3	3

Here minimum no. of horizontal and vertical straight lines to cover all the zeros = 7 = order of the matrix. So the solution optimal.

Improved Matrix Showing Optimal Solution (ii)

Operator	Machines						
	M ₁	M ₂	M ₃	M ₄	M ₅	M ₆	New
01	∞	2	0	∞	5	6	7
02	∞	1	2	0	1	4	∞
03	2	7	4	1	6	5	0
04	2	2	∞	∞	0	6	1
05	3	0	∞	2	3	2	11
06	1	2	2	4	7	0	5
Dummy	0	1	∞	1	3	3	3



Improved Matrix Showing Optimal Solution (iii)

Operator	Machines						
	M ₁	M ₂	M ₃	M ₄	M ₅	M ₆	New
01	∅	2	∅	0	5	6	7
02	0	1	2	∅	1	4	∅
03	2	7	4	1	6	5	0
04	2	2	∅	∅	0	6	1
05	3	0	∅	2	3	2	11
06	1	2	2	4	7	0	5
Dummy	∅	1	0	1	3	3	3

Table Showing Multiple Optimum Allocations

Solution (i)			Solution (ii)			Solution (iii)		
Operators	M/C	Time (Hrs.)	Operators	M/C	Time (Hrs.)	Operators	M/C	Time (Hrs.)
01	M ₁	2	01	M ₃	5	01	M ₄	1
02	M ₄	3	02	M ₄	1	02	M ₁	4
03	New	1	03	New	6	03	New	1
04	M ₅	3	04	M ₅	0	04	M ₅	3
05	M ₂	3	05	M ₂	3	05	M ₂	3
06	M ₆	1	06	M ₆	7	06	M ₆	1
Dummy	M ₃	0	Dummy	M ₁	3	Dummy	M ₃	0
Total	–	13*	Total	–	13*	Total	–	13*

* Minimum Operation Time

From above it can be said that replacement of an old machine with the new one will result in a reduction in Total Operating Time by 17-13 = 4 Hours. So replacement decision is advantageous.

As per solutions (i) & (iii) above, Machine M₃ should be replaced by a New Machine and as per Solution (iii), M₁ should be replaced by a New one.

Illustration 4.

Six salesmen are to be allocated to six sales regions so that the cost of allocation of the job will be minimum. Each salesman is capable of doing the job at different cost in each region. The cost matrix is given below:

		Region					
		I	II	III	IV	V	VI
Salesmen	A	15	35	0	25	10	45
	B	40	5	45	20	15	20
	C	25	60	10	65	25	10
	D	25	20	35	10	25	60
	E	30	70	40	5	40	50
	F	10	25	30	40	50	15

(Figures are in Rupees)



- (a) Find the allocation to give minimum cost. What is the minimum cost?
- (b) Now suppose the above table gives earning of each salesman at each region. How can you find an allocation so that the earning will be maximum? Determine the solution with optimum earning.
- (c) There are restrictions for commercial reasons that A cannot be posted to region V and E cannot be posted to region II. Write down the cost matrix suitably after imposing the restrictions.

Solution:

Matrix after Row Operation

Salesman	Region					
	I	II	III	IV	V	VI
A	15	35	0	25	10	45
B	40	5	45	20	15	20
C	25	60	10	65	25	10
D	25	20	35	10	25	60
E	30	70	40	5	40	50
F	10	25	30	40	50	15

Salesman	Region					
	I	II	III	IV	V	VI
A	15	35	0	25	10	45
B	35	0	40	15	10	15
C	15	50	0	55	15	0
D	15	10	25	0	15	50
E	25	65	35	0	35	45
F	0	15	20	30	40	5

Matrix after Column Operation

Salesman	Region					
	I	II	III	IV	V	VI
A	15	35	0	25	10	45
B	35	0	40	15	0	15
C	15	50	0	55	5	0
D	15	10	25	0	5	50
E	25	65	35	0	25	45
F	0	15	20	30	30	5

Improved Matrix (Optimal)

Salesman	Region					
	I	II	III	IV	V	VI
A	20	35	0	30	8	45
B	40	0	40	20	8	15
C	20	50	8	60	5	0
D	15	5	20	8	0	45
E	25	60	30	0	20	40
F	0	10	15	30	30	8

Here minimum no. of horizontal and vertical straight lines to cover all the zeros = 5 ≠ Order of the matrix (6). So the solution is non optimal.

Here minimum no. of horizontal and vertical straight lines to cover all the zeros = 6 = Order of the matrix. So the solution is optimal.

Table showing optimal allocation

Salesman	Region	Cost (₹)
A	III	0
B	II	5
C	VI	10
D	V	25
E	IV	5
F	I	10
Total		₹ 55

Minimum Cost



(b) The given problem is a problem of Maximisation. To convert it to a problem of Minimisation, a Relative Loss Matrix is formed by subtracting all the elements of the given matrix from the highest element (70).

Relative Loss Matrix

Salesman	Region					
	I	II	III	IV	V	VI
A	55	35	70	45	60	25
B	30	65	25	50	55	50
C	45	10	60	5	45	60
D	45	50	35	60	45	10
E	40	0	30	65	30	20
F	60	45	40	30	20	55

Matrix after Row Operation

Salesman	Region					
	I	II	III	IV	V	VI
A	30	10	45	20	35	0
B	5	40	0	25	30	25
C	40	5	55	0	40	55
D	35	40	25	50	35	0
E	40	0	30	65	30	20
F	40	25	20	10	0	35

Matrix after Column Operation

Salesman	Region					
	I	II	III	IV	V	VI
A	25	10	45	20	35	0
B	0	40	0	25	30	25
C	35	5	55	0	40	55
D	30	40	25	50	35	0
E	35	0	30	65	30	20
F	35	25	20	10	0	35

Improved Matrix

Salesman	Region					
	I	II	III	IV	V	VI
A	5	10	25	20	35	0
B	0	60	0	15	50	45
C	15	5	35	0	40	55
D	10	40	5	50	35	0
E	15	0	10	65	30	20
F	15	25	0	10	0	35

Here minimum no. of horizontal and vertical straight lines to cover all the zeros = 5 ≠ Order of the matrix (6). So the solution is non optimal.

Here minimum no. of horizontal and vertical straight lines to cover all the zeros = 5 ≠ Order of the matrix (6). So the solution is optimal.

Improved Matrix (Optimal)

Salesman	Region					
	I	II	III	IV	V	VI
A	0	10	20	20	30	0
B	0	65	0	50	50	50
C	10	5	30	0	35	55
D	5	40	0	50	30	0
E	10	0	5	65	25	20
F	15	30	0	15	0	40

Table Showing Optimal Allocation

Salesman	Region	Earning (₹)
A	I	15
B	III	45
C	IV	65
D	VI	60
E	II	70
F	V	50
Total		₹ 305

Maximum Earning

Here minimum no. of horizontal and vertical straight lines to cover all the zeros = 6 = Order of the matrix. So the solution is optimal.



(c) The cost matrix after imposing the given restriction is

		Region					
		I	II	III	IV	V	VI
Sales man	A	15	35	0	25	α	45
	B	40	5	45	20	15	10
	C	25	60	10	65	25	10
	D	25	20	35	10	25	60
	E	30	α	40	5	40	50
	F	10	25	30	40	50	15

Cost (figures are in ₹)

(Whenever such restrictions are imposed, we have to consider the corresponding element of the given matrix as infinitely large i.e. α)

Illustration 5.

Four jobs can be processed on four different machines, with one job on one machine. Resulting profits vary with assignments. They are given below:

		Machines			
		A	B	C	D
Jobs	I	42	35	28	21
	II	30	25	20	15
	III	30	25	20	15
	IV	24	20	16	12

Find the optimum assignment of jobs to machines and the corresponding profit.

Solution:

Relative Loss Matrix

Jobs \ M/cs	A	B	C	D
I	0	7	14	21
II	12	17	22	27
III	12	17	22	27
IV	18	22	26	30

As this is a problem of Maximisation, the same is converted to one of Minimisation by forming a Relative Loss Matrix where all the elements of the given matrix are subtracted from the highest element of the matrix (which is 42 in this case)

Matrix after Row Operation

Jobs \ M/cs	A	B	C	D
I	0	7	14	21
II	0	5	10	15
III	0	5	10	15
IV	0	4	8	12



Matrix after Column Operation

Jobs \ M/cs	A	B	C	D
I	0	3	6	9
II	0	1	2	3
III	0	1	2	3
IV	0	0	0	0

Here minimum no. of horizontal and vertical straight lines to cover all the zeros = 2 \neq Order of the matrix (4)
So the solution is non optimal.

Improved Matrix (Non Optimal)

Jobs \ M/cs	A	B	C	D
I	0	2	5	8
II	0	0	1	2
III	0	0	1	2
IV	1	0	0	0

Here minimum no. of horizontal and vertical straight lines to cover all the zeros = 3 \neq Order of the matrix (4)
So the solution is non optimal.

Further Improved Matrix [Optimal Solution (i)]

Jobs \ M/cs	A	B	C	D
I	0	2	4	7
II	∞	0	∞	1
III	∞	∞	0	1
IV	2	1	∞	0

Here minimum no. of horizontal and vertical straight lines to cover all the zeros = 4 = Order of the matrix.
So the solution is optimal.

Further Improved Matrix (Optimal Solution-ii)

Jobs \ M/cs	A	B	C	D
I	0	2	4	7
II	∞	∞	0	1
III	∞	0	∞	1
IV	2	1	∞	0

Assignment as per Soution (i)			Assignment as per Soution (ii)		
Jobs	M/cs	Profit (₹)	Jobs	M/cs	Profit (₹)
I	A	42	I	A	42
II	B	25	II	C	20
III	C	20	III	B	25
IV	D	12	IV	D	12
Total	-	₹ 99	Total	-	₹ 99

Maximum Profit ₹ 99



4.4 SCHEDULING

Scheduling: 'Scheduling' is the next important function of production planning and control after 'Routing'. It determines the starting and the completion timings for each of the operations with a view to engage every machine and operator of the system for the maximum possible time and; without imposing unnecessary burden over them. Scheduling is the determination of the time that should be inquired to perform each operation and also the time that should be required to perform the entire series as routed. Scheduling involves establishing the amount of work to be done and the time when each element of the work will start or the order of the work.

Scheduling technique is an important technique of determining the starting and the completion timings of each operation and that of the total manufacturing process so that the man and machines can be utilised to the maximum.

Scheduling depends upon a number of factors, e.g., routing, the method of production, quantity of production, transportation of raw materials, production capacity, the probable data of delivery specified by customers in their orders and the past records.

Relationship between Routing and Scheduling: 'Routing' and 'Scheduling' are interconnected and either of these activities cannot be undertaken independently. It is very difficult to prepare schedules without determining the routing of sequence of operations. Routing is a prerequisite for scheduling while time to be taken 'may form the basis of routing and that is fixed by scheduling. Unless route or sequence of operations, tools, equipment and plants and the persons by when operations are to be performed, are established, the time taken by each operation, the idle time of men and machine and total time for the whole process cannot be ascertained in a convincing manner.

Conversely, scheduling is equally important for routing. It is quite difficult to route an item efficiently through a plant without consulting previously-designed schedules. The main aim of routing is to pass the item through the process of manufacture by a route which is the best and the most economical. And a route or sequence of operations may be considered best which utilises the men, materials and machines to the maximum and which consumes the shortest time during the process of production. This information (time schedule of each operation) can be obtained from schedules. So, scheduling is necessary for effective routing.

Thus, we can conclude that routing and scheduling are inter-related, inter-connected and inter-dependent activities of production planning and control.

Principles of Scheduling:

The principles of scheduling are:

- (a) **The principle of optimum task size:** Scheduling tends to achieve its maximum efficiency when the task sizes are small and all tasks are of the same order of magnitude.
- (b) **The principle of the optimum Production plan:** Scheduling tends to achieve its maximum efficiency when the work is planned, so that it imposes an equal/even load on all the plants/facilities.
- (c) **The principle of the optimum operation sequence:** Scheduling tends to achieve its maximum efficiency when the work is planned so that the work centers are normally used in the same sequence.

The first principle has a tendency when applied, not only give good results but also to be self-correcting if it is ignored. For example, if in a functional batch production machine shop the loads imposed by different operations vary greatly in length then it is possible that it will be necessary to break many of the long operations into one or more small batches, in order to get the other orders completed by due date. In effect, this principle only repeats the known advantage of maintaining a high rate of stock turn over, and of single phase ordering. The second principle merely states the obvious fact that there will be less idle time and waiting time, if all the plant is evenly loaded by the production planners, even if some of the machines are over loaded perhaps because of direct labour cost on them being lower and others are idle for part of the time due to shortage of work. The third principle says about principle of flow. Some times it is also true if we sequence some jobs, which need the same machine set



up, at a time, this avoids machine ancillary time needed, in case, the jobs of the above type are done at different times. For example, consider drilling a 10 mm hole in five different jobs may be done at a time so that the set up time required for five jobs can be reduced.

Forms of Schedules:

Here we shall discuss the presentation of production schedules. Depending on the need and use, the Schedules can be prepared in different forms.

A Production Flow Program:

If a number of components or assemblies have to be manufactured for the final assembly line and those components are to be made concurrently, the production master flow program is prepared taking into account the sequence of operations and the time of starting and ending of each component in order to comply with the required date of completion of the product. The necessary document for this is Operation Process Chart and the Sequence of Operation.

Scheduling Systems:

Scheduling Systems may be classified into various groups as shown below:

- (i) **Unit scheduling system:** This is used for scheduling when jobs are produced one by one and are of different types that is for job production.
- (ii) **Batch scheduling system:** When jobs are produced to order, in batches, this is used.
- (iii) **Mass scheduling system:** When large number of items of similar type are produced that is in mass production, this is used.

Unit Scheduling System:

Here we have two types of scheduling, one is Project scheduling and the other is Job Shop Scheduling.

Project Scheduling: Generally, a project consists of number of activities managed by different Apartments or individual supervisors. It can also be considered as a complex output made up of many interdependent activities. Examples are: Railway coach building, Shipbuilding etc. The scheduling methods used are:

- (i) Project Evaluation and Review Technique (PERT),
- (ii) Critical Path Method (CPM),
- (iii) Graphical Evaluation and Review Technique (GERT).

We can also use Bar charts, GANTT charts, Milestone chart, but these are less superior to the above.

Job Shop Scheduling: In Job shop scheduling, we come across varieties of jobs to be processed on different types of machines. Separate records are to be maintained for each order. Only after receiving the order, one has to plan for production of the job. The routing is to be specified only after taking the order. Scheduling is done to see that the available resources are used optimally. The following are some of the factors taken into consideration for job shop scheduling. (i) Arrival pattern of the job, (ii) Processing pattern of the job, (iii) Depending on the type of machine used, (iv) Number of workers available in the shop, (v) Order of sequencing.

Arrival pattern of the job: This is done in two ways. Firstly, as and when the order is received, it is processed on the principle of First in First Out (FIFO). Otherwise, if the orders are received from single customer at different points of time in a week/month, then the production manager pile up all the orders and starts production depending on the delivery date and convenience (This situation is generally known as static situation).

Processing Pattern of the Job: As the layout of Job shops is of Process type and there may be duplication of certain machines, the production planner, after receiving the order thinks of the various methods of converting the requirement of customer / order into a production plan to suit the available facilities. Depending on the process required, there may be backtracking, which is unavoidable. When facilities are busily engaged, in process



inventory may be a common problem.

Machine varieties available: Facilities available in the production shop will affect the scheduling. Here the size, capacity, precision and other factors of machines will have their influence on the scheduling.

Number of Men in the production shop: Many a time we see that the number of workers available in the job shops are very much limited, that is sometimes they are less in number than the machines in the shop (these shops are known as labour limited shop). Depending on the availability of labour, the scheduling is to be done. In case the machines available are limited and have more men (known as machine limited shops), then availability of machine dictates the scheduling.

Sequencing rules for single facility: When we have a single facility, and the orders are in queue, then they are processed depending on the rules mentioned below:

- (a) **First in first served or first in first out (FIFS/FIFO):** Here the jobs are processed as they come in. This commonly observes queue discipline.
- (b) **Shortest processing time (SPT):** The jobs having shortest processing time are processed first. This is just to avoid formation of queue. For example, when you go for Xeroxing a document, and other person comes for Xeroxing a book, then the document is Xeroxed first and subsequently the book is taken up for Xeroxing.
- (c) **Minimum due date (MDD):** Here jobs are processed in ascending order of their available time before delivery date. By doing so, we can keep up the delivery promises. To meet the delivery promises, if necessary, overtime, sub contracting etc., may be used.
- (d) **Last come first served or last in first out (LCFS/LIFO):** This generally happens in case of inventory stocking and using. When material piles up, the material at the top i.e., material last arrived is used first.
- (e) **Static slack for remaining operations (SSRO):** Static slack is given by: $(\text{Time till due date} - \text{Remaining processing time} / \text{number of remaining operations})$. Here jobs are processed in ascending order of the operations.
- (f) **Dynamic slack for remaining operations (DSRO):** Dynamic slack is given by: $(\text{Time till due date} - \text{expected time of remaining operations} / \text{number of remaining operations})$. Here the jobs are done in ascending order of the ratio dynamic slack.

Basic Scheduling Problems:

The production planner may face certain problems while preparing production plans or Schedules. Some important problems are discussed below:

- (a) Flow production scheduling for fluctuating demand (known smoothing problem),
- (b) Batch production scheduling, when products are manufactured consecutively,
- (c) The assignment problem,
- (d) Scheduling orders with random arrivals and
- (e) Product sequencing.

Illustration 6.

The processing times (t_j) in hrs for the five jobs of a single machine scheduling is given. Find the optimal sequence which will minimise the mean flow time and find the mean flow time.

Determine the sequence which will minimise the weighted mean flow time and also find the mean flow time

Job (j)	1	2	3	4	5
Processing time (t_j) hrs	30	8	10	28	16
Weight (W_j)	1	2	1	2	3

**Solution:**

(a) First arrange the jobs as per the shortest processing time (SPT) sequence.

Job (j)	2	3	5	4	1
Processing time (t_j) hrs	8	10	16	28	30

Therefore, the job sequence that minimises the mean flow time is 2-3-5-4-1.

Computation of minimum flow time (F min)

The flow time is the amount of time the job 'j' spends in the system. It is a measure which indicates the waiting of jobs in the system. It is the difference between the completion time (C_j) and ready time (R_j) for job j.

$$F_j = C_j - R_j$$

Job (j)	2	3	5	4	1
Processing time (t_j) hrs	8	10	16	28	30
Completion time (C_j)	8	18	34	62	92

Since the ready time (R_j) = 0 for all j, the flow time (\bar{F}) is equal to C_j for all j.

$$\text{Mean flow time} = (\bar{F}) = \frac{1}{n} \sum_{j=1}^n F_j = \frac{1}{5} [8 + 18 + 34 + 62 + 92] = \frac{1}{5} [214] = 42.8 \text{ hours}$$

(b) The weights are given as follows:

Job (j)	1	2	3	4	5
Processing time (t_j) hrs	30	8	10	28	16
Weight (W_j)	1	2	1	2	3

$$\text{The weighted processing time} = \frac{\text{Processing time } (t_j)}{\text{Weight } (W_j)}$$

The weighted processing time is represented as

Job (j)	1	2	3	4	5
Processing time (t_j) hrs	30	8	10	28	16
Weight (W_j)	1	2	1	2	3
Weighted Processing time (t_j/W_j)	30	4	10	14	5.31

Thus, arranging the jobs in the increasing order of t_j/W_j (weighted shortest processing time WSPT) we have

Job (j)	2	5	3	4	1
Weighted Processing time (t_j/W_j)	4	5.31	10	14	30

optimal sequence that minimises the weighted mean flow time is 2-5-3-4-1.



$$\text{Weighted Mean flow time } (\bar{F}_w): \bar{F}_w = \frac{\sum_{j=1}^n W_j F_j}{\sum_{j=1}^n W_j}$$

Job (j)	2	5	3	4	1
Processing time (t_j) hrs	8	16	10	28	30
$F_j = (C_j - R_j)$	8	24	34	62	92
W_j	2	3	1	2	1
$F_j \times W_j$	16	72	34	124	92

The weighted mean flow time is computed as follows for optimal sequence.

Weighted mean flow time (\bar{F}_w) is computed as

$$\bar{F}_w = \frac{(16 + 72 + 34 + 124 + 92)}{(2 + 3 + 1 + 2 + 1)} = 37.55 \text{ hrs.}$$

Elements of Scheduling

- (i) Demand forecasts/customer's firm orders-determine the delivery dates for finished products.
- (ii) Aggregate scheduling : Tentative schedule based on demand for quarterly or monthly requirements. Enables employment of available resources in meeting the demand by adjusting the capacity. Needs rough-cut capacity planning.
- (iii) Production plan : Showing output levels planned, resource requirements, and capacity limitations and inventory levels.
- (iv) Master production schedule : Dates committed and desired quantity to be produced on a daily, weekly, monthly or quarterly basis.
- (v) Priority planning : Master schedule is exploded into components and parts that are required to produce the product.
- (vi) Capacity planning: Regulates loading of specific jobs on specific work centres or machines for specific periods of time.
- (vii) Facility loading or machine loading: Loading work centres/Machines after deciding which job to be assigned to which work centre/machine i.e., actual assignment of jobs to machines taking into consideration priority sequencing and machine utilisation.
- (viii) Evaluation of workload : To balance the workload on various work centres /machines when resources are scarce or limited. Excess load in one work centre or machine has to be transferred to other work centre or machine having spare capacity.
- (ix) Sequencing : Priority sequencing of jobs is done to maximise workflow through work-centres or machines to minimise delay and cost of production.

4.5 QUEUING MODELS

General Structure of Queuing System

The general structure of a queuing system is depicted in Figure 4.5.1

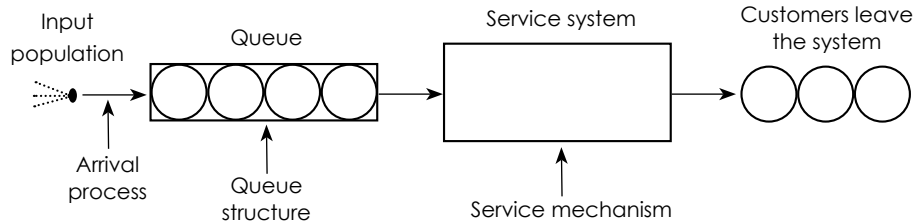

Fig. 4.5.1 General Structure of the Queuing System

We shall discuss in more details the various elements of a queuing system and then present mathematical results for some specific systems. The elements of a system are:

1. Arrival process:

The arrivals from the input population may be classified on different basis as follows:

- (a) **According to source:** The source of customers for a queuing system can be infinite or finite. For example, all people of a city or state (and others) could be the potential customers at a superbazar. The number of people being very large, it can be taken to be infinite. On the other hand, there are many situations in business and industrial conditions where we cannot consider the population to be infinite — it is finite. Thus, the ten machines in a factory requiring repairs and maintenance by the maintenance crew would exemplify finite population. Removing one machine from a small, finite, population like this will have a noticeable effect on the calls expected to be made (for repairing) by the remaining machines than if there are a large number of machines, say 500.
- (b) **According to numbers:** The customers may arrive for service individually or in groups. Single arrivals are illustrated by customers visiting a beautician, students reaching at a library counter, and so on. On the other hand, families visiting restaurants, ships discharging cargo at a dock are examples of bulk, or batch, arrivals.
- (c) **According to line:** Customers may arrive in the system at known (regular or otherwise) times, or they might arrive in a random way. The queuing models wherein customers' arrival times are known with certainty are categorized as deterministic models (insofar as this characteristic is concerned) and are easier to handle. On the other hand, a substantial majority of the queuing models are based on the premise that the customers enter the system stochastically, at random points in time.

With random arrivals, the number of customers reaching the system per unit time might be described by a probability distribution. Although the arrivals might follow any pattern, the frequently employed assumption, which adequately supports many real world situations, is that the arrivals follow Poisson distribution.

2. Service system:

There are two aspects of a service system—

- (a) structure of the service system, and
 - (b) the speed of service.
- (a) **Structure of the service system:** By structure of the service system we mean how the service facilities exist. There are several possibilities. For example, there may be
- (i) **A single service facility**
- A library counter is an example of this. The models that involve a single service facility are called single server models. **Figure 4.5.2(a)** illustrates such a model.

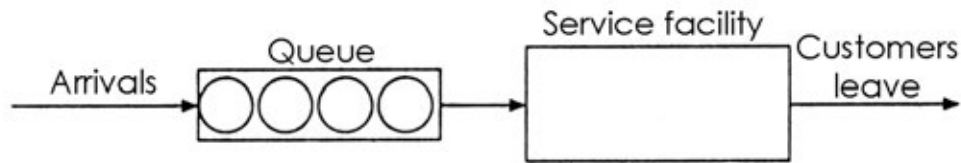

Fig. 4.5.2 (a): Single Server, Single Queue Model

(ii) Multiple, parallel facilities with single queue:

That indicates there is more than one server. The term parallel implies that each server provides the same type of facility. Booking at a service station that has several mechanics, each handling one vehicle, illustrates this type of model. It is shown in Figure 4.5.2 (b).

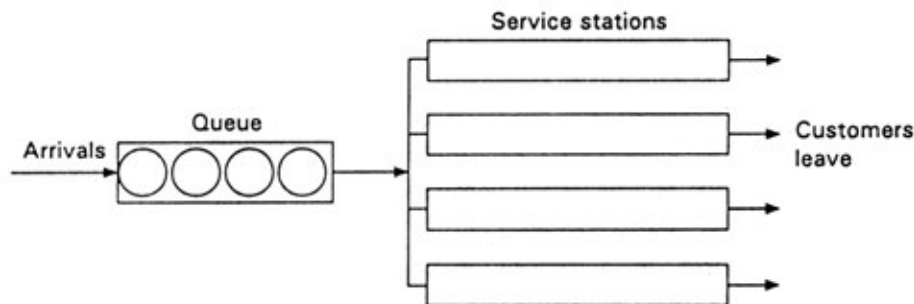

Fig. 4.5.2 (b): Multiple, Parallel Servers, Single Queue Model

(iii) Multiple, parallel facilities with multiple queues:

This type of model is different from the earlier one only in that each of the servers has a different queue. Different cash counters in an electricity office where the customers can make payment in respect of their electricity bills is an example of this type of model. Figure 4.5.2 (c) portrays such a model.

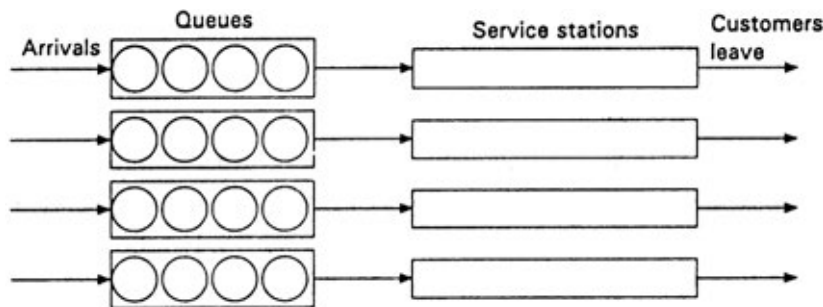

Fig. 4.5.2 (c): Multiple, Parallel Servers, Multiple Queues Model

(iv) Service facilities in a series:

In this, a customer enters the first station and gets a portion of service and then moves on to the next station, gets some service and then again moves on to the next station . . . and so on, and finally leaves the system, having received the complete service. For example, machining of a certain steel item may consist-of cutting, turning, knurling, drilling, grinding, and packaging operations, each of which is performed by a single server in a series. Figure 4.5.2 (d) shows such a situation.

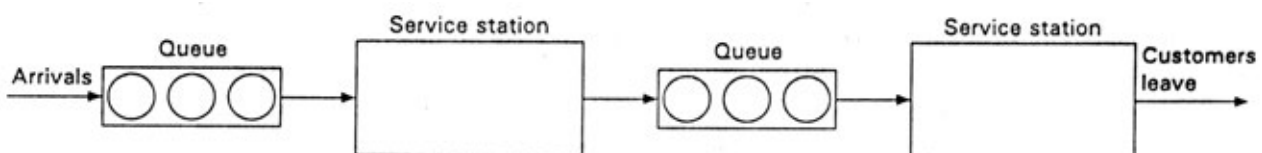

Fig. 4.5.2 (d): Multiple Servers in Series



Besides these, there may be other possibilities as well.

- (b) Speed of service:** In a queuing system, the speed with which service is provided can be expressed in either of two ways—as service rate and as service time. The service rate describes the number of customers serviced during a particular time period. The service time indicates the amount of time needed to service a customer. Service rates and times are reciprocals of each other and either of them is sufficient to indicate the capacity of the facility. Thus, if a cashier can attend, on the average, to 10 customers in an hour, the service rate would be expressed as 10 customers/hour and service time would be equal to 6 minutes/customer. Generally, however, we consider the service time only,

If these service times are known exactly, the problem can be handled easily. But, as generally happens, if these are different and not known with certainty, then we have to consider probabilities the distribution of the service times in order to analyse the queuing system. Generally, the queuing models are based on the assumption that service times are exponentially distributed about some average service time.

3. Queue structure:

Another element of a queuing system is the queue structure. In the queue structure, the important thing to know is the queue discipline which means the order by which customers are picked up from the waiting line for service. There are a number of possibilities. They are:

- (a) First-come-first-served:** When the order of service of customers is in the order of their arrival, the queue discipline is of the first-come-first-served type. For example, with a queue at the bus stop, the people who came first will board the bus first.
- (b) Last-come-first-served:** Sometimes, the customers are serviced in an order reverse of the order in which they enter so that the ones who join last are served first. For example, assume that letters to be typed, or order forms to be processed accumulate in a pile, with each new addition being put on the top of them. The typist or the clerk might process these letters or orders by taking each new task from the top of the pile. Thus, a just arriving task would be the next to be serviced provided that no fresh task arrives before it is picked up. Similarly, the people who join an elevator last are the first ones to leave it.
- (c) Service-in-random-order (SIRO):** Random order of service is defined as: whenever a customer is chosen for service, the selection is made in a way that every customer in the queue is equally likely to be selected. The time of arrival of the customers is, therefore, of no consequence in such a case.
- (d) Priority service:** The customers in a queue might be rendered service on a priority basis. Thus, customers may be called according to some identifiable characteristic (length of job, for example) for service. Treatment of VIPs in preference to other patients in a hospital is an example in point.

For the queuing models that we shall consider, the assumption would be that the customers are serviced on the first-come-first-served basis.

Another thing to consider in the queuing structure is the behaviour or attitude of the customers entering the queuing system. On this basis, the customers may be classified as being (a) patient or (b) impatient. If the customers join a queue, when it exists, and wait till they enter the service station for getting service they are called patient customers. On the other hand, the queuing systems may enjoy customer behaviour in the form of defections from the queue. The customers may not select queues randomly (if there are multiple queues) and look for the shortest queue. There may be jockeying among the many queues, that is the customers may switch to other queues which are moving 'fast', and also reneging is possible—when a customer stands in the queue for sometime and then leaves the system because it is working 'too slowly'. There may also be bribing or cheating by some customers for queue positions. Besides, some customers may, upon their arrival, not join the queue for some reason and decide to return for service at a later time, or may even abandon the input population altogether. In terms of the queuing theory, this is known as balking, and occurs particularly when there are limits on the time and the extent of storage capacity available to hold waiting customers. Unless otherwise specified, the storage capacity is taken to be infinite. In the queuing models that we consider, we shall assume that there is no balking or jockeying and that the customers leave the system only after receiving service, and not before. Mathematical models give way to simulation when this assumption breaks.

Operating Characteristics of Queuing System

An analysis of a given queuing system involves a study of its different operating characteristics. This is done using queuing models. Some of the more commonly considered characteristics are discussed below:

1. **Queue length**—the average number of customers in the queue waiting to get service. Large queues may indicate poor server performance while small queues may imply too much server capacity.
2. **System length**—the average number of customers in the system, those waiting to be and those being serviced. Large values of this statistic imply congestion and possible customer dissatisfaction and a potential need for greater service capacity,
3. **Waiting time in the queue**—the average time that a customer has to wait in the queue to get service. Long waiting times are directly related to customer dissatisfaction and potential loss of future revenues, while very small waiting times may indicate too much service capacity.
4. **Total time in the system**—the average time that a customer spends in the system, from entry in the queue to completion of service. Large values of this statistic are indicative of the need to make adjustment in the capacity.
5. **Server idle time**—the relative frequency with which the service system is idle. Idle time is directly related to cost. However, reducing idle time may have adverse effects on the other characteristics mentioned above.

We now proceed to discuss some of the queuing models. It may be mentioned here that the results obtained from various models are based on the assumption that the service system is operating under equilibrium or steady state conditions. For many systems, the operating day begins in transient state with no customers in the system. It takes some initial time interval for enough customers to arrive such that a steady state balance is reached. It should be clearly understood that a steady state does not mean that the system will reach a point where the number of customers in the system never changes. Even when the system reaches equilibrium, fluctuations will occur. A steady state condition really implies that various system performance measures (the operating characteristics) would reach stable values.

Characteristics of Waiting Lines

There are numerous queuing models from which an analyst can choose. Naturally, much of the success of the analysis will depend on choosing an appropriate model. Model choice is affected by the characteristics of the system under investigation. The main characteristics are—

1. Population source.
2. Number of servers (channels)
3. Arrival and service patterns.
4. Queue discipline (order of service).

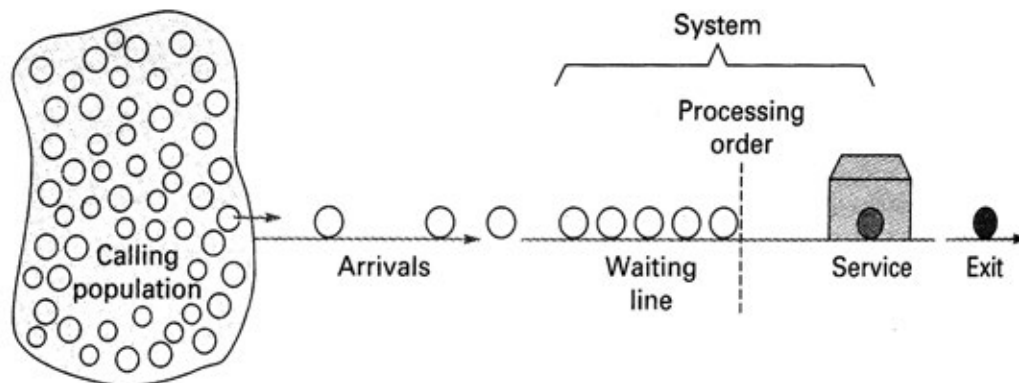

Fig 2.5.3: A simple queuing system

Population source

The approach to use in analyzing a queuing problem depends on whether the potential number of customers is limited. There are two possibilities: infinite-source and finite-source populations. In an infinite-source situation, the potential number of customers greatly exceeds system capacity. Infinite-source situations exist whenever service is unrestricted. Examples are supermarkets, drugstores, banks, restaurants, theaters, amusement centers, and toll bridges. Theoretically, large numbers of customers from the "calling population" can request service at any time. When the potential number of customers is limited, a finite-source situation exists. An example is the repairman responsible for a certain number of machines in a company. The potential number of machines that time cannot exceed the number of machines assigned to be repaired. Similarly, an operator may be responsible for loading and unloading a bank of four machines, a nurse may be responsible for answering patient calls for a 10-bed ward, a secretary may be responsible for taking dictation from three executives, and a company shop may perform repairs as needed on the firm's 20 trucks.

Number of servers (Channels)

Channel indicates a server in a service system: The capacity of queuing systems is a function of a capacity of each server and the number of servers being used. The terms server and channel are synonymous, and it is generally assumed that each channel can handle one customer at a time. Systems can be either single-or multiple-channel. (A group of servers working together as a team, such as a surgical team, is treated as a single-channel system.) Examples of single-channel systems are small grocery stores with one checkout counter, some theaters, single-bay car washes, and drive-in banks with one teller. Multiple-channel systems (those with more than one server) are commonly found in banks, at airline ticket counters, at auto service centers, and at petrol pumps.

A related distinction is the number of steps or phases in a queuing system. For example, at theme parks, people go from one attraction to another. Each attraction constitutes a separate phase where queues can (and usually do) form.

Figure 4.5.4 illustrates some of the most common queuing systems. Because it would not be possible to cover all of these cases in sufficient detail in the limited amount of space available here, our discussion will focus on single-phase systems.

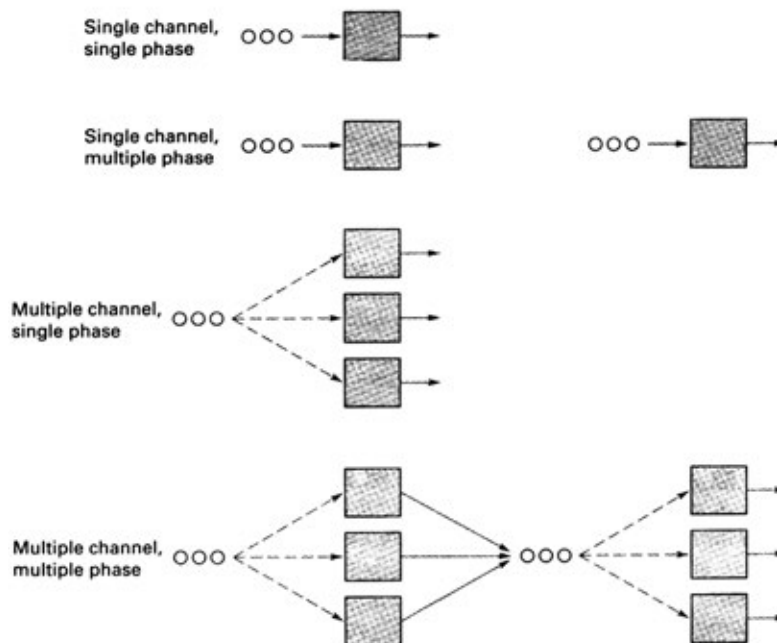

Fig. 4.5.4: Four common variations of queuing systems

Queue Discipline

Queue discipline refers to the order in which customers are processed. All but one of the models to be described shortly assume that service is provided on a first-come, first-served basis. This is perhaps the most commonly

encountered rule. There is first-come service at banks, stores, theaters, restaurants, four-way stop signs, registration lines, and so on. Examples of systems that do not serve on a first-come basis include hospital emergency rooms, rush orders in a factory, and main frame computer processing of jobs. In these and similar situations, customers do not all represent the same customer waiting costs; those with the highest costs (e.g., the most seriously ill) are processed first, even though other customers may have arrived earlier.

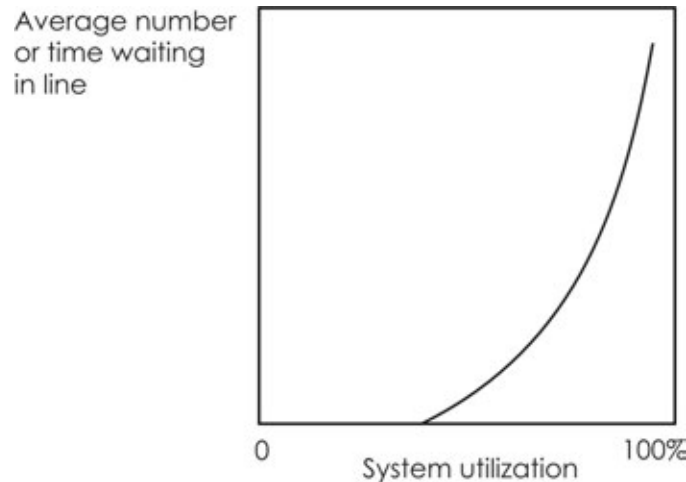

Fig. 4.5.5: The average number waiting in line and the average time customers wait in line increase exponentially as the system utilization increases

Measures of waiting-line performance

The operations manager typically looks at five measures when evaluating existing or proposed service systems. They relate to potential customer dissatisfaction and costs:

1. The average number of customers waiting, either in line or in the system.
2. The average time customers wait, either in line or in the system.
3. System utilization, which refers to the percentage of capacity utilized.
4. The implied cost of a given level of capacity and its related waiting line.
5. The probability that an arrival will have to wait for service.

Of these measures, system utilization bars some elaboration. It reflects the extent to which the servers are busy rather than idle. On the surface, it might seem that the operations manager would want to seek 100 percent utilization. However, as Figure 2.8.7 illustrates, increases in system utilization are achieved at the expense of increases in both the length of the waiting line and the average waiting time. In fact, these values become exceedingly large as utilization approaches 100 percent. The implication is that under normal circumstances, 100 per cent utilization is not a realistic goal. Even if it were, 100 per cent utilization of service personnel is not good; they need some slack time. Thus, instead, the operations manager should try to achieve a system that minimizes the sum of waiting costs and capacity costs.

Queuing Models: Infinite-source

Many queuing models are available for a manager or analyst to choose from. The discussion here includes four of the most basic and most widely used models. The purpose is to provide an exposure to a range of models rather than an extensive coverage of the field. All assume a Poisson arrival rate. Moreover, the models pertain to a system operating under steady-state conditions; that is, they assume the average arrival and service rates are stable. The four models described are

1. Single server, exponential service time.
2. Single server, constant service time.



3. Multiple servers, exponential service time.
4. Multiple priority service, exponential service time.

Note that the terms "server" and "channel" mean the same thing. To facilitate your use of waiting line models, **Table 4.5** provides a list of the symbols used for the infinite-source models.

Table 4.5 Infinite-source symbols

Symbol	Represents
λ	Customer arrival rate
μ	Service rate per server
L_a	The average number of customers waiting for service
L_s	The average number of customers in the system (waiting and/or being served)
r	The average number of customers being served
ρ	The system utilization
W_q	The average time customers wait in line
W_s	The average time customer's spend in the system (waiting in line and service time)
$1/\mu$	Service time
P_o	The probability of zero units in the system
P_n	The probability of n units in the system
M	The number of servers (channels)
L_{max}	The maximum expected number waiting in line

Basic Relationships

There are certain basic relationships that hold for all infinite-source models. Knowledge of these can be very helpful in deriving desired performance measures, given a few key values. Here are the basic relationships:

Note: The arrival and service rates, represented by λ and μ , must be in the same units (e.g., customers per hour, customers per minute).

(I) System utilization: This reflects the ratio of demand (as measured by the arrival rate) to supply or capacity (as measured by the product of the number of servers, M , and the service rate, μ).

$$\rho = \frac{\lambda}{M \times \mu}$$

(II) The average number of customers being served:

$$r = \frac{\lambda}{\mu}$$

For nearly all queuing systems, there is a relationship between the average time a unit spends in the system or queue and the average number of units in the system or queue. According to Little's law, for a stable system, the average number of customers in line or in the system is equal to the average customer arrival rate multiplied by the average time in line or the system. That is,

$$L_s = \lambda W_s \quad \text{and} \quad L_q = \lambda W_q$$

The implications of these are important in analysis of waiting lines. The relationships are independent of any probability distribution and require no assumptions about which customers arrive or are serviced, or the order in which they are served. It also means that knowledge of any two of the three variables can be used to obtain the third variable. For example, knowing the arrival rate and the average number in line, one can solve for the average waiting time.



Figure 4.5.6: Basic Relationships

	Line	+	Service	=	System
Customers \longrightarrow	000	\longrightarrow		\longrightarrow	
Average number waiting:	L_q	+		=	L_s
Average time waiting:		+		=	W_s

(III) The average number of customers

(A) Waiting in line or queue for service: L_q [Model dependent. Obtain using a table or formula.]

(B) Waiting In the system (line plus being served): $L_s = L_q + r$

(IV) The average time customers are

(A) Waiting in line or queue: $W_q = \frac{L_q}{\lambda}$

(B) Waiting in the system: $W_s = W_q + \frac{1}{\mu} = \frac{L_s}{\lambda}$

All infinite-source models require that system utilization be less than 1.0; the models apply only to underloaded systems.

The average number waiting in line, L_q , is a key value because it is a determinant of some of the other measures of system performance, such as the average number in the system, the average time in line, and the average time in the system. Hence, L_q will usually be one of the first values you will want to determine in problem solving.

Illustration 7.

Customers arrive at a bakery at an average rate of 16 per hour on weekday mornings. The arrival can be described by a Poisson distribution with a mean of 16. Each clerk can serve a customer in an average of three minutes; This time can be described by an exponential distribution with a mean of 3.0 minutes.

- What are the arrival and service rates?
- Compute the average number of customers being served at any time.
- Suppose it has been determined that the average number of customers waiting in line is 3.2. compute the average number of customers in the system (i.e., waiting in line or being served), the average time customers wait in line, and the average time in the system.
- Determine the system utilization for $M = 1, 2,$ and 3 servers.

Solution:

a. The arrival rate is given in the problem: $\lambda = 16$ customers per hour. Change the service time to a comparable hourly rate by first restating the time in hours and then taking its reciprocal. Thus, (3 minutes per customer)/(60 minutes per hour) = $1/20 = 1/\mu$. Its reciprocal is $\mu = 20$ customers per hour = Service Rate.

b. Average no. of customers being served at any time.

$$r = \frac{\lambda}{\mu} = \frac{16}{20} = 0.80 \text{ customer.}$$

Table 4.5.2: Formulas for basic single-server model

Performance Measure	Equation
Average number in line/queue	$L_q = \frac{\lambda^2}{\mu(\mu - \lambda)}$
Probability of zero units in the system	$P_0 = 1 - \left(\frac{\lambda}{\mu}\right)$
Probability of n units in the system	$P_n = P_0 \left(\frac{\lambda}{\mu}\right)^n$
Probability of less than n units in the system	$P_{<n} = 1 - \left(\frac{\lambda}{\mu}\right)^n$

c. Given: $L_q = 3.2$ customers

$$L_s = L_q + r = 3.2 + .80 = 4.0 \text{ customers}$$

Average time customers wait in line

$$= W_q = \frac{L_q}{\lambda} = \frac{3.2}{16} = 0.20 \text{ hour, or } 0.20 \text{ hour} \times 60 \text{ minutes/hour} = 12 \text{ minutes}$$

$$W_s = \text{Average time customers wait in system} = W_q + \frac{1}{\mu}$$

Waiting time in line plus service

$$= 0.20 + \frac{1}{20} = 0.25 \text{ hour, or } 15 \text{ minutes}$$

d. System utilization is $\rho = \frac{\lambda}{M \times \mu}$.

$$\text{For } M = 1, \rho = \frac{16}{1(20)} = 0.80$$

$$\text{For } M = 2, \rho = \frac{16}{2(20)} = 0.40$$

$$\text{For } M = 3, \rho = \frac{16}{3(20)} = 0.27$$

Note that as the system capacity is measured by $M\mu$ increases, the system utilization for a given arrival rate decreases.

Single server, exponential service time, M/M/1

The simplest model involves a system that has one server (or a single crew). The queue discipline is first-come, first-served, and it is assumed that the customer arrival rate can be approximate by a Poisson distribution and service time by a negative exponential distribution. There is no limit on length of queue.

Illustration 8.

An airline is planning to open a satellite ticket desk in a new shopping plaza, staffed by one ticket agent. It is estimated that requests for tickets and information will average 15 per hour, and requests will have a Poisson distribution. Service time is assumed to be exponentially distributed. Previous experience with similar satellite operations suggests that mean service time should average about three minutes per request.

Determine each of the following:

a. System utilization.



- b. Percentage of time the server (agent) will be idle.
- c. The expected number of customers waiting to be served.
- d. The average time customers will spend in the system.

The probability of zero customers in the system and the probability of four customers in the system.

Solution:

Arrival Rate = $\lambda = 15$ customers per hour

Service Rate = $\mu = \frac{1}{\text{Service time}} = \frac{1 \text{ customer}}{3 \text{ minutes}} \times 60 \text{ minutes per hour} = 20 \text{ customers per hour}$

a. System Utilisation = $\rho = \frac{\lambda}{M\mu} = \frac{15}{1(20)} = 0.75$

b. Percentage of time the server will be idle = $1 - \rho = 1 - 0.75 = 0.25$, or 25 percent

c. Expected no. of customers waiting to be served = $L_q = \frac{\lambda}{\mu(\mu - \lambda)} = \frac{225}{20(20 - 15)} = \frac{225}{(20 \times 5)} = \frac{225}{100} = 2.25 \text{ customers}$

d. Average time customers will spend in the system = $w_s = \frac{L_q}{\lambda} + \frac{1}{\mu} = \frac{2.25}{15} + \frac{1}{20} = 0.20 \text{ hours, or 12 minutes}$

e. Probability of zero customer in the system = $P_0 = 1 - \frac{\lambda}{\mu} = 1 - \frac{15}{20} = 0.25$ and

Probability of 4 customers in the system $P_4 = P_0 \left(\frac{\lambda}{\mu}\right)^4 = 0.25 \left(\frac{15}{20}\right)^4 = 0.079$

Single Server, Constant Service Time, M/D/1

As noted previously, waiting lines are a consequence of random, highly variable arrival and service rates. If a system can reduce or eliminate the variability of either or both, it can shorten waiting lines noticeably. A case in point is a system with constant service time. The effect of a constant service time is to cut in half the average number of customers waiting in line:

$$L_q = \frac{\lambda^2}{2\mu(\mu - \lambda)}$$

The average time customers spend waiting in line is also cut in half. Similar improvements can be realized by smoothing arrival times (e.g., by use of appointments).

Illustration 9.

Wanda's Car Wash & dry is an automatic, five-minute operation with a single bay. On a typical Saturday morning, cars arrive at a mean rate of eight per hour, with arrivals tending to follow a Poisson distribution. Find

- a. The average number of cars in line.
- b. The average time cars spend in line and service.

Solution:

Arrive Rate = $\lambda = 8$ cars per hour

Service Rate = $\mu = 1$ per 5 minutes, or 12 per hour

Av. no. of cars waiting in line = $L_q = \frac{\lambda^2}{2\mu(\mu - \lambda)} = \frac{8^2}{2(12)(12 - 8)} = 0.667 \text{ car}$

Av. time cars spend in line and service = $w_s = \frac{L_q}{\lambda} + \frac{1}{\mu} = \frac{0.667}{8} + \frac{1}{12} = 0.167 \text{ hours, or 10 minutes}$

**Illustration 10.**

A departmental store has one cashier. During the rush hours, customers arrive at a rate of 20 per hour. The average number of customers that can be handled by the cashier is 24 per hour. Assume the conditions for use of the single – channel queuing model. Find out average time a customer spends in the system.

Answer :

The usual notations are given:

Arrival Rate = $\lambda = 20$ customers / hour and service rate = $\mu = 24$ customers / hour

Average no. of customers in the system = $L_s = \frac{\lambda}{\mu - \lambda} = \frac{20}{24 - 20} = \frac{20}{4} = 5$ customers

Average time a customer spends in the system = $W_s = \frac{L_s}{\lambda} = \frac{5}{20} = \frac{1}{4} = 0.25$ hour = 15 mins.

Illustration 11.

As a tool service centre the arrival rate is two per hour and the service potential is three per hour. Simple queue conditions exist.

The hourly wage paid to the attendant at the service centre is ₹1.50 per hour and the hourly cost of a machinist away from his work is ₹ 4.

Calculate:

- (i) The average number of machinists being served or waiting to be served at any given time.
- (ii) The average time a machinist spends waiting for service.
- (iii) The total cost of operating the system for an eight – hour day.
- (iv) The cost of the system if there were two attendants working together as a team, each paid ₹ 1.50 per hour and each able to service on average 2 per hour.

Answer:

Arrival rate = $\lambda = 2$ per hour

Service rate = $\mu = 3$ per hour

- (i) Average number of machinists being served or waiting to be served at any given time:

$$L_s = \frac{\lambda}{\mu - \lambda} = \frac{2}{3 - 2} = 2$$

- (ii) Average Time a machinist spends waiting for the services:

$$W_q = \frac{\lambda}{\mu} \times \frac{1}{(\mu - \lambda)} = \frac{2}{3} \times \frac{1}{(3 - 2)} = 0.667 \text{ hours}$$

It means a machinist spends 40 minutes (ie., 60×0.667) in the queue.

- (iii) Average time in the system

$$W_s = \frac{1}{(\mu - \lambda)} = \frac{1}{(3 - 2)} = 1 \text{ hour}$$

Average number of machinists in the system = 2 [As per (i) above]

Cost of two machinists being away from work = ₹ 4 x 2 = ₹8.00 per hour

Attendant cost =

1.50 per hour
9.50 per hour

Cost of 8- hour day = 8 hrs x ₹9.50 = ₹76.00



(iv) It is assumed that there is still a single service point, but the average service rate with 2 attendants now is 4 per hour

∴ Now $\lambda = 2$ per hour

$\mu = 4$ per hour

∴ Average number of machinists in the system = $L_s = \frac{\lambda}{\mu - \lambda} = \frac{2}{4 - 2} = 1$

Average time spent by a machinist in the system = $W_s = \frac{1}{\mu - \lambda} = \frac{1}{4 - 2} = \frac{1}{2}$ hour

Machinists cost = $\frac{1}{2}$ hr \times ₹4 =	₹ 2.00
Attendant cost (@ 1.50 per attendant \times 2 attendants)	₹ 3.00
Total Cost	₹ 5.00

Cost per 8 – hour day = ₹5 \times 8 hrs. = ₹40.00

Illustration 12.

Workers come to tool store room to enquire about special tools (required by them) for accomplishing a particular project assigned to them. The average time between two arrivals is 60 seconds and the arrivals are assumed to be in Poisson distribution. The average service time (of the tool room attendant) is 40 seconds.

Determine:

- (i) average queue length,
- (ii) average length of non-empty queues,
- (iii) average number of workers in system including the worker being attended
- (iv) mean waiting time of an arrival,
- (v) average waiting time of an arrival who waits.

Answer:

Here, Arrival Rate = $\lambda = \frac{60}{60}$ per second = 1 per minute

Service Rate = $\mu = \frac{60}{40}$ per second = 1.5 per minute

(i) Average queue length:

$$L_q = \frac{\lambda}{\mu} \times \frac{\lambda}{\mu - \lambda} = \frac{1}{1.5} \times \frac{1}{1.5 - 1} = \frac{1}{0.75} = \frac{4}{3} \text{ workers}$$

(ii) Average length of non-empty queues:

$$L_n = \frac{\mu}{\mu - \lambda} = \frac{1}{1.5 - 1} = 3 \text{ workers}$$

(iii) Average number of workers in the system:

$$L_s = \frac{\lambda}{\mu - \lambda} = \frac{1}{1.5 - 1} = 2 \text{ workers}$$

(iv) Mean waiting time of an arrival

$$W_q = \frac{\lambda}{\mu} \times \left(\frac{\lambda}{\mu - \lambda} \right) = \frac{1}{1.5} \times \left(\frac{1}{1.5 - 1} \right) = \frac{3}{4} \text{ minutes}$$

(v) Average waiting time of an arrival who waits

$$W_n = \frac{1}{\mu - \lambda} = \frac{1}{1.5 - 1} = 2 \text{ minutes}$$

**4.6 SIMULATION**

The techniques of LPP, Transportation, and Assignment are used for optimization of various types of problem faced in business situations. However, all the business situations can not be solved with the above techniques only. There may be some complex situations, where numbers of assumptions are also necessary. It may be quite often possible to simulate the given system and study the behavior.

To simulate means to imitate. In general, simulation involves developing a model of real phenomenon and then performing experiments on the model evolved. It is to be noted that it is a descriptive and not optimizing technique. In simulation, a given system is copied and the variables and constants associated with it are manipulated in that artificial environment to examine the behavior of the system. For ex: aerodynamic testing, scaled down models of airplanes and placing them in work tunnels etc.

Thus, also in a complex situation of business a given system is taken and simulated for obtaining the required results.

It consists of four phases:

1. Definition of the problem and statement of objectives.
2. Construction of an appropriate model
3. Experimentation with the model constructed.
4. Evaluation of the results of simulation.

Monte Carlo Simulation:

Although simulation can be of many types, our discussion will focus on the probabilistic simulation using the Monte Carlo method. Also called computer simulation, it can be described as a numerical technique that involves modelling a stochastic system with objective of predicting the system's behaviours. The chance element is a very significant feature of Monte Carlo simulation and this approach can be used when the given process has a random, or chance, component.

In using the Monte Carlo method, a given problem is solved by simulating the original data with random number generators. Basically, its use requires two things, first, as mentioned earlier, we must have a model, that represents an image of the reality of the situation. Here the model refers to the probability distribution of the variable in question. What is significant here is that the variable may not be known to explicitly follow any of the theoretical distribution like Poisson, Normal and so on. The distribution may be obtained by direct observation or from past records. To illustrate, suppose, that a bakery keeps a record of the sale of the number of cakes of a certain type and the information relating to sales of 200 days is as below –

Demand (No of cakes):	5	6	7	8	9	10	11	12	total
(No of days) :	4	10	16	50	62	38	12	8	200

Illustration 13.

State the major two reasons for using simulation to solve a problem

A confectioner sells confectionery items. Past data of demand per week in hundred kilograms with frequency is given below:

Demand/Week	0	5	10	15	20	25
Frequency	2	11	8	21	5	3

Using the following sequence of random numbers, generate the demand for the next 10 weeks. Also find out the average demand per week.

Random numbers	35	52	13	90	23	73	34	57
	35	83	94	56	67	66	60	



Solution:

Table - I

Random No. Range Table for demand				
Demand per week	Frequency (f)	Probability (p = f ÷ ∑f)	Cumulative Probability	Range [†] of Random Nos.
0	2	.04	.04	00-03
5	11	.22	.26	04-25
10	8	.16	.42	26-41
15	21	.42	.84	42-83
20	5	.10	.94	84-93
25	3	.06	1.00	94-99
	∑f = 50	1.00		

†As the given Random Nos. are of 2 digits, the ranges of Random Nos. has also been considered to have 2 digits only. Also the range of Random Nos. corresponds to cumulative probability values which lies between 0 & 1 and can be correlated as nos. between 00 and 99.

Table - II

Simulated Values for next 10 weeks		
Weeks	Random Nos.	Demand
1	35*	10*
2	52	15
3	13	5
4	90	20
5	23	5
6	73	15
7	34	10
8	57	15
9	35	10
10	83	15
Total	–	120

*From Table (I), Random No. 35 appears in the range of 26-41. Also the demand for this range is 10.

Average weekly demand = $\frac{120}{10} = 12$

Illustration 14.

The manager of a book store has to decide the number of copies of a particular tax law book to order. A book costs ₹ 60 and is sold for ₹ 80. Since some of the tax laws change year after year, any copies unsold while the edition is not current must be sold for ₹ 30. From past records, the distribution of demand for this book has been obtained as follows:

Demand (No of copies)	15	16	17	18	19	20	21	22
Proportion	0.05	0.08	0.20	0.45	0.10	0.07	0.03	0.02

Using the following sequence of random numbers, generate the demand for 20 time periods(years). Calculate the average profit obtainable under each of the courses of action open to the manager. What is the optimal policy?

14	02	93	99	18	71	37	30	12	10
88	13	00	57	69	32	18	08	92	73



Solution:

Random No. Range Table			
Demand	Probability	Cumulative Probability	Random No. Range
15	.05	.05	00-04
16	.08	.13	5-12
17	.20	.33	13-32
18	.45	.78	33-77
19	.10	.88	78-87
20	.07	.95	88-94
21	.03	.98	95-97
22	.02	1.00	98-99
Total	1.00	-	-

Calculation of demand and profit for next 20 years					
Year	Random Numbers	Expected demand	No. of books unsold if stock is		
			16*	17*	18*
1	14	17	-	-	1
2	02	15	1	2	3
3	93	20	-	-	-
4	99	22	-	-	-
5	18	17	-	-	1
6	71	18	-	-	-
7	37	18	-	-	-
8	30	17	-	-	1
9	12	16	-	1	2
10	10	16	-	1	2
11	88	20	-	-	-
12	13	17	-	-	1
13	00	15	1	2	3
14	57	18	-	-	-
15	69	18	-	-	-
16	32	17	-	-	1
17	18	17	-	-	1
18	08	16	-	1	2
19	92	20	-	-	-
20	73	18	-	-	-
Total			2	7	18

*Looking at the simulated demand pattern, these stock figures have been chosen to find out optimal course of action. Stock figures of 20 or more have not been considered because it is quite obvious that such figures will not give optimal course of action due to high losses for the unsold books.



Statement Showing Computation of Profit			
No. of Books order (n)	No. of Books sold in 20 years (n × 20 - Books unsold)	*Net Profit (₹)	Average Profit/Year (Profit ÷ 20)
15	15 × 20 = 300	₹ 6000	₹ 300
16	16 × 20 - 2 = 318	₹ 6300 (318 × 20) - 2 × 30	₹ 315
17	(17 × 20) - 7 = 333	₹ 6450 (333 × 20) - 7 × 30	₹ 322.5
18	(18 × 20) - 18	₹ 6300 (342 × 20) - 18 × 30	₹ 315

* Net Profit = No. of books sold × ₹ 20# - No. of books unsold × ₹ 30°

Selling price/book = ₹ 80, Cost/book = ₹ 60

Profit /book = 80 - 60 = ₹ 20

Selling price of any unsold book = ₹ 30

°Loss incurred/unsold book = ₹ 60 - ₹ 30 = ₹ 30

Since profit is maximum for 17 books order, the optimal policy is to order 17 books per year.

Illustration 15.

A Small retailer has studied the weekly receipts and payments over the past 200 weeks and has developed the following set of information:

Weekly Receipts (₹)	Probability	Weekly Payments (₹)	Probability
3000	0.20	4000	0.30
5000	0.30	6000	0.40
7000	0.40	8000	0.20
12000	0.10	10000	0.10

Using the following set of random numbers, simulate the weekly pattern of receipts and payments for the 12 weeks of the next quarter, assuming further that the beginning bank balance is ₹ 8000. What is the estimated balance at the end of the 12 weekly period? What is the highest weekly balance during the quarter? What is the average weekly balance for the quarter?

Random Numbers

For Receipts	03	91	38	55	17	46	32	43	69	72	24	22
For payments	61	96	30	32	03	88	48	28	88	18	71	99

According to the given information, the random number interval is assigned to both the receipts and the payments.

**Solution:**

Range of random numbers							
Receipt (₹)	Probability	Cumulative probability	Range	Payments (₹)	Probability	Cumulative probability	Range
3000	0.20	0.20	00-19	4000	0.30	0.30	00-29
5000	0.30	0.50	20-49	6000	0.40	0.70	30-69
7000	0.40	0.90	50-89	8000	0.20	0.90	70-89
12000	0.10	1.00	90-99	10000	0.10	1.00	90-99

Simulation of Data for a period of 12 weeks					
Week	Random No. for receipt	Expected Receipt (₹)	Random No. for payment	Expected Payment (₹)	Week end Balance (₹)
Opening Balance					8000
1	03	3000	61	6000	5000 (8000 + 3000 - 6000)
2	91	12000	96	10000	7000
3	38	5000	30	6000	6000
4	55	7000	32	6000	7000
5	17	3000	03	4000	6000
6	46	5000	88	8000	3000
7	32	5000	48	6000	2000
8	43	5000	28	4000	3000
9	69	7000	88	8000	2000
10	72	7000	18	4000	5000
11	24	5000	71	8000	2000
12	22	5000	99	10000	(3000)

Estimated balance at the end of 12th week = ₹ (3,000)

Highest balance = ₹ 7,000

Average balance during the quarter = $45,000/12 = ₹ 3,750$

**Illustration 16.**

An automobile production line turns out about 100 cars a day, but deviations occur owing to many causes. The production is more accurately described by the probability distribution given below:

Production/Day	Prob.	Production/Day	Prob.
95	0.03	101	0.15
96	0.05	102	0.10
97	0.07	103	0.07
98	0.10	104	0.05
99	0.15	105	0.03
100	0.20		
		Total	1.00

Finished cars are transported across the bay, at the end of each day, by ferry. If the ferry has space for only 101 cars, what will be the average number of cars waiting to be shipped, and what will be the average number of empty space on the boat? Use following Random Numbers to simulate the data provided above - 20, 63, 46, 16, 45, 41, 44, 66, 87, 26, 78, 40, 29, 92, 21.

Solution:

Simulation of data of an Automobile Production line			
Production/day	Probability	Cumulative Probability	Random No. Range
95	0.03	0.03	00-02
96	0.05	0.08	03-07
97	0.07	0.15	08-14
98	0.10	0.25	15-24
99	0.15	0.40	25-39
100	0.20	0.60	40-59
101	0.15	0.75	60-74
102	0.10	0.85	75-84
103	0.07	0.92	85-91
104	0.05	0.97	92-96
105	0.03	1.00	97-99
	1.00		



Simulated data				
Day	Random No.	Production	No. of cars waiting to be shipped	No. of empty space on the boat
1	20	98	-	3
2	63	101	-	-
3	46	100	-	1
4	16	98	-	3
5	45	100	-	1
6	41	100	-	1
7	44	100	-	1
8	66	101	-	-
9	87	103	2	-
10	26	99	-	2
11	78	102	1	-
12	40	100	-	1
13	29	99	-	2
14	92	104	3	-
15	21	98	-	3
Total			6	18

Average no. of cars waiting to be shipped = $6/15 = 0.40$ per day

Average no. of empty space on the boat = $18/15 = 1.2$ per day

Illustration 17.

A book store wishes to carry 'Ramayana' in stock. Demand is probabilistic and replenishment of stock takes 2 days (i.e. if an order is placed on March 1, it will be delivered at the end of the day on March 3). The probabilities of demand are given below:

Demand (daily)	0	1	2	3	4
Probability	0.05	0.10	0.30	0.45	0.10

Each time an order is placed, the store incurs an ordering cost of ₹ 10 per order. The store also incurs a carrying cost of ₹ 0.50 per book per day. The inventory carrying cost is calculated on the basis of stock at the end of each day.

The manager of the bookstore wishes to compare two options for his inventory decision.

- A. Order 5 books when the inventory at the beginning of the day plus order outstanding is less than 8 books.
- B. Order 8 books when the inventory at the beginning of the day plus order outstanding is less than 8.

Currently (beginning 1st day) the store has a stock of 8 books plus 6 books ordered two days ago and expected to arrive next day.

Using Monte-Carlo Simulation for 10 cycles, recommend, which option the manager, should choose.

The two digit random numbers are given below:

89	34	70	63	61	81	39	16	13	73
----	----	----	----	----	----	----	----	----	----

**Solution:**

Demand	Probability	Cumulative Probability	Random No. Range
0	0.05	0.05	00-04
1	0.10	0.15	05-14
2	0.30	0.45	15-44
3	0.45	0.90	45-89
4	0.10	1.00	90-99

Option - A

Day	Random No.	Demand	Opening Stock	Ordered Quantity receipt	Closing Stock	Quantity for which Order Placed
1	89	3	8	-	5	-
2	34	2	5	6	9	-
3	70	3	9	-	6	0
4	63	3	6	-	3	5
5	61	3	3	0	0	-
6	81	3	0	5	2	5
7	39	2	2	-	0	5
8	16	2	0	5	3	-
9	13	1	3	5	7	-
10	73	3	7	-	4	5
					39	

Ordering cost 4×10	₹ 40
Carrying cost 0.5×39	₹ 19.50
Total Cost	₹ 59.50

Option B

Day	R No.	Demand	Opening Stock	Ordered Quantity receipt	Closing Stock	Quantity for which Order placed
1	89	3	8	-	5	-
2	34	2	5	6	9	-
3	70	3	9	-	6	-
4	63	3	6	-	3	8
5	61	3	3	-	0	-
6	81	3	0	8	5	-
7	39	2	5	-	3	8
8	16	2	3	-	1	-
9	13	1	1	8	8	-
10	73	3	8	-	5	-
					45	



Ordering cost 2×10	₹ 20.0
Carrying cost 0.5×45	₹ 22.50
Total Cost	₹ 42.50

Option 'B' is better because it has low Inventory cost.

Illustration 18.

After observing heavy congestion of customers over a period of time in a petrol station, Mr. Petro has decided to set up a petrol pump facility on his own in a nearby site. He has compiled statistics relating to the potential customer arrival pattern and service pattern as given below. He has also decided to evaluate the operations by using the simulation technique.

Arrivals		Services	
Inter-arrival time (minutes)	Probability	Service time (minutes)	Probability
2	0.22	4	0.28
4	0.30	6	0.40
6	0.24	8	0.22
8	0.14	10	0.10
10	0.10		

Assume:

- (i) The clock starts at 8:00 hours
- (ii) Only one pump is set up.
- (iii) The following 12 Random Numbers are to be used to depict the customer arrival pattern:
78, 26, 94, 08, 46, 63, 18, 35, 59, 12, 97 and 82.
- (iv) The following 12 Random Numbers are to be used to depict the service pattern:
44, 21, 73, 96, 63, 35, 57, 31, 84, 24, 05, 37

You are required to find out the

- (i) probability of the pump being idle, and
- (ii) Average time spent by a customer waiting in queue.

Solution:

Inter-arrival time				Service time			
Minutes	Probability	Cumulative probability	Range of Random No.	Minutes	Probability	Cumulative probability	Range
2	0.22	0.22	00-21	4	0.28	0.28	00-27
4	0.30	0.52	22-51	6	0.40	0.68	28-67
6	0.24	0.76	52-75	8	0.22	0.90	68-89
8	0.14	0.90	76-89	10	0.10	1.00	90-99
10	0.10	1.00	90 - 99	-	-	-	-



Sl. No.	Random No. for inter arrival time	Inter arrival time (Mins.)	Entry time in queue as per clock	Service start time as per clock	Random no for service time	Service time (Mins.)	Service end time as per clock	Waiting time of customer (Mins.)	Idle time (Mins.)
1	78	8	8.08	8.08	44	6	8.14	-	8
2	26	4	8.12	8.14	21	4	8.18	2	-
3	94	10	8.22	8.22	73	8	8.30	-	4
4	08	2	8.24	8.30	96	10	8.40	6	-
5	46	4	8.28	8.40	63	6	8.46	12	-
6	63	6	8.34	8.46	35	6	8.52	12	-
7	18	2	8.36	8.52	57	6	8.58	16	-
8	35	4	8.40	8.58	31	6	9.04	18	-
9	59	6	8.46	9.04	84	8	9.12	18	-
10	12	2	8.48	9.12	24	4	9.16	34	-
11	97	10	8.58	9.16	05	4	9.20	18	-
12	82	8	9.06	9.20	37	6	9.26	14	-
Total Time								140	12

Average time spent by the customer waiting in the queue = $140/12 = 11.67$ minutes

Probability of idle time of petrol station = $\frac{\text{Total Idle time}}{\text{Total Operating time of the Service Channel}} = \frac{12}{86} = 0.1395$

time of the Service Channel*

* Service End Time - 9.26 Hrs. Service Channel opened at 8.00 hrs. i.e. Total Time of the Service Channel = 1 hr. 26 Mins = 86 Mins.

Illustration 19.

A retailer deals in a perishable commodity. The daily demand and supply are variables. The data for the past 500 days show the following demand and supply:

Availability (Kg.)	Supply (No. of days)	Demand (Kg.)	Demand (No. of days)
10	40	10	50
20	50	20	110
30	190	30	200
40	150	40	100
50	70	50	40

The retailer buys the commodity at ₹ 20 per kg. and sells at ₹ 30 per kg. Any commodity remains at the end of the day, has no sales value. Moreover the loss on unsatisfied demand is ₹ 8 per Kg. Given the following pair of random numbers, simulate 6 days sales, demand and profit: (31, 18) (63, 84) (15, 79) (07, 32) (43, 75) (81, 27). The first random number in the pair is that of supply and the second random number is for demand.



Answer:

Table-1: Probability Distribution (Supply)

Supply	Probability	Cum. Prob.	Range	Range of Random Nos. for simulation
10	$40/500 = 0.08$	0.08	0 - 0.08	00 - 07
20	$50/500 = 0.10$	0.18	0.08 - 0.18	08 - 17
30	$190/500 = 0.38$	0.56	0.18 - 0.56	18 - 55
40	$150/500 = 0.30$	0.86	0.56 - 0.86	56 - 85
50	$70/500 = 0.14$	1.00	0.86 - 1.00	86 - 99

Table-2: Probability distribution (Demand)

Demand	Probability	Cum. Prob.	Range	Range of Random Nos. for simulation
10	$50/500 = 0.10$	0.10	0 - 0.10	00 - 09
20	$110/500 = 0.22$	0.32	0.10 - 0.32	10 - 31
30	$200/500 = 0.40$	0.72	0.32 - 0.72	32 - 71
40	$100/500 = 0.20$	0.92	0.72 - 0.92	72 - 91
50	$40/500 = 0.08$	1.00	0.92 - 1.00	92 - 99

Table-3: Showing simulated data

Simulated data for supply			Simulated data for demand		
Day	Random No.	Supply (Kg.)	Day	Random No.	Demand (Kg.)
1	31	30	1	18	20
2	63	40	2	84	40
3	15	20	3	79	40
4	07	10	4	32	30
5	43	30	5	75	40
6	81	40	6	27	20

Table-4: Statement Showing Supply, Demand and Profit

Day	Supply	Demand	*Sales Revenue	Cost (II)	Loss due to unsatisfied demand (III)	Profit (₹)
(a)	(b)	(c)	(d)	(e) = (b) × ₹20/kg	(f) = [(c)-(b)] × ₹8/kg	(g) = (d)-(c)-(f)
1	30	20	600	600	-	Nil
2	40	40	1,200	800	-	400
3	20	40	600	400	160	40
4	10	30	300	200	160	-60**
5	30	40	900	600	80	220
6	40	20	600	800	-	-200**

* (1) Sales revenue = Demand × Selling price, when Demand < Supply

(2) Sales revenue = Supply × Selling price, when Demand > Supply

** Negative figures indicate loss



4.7 LINE BALANCING

Line balancing is arranging a production line so that there is an even flow of production from one work station to the next, i.e. so that there are no delays at any work station that will leave the next work station with idle time.

Line balancing is also defined as “the apportionment of sequential work activities into work stations in order to gain a high utilization of labour and equipment and therefore minimize idle time.” Balancing may be achieved by rearrangement of the work stations or by adding machines and / or workers at some of the stations so that all operations take about the same amount of time.

Line Balancing Procedure in Assembly Layouts

- Step 1 : Determine what tasks must be performed to complete one unit of a finished product and the sequence in which the tasks must be performed. Draw the precedence diagram.
- Step 2 : Estimate the task time (amount of time it takes a worker or a worker/machine combination to perform each task).
- Step 3 : Determine the cycle time (the amount of time that would elapse between products coming off the end of the assembly line if the desired hourly production rate is met.)
- Step 4 : Assign each task to a worker and balance the assembly line. This process results in determining the scope of each worker's job or which tasks that he or she will perform.

Steps Involved in Combining of the Tasks into Worker's Jobs

1. Starting at the beginning of the precedence diagram, combine tasks into a work station in the order of the sequence of tasks so that the combined task times approach but do not exceed the cycle time or multiples of the cycle time.
2. When tasks are combined into a workstation, the number of multiples of the cycle time is the number of workers required at the work station, all performing the same job.

Analysis of Line Balancing Problems

The procedure involves the following steps

1. Determine the no. of work stations and time available at each work station.
2. Group the individual tasks into amounts of work at each work station.
3. Evaluate the efficiency of grouping

When the available work time at any station exceeds that which can be done by one worker, additional workers must be added at that work station.

The key to efficient line balancing is to group activities or tasks in such a way that the work times at the work station are at or slightly less than the cycle time or a multiple of cycle time if more than one worker is required in any workstation.

Determination of cycle time (CT) : When the amount of output units required per period (period may be hour, shift, day or week etc.) is specified and the available time per period is given (i.e., the number of working hours per shift, number of shifts per day, number of working days per week etc.) then,

$$\text{Cycle time (CT)} = \frac{\text{Available time per period}}{\text{Output units required per period}}$$

Cycle time is the time interval at which completed products leave the production line.

Determination of the Ideal or Theoretical Minimum Number of Workers Required in the Line

$$\left. \begin{array}{l} \text{Ideal or theoretical} \\ \text{minimum no. of workers} \\ \text{required in the assy.} \\ \text{line/production line} \end{array} \right\} = \frac{\left(\begin{array}{l} \text{Total operation} \\ \text{or task time} \end{array} \right) \times \left(\begin{array}{l} \text{Output units} \\ \text{required per period} \end{array} \right)}{\text{Available time per period per worker}}$$

$$N = \sum t \times \left(\frac{1}{CT} \right) = \frac{\sum t}{CT}$$



Balancing Efficiency : An efficient line balancing will minimize the amount of idle time. The balance efficiency can be calculated as:

$$(i) \quad E_{\text{fFB}} = \frac{\text{Output of task time}}{\text{Input by workstation times}} = \frac{\sum t}{CT \times N}$$

Where, $\sum t$ = Sum of the actual worker times or task times to complete one unit

CT = Cycle time ; N = No. workers or work stations

$$(ii) \quad E_{\text{fFB}} = \frac{\text{Theoretical minimum number of workers}}{\text{Actual number of workers}}$$

The grouping of tasks is done with the aid of a precedence diagram. The precedence diagram is divided into work zones or stations and the appropriate activities are granted under each workstation until the cycle time is as fully utilized as possible.

Terminology Used in Line Balancing

- (i) Tasks : Element of work or activity
- (ii) Task precedence : Indicates the sequence in which tasks must be performed. Except the beginning task, all other tasks have preceding tasks.
- (iii) Task times : The amount of time required for an automatic machine or a well trained worker to perform a task.
- (iv) Cycle time : The interval of time between two successive products coming off the end of a production line or assembly line.
- (v) Productive time per hour : The duration (in minutes) a work station or machine is working in each-hour. The productive time per hour is lesser than the actual available time due to lunch break, breakdown, personal time for the worker, start-ups and shutdowns.
- (vi) Work station : Physical location where a particular set of tasks is performed. Workstation could be either a machine or equipment operated by a worker or an automatic machine or a machine operated by a robot.
- (vii) Work centre : A physical location where two or more identical workstations are located in order to provide the needed production capacity.
- (viii) Theoretical minimum number of workstations : The least number of work stations that can provide the required production calculated by :

$$N_t = \frac{\text{Sum of all task time } (\sum t)}{\text{Cycle time (CT)}}$$

$$\text{Cycle time} = \frac{\text{Available time}}{\text{Output required}}$$

- (ix) Actual number of workstations: The total number of workstations required on the entire production line, calculated as the next higher integer value of the number of workstations working.
- (x) Utilisation : The percentage of time that a production line is working. This is calculated as

$$\text{Utilisation or Balance efficiency} = \frac{\text{Minimum no. of workstations}}{\text{Actual no. of workstations}} \times 100 = \frac{\sum t}{CT \times N} \times 100$$

Line Balancing Procedure

Steps :

1. Calculate the cycle time and determine the theoretical minimum number of workstations

$$N_t = \frac{\sum t}{CT} = \frac{\text{Sum of all task time}}{\text{Cycle time}}$$

$$\text{Cycle time (CT)} = \frac{\text{Available time}}{\text{Output required}}$$



2. Compute the actual number of workstation (N) required by rounding up the theoretical number of workstations to the next higher integer value.
3. Assign the tasks to the workstations beginning with station 1. Tasks are assigned to work stations moving from left to right through the precedence diagram.
4. Before assigning each task to a workstation, use the following criteria to determine which tasks are eligible to be assigned to a workstation
 - (a) All preceding tasks in the sequence have been assigned already.
 - (b) The task time does not exceed the time remaining at the workstation.

If no tasks are eligible to be assigned to a particular workstation, move to the next workstation.
5. After each task assignment, determine the time remaining at the current work station by subtracting the sum of times for tasks already assigned to the work station from the cycle time.
6. When there is a tie between two tasks (parallel tasks) to be assigned, use one- of these rules :
 - (a) Assign the, task with the longest task time
 - (b) Assign the task with greatest number of followers.

If there is still a tie, choose one task arbitrarily,
7. Continue assignment of tasks until all tasks have been assigned to workstations.
8. Calculate the idle time (or balance delay), percent idle time and efficiency of balancing the line.

Illustration 20:

Table shows the time remaining (number of days until due date) and the work remaining (number of day's still required to finish the work) for 5 jobs which were assigned the letters A to E as they arrived to the shop. Sequence these jobs by priority rules viz., (a) FCFS, (b) EDD, (c) LS, (d) SPT and (e) LPT.

Job	Number days until due date	Number of day's of work remaining
A	8	7
B	3	4
C	7	5
D	9	2
E	6	6

Solution :

(a) FCFS (First come first served) : Since the jobs are assigned letters A to E as they arrived to the shop, the sequence according to FCFS priority rule is A B C D E

(b) EDD (Early due date job first) rule : Taking into account the number of days until due date, the sequence of jobs as per EDD rules is

Job	B	E	C	A	D
No. of days units/due date	3	6	7	8	9

Here the job having earliest due date is sequenced first and the others are sequenced in ascending order of due date.

(c) L.S. (Least slack) rule also called as Minimum slack rule.

**Calculation of slack :**

Slack = (Number of days until due date) - (Number of days of work remaining)

Job	No. of days until/due date	No. of days of work remaining	Slack (Days)
A	8	7	$8 - 7 = 1$
B	3	4	$3 - 4 = -1$
C	7	5	$7 - 5 = 2$
D	9	2	$9 - 2 = 7$
E	6	6	$6 - 6 = 0$

Sequence :

Job	B	E	A	C	D
Slack	-1	0	1	2	7

Here the jobs are sequenced in ascending order of magnitude of their respective slacks.

- (d) SPT (Shortest Processing Time job first) also referred as SOT (Shortest Operation time job First) rule or MINPRT (Minimum Processing time job first) rule. As per this rule, jobs are sequenced in ascending order of magnitude of their respective processing time.

Sequence :

Job	D	B	C	E	A
Processing Time (Days)	2	4	5	6	7

- (e) LPT (Longest Processing time job first) also referred to as LOT (Longest operation time job first) rule.

As per this rule jobs are sequenced in descending order of magnitude of their respective processing times.

Sequence :

Job	A	E	C	B	D
Processing Time (Days)	7	6	5	4	2

Illustration 21:

The following jobs have to be shipped a week from now (week has 5 working days)

Job	A	B	C	D	E	F
Number of days of work remaining	2	4	7	6	5	3

Sequence the jobs according to priority established by (a) least slack rule (b) critical ratio rule.



Solution :

(a) Calculation of slack :

Number of days until due date is 1 week i.e. 5 days for all jobs

Job (1)	No. of days until/due date (2)	No. of day of work remaining (3)	Slack (Days) (4) = (2) – (3)
A	5	2	3
B	5	4	1
C	5	7	-2
D	5	6	-1
E	5	5	0
F	5	3	2

Sequence :

Job	C	D	E	B	F	A
Slack (Days)	-2	-1	0	1	2	3

Jobs are sequenced in ascending order of magnitude of respective slack values.

(b) Calculation of Critical ratio :

$$\text{Critical ratio} = \frac{\text{Due Date-Date Now}}{\text{Lead Time Remaining}} = \frac{\text{DD-DN}}{\text{LTR}} = \frac{\text{Available time till due date}}{\text{Operation time still needed to complete the job}}$$

Critical ratio for job A = $5/2 = 2.5$

Critical ratio for job B = $5/4 = 1.25$

Critical ratio for Job C = $5/7 = 0.71$

Critical ratio for job D = $5/6 = 0.83$

Critical ratio for job E = $5/5 = 1.0$

Critical ratio for job F = $5/3 = 1.67$

Job having least critical ratio is given the first priority and so on.

Sequence :	C	D	E	B	F	A
Critical Ratio :	0.71	0.83	1.0	1.25	1.67	2.5

Illustration 22:

In a factory, there are six jobs to perform, each of which should go through two machines A and B, in the order AB. The processing timings (in hours) for the jobs are given here. You are required to determine the sequence for performing the jobs that would minimise the total elapsed time, T. What is the value of T?

Job	Machine A	Machine B
1	7	3
2	4	8
3	2	6
4	5	6
5	9	4
6	8	1



Solution:

- (a) The least of all the times given in the table is for job 6 on machine B. So, perform job 6 in the end. It is last in the sequence. Now delete this job from the given data.
- (b) Of all timings now, the minimum is for job 3 on machine A. So, do the job 3 first.
- (c) After deleting job 3 also, the smallest time of 3 hours is for job 1 on machine B. Thus, perform job 1 in the end (before job 6).
- (d) Having assigned job 1, we observe that the smallest value of 4 hours is shared by job 2 on machine A and job 5 on machine B. So, perform job 2 first and job 5 in the end.
- (e) Now, the only job remaining is job 4, it shall be assigned the only place left in the sequence. The resultant sequence of jobs is, therefore, as follows:

3		2		4		5		1		6
---	--	---	--	---	--	---	--	---	--	---

This sequence is the optimal one. The total elapsed time, T, is obtained in **Table 2.8.16** as equal to 36 hours

Table: Calculation of Total Elapsed Time (T)

<u>Job</u>	<u>Machine A</u>		<u>Machine B</u>	
	In	Out	In	Out
3	0	2	2	8
2	2	6	8	16
4	6	11	16	22
5	11	20	22	26
1	20	27	27	30
6	27	35	35	36

As shown in this table, the first job, job 3, starts at lime 0 on the machine A and is over by time 2, when it passes to machine B to be worked on till time 8. The job 2 starts on the machine A at time 2 as the machine is free at that lime. It is completed at time 6 and has to wait for 2 hours before it is processed on machine B, starting at time 8 when this machine is free, Similarly, the various jobs are assigned to the two machines and the in and out times are obtained.

4.8 LEAN OPERATIONS

Lean operation has its roots in the Toyota Automobile Co., of Japan, where waste was to be avoided at all costs:

- (i) the waste in time caused by having to repair faulty products
- (ii) the waste of investment in keeping high inventories and
- (iii) the waste of having idle workers.

The elements of lean production are:

- (i) To consider the organisation in terms of supply chain of value streams that extends from suppliers of raw materials, through transformation to the final customer.
- (ii) To organise workers in teams and to have every one in the organisation conscious of his or her work.
- (iii) To produce products of perfect quality and to have continuous quality improvement as a goal.
- (iv) To organise the operation by product or cellular manufacturing, rather than using a functional or process layout.
- (v) To operate the facility in a just-in-time mode.



4.9 JUST-IN-TIME (JIT)

Objectives of JIT manufacturing : The specific goal of JIT manufacturing is to provide the right quality level at the right place. Customer demand always determines *what is right*. JIT tries to build only what internal and external customers want and when they want it. The more focussed objectives of JIT are:

- (i) Produce only the products (goods or services) that customers want.
- (ii) Produce products only as quickly as customers want to use them.
- (iii) Produce products with perfect quality.
- (iv) Produce in the minimum possible lead times.
- (v) Produce products with features that customers want and no others.
- (vi) Produce with no waste of labour, materials or equipment, designate a purpose for every movement to leave zero idle inventory.
- (vii) Produce with methods that reinforce the occupational development of workers.

Overview of JIT manufacturing

JIT manufacturing includes many activities :

- (i) **Inventory reduction:** JIT is a system for reducing inventory levels at all stages of production viz. raw materials, work-in-progress and finished goods.
- (ii) **Quality improvement:** JIT provides a procedure for improving quality both within the firm and outside the firm.
- (iii) **Lead time reduction:** With JIT, lead time components such as set-up and move times are significantly reduced.
- (iv) **Vendor control/Performance improvement:** JIT gives the buying organisation greater power in buyer-supplier relationship. The firm moves from a situation where multiple suppliers are used to a situation where only one or two suppliers are used for supplying most of the parts. With fewer suppliers, the buying organisation has more power because it is making larger purchases from each vendor. Also, the buying organisation can now impose higher requirements on each supplier in terms of delivery and quality.
- (v) **Continuous Improvement:** In the JIT system, existing problems are corrected and new problems identified in a never-ending approach to operations management.
- (vi) **Total Preventive Maintenance:** JIT emphasises preventive maintenance to reduce the risk of equipment break-downs which may cause production hold ups and increase in manufacturing cycle time due to delays.
- (vii) **Strategic Gain:** JIT provides the firm's management with a means of developing, implementing and maintaining a sustainable competitive advantage in the market place.

4.10 TRANSPORTATION MODEL

Introduction

The basic transportation problem was originally developed by F.L. Hitchcock (1941) in his study entitled "the distribution of a product from several sources to numerous locations". In 1947, T.C. Koopmans independently published a study on "optimum utilization of the transportation system".

Transportation models deals with the transportation of a product manufactured at different plants or factories (supply origins) to a number of different warehouses (demand destinations). The objective is to satisfy the destination requirements within the plants capacity constraints at the minimum transportation cost. Transportation models thus typically arise in situations involving physical movement of goods from plants to warehouses, warehouses to wholesalers, wholesalers to retailers and retailers to customers. Solution of the transportation models requires the determination of how many units should be transported from each supply origin to each demands destination in order to satisfy all the destination demands while minimizing the total associated cost of transportation.

**Feasible Solution:**

A set of non-negative cell allocations of the given Cost Matrix whose elements are x_{ij} , $i=1, 2, \dots, m$; $j=1, 2, \dots, n$ that satisfies the total Demand and Supply requirement is called a feasible solution to the transportation problem.

Basic Feasible Solution:

An initial feasible solution with an allocation of $(m + n - 1)$ number of cells of the matrix whose elements are, x_{ij} , $i=1, 2, \dots, m$; $j=1, 2, \dots, n$ ($m = \text{No. of rows}$, $n = \text{No. of columns}$) is called a basic feasible solution.

Optimum Solution:

A feasible solution (not necessarily basic) is said to be optimum if it minimizes the total transportation cost.

Balanced or Unbalanced Transportation Problems:

A transportation problem can be balanced or unbalanced. It is said to be balanced if the total demand of all the warehouses equals the amount produced in all the factories. If in reality, capacity is greater than requirement, then a dummy warehouse may be used to create desired equality. If capacity is less than requirement, then a dummy factory may be introduced. The transportation cost in both the dummy cases is assumed to be zero.

Loops in Transportation Table:

In a transportation table, an ordered set of four or more cells is said to form a loop if any two adjacent cells in the ordered set lie either in the same row or in the same column. Moreover every loop has an even number of cells. It may be noted that a feasible solution to a T.P is basic if and only if the corresponding cells in the transportation table do not contain a loop.

Degeneracy of a Transportation Problem:

When the quantities are allocated to cost cells within the matrix and if such allocations are less than $m + n - 1$ allocations (where 'm' stands for no. of rows and 'n' stands for no. of columns), such a situation is said to be Degeneracy of a Transportation Problem.

METHOD OF SOLVING TRANSPORTATION PROBLEM:

Step - (A): Obtain a Basic Feasible Solution.

Step - (B): Test the solution obtained in Step (A) for optimality

Step - (C): If the operation of Step (B) suggests for a non optimal Solution then go to Step - (D)

Step - (D): Improve the basic feasible solution.

Step - (E): Repeat Steps (B), (C) & (D) until/optimal solution is obtained.

The following are the methods for obtaining Basic Feasible Solution of transportation problem:

1. The north-west corner rule
2. Lowest cost entry method
3. Vogel's approximation method

1. North West Corner Method (NWCM):

The simplest of the procedures used to generate an initial feasible solution is NWCM. It is so called because we begin with the north west or upper left corner cell of our transportation table. Various steps of this method can be summarized as under:

Step 1:

Select the north west (upper left-hand) corner cell of the transportation table and allocate as many units as possible equal to the minimum between available supply and demand requirement, i.e., $\min (s_1, d_1)$.

**Step 2:**

Adjust the supply and demand numbers in the respective rows and columns allocation.

Step 3:

- (a) If the supply for the first row is exhausted, then move down to the first cell in the second row and first column and go to step 2.
- (b) If the demand for the first column is satisfied, then move horizontally to the next cell in the second column and first row and go to step 2.

Step 4:

If for any cell, supply equals demand, then the next allocation can be made in cell either in the next row or column.

Step 5:

Continue the procedure until the total available quantity is fully allocated to the cells required.

2. Least Cost Method (LCM):

The allocation according to this method is very useful as it takes into consideration the lowest cost and therefore, reduces the computation as well as the amount of time necessary to arrive at the optimum solution. Various steps of this method can be summarized as under:

Step 1:

- (a) Select the cell with the lowest transportation cost among all the rows or columns of the transportation table.
- (b) If the minimum cost is not unique, then select arbitrarily any cell with this minimum cost.

Step 2:

Allocate as many units as possible to the cell determined in step 1 and eliminate that row (column) in which either supply is exhausted or demand is satisfied.

Step 3:

Repeat steps 1 and 2 for the reduced table until the entire supply at different factories is exhausted to satisfy the demand at different warehouses.

3. Vogel's Approximation Method (VAM):

This method is preferred over the other two methods because the initial basic feasible solution obtained is either optimum or very close to the optimum solution. Therefore, the amount of time required to arrive at the optimum solution is greatly reduced. Various steps of this method are summarized as under:

Step 1:

Compute a penalty for each row and column in the transportation table. The penalty for a given row and column is merely the difference between the smallest cost and the next smallest cost in that particular row or column.

Step 2:

Identify the row or column with the largest penalty. In this identified row or column, choose the cell which has the smallest cost and allocate the maximum possible quantity to the lowest cost cell in that row or column so as to exhaust either the supply at a particular source or satisfy demand at a warehouse.

If a tie occurs in the penalties, select that row/column which has minimum cost. If there is a tie in the minimum cost also, select that row/column which will have maximum possible assignments. It will considerably reduce computational work.



Step 3:

Reduce the row supply or the column demand by the amount assigned to the cell.

Step 4:

If the row supply is now zero, eliminate the row, if the column demand is now zero, eliminate the column, if both the row supply and the column demand are zero, eliminate both the row and column.

Step 5:

Recompute the row and column difference for the reduced transportation table, omitting rows or columns crossed out in the preceding step.

Step 6:

Repeat the above procedure until the entire supply at factories are exhausted to satisfy demand at different warehouses.

Illustration 23:

The cost conscious company requires for the next month 300, 260 and 180 tonnes of stone chips for its three constructions C1, C2 and C3 respectively. Stone chips are produced by the company at three mineral fields taken on short lease by the company. All the available boulders must be crushed into chips. Any excess chips over the demands at sites C1, C2 and C3 will be sold ex-fields.

The fields are M1, M2 and M3 which will yield 250, 320 and 280 tones of stone chips respectively.

Transportation costs from mineral fields to construction sites vary according to distances, which are given below in monetary unit (MU).

	To	C1	C2	C3
From	M1	8	7	6
	M2	5	4	9
	M3	7	5	5

- (i) Determine the optimal economic transportation plan for the company and the overall transportation cost in MU.
- (ii) What are the quantities to be sold from M1, M2 and M3 respectively?

Solution:

(i)

Table: 1 Cost Matrix

From \ To	C ₁	C ₂	C ₃	Supply
M ₁	8	7	6	250
M ₂	5	4	9	320
M ₃	7	5	5	280
Demand	300	260	180	850 750

From the given data we have Total Supply = 850 tonnes and total and total Demand = 740 tonnes i.e., Supply ≠ Demand.

So this is an unbalanced problem of transportation. To make it balanced we introduce a “Dummy” construction site of demand 850 – 740 = 110 tonnes and having zero cost elements for all the cells of the matrix corresponding to it.



Table: 2 Basic Feasible Solution by VAM (Optimal)

From \ To	C ₁	C ₂	C ₃	Dummy	Row Penalties				Row Nos. (u _i)			
					Supply	1st	2nd	3rd		4th		
M ₁	8	7	140	6	110	0	250 ¹⁴⁰	6*	2	1	1	u ₁ = 0
M ₂	300	5	20	4	9	0	320 ²⁰	4	1	5*	-	u ₂ = -2
M ₃	7	240	5	40	5	0	280 ⁴⁰	5	0	0	0	u ₃ = -1
Demand	300	240	40	180	110	0	850					
Column Penalties	1st	2	1	1	0							
	2nd	2*	1	1	-							
	3rd	-	1	1	-							
	4th	-	2*	1	-							
Column Nos. (v _j)	v ₁ = 7	v ₂ = 6	v ₃ = 6	v ₄ = 0								

Row Penalty = 2nd lowest cost figure of a row – Lowest cost figure of that row.

For the **1st Set of Row Penalties** –

(a) For 1st row, 2nd lowest cost = 6 and lowest cost = 0

∴ Penalty = 6 – 0 = 6

(b) For 2nd Row, 2nd lowest cost = 4 and Lowest cost = 0

∴ Penalty = 4 – 0 = 4

(c) For 3rd Row, 2nd lowest cost = 5 and Lowest cost = 0,

∴ Penalty = 5 – 0 = 5

Similarly, **Column Penalty** = 2nd lowest cost figure of a column – Lowest cost figure of that column

For the **1st Set of Column Penalties** –

(a) For 1st column, 2nd lowest cost = 7 and Lowest cost = 5, ∴ Penalty = 7 – 5 = 2

(b) For 2nd column, 2nd lowest cost = 5 and Lowest cost = 4, ∴ Penalty = 5 – 4 = 1

(c) For 3rd column, 2nd lowest cost = 6 and Lowest cost = 5, ∴ Penalty = 6 – 5 = 1

Of all these Row and Column penalties of 1st set, 6 is highest and it corresponds to 1st Row.

Hence allocation should be done at that cell of 1st Row where cost is least. This corresponds to the cell (M₁ – Dummy). So maximum possible unit of 110 is allocated in this cell by maintaining parity of supply and demand. With this allocation the total demand of 'Dummy' site is exhausted. But the supply of the corresponding Mineral Field (M₁) is not fully exhausted. Remaining supply capacity of M₁, i.e. 250 – 110 = 140 tonnes is shown as balance in the supply cell of M₁. As the demand of 'Dummy' is fulfilled, the entire column for this has been shaded indicating the same. Figures of this column will no longer participate in any of the subsequent calculations of Penalty (for Rows as well as columns)

The same procedure of calculating penalty for Rows and Columns and subsequently allocating maximum possible quantity in the least cost cell corresponding to highest penalty is repeated until all the allocations are made maintaining parity of Supply and Demand.



The solution thus obtained is the **Basic Feasible Solution**. It is given as follows.

Table: Showing Optimum Allocation

Cell	Allocation	Cost of Transportation (₹)
$M_1 - C_3$	140 tonnes	$140 \times 6 = 840$
$M_1 - \text{Dummy}$	110 tonnes	$110 \times 0 = 0$
$M_2 - C_1$	300 tonnes	$300 \times 5 = 1500$
$M_2 - C_2$	20 tonnes	$20 \times 4 = 80$
$M_3 - C_2$	240 tonnes	$240 \times 5 = 1200$
$M_3 - C_3$	40 tonnes	$40 \times 5 = 200$
Total	850 tonnes	₹ 3820

Here, m = No. of rows of the matrix = 3

n = No. of columns of the matrix = 4

$$\therefore m + n - 1 = 3 + 4 - 1 = 6$$

Also, no. of allocated cells = 6

As, no. of allocated cells = 6 = $m + n - 1$, the solution is a **non degenerate** one.

Now the solution is tested for **OPTIMALITY**.

For this, Row Nos. (u_i) and column nos. (v_j) are calculated by using the equation $C_{ij} = u_i + v_j$ for all the **allocated cells**, where C_{ij} = Cost figure of the cell i - j .

Allocated Cell	C_{ij}	$C_{ij} = u_i + v_j$			
$M_1 - C_3$	$C_{13} = 6$	$C_{13} = u_1 + v_3$	or, $6 = u_1 + v_3$	or, $6 = 0 + v_3$ (Assume $u_1 = 0$) or, $v_3 = 6$	(1)
$M_1 - \text{Dummy}$	$C_{14} = 0$	$C_{14} = u_1 + v_4$	or, $0 = u_1 + v_4$	or, $0 = 0 + v_4$ or, $v_4 = 0$	(2)
$M_2 - C_1$	$C_{21} = 5$	$C_{21} = u_2 + v_1$	or, $5 = u_2 + v_1$	or, $5 = -2 + v_1$ or, $v_1 = 7$	(6)
$M_2 - C_2$	$C_{22} = 4$	$C_{22} = u_2 + v_2$	or, $4 = u_2 + v_2$	or, $4 = u_2 + 6$ or, $u_2 = -2$	(5)
$M_3 - C_2$	$C_{32} = 5$	$C_{32} = u_3 + v_2$	or, $5 = u_3 + v_2$	or, $5 = -1 + v_2$ or, $v_2 = 6$	(4)
$M_3 - C_3$	$C_{33} = 5$	$C_{33} = u_3 + v_3$	or, $5 = u_3 + v_3$	or, $5 = u_3 + 6$ or, $u_3 = -1$	(3)

Hence no. of equations = 6 and no. of unknowns = 7. So to start with a solution, it is assumed $u_1 = 0$. thereafter all the other row nos. and column nos. are calculated. The sequence of usage of the above equations is indicated as (1), (2), (3), (6).

Next opportunity cost (Δ_{ij}) for all the **unallocated cells** are calculated using $\Delta_{ij} = C_{ij} - (u_i + v_j)$

Unallocated Cell	C_{ij}	Opportunity Cost [$\Delta_{ij} = C_{ij} - (u_i + v_j)$]
$M_1 - C_1$	$C_{11} = 8$	$\Delta_{11} = C_{11} - (u_1 + v_1) = 8 - (0 + 7) = 1$
$M_1 - C_2$	$C_{12} = 7$	$\Delta_{12} = C_{12} - (u_1 + v_2) = 7 - (0 + 6) = 1$
$M_2 - C_3$	$C_{23} = 9$	$\Delta_{23} = C_{23} - (u_2 + v_3) = 9 - (-2 + 6) = 5$
$M_2 - \text{Dummy}$	$C_{24} = 0$	$\Delta_{24} = C_{24} - (u_2 + v_4) = 0 - (-2 + 0) = 2$
$M_3 - C_1$	$C_{31} = 7$	$\Delta_{31} = C_{31} - (u_3 + v_1) = 7 - (-1 + 7) = 1$
$M_3 - \text{Dummy}$	$C_{34} = 0$	$\Delta_{34} = C_{34} - (u_3 + v_4) = 0 - (-1 + 0) = 1$

As all the opportunity cost values are nonnegative, the solution is optimal.



- (i) So the optimal transportation plan is as shown in Table-3 and minimum cost of transportation is ₹ 3820/-
- (ii) Quantities to be produced by M_1 , M_2 and M_3 are respectively 250,320 and 280 tonne of which 110 tonnes worth of stone chips produced by M_1 will remain unused by the construction sites. So this quantity can be sold ex-field.

Illustration 24:

Ladies fashion shop wishes to purchase the following quantity of summer dresses:

Dress size	I	II	III	IV
Quantity	100	200	450	150

Three manufacturers are willing to supply dresses.

The quantities given below are the maximum that they are able to supply of any given combination of orders for dresses:

Manufacturers	A	B	C
Total quantity	150	450	250

The shop expects the profit per dress to vary with the manufacturer as given below:

Size

	I	II	III	IV
A	₹2.5	₹4.0	₹5.0	₹2.0
B	₹3.0	₹3.5	₹5.5	₹1.5
C	₹2.0	₹4.5	₹4.5	₹2.5

Required:

- (a) Use the transportation technique to solve the problem of how the orders should be placed with the manufacturers by the fashion shop is order to maximise profit.
- (b) Explain how you know there is no further improvement possible.

Solution:

Table: 1 Profit Matrix

Dress Size Manufacturer	I	II	III	IV	Supply
	2.5	4	5	2	150
B	3	3.5	5.5	1.5	450
C	2	4.5	4.5	2.5	250
Demand	100	200	450	150	850 900

Maximum possible supply capability of manufacturer = 850 units

Total Demand = 900 units



As Supply \neq demand, the problem is an unbalanced one. To make it balanced, a 'Dummy' manufacturer of supply capacity = $900 - 850 = 50$ units. is introduced. The profit figures for it are all zeros.

Also it is a problem of maximisation, to convert it to a problem of minimisation, a Relative Loss matrix is formed by subtracting all the profit figures given in the above matrix as well as those of Dummy from the highest profit (5.5) figure of the given matrix.

Table : 2 Relative Loss Matrix with Basic Feasible Solution

Dress Size Manu- facturer	I	II	III	IV	Supply	Row Penalties		
						1st	2nd	3rd
A	100 3	1.5	0.5	50 3.5	150 ⁵⁰	1	1.5	0.5*
B	2.5	2	450 0	4	450	2*	-	-
C	3.5	200 1	1	50 3	250 ⁵⁰	0	2*	0.5
Dummy	5.5	5.5	5.5	50 5.5	50	0	0	0
Demand	100	200	450	150	900			
Column Penalties	1st	0.5	0.5	0.5				
	2nd	0.5	0.5	-	0.5			
	3rd	0.5	-	-	0.5			

Here, m = No. of rows of the matrix = 4 and n = No. of columns of the matrix = 4

$$\therefore m + n - 1 = 4 + 4 - 1 = 7$$

Also no. of allocated cells = 6 \neq (m+ n - 1)

So the solution is a **degenerate** one. To resolve this, we make use of an artificial quantity ' ϵ ' and allocate this quantity at the unallocated cell which is having least cost among all the unallocated cells. It can be mentioned that the quantity ' ϵ ' is very small and for all practical purposes its value can be taken as zero.

Least cost unallocated cell is (A-III) where allocation of ' ϵ ' has to be made.

Table : 3 Showing Basic Feasible Solution (Optimal)

Dress Size Manufacturer	I	II	III	IV	Supply	Row Nos. (u_i)
A	100 3	1.5	ϵ 0.5	50 3.5	150	$u_1 = 0$
B	2.5	2	450 0	4	450	$u_2 = -0.5$
C	3.5	200 1	1	50 3	250	$u_3 = -0.5$
Dummy	5.5	5.5	5.5	50 5.5	50	$u_4 = 2$
Demand	100	200	450	150	900	
Column Nos. (v_j)	$v_1 = 3$	$v_2 = 1.5$	$v_3 = 0.5$	$v_4 = 3.5$		

To test optimality of the Basic Feasible Solution, Row Nos. (u_i) and Column Nos. (v_j) are calculated using the equation $C_{ij} = u_i + v_j$ for the allocated cells, where C_{ij} = Relative Loss figure of the cell i - j.



Allocated cell	A-I	A-III	A-IV	B-III	C-II	C-IV	Dummy-IV
C_{ij}	$C_{11} = 3$	$C_{13} = 0.5$	$C_{14} = 3.5$	$C_{23} = 0$	$C_{32} = 1$	$C_{34} = 3$	$C_{44} = 5.5$

$C_{11} = u_1 + v_1$ or, $3 = 0 + v_1$ [$u_1 = 0$, Assumed] or, $v_1 = 3$

$C_{13} = u_1 + v_3$ or, $0.5 = 0 + v_3$ or, $v_3 = 0.5$; $C_{14} = u_1 + v_4$ or, $3.5 = 0 + v_4$ or, $v_4 = 3.5$

$C_{23} = u_2 + v_3$ or, $0 = u_2 + 0.5$ or, $u_2 = -0.5$; $C_{34} = u_3 + v_4$ or, $3 = u_3 + 3.5$ or, $u_3 = -0.5$

$C_{32} = u_3 + v_2$ or, $1 = -0.5 + v_2$ or, $v_2 = 1.5$; $C_{44} = u_4 + v_4$ or, $5.5 = u_4 + 3.5$ or, $u_4 = 2$

Opportunity Loss figures (Δ_{ij}) for all the unallocated cells are calculated using the equation $\Delta_{ij} = C_{ij} - (u_i + v_j)$

Unallocated Cell

Opportunity Loss (Δ_{ij})

A - II $\Delta_{12} = C_{12} - (u_1 + v_2) = 1.5 - (0 + 1.5) = 0$

B - I $\Delta_{21} = C_{21} - (u_2 + v_1) = 2.5 - (-0.5 + 3) = 0$

B - II $\Delta_{22} = C_{22} - (u_2 + v_2) = 2 - (-0.5 + 1.5) = 1$

B - IV $\Delta_{24} = C_{24} - (u_2 + v_4) = 4 - (-0.5 + 3.5) = 1$

C - I $\Delta_{31} = C_{31} - (u_3 + v_1) = 3.5 - (-0.5 + 3) = 1$

C - III $\Delta_{33} = C_{33} - (u_3 + v_3) = 1 - (-0.5 + 0.5) = 1$

Dummy - I $\Delta_{41} = C_{41} - (u_4 + v_1) = 5.5 - (2 + 3) = 0.5$

Dummy - II $\Delta_{42} = C_{42} - (u_4 + v_2) = 5.5 - (2 + 1.5) = 2$

Dummy - III $\Delta_{43} = C_{43} - (u_4 + v_3) = 5.5 - (2 + 1.5) = 3$

As all the opportunity loss values are non negative, the solution is optimal.

Table Showing Optimum allocation of orders quantities

From Manufacturer	Dress Size	Allocated Quantity	Profit/unit (₹)	Total (₹)
(i)	(ii)	(iii)	(iv)	(v) = (iii) × (iv)
A	I	100 units	2.5	250
	IV	50 units	2	100
B	III	450 units	5.5	2475
C	II	200 units	4.5	900
	IV	50 units	2.5	125
Dummy	IV	50 units	0	0
Total	-	900 units	-	₹ 3850

Maximum Profit = ₹ 3850/-



Illustration 25:

The products of three plants F1, F2 and F3 are to be transported to 5 warehouses W1, W2, W3, W4 and W5. The capacities of plants, demand of warehouses and the cost of transportation from one plant to various warehouses are indicated in the following table:

	W1	W2	W3	W4	W5	Plant Capacity
F1	74	56	54	62	68	400
F2	58	64	62	58	54	500
F3	66	70	52	60	60	600
Warehouse Demand	200	280	240	360	320	1500/1400

- Find out a distribution plan of products from plants to the warehouses at a minimum cost. What is the minimum cost?
- Is there any surplus capacity of the plants? If so, in which plant should we associate that surplus capacity?
- Is there any alternate solution for the optimum solution achieved in

Solution:

- From the given data total plant capacity (1500 units) is more than the total demand of warehouses (1400 units). So the problem is unbalanced. To make it balanced, a 'Dummy' warehouse of demand 1500 – 1400 = 100 units is introduced. Cost figures corresponding to various cells of this 'Dummy' are zeros.

Table : 1 Basic Feasible Solution

Warehouse Plant	W1	W2	W3	W4	W5	Dummy	Plant Capacity	Row Penalties					
	1	2	3	4	5	6		1	2	3	4	5	6
F1	74	56	54	62	68	0	400	54	2	6	6	6	6
F2	58	64	62	58	54	0	500	*	4	4	4	4	---
F3	66	70	52	60	60	0	600	52	*	0	0	0	0
Warehouse Demand	200	280	240	360	320	100	1500						
Column Penalties	1	8	8	2	2	6	0						
	2	8	8	2	2	6	---						
	3	8	8*	---	2	6	---						
	4	8*	---	---	2	6	---						
	5	---	---	---	2	6*	---						
	6	---	---	---	2	8*	---						

Here, m = No. of rows = 3

n = No. of columns = 6

$$m+n - 1 = 3 + 6 - 1 = 8$$

Also no. of allocated cells = 8 = m+n - 1.

So the solution is **nondegenerate**.



Table : 2 Showing Basic Feasible Solution (Non Optimal)

Warehouse \ Plant	W ₁	W ₂	W ₃	W ₄	W ₅	Dummy	Plant Capacity	Row Nos. (U _j)	
F ₁	74	280	56	54	120	62	68	0	U ₁ = 8
F ₂	200	58	64	62	58	200	54	100	U ₂ = 0 (Let)
F ₃	66	70	240	52	240	60	60	0	U ₃ = 6
Warehouse Demand	200	280	240	360	320	100	1500		
Column Nos. (V _j)	V ₁ = 58	V ₂ = 48	V ₃ = 46	V ₄ = 54	V ₅ = 54	V ₆ = 0			

Calculation of Opportunity Costs for Basic Feasible Solution

Unallocated Cell	Opportunity Cost [$\Delta_{ij} = C_{ij} - (u_i + v_j)$]
F ₁ - W ₁	$\Delta_{11} = C_{11} - (u_1 + v_1) = 74 - (8 + 58) = 8$
F ₁ - W ₃	$\Delta_{13} = C_{13} - (u_1 + v_3) = 54 - (8 + 46) = 0$
F ₁ - W ₅	$\Delta_{15} = C_{15} - (u_1 + v_5) = 68 - (8 + 54) = 6$
F ₁ - Dummy	$\Delta_{16} = C_{16} - (u_1 + v_6) = 0 - (8 + 0) = - 8$
F ₂ - W ₂	$\Delta_{22} = C_{22} - (u_2 + v_2) = 64 - (0 + 48) = 16$
F ₂ - W ₃	$\Delta_{23} = C_{23} - (u_2 + v_3) = 62 - (0 + 46) = 16$
F ₂ - W ₄	$\Delta_{24} = C_{24} - (u_2 + v_4) = 58 - (0 + 54) = 4$
F ₃ - W ₁	$\Delta_{31} = C_{31} - (u_3 + v_1) = 66 - (6 + 58) = 2$
F ₃ - W ₂	$\Delta_{32} = C_{32} - (u_3 + v_2) = 70 - (6 + 48) = 16$
F ₃ - Dummy	$\Delta_{36} = C_{36} - (u_3 + v_6) = 0 - (6 + 0) = - 6$

As all the Opportunity Costs are not nonnegative, the solution is non optimal i.e. further improvement is possible. For this a loop is formed starting from the cell having highest negative value which is cell (F₁ - Dummy) having a highest negative opportunity cost value of -8. The starting cell of the loop is marked with a (+) and thereafter alternately the corner cells of the loop are marked (-) and (+). Next the minimum of the allocated quantities of the cells marked (-) is subtracted from the allocated quantities of all the cells marked (-) and added to all the cells marked (+). This leads to an improved solution as shown below.

Table : 3 Showing Improved Solution (Optimal)

Warehouse Plant	W ₁	W ₂	W ₃	W ₄	W ₅	Dummy	Plant Capacity	Row Nos. (U _j)
F ₁	74 8	280 56	0 54	20 62	68	100	400	U ₁ = 0 (Let)
F ₂	200 58	16 64	16 62	4 58	300 54	8	500	U ₂ = -8
F ₃	2 66	16 70	240 52	340 60	20 60	2	600	U ₃ = -2
Warehouse Demand	200	280	240	360	320	100	1500	
Column Nos. (V _j)	V ₁ = 66	V ₂ = 56	V ₃ = 54	V ₄ = 62	V ₅ = 62	V ₆ = 0		

Opportunity Costs (Δ_{ij}) for the unallocated cells are calculated same as before and shown in left bottom corner of the cells.

As $\Delta_{ij} \geq 0$, the solution is optimal.

Table -4: Showing Optimal Distribution Plan

From Plant	To Warehouse	Quantity (Units)	Cost/Unit (₹)	Total (₹)
(1)	(2)	(3)	(4)	(5) = (3) × (4)
F ₁	W ₂	280	56	15680
	W ₄	20	62	1240
	Dummy	100	0	0
F ₂	W ₁	200	58	11600
	W ₅	300	54	16200
F ₃	W ₃	240	52	12480
	W ₄	340	60	20400
	W ₅	20	60	1200
Total		1500	-	₹ 78800

Minimum Cost of Transportation is ₹ 78800



(b) Plant F_1 is having a surplus quantity of 100 units.

(c) Presence of zero opportunity cost (in the cell $F_1 - W_3$) indicates that alternative optimum solution is possible for the problem. To get the solution, we form a loop starting from the cell $F_1 - W_3$. The new solution is shown below–

Table-5: Showing Alternative Optimum Solution

Warehouse	W_1	W_2	W_3	W_4	W_5	Dummy	Plant Capacity
F_1	74	56	54	62	68	0	400
		(280)	(20)			(100)	
F_2	58	64	62	58	54	0	500
	(200)				(300)		
F_3	66	70	52	60	60	0	600
			(220)	(360)	(20)		
Warehouse Demand	200	280	240	360	320	100	1500

Table-6: Showing Alternative Optimum Distribution Plan

From Plant	To Warehouse	Quantity (Units)	Cost/Unit (₹)	Total (₹)
(1)	(2)	(3)	(4)	(5) = (3) × (4)
F_1	W_2	280	56	15680
	W_3	20	54	1080
	Dummy	100	0	0
F_2	W_1	200	58	11600
	W_5	300	54	16200
F_3	W_3	220	52	11440
	W_4	360	60	21600
	W_5	20	60	1200
Total		1500	–	₹ 78800

So the alternative solution is given above.



Illustration 26:

A manufacturer has distribution centres X, Y, and Z. These centres have 40,20 and 40 units of his product. His retail outlets at A, B, C, D and E require 25,10,20,30 and 15 units respectively. The transport cost in (Rupees/Unit) between each centre and each outlet is given in the following table:

Distribution Centre	Retail outlets				
	A	B	C	D	E
X	55	30	40	50	40
Y	35	30	100	45	60
Z	40	60	95	35	30

We have to find out the optimum distribution cost.

Solution:

Initial Basic Feasible Solution

		Retail Outlets					Capacity of the centres	Row Penalties					Column Nos. (u_i)
		A	B	C	D	E		1	2	3	4	5	
		Distribution Centres	X	55	30	40		50	40	40/20/10/5/0	10	10*	
Y	35		30	100	45	60	20/0	5	5	10	10	10	(u_2)=20
Z	40		60	95	35	30	40/25/0	5	5	5	5	-	(u_3)=15
Requirements of the outlets		25	10	20	30	15							
Column Penalties	1	5	0	55*	10	10							
	2	5	0	-	10	10							
	3	5	-	-	10	10*							
	4	5	-	-	10*	-							
	5	* 20	-	-	5	-							
Column Nos. (v_j)		$v_1 = 55$	$v_2 = 30$	$v_3 = 40$	$v_4 = 50$	$v_5 = 45$							

Here m = No. of rows = 3, n = No. of columns = 5

$$m+n-1 = 3+5-1 = 7$$

Also no. of allocated cells = 7

So the solution is **nondegenerate**



Table - 1 Showing Initial Basic Feasible Solution (Non Optional)

Retail Outlets Distribution Centres	A	B	C	D	E	Capacity of the centres	Row Nos. (u_j)
X	55 (5)	30 (10)	40 (20)	50 (5)	40 (+)	40	$u_1 = 0$
Y	35 (20)	30 (20)	100 (80)	45 (15)	60 (35)	20	$u_2 = -20$
Z	40 (0)	60 (45)	95 (70)	35 (25)	30 (-)	40	$u_3 = -15$
Requirement of the Outlets	25	10	20	30	15		
Column Nos. (v_j)	$v_1 = 55$	$v_2 = 30$	$v_3 = 40$	$v_4 = 50$	$v_5 = 45$		

Opportunity Costs (Δ_{ij}) for the Unallocated Cells are calculated using the formula $[\Delta_{ij} = C_{ij} - (u_i + v_j)]$ and shown in the left bottom corner of the cells. As all the Opportunity Costs are not non-negative, the solution is nonoptimal i.e. further improvement is possible. For this, a loop is formed starting from the cell having highest negative opportunity cost which is cell (X-E) having highest negative opportunity cost of -5. The starting cell of the loop is marked (+) and thereafter alternately the cells at the corner of the loop are marked with (-) & (+). Next the minimum of the allocated quantities of the cells marked (-) is subtracted from the allocations of the cells marked (-) and added to the allocations of the cells marked (+). Improved solution obtained thus is shown below:

Table - 2 Showing Improved Solution (Nonoptimal)

Retail Outlets Distribution Centres	A	B	C	D	E	Capacity of the centres	Row Nos. (u_j)
X	55 (5)	30 (10)	40 (20)	50 (5)	40 (+)	40	$u_1 = 0$ (let)
Y	35 (20)	30 (20)	100 (80)	45 (20)	60 (40)	20	$u_2 = -20$
Z	40 (-5)	60 (40)	95 (65)	35 (30)	30 (-)	40	$u_3 = -10$
Requirement of the Outlets	25	10	20	30	15		
Column Nos. (v_j)	$v_1 = 55$	$v_2 = 30$	$v_3 = 40$	$v_4 = 45$	$v_5 = 40$		

Opportunity costs for the unallocated cells are calculated some as before & shown in the left bottom corner of the unallocated cells.

Table - 3 Sharing Improved Solution (Optimal)

Distribution Centres \ Retail Outlets	A	B	C	D	E	Capacity of the centres	Row Nos. (u_j)
	X	55 5	30 ⑩	40 ②①	50 5		
Y	35 ②①	30 15	100 75	45 15	60 35	20	$u_2 = -15$
Z	⑤ 40	60 40	95 65	35 ③①	30 ⑤	40	$u_3 = -10$
Requirement of the Outlets	25	10	20	30	15		
Column Nos. (v_j)	$v_1 = 50$	$v_2 = 30$	$v_3 = 40$	$v_4 = 45$	$v_5 = 40$		

Opportunity Costs (Δ_{ij}) are calculated same as before for the Unallocated cells. As all the Opportunity Costs (Δ_{ij}) are nonnegative, the solution is optimal.

Table - 4 Showing Optimum Distribution Plan

From Distribution Centre	To Retail Outlets	Quantity (Units)	Cost/Unit (₹)	Total (₹)
(1)	(2)	(3)	(4)	(5) = (3) × (4)
X	B	10	30	300
	C	20	40	800
	E	10	40	400
Y	A	20	35	700
Z	A	5	40	200
	D	30	35	1,050
	E	5	30	150
Total Distribution Cost				3,600

Illustration 27:

Priyanshu enterprise has three factories at locations A, B and C which supply three warehouses located at D, E and F. Monthly factory capacities are 10, 80 and 15 units respectively. Monthly warehouse requirements are 75, 20 and 50 units respectively. Unit shipping costs (in ₹) are given in the following table:

	To	D	E	F
	A	5	1	7
From	B	6	4	6
	C	3	2	5

The penalty costs for not satisfying demand at the warehouses D, E and F are ₹ 5, ₹ 3 and ₹ 2 per unit respectively. Determine the optimum distribution for Priyanshu, using any of the known algorithms.



Solution:

Here total monthly capacity of Factories A, B & C = 10 + 80 + 15 = 105 units

Also total monthly requirement of Warehouses D, E & F = 75 + 20 + 50 = 145 units

So supply \neq Demand i.e. the problem is unbalanced. To make it balanced, we introduce a Dummy Factory having monthly capacity = 145 – 105 = 40 units and unit cost of transportation to any warehouse from this Dummy is taken to be zero.

Table - 1 Sharing Initial Basic Feasible Solution (Optimal)

Warehouse Factory	D	E	F	Capacity	Row Penalties			Row Nos. (u_i)
					1	2	3	
A	2	5 10	1 4	7 10	4	4*	-	$u_1 = -3$
B	60	6 10	4 10	6 10	2	2	2	$u_2 = 0$ (let)
C	15	3 1	2 2	5 15	1	1	1	$u_3 = -3$
Dummy	0	0 2	0 40	0 40	0	-	-	$u_4 = -6$
Requirement	75 60	20 10	50 10					
Column Penalties	1	3	1	5*				
	2	2	1	1				
	3	3*	2	1				
Column Nos. (v_j)	$v_1 = 6$	$v_2 = 4$	$v_3 = 6$					

Here, m = No. of rows = 4 and n = No. of columns = 3

$m + n - 1 = 4 + 3 - 1 = 6$ = No. of cell allocations

So the solution is **nondegenerate**

Now Row Nos. (u_i) and Column Nos. (v_j) are calculated using the formula $C_{ij} = u_i + v_j$ for all the Allocated Cells. Also to start with, it is assumed that $u_2 = 0$

Next, Opportunity Costs (Δ_{ij}) are calculated for all the Unallocated Cells using the formula $\Delta_{ij} = C_{ij} - (u_i + v_j)$ and written at the left bottom corner of the Unallocated Cells.

As $\Delta_{ij} \geq 0$, the solution is optimal.

Optimum Distribution Plan

From Factory	To Warehouse	Quantity (Units)	Cost/Unit (₹)	Total (₹)
(1)	(2)	(3)	(4)	(5) = (3) × (4)
A	E	10	1	10
B	D	60	6	360
	E	10	4	40
	F	10	6	60
C	D	15	3	45
Dummy	F	40	2*	80

Minimum total cost = 10 + 360 + 40 + 60 + 45 + 80
= ₹ 595

This cost is the penalty for not meeting the demand of F.



Illustration 28:

The products of two plants A and B are to be transported to 3 warehouses W1, W2 and W3. The cost of transportation of each unit from plants to the warehouses are indicated below:

Warehouses				
Plants	(W1)	(W2)	(W3)	Capacities
A	25	17	25	300
B	15	10	18	500
Demand	300	300	500	800/1100

Find the optimum distribution and the optimum cost.

Solution:

This is an unbalanced problem with Supply Capacity = 800 Units and Demand = 1100 units. So a dummy plant C of capacity 1100 - 800 = 300 units is introduced. Unit Cost of transportation from this plant to each of the warehouse is taken to be zero.

		Warehouse			Capacities	Row Penalties		
		W1	W2	W3		1	2	3
Plants	A	25	17	25	300 /0	8	8	8
	B	15	10	18	500 / 200 /0	5	5	8
	C	0	0	0	300 /0	0	-	-
Demand		300 0	300 100 0	500 200 0	Here m = No. of rows = 3 n = No. of columns = 3 m + n - 1 = 3 + 3 - 1 = 5			
Column Penalties	1	15	10	18*	Also no. of cell allocation = 5 So the solution is nondegenerate.			
	2	10*	7	7				
	3	-	7	7				

Plants \ Warehouses	W ₁	W ₂	W ₃	Row Nos. (u _i)
	A	25	17	25
B	15	10	18	u ₂ = -7
C	0	0	0	u ₃ = -25
Column Nos.	v ₁ = 22	v ₂ = 17	v ₃ = 25	

Row Nos. (u_i) and Column Nos. (v_j) are calculated using the formula $C_{ij} = u_i + v_j$ for all the Allocated Cells.

Also it is assumed, $u_1 = 0$ to start with.

Opportunity Costs (Δ_{ij}) are calculated using the formula

$\Delta_{ij} = C_{ij} - (u_i + v_j)$ for all the Unallocated Cells and written at the right bottom corner of the cells.

As $\Delta_j \geq 0$, the solution is optimum. Therefore the Distribution Plan having minimum cost is as follows:

From Plant	To Warehouse	Quantity (Units)	Minimum Cost
A	W2	100	$100 \times 17 = 1700$
	W3	200	$200 \times 25 = 5000$
B	W1	300	$300 \times 15 = 4500$
	W2	200	$200 \times 10 = 2000$
Dummy	W3	300	$300 \times 0 = 0$
		1100 Units	Min. Total Cost = ₹ 13200

Optimum cost: ₹ 13,200

4.11 LINEAR PROGRAMMING TECHNIQUE

Introduction

Linear Programming is an optimization technique. It is **“a technique for specifying how to use limited resources or capacities of a business to obtain a particular objective, such as least cost, highest margin or least time, when those resources have alternate uses”**.

The situation which require a search for **“best”** values of the variables, **subject to** certain constraints, are amenable to programming analysis. These situations cannot be handled by the usual tools of calculus or marginal analysis. The calculus technique can only handle **exactly equal** constraints, while this limitation does not exist in case of linear programming problem.

A linear programming problem has two basic parts.

- The first part is the objective function, which describes the primary purpose of the formulation – to maximize some return (for example, profit) or to minimize some cost (for example, production cost or investment cost).
- The second part is the constraint set. It is the system of equalities and/or inequalities, which describes the restrictions (conditions or constraints) under which optimization is to be accomplished.

Definition of Linear Programming

According to Kohlar **“A method of planning and operation involved in the construction of a model of a real situation containing the following elements: (a) variables representing the available choices, and (b) mathematical expressions (i) relating the variables to the controlling conditions, and (ii) reflecting the criteria to be used in measuring the benefits derivable from each of the several possible plans, and (iii) establishing the objective. The method may be so devised as to ensure the selection of the best of a large number of alternatives”**.

Samuelson, Dorfman and Solow defines LP as **“The analysis of problems in which a linear function of a number of variables is to be maximized (or minimized) when those variables are subject to a number of restraints in the form of linear inequalities”**.

In the words of Loomba, **“LP is only one aspect of what has been called a system approach to management wherein all programmes are designed and evaluated in terms of their ultimate affects in the realization of business objectives”**.



Application Areas of Linear Programme

In practice linear programming has proved to be one of the most widely used technique of managerial decision making in business, industry and numerous other fields.

1. Industrial Applications

Linear programming is extensively used to solve a variety of industrial problems. In each of these applications, the general objective is to determine a plan for production and procurement in the time period under consideration. It is necessary to satisfy all demand requirements without violating any of the constraints. Few examples of industrial applications are as follows:

- (a) Product Mix-Problem.
- (b) Production Scheduling.
- (c) Production Smoothing Problem.
- (d) Blending Problems.
- (e) Transportation Problems.
- (f) Production distribution problems.
- (g) Trim Loss.
- (h) Linear programming is also used by oil refineries to determine the optimal mix of products to be produced by the refinery during a given period.
- (i) Communication Industry. LP methods are used in solving problems involving facilities for transmission, switching, relaying etc.
- (j) Rail Road Industry: An LP model for optimal programming of railway freight, and train movements has been formulated to handle scheduling problems as found at large terminal switching rail points.

2. Management Applications:

- (a) Portfolio Selection.
- (b) Financial Mix Strategy.
- (c) Profit Planning.
- (d) Media Selection.
- (e) Travelling Salesmen Problem.
- (f) Determination of equitable salaries.
- (g) Staffing problem.

3. Miscellaneous Applications:

The additional application of Linear Programming are as follows:

- (a) Form planning.
 - The particular crops to be grown or cattle to keep during a period
 - The acreage to be devoted to each, and
 - The particular production methods to be used.
- (b) Airline routine.
- (c) Administration, Education and Politics have also employed linear programming to solve their problems.
- (d) Diet Problems. The diet problem, one of the earliest applications of linear programming was originally used by hospitals to determine the most economical diet for patients.



4. Administrative applications of Linear Programming:

Linear programming can be used for administrative applications. Administrative applications of Linear Programming are concerned with optimal usage of resources like men, machine and material.

5. Non-Industrial applications of linear programming:

Linear programming techniques/tools can be applied in the case of non-industrial applications as well. Examples of the use of L.P techniques for non-industrial applications are given below:

- Agriculture.
- Environmental Protection.
- Urban Department.
- Facilities Location.

6. Further applications of Linear Programming are:

- In structural design for maximum product.
- In balancing assembly lines.
- In scheduling of a military tanker fleet.
- In determining which parts to make and which to buy to obtain maximum profit margin.
- In selecting equipment and evaluating methods improvements that maximize profit margin.
- In planning most profitable match of sales requirements to plant capacity that obtains a fair share of the market.
- In design of optimal purchasing policies.

FORMULATION OF LINEAR PROGRAMMING PROBLEM:

The formulation of linear programming problem as a mathematical model involves the following basic steps:

Step 1: Find the key-decision to be made from the study of the solution. (In this connection, looking for variables helps considerably).

Step 2: Identify the variables and assume symbols x_1, x_2, \dots for variable quantities noticed in step 1.

Step 3: Express the possible alternatives mathematically in terms of variables. The set of feasible alternatives generally in the given situation is:

$$[(x_1, x_2); x_1 > 0, x_2 > 0]$$

Step 4: Mention the objective quantitatively and express it as a linear function of variables.

Step 5: Express the constraints also as linear equalities/inequalities in terms of variables.

SOME DEFINITIONS:

(a) Solution:

Values of decision variables x_j ($j = 1, 2, \dots, n$) which satisfy the constraints of a general L.P.P., is called the solution to that L.P.P.

(b) Feasible Solution:

Any solution that also satisfies the non-negative restrictions of the general L.P.P., is called a feasible solution.

**(c) Basic Solution:**

For a set of m simultaneous equations in n unknowns ($n > m$), a solution obtained by setting $(n-m)$ of the variables equal to zero and solving the remaining m equations in m unknowns is called a *basic solution*. Zero variables $(n-m)$ are called *non basic variables* and remaining m are called *basic variables* and constitute a basic solution.

(d) Basic Feasible Solution:

A feasible solution to a general L.P. problem which is also basic solution is called a basic feasible solution.

(e) Optimal Feasible Solution:

Any basic feasible solution which optimize (maximize or minimize) the objective function of a general L.P.P. is called an optimal feasible solution to that L.P. problem.

(f) Degenerate Solution:

A basic solution to the system of equations is called degenerate if one or more of the basic variables become equal to zero.

Limitations of Linear Programming:

Although linear programming is a very useful technique for solving optimization problems, there are certain important limitations in the application of linear programming. Some of these are discussed below:

1. Firstly, the linear programming models can be applied only in those situations where the constraints and the objective function can be stated in terms of linear expressions.
2. In linear programming problems, coefficients in the objective function and the constraint equations must be completely known and they should not change during the period of study.
3. Yet another important limitation of linear programming is that it may give fractional valued answers.
4. Linear programming will fail to give a solution if management have conflicting multiple goals.
5. Linear programming problem requires that the total measure of effectiveness and total resource usage resulting from the joint performance of the activities must equal the respective sums of these quantities resulting from each activity being performed individually.
6. Many real-world problems are so complex, in terms of the number of variables and relationships constrained in them, that they tax the capacity of even the largest computer.
7. Other limitations of LP includes:-
 - Does not take into consideration the effect of time and uncertainty.
 - Parameters appearing in the model are assumed to be constants but in real-life situations they are frequently neither known nor constants.

Illustration 29:

A Chemical Company produces two compounds A and B. The following table gives the units of ingredients C and D per kg of compounds A and B as well as minimum requirements of C and D and costs/kg of A and B. Write down the problem mathematically for minimisation of cost.

		Table Compound		Minimum requirement
		A	B	
Ingredient	C	1	2	80
	D	3	1	75
Cost per kg.		4	6	

**Solution:**

Let x_1 be the no. of units of A

Let x_2 be the no. of units of B

Objective function: $\text{Min. } Z = 4x_1 + 6x_2$

Subject to Constraints:

$x_1 + 2x_2 \geq 8$ (Constraint on requirement of Ingradient C)

$3x_1 + x_2 \geq 75$ (Constraint on requirement of ingradient D)

And $x_1, x_2 \geq 0$ (No negativity constraint)

Illustration 30:

A pension fund manager is considering investing in two shares A and B. It is estimated that:

- (i) Share A will earn a dividend of 12% per annum and share B 4% per annum.
- (ii) Growth in the market value in one year of share A will be 10 paise per Rs.1 invested and in B 40 paise per Rs.1 invested.

He requires investing the minimum total sum which will give:

Dividend income of at least ₹600 per annum and growth in one year of at least ₹1,000 on the initial investment.

You are required to:

State the mathematical formulation of the problem which will facilitate computation of the minimum sum to be invested to meet the manager's objective.

Solution:

Shares	Dividend	Growth in ₹
A	12%	$10/100 = 0.1$
B	4%	$40/100 = 0.4$
Min-income	600	1000

Let x_1 be the amount invested on share A

Let x_2 be the amount invested on share B

Objective function: $\text{Min. } Z = x_1 + x_2$

Subject to constraints:

$0.12 x_1 + 0.04 x_2 \geq 600$ (Dividend income constraint)

$0.1 x_1 + 0.4 x_2 \geq 1000$ (Growth constraint)

And $x_1, x_2 \geq 0$. (Non negativity constraint)

**Illustration 31:**

A company possesses two manufacturing plants each of which can produce three products x, Y and Z from a common raw material. However, the proportions in which the products are produced are different in each plant and so are the plant's operating costs per hour. Data on production per hour costs are given below, together with current orders in hand for each product.

	Product			Operating cost/ hour in ₹
	X	Y	Z	
Plant A	2	4	3	9
Plant B	4	3	2	10
Orders on hand	50	24	60	

You are required to formulate the problem to find the number of production hours needed to fulfill the orders on hand at minimum cost.

Solution:

Let α be no. of hours of plant A in use

Let β be no. of hours of plant B in use

Objective function: $\text{Min } Z = 9\alpha + 10\beta$

Subject to constraints:

$2\alpha + 4\beta \geq 50$ (Constraint relating to Product X)

$4\alpha + 3\beta \geq 24$ (Constraint relating to Product Y)

$3\alpha + 2\beta \geq 60$ (Constraint relating to Product Z)

And $\alpha, \beta \geq 0$ (Non negativity constraint)

Illustration 32:

The products P, Q and R are being produced in a plant having profit margin as ₹ 3, ₹ 5 and ₹ 4 respectively. The raw materials A, B and C are of scarce supply and the availability is limited to 8, 15 and 10 units respectively. Specific consumption is indicated in the table below:

	P	Q	R	Available units
A	2	3	-	8
B	3	2	4	15
C	-	2	5	10
	3/-	5/-	4/-	

Write down the problem mathematically for maximization of profit margin.

Solution:

Let x_1 be the no. of units of product P

Let x_2 be the no. of units of product Q



Let x_3 be the no. of units of product R

Objective function: Max. $Z = 3x_1 + 5x_2 + 4x_3$

Subject to constraints:

$2x_1 + 3x_2 \leq 8$ (Constraint on availability of Raw Material 'A')

$3x_1 + 2x_2 + 4x_3 \leq 15$ (Constraint on availability of Raw Material 'B')

$2x_2 + 5x_3 \leq 10$ (Constraint on availability of Raw Material 'C')

And $x_1, x_2, x_3 \geq 0$ (Non negativity constraint)

Illustration 33:

A Bank is in the process of formulating its loan policy. Involving a maximum of Rs.600 Million. Table below gives the relevant types of loans. Bad debts are not recoverable and produce no interest receive. To meet competition from other Banks the following policy guidelines have been set. At least 40% of the funds must be allocated to the agricultural and commercial loans. Funds allocated to housing must be at least 50% of all loans given to personal, car, Housing. The overall bad debts on all loans may not exceed 0.06.

Formulate a linear program Model to determine optimal loan allocations.

Type of loan	Interest rate %	Bad debts (Probability)
Personal	17	0.10
Car	14	0.07
Housing	11	0.05
Agricultural	10	0.08
Commercial	13	0.06

Solution:

Let x_1 be the amount allocated for personal loan

Let x_2 be the amount allocated for car loan

Let x_3 be the amount allocated for Housing loan

Let x_4 be the amount allocated for agricultural loan

Let x_5 be the amount allocated for Commercial loan

Objective Function: Max Z

$$= 0.17x_1 + 0.14x_2 + 0.11x_3 + 0.1x_4 + 0.13x_5 - (0.10x_1 + 0.07x_2 + 0.05x_3 + 0.08x_4 + 0.06x_5)$$

$$= (0.17 - 0.10)x_1 + (0.14 - 0.07)x_2 + (0.11 - 0.05)x_3 + (0.10 - 0.08)x_4 + (0.13 - 0.06)x_5$$

$$= 0.17x_1 + 0.07x_2 + 0.06x_3 + 0.02x_4 + 0.07x_5$$

Subject to constraints

(i) $x_1 + x_2 + x_3 + x_4 + x_5 \leq 600$ Millions (Constraint on total loan amount)

(ii) $x_4 + x_5 \geq 0.4(x_1 + x_2 + x_3 + x_4 + x_5)$ (Constraint due to policy set for Agricultural and Commercial Loan)

(iii) $x_3 \geq 0.5(x_1 + x_2 + x_3)$ (Constraint due to policy set for Housing Loan)

(iv) $0.1x_1 + 0.07x_2 + 0.05x_3 + 0.08x_4 + 0.06x_5 \leq 0.06$ Million (Constraint on limit of overall bad debt)

(v) $x_1, x_2, x_3, x_4, x_5 \geq 0$ (Non negativity constraint)

**MORE EXAMPLES:****Illustration 34.**

The annual hand-made furniture show and sales occurs next month and the school of vocational studies is planning to make furnitures for sale. There are three wood working classes – I year, II year, III year at the school and they have decided to make three styles of chairs A, B and C. Each chair must receive work in each class and the time in hours for each chair in each class is given.

Chair	I year	II year	III year
A	2	4	3
B	3	3	2
C	2	1	4

In the next month there will be 120 hours available in first year class, 160 hours in the second year class and 100 hours in the third year class to produce chairs. The teacher of the wood working class feels that a maximum of 40 chairs can be sold at the show. The teacher has determined that the profit from each type of chair will be A – ₹40, B – ₹35 and C – ₹30.

Formulate a linear programming model to determine how many chairs should be produced to maximize profit.

Answer:

Let x_1 be the chairs produced of A type

x_2 be the chairs produced of B type

x_3 be the chairs produced of C type

Objective function

$$\text{Maximise } Z = 40x_1 + 35x_2 + 30x_3$$

Subject to constraints:

$$2x_1 + 3x_2 + 2x_3 \leq 120 \text{ (Constraint on available time of 1st year class)}$$

$$4x_1 + 3x_2 + x_3 \leq 160 \text{ (Constraint on available time of 2nd year class)}$$

$$3x_1 + 2x_2 + 4x_3 \leq 100 \text{ (Constraint on available time of 3rd year class)}$$

$$x_1, x_2, x_3 \geq 0 \text{ (Non negativity constraint)}$$

Illustration 35.

A company produces three products P, Q and R from three raw materials A, B and C. One unit of product P requires 2 units of A and 3 units of B. One unit of product Q requires 2 units of B and 5 units of C and one unit of product R requires 3 units of A, 2 units of B and 4 units of C. The company has 8 units of material A, 10 units of material B and 15 units of material C available to it. Profits per unit of products P, Q and R are Rs. 3, Rs. 5 and Rs. 4 respectively.

Formulate the question mathematically to maximize the profit.

Answer:**DATA SUMMARY CHART**

Decision variables	Products	Type of raw material			Profit per unit (₹)
		A	B	C	
x_1	P	2	3	-	3
x_2	Q	-	2	5	5
x_3	R	3	2	4	4
Units of material available:		8 Maximum	10 maximum	15 maximum	



x_1 = number of units of Product P

x_2 = number of units of Product Q

x_3 = number of units of Product R

The given Q. is formulated as the LP model as follows:

$$\text{Maximize } Z = 3x_1 + 5x_2 + 4x_3$$

Subject to the constraints :

$$2x_1 + 3x_3 \leq 8 \text{ (Constraint due to availability of Material A)}$$

$$3x_1 + 2x_2 + 2x_3 \leq 10 \text{ (Constraint due to availability of Material B)}$$

$$5x_2 + 4x_3 \leq 15 \text{ (Constraint due to availability of Material C)}$$

$$x_1, x_2, x_3 \geq 0 \text{ (Non negativity constraint)}$$

Illustration 36.

A city hospital has the following minimal daily requirement for nurses:

Period	Clock time (24 hours day)	Minimal Number of Nurses Required
1	6 a.m. - 10 a.m.	2
2	10 a.m. - 2 p.m.	7
3	2 p.m. - 6 p.m.	75
4	6 p.m. - 10 p.m.	8
5	10 p.m. - 2 a.m.	20
6	2 a.m. - 6 a.m.	6

Nurses report to the hospital at the beginning of each period and work for 8 consecutive hours. The hospital wants to determine the minimal number of nurses to be employed so that there will be sufficient number of nurses available for each period.

Formulate this as a Linear Programming question by setting up appropriate constraints and objective function.

Answer:

$$x_1 + x_3 \geq 15, x_3 + x_4 \geq 8, x_4 + x_5 \geq 20, x_5 + x_6 \geq 6, \text{ and } x_6 + x_1 \geq 2.$$

Since, the objective is to minimize the total number of nurses employed in the hospital,

$$Z = x_1 + x_2 + x_3 + x_4 + x_5 + x_6.$$

Obviously, we must have $x_1, x_2, x_3, x_4, x_5, x_6 \geq 0$.

Illustration 37.

A marketing manager wishes to allocate his annual advertising budget of ₹ 20,000 in two media vehicles A and B. The unit cost of a message in media A is ₹ 1,000 and that of B is ₹ 1,500. Media A is a monthly magazine and not more than one insertion is desired in one issue. At least 5 messages should appear in media B. The expected effective audience for unit messages in the media A is 40,000 and for media B is 55,000.

(i) Develop a mathematical model

**Answer:**

Step 1. The appropriate mathematical formulation of the given Q. is as follows:

$$\text{Maximize (total effective audience) } Z = 40,000 x_1 + 55,000 x_2$$

Subject to the constraints

$$1,000x_1 + 1,500x_2 \leq 20,000 \text{ (Budget constraint)}$$

$$x_1 \leq 12 \text{ (Constraint on annual no. of insertions in Media A)}$$

$$x_1 \geq 5 \quad \text{or} \quad -x_2 \leq -5 \text{ (Constraint on annual no. of insertions in Media B)}$$

$$x_1, x_2 \geq 0 \text{ (Non negativity constraint)}$$

where

x_1 = annual number of insertions/messages for media A.

x_2 = annual number of insertions/ messages for media B.

Illustration 38.

Calculate the standard time per article produced from the following data obtained by a work sampling study:

Total No. of Observations = 2,597

No. of working observations = 2,000

No. of units produced in 100 hours duration = 5,000 numbers

Proportion of manual labour = $\frac{3}{4}$

Proportion of machine time = $\frac{1}{4}$

Observed rating factor = 120%

Total allowances = 15% of normal time

Answer:

Actual working time in the duration of 100 hours = $100 \times (2,000/2,597) = 77.01$ hours

Time taken per article = $(77.01 \times 60) / 5,000 = 0.924$ minute

Observed manual labour time per article = $0.924 \times (3 / 4) = 0.693$ minute

Observed machine time per article = $0.924 \times (1 / 4) = 0.231$ minute

Normal labour time per unit = Observed time / unit \times Rating factor = $0.693 \times 1.20 = 0.8316$ minute

Standard labour time per unit = $0.8316 + (15 / 100) \times 0.8316 = 0.9563$ minute

Standard time per unit of article produced = $0.9563 + 0.231 = 1.19$ minutes.

Illustration 39.

A Company produces the products P, Q and R from three raw materials A, B and C. One unit of product P requires 2 units of A and 3 units of B. A unit of product Q requires 2 units of B and 5 units of C and one unit of product R requires 3 units of A, 2 unit of B and 4 units of C. The Company has 8 units of material A, 10 units of B and 15 units of C available to it. Profits/unit of products P, Q and R are Rs.3, Rs.5 and Rs.4 respectively.

(a) Formulate the problem mathematically,

(b) Write the Dual problem.



Solution:

	x_1	x_2	x_3	
Raw Materials	P	Q	R	Available units
A	2	-	3	8
B	3	2	2	10
C	-	5	4	15
	3	5	4	

Profits 3/- 5/- 4/-

Let x_1 be the no. of units of P

Let x_2 be the no. of units of Q

Let x_3 be the no. of units of R

Objective function: Max. $Z = 3x_1 + 5x_2 + 4x_3$

Subject to constraints:

$2x_1 + 3x_2 \leq 8$ (Constraint on availability of Raw Material 'A')

$3x_1 + 2x_2 + 2x_3 \leq 10$ (Constraint on availability of Raw Material 'B')

$5x_2 + 4x_3 \leq 15$ (Constraint on availability of Raw Material 'C')

And $x_1, x_2, x_3 \geq 0$. (Non negativity constraint)

Primal

Max. $Z = 3x_1 + 5x_2 + 4x_3$

Subject to

$2x_1 + 3x_2 \leq 8$

$3x_1 + 2x_2 + 2x_3 \leq 10$

$5x_2 + 4x_3 \leq 15$

And $x_1, x_2, x_3 \geq 0$

Dual

Min. $Z = 8y_1 + 10y_2 + 15y_3$

Subject to

$2y_1 + 3y_2 \geq 3$

$3y_1 + 2y_2 + 5y_3 \geq 5$

$2y_2 + 4y_3 \geq 4$

And $y_1, y_2, y_3 \geq 0$

$2x_1 + 3x_2 + S_1 = 8$

$3x_1 + 2x_2 + 2x_3 + S_2 = 10$

$5x_2 + 4x_3 + S_3 = 15$

Max $Z = 3x_1 + 5x_2 + 4x_3 + 0.S_1 + 0.S_2 + 0.S_3$

$\therefore x_1 = 23/20 \quad x_2 = 19/10 \quad x_3 = 11/8$

$Z = 18.45$

**Illustration 40.**

Four Products A,B,C and D have ₹ 5, ₹ 7, ₹ 3 and ₹ 0 profitability respectively. First type of material (limited supply of 800 kgs.) is required by A,B,C and D at 4 kgs., 3 kgs, 8 kgs, and 2 kgs. respectively per unit.

Second type of material has a limited supply of 300 kgs. and is for A,B,C and D at 1 kg, 2 kgs, 0 kgs, and 1 kg per unit. Supply of the other type of materials consumed is not limited. Machine hrs. available are 500 hours and the requirements are 8,5,0 and 4 hours for A,B,C and D each per unit.

Labour hours are limited to 900 hours and requirements are 3,2,1 and 5 hours for A,B,C and D respectively.

How should the firm approach so as to maximize its profitability? Formulate this as a linear programming problem. You are not required to solve the LPP.

Solution:

Let x_1 be the no. of units of product A

Let x_2 be the no. of units of product B

Let x_3 be the no. of units of product C

Let x_4 be the no. of units of product D

Objective function Maximize $Z = 5x_1 + 7x_2 + 3x_3 + 9x_4$

	A	B	C	D	Supply in Kgs.
I type material	4	3	8	2	800
II type material	1	2	0	1	300
Machine	8	5	0	4	500
Labour	3	2	1	5	900
Profit	5	7	3	9	

Subject to constraints

$$4x_1 + 3x_2 + 8x_3 + 2x_4 \leq 800 \text{ (Constraint on availability of Material type I)}$$

$$x_1 + 2x_2 + 0.x_3 + x_4 \leq 300 \text{ (Constraint on availability of Material type II)}$$

$$8x_1 + 5x_2 + 0.x_3 + 4x_4 \leq 500 \text{ (Constraint on Machine Hours available)}$$

$$3x_1 + 2x_2 + x_3 + 5x_4 \leq 900 \text{ (Constraint on Labour Hours available)}$$

and $x_1, x_2, x_3, x_4 \geq 0$. (Non negativity constraint)

Illustration 41.

Mutual Fund has cash resources of ₹ 200 million for investment in a diversified portfolio. Table below shows the opportunities available, their estimated annual yields, risk factor and term period details.

Formulate a Linear Program Model to find the optimal portfolio that will maximize return, considering the following policy guidelines:

- All the funds available may be invested
- Weighted average period of at least five years as planning horizon.
- Weighted average risk factor not to exceed 0.20.
- Investment in real estate and speculative stocks to be not more than 25% of the monies invested in total.

Investment type	Annual yield (percentage)	Risk factor	Term period (years)
Bank deposit	9.5	0.02	6
Treasury notes	8.5	0.01	4
Corporate deposit	12.0	0.08	3
Blue-chip stock	15.0	0.25	5
Speculative stocks	32.5	0.45	3
Real estate	35.0	0.40	10

Answer:

Let x_1, x_2, x_3, x_4, x_5 and x_6 represent the six different investment alternatives, i.e., x_1 is bank deposit, x_2 is treasury note, x_3 corporate deposit, x_4 blue chip stock, x_5 speculative stock and x_6 real estate. The objective is to maximize the annual yield of the investors (in number of units) given by the linear expression.

$$\text{Maximize } Z = 9.5x_1 + 8.5x_2 + 12.0x_3 + 15.0x_4 + 32.5x_5 + 35.0x_6$$

Subject to the Constraints:

$$x_1 + x_2 + x_3 + x_4 + x_5 + x_6 \leq 1 \text{ (Investment decision)}$$

$$0.02x_1 + 0.01x_2 + 0.08x_3 + 0.25x_4 + 0.45x_5 + 0.40x_6 \leq 0.20 \text{ (Constraint on weighted average risk of the portfolio)}$$

$$6x_1 + 4x_2 + 3x_3 + 5x_4 + 3x_5 + 10x_6 \geq 5 \text{ (Constraint on weighted average length of period of investment)}$$

$$x_5 + x_6 \leq 0.25 \text{ (Constraint on investment in real estate and speculated stock)}$$

$$x_1, x_2, x_3, x_4, x_5, x_6 \geq 0 \text{ (non-negativity condition)}$$

Illustration 42.

A salesman has to visit five cities A, B, C, D and E. The inter-city distances are tabulated below. Note the distance between two cities need not be same both ways.

From / To	A	B	C	D	E
A	-	12	24	25	15
B	6	--	16	18	7
C	10	11	--	18	12
D	14	17	22	--	16
E	12	13	23	25	--

Note further that the distances are in km.

Required:

If the salesman starts from city A and has to come back to city A, which route would you advise him to take so that total distance traveled by him is minimised?



Solution:

From \ To	A	B	C	D	E
A	-	12	24	25	15
B	6	-	16	18	7
C	10	11	-	18	12
D	14	17	22	-	16
E	12	13	23	25	-

Row Operation*

(Table - 1)

From \ To	A	B	C	D	E
A	-	0	12	13	3
B	0	-	10	12	1
C	0	1	-	8	2
D	0	3	8	-	2
E	0	1	11	13	-

* This matrix is obtained by subtracting minimum element of each row of the given matrix from all the elements of the corresponding row.

Column Operation*

(Table - 2)

From \ To	A	B	C	D	E
A	+	0	4	5	2
B	⊗	-	2	4	0
C	⊗	1	-	0	1
D	⊗	3	0	-	1
E	0	1	3	5	-

* This matrix is obtained by subtracting minimum element of each column of Table-1 from all the elements of the corresponding column.

Here minimum no. of horizontal and vertical straight lines to cover all the zeros = 5 = Order of the matrix.

So the solution is optimal.

Now the solution obtained from the above table shows the travel route of the salesman as A to B, B to E, E to A which means the person is not visiting C and D at all while travelling back to A.

But this is not allowed as per the question.

So the matrix of Table-2 is examined for some of the next best solution which is depicted below.

From \ To	A	B	C	D	E
A	-	0	4	5	2
B	⊗	-	2	4	0
C	0	1	-	⊗	1
D	⊗	3	0	-	1
E	⊗	1	3	5	-

Here the assignments have been started by encircling only zero present in the first row which means initial travel route A to B.



Then the only zero present in the last column is encircled which shows subsequent route B to E. Next the only zero of the last row is not encircled because in that case the route would have been E to A which is restricted as per the given condition. So that element of this row is considered which satisfies the restriction. It is 5 indicating the route as E to D. Next the only zero of 3rd column is encircled which means the route as D to C. Finally the only zero row present in the 3rd row is encircled which shows the route as C to A.

Hence the complete route of the Salesman is : A → B → E → D → C → A

Total distance travelled = 12 + 7 + 25 + 22 + 10 = 76 Kms.

This is the optimum distance.

Illustration 43.

Departmental store wishes to purchase the following quantities of Sprees:

Types of spreess	A	B	C	D	E
Quantity	150	100	75	250	200

Tenders are submitted by 4 different manufacturers who undertake to supply not more than the quantities mentioned below (all types of spreess combined):

Manufacturer	W	X	Y	Z
Total quantity	300	250	150	200

The store estimates that its profit/spreess will vary with the manufacturer as shown in the following matrix.

Manufacturers	Spreess				
	A	B	C	D	E
W	275	350	425	225	150
X	300	325	450	175	100
Y	250	350	475	200	125
Z	325	275	400	250	175

How should the orders be placed?

Solution:

Profit matrix:

	A	B	C	D	E	F	
W	275	350	425	225	150	0	300
X	300	325	450	175	100	0	250
Y	250	350	475	200	125	0	150
Z	325	275	400	250	175	0	200
	150	100	75	250	200	125	



Loss Matrix:

	200	125	50	250	325	475	300/275/225/25
		25		50	200	25	
	175	150	25	300	375	475	250/100/0
150						100	25/25/125/75/5
	225	125	0	275	350	475	150/75/0
		75	75				125* 100*
	150	200	75	225	300	475	200/0
				200			

75/50/50/75/75/75*

<u>150</u>	<u>100</u>	<u>75</u>	<u>250</u>	<u>200</u>	<u>125</u>
0	<u>25</u>	0	<u>50</u>	0	<u>100</u>
	0		0		0
<u>25</u>	<u>0</u>	25	<u>25</u>	<u>25</u>	<u>0</u>
<u>25</u>	<u>0</u>		<u>25</u>	<u>25</u>	<u>0</u>
<u>25</u>	25		<u>25</u>	<u>25</u>	<u>0</u>
25			<u>25</u>	<u>25</u>	<u>0</u>
			<u>25</u>	<u>25</u>	<u>0</u>
			50	50	0

m + n – 1 allocation s are there, optimality test can be performed.

	200	125	50	250	325	475	0
	25	25	50	50	200	25	
	175	150	25	300	375	475	0
150		25	25	50	50	100	
	225	125	0	275	350	475	0
	50	75	75	25	25	0	
	150	200	75	225	300	475	-25
	0	100	100	200	0	25	
175	125	0	250	325	475		



As $\Delta_{ij} \geq 0$, maximum profit is as follows.

		Qty			Maximum Profit
W	→ B	25 x 350	=	8750	
	D	50 x 225	=	11250	
	E	200 x 150	=	30000	
	F	25 x 0	=	0	
X	→ A	150 x 300	=	45000	
	F	100 x 0	=	0	
Y	→ B	75 x 350	=	26250	
	C	75 x 475	=	35625	
Z	→ D	200 x 250	=	50000	
Max. Profit.		900			₹ 2,06,875

Illustration 44.

The Bombay Transport Company has trucks available at four different sites in the following numbers:

Site A	5 Trucks
Site B	10 Trucks
Site C	7 Trucks
Site D	3 Trucks

Customers – W, X and Y require trucks as shown below.

Customer W	5 Trucks
Customer X	8 Trucks
Customer Y	10 Trucks

Variable Costs of getting trucks to the Customers are given below:

From A to W	₹ 7, to X	₹ 3, to Y	₹ 6
From B to W	₹ 4, to X	₹ 6 to Y	₹ 8
From C to W	₹ 5, to X	₹ 8 to Y	₹ 4
From D to W	₹ 8 to X	₹ 4 to Y	₹ 3

Solve the above transportation problem.



Solution:

	7		3		6		0
	4	5	6		8		0
5		3				2	
	5		8		4		0
	8		4		3		0
				7			
					3		
	<u>5</u>		<u>8</u>		<u>10</u>		<u>2</u>

5/0	3	<u>3*</u>	-	-	-
10/8/3/0	4*	2	<u>2*</u>	2	<u>2</u>
7/0	4	1	<u>1</u>	4	-
3/0	3	1	<u>1</u>	<u>1</u>	<u>1</u>

0	<u>3</u>	<u>3</u>	0
1	1	1	0
1	1	1	-
1	2	1	
-	2	1	-
-	2	5	-

	W	X	Y	Z	Ur
A	7		3	6	0
	6	5		4	3
B	4		6	8	0
	5		3	3	2
C	5		8	4	0
	2		3	7	1
D	8		4	3	0
	6		3		1



		W	X	Y	Z	U_i
A		7	3	6	0	-3
		6	5	4	3	
B		4	6	8	0	0
	5		3	3	2	
C		5	8	4	0	-1
		2	3	7	1	
D		8	4	3	0	-2
		6			1	
V_j	4	6	5	0		

As $\Delta_{ij} \geq 0$, the solution is optimum.

Allocation:

			Minimum Cost
A	→	X	→ 5 x 3 = 15
B	→	W	→ 5 x 4 = 20
	→	X	→ 3 x 6 = 18
	→	Z	→ 2 x 0 = 0
C	→	Y	→ 7 x 4 = 28
D	→	Y	→ 3 x 3 = 9
		25	₹ 90

Illustration 45.

A company has 3 plants located at different places but producing an identical product. The cost of production, distribution cost of each plant to the 3 different warehouses, the sale price at each warehouse and the individual capacities for both the plant and warehouse are given below:

Plants	F1	F2	F3		
Raw material	15	18	14		
Other expenses	10	9	12		
Distribution cost to warehouse				Sales Price in (₹)	Warehouse Capacity (No)
W1	3	9	5	34	80
W2	1	7	4	32	110
W3	5	8	3	31	150
Capacity of Plant (No.)	150	100	130		



Establish a suitable table giving net profit/loss for a unit produced at different plants and distributed at different locations.

- (b) Introduce a suitable dummy warehouse / plant so as to match the capacities of plants and warehouses.
- (c) Find distribution pattern so as to maximise profit / minimise loss.
- (d) Interpret zero value of square evaluation of an empty cell and find alternative solutions.

Solution:

Profit matrix

	6	-2	3	80
	6	-2	2	110
	1	-4	2	150
	0	0	0	40
150	100	130		380

Loss Matrix:

	0	8	3	80/40/0	3/3/5
40		40		110/0	4*
	0	8	4	150/20/0	1/1/6*
	5	10	4	40/0	0/0/0
	6	6	6		
	40				
150	100	130			
40	0	0			
0					
0	2	1			
5*	2	1			
	2	1			



40	0	40	8	3	U
				1	0
110	0		8	4	0
			0	2	
	5		10	4	2
	3	20		130	
	6		6	6	-2
	4	40		6	
	0	8	2		

As there are $m+n-1$ allocations, optimality test can be performed since $\Delta_{ij} \geq 0$,

		Quantity	Maximum Profit
F1	W1	40 x 6	240
	W2	40 x -2	-80
F2	W1	110 x 6	660
F3	W2	20 x -4	-80
	W3	130 x 2	260
F4 Dummy	W2	40 x 0	0
		380	Rs. 1000

Profit ₹ 1,000/-

Illustration 46.

The Tit-Fit Scientific Laboratories is engaged in producing different types of high class equipment for use in science laboratories. The company has two different assembly lines to produce its most popular product 'Pressure'. The processing time for each of the assembly lines is regarded as a random variable and is described by the following distributions.

Process Time (minutes)	Assembly A1	Assembly A2
10	0.10	0.20
11	0.15	0.40
12	0.40	0.20
13	0.25	0.15
14	0.10	0.05

Using the following random numbers, generate data on the process times for 15 units of the item and compute the expected process time for the product. For the purpose, read the numbers vertically taking the first two digits for the processing time on assembly A1 and the last two digits for processing time on assembly A2.



4134	8343	3602	7505	7428
7476	1183	9445	0089	3424
4943	1915	5415	0880	9309

In the first stage, we assign random number intervals to the processing times on each of the assemblies.

Solution:

Computation of Random Interval for Processing Time

Process time Minutes	A1			A2		
	P _i	∑P _i	Range	P _i	∑P _i	Range
10	0.10	0.10	0-9	0.20	0.20	0-19
11	0.15	0.25	10-24	0.10	0.60	20-59
12	0.40	0.65	25-64	0.20	0.80	60-79
13	0.25	0.90	65-89	0.15	.095	80-94
14	0.10	1.00	90-99	0.05	1.00	95-99

Simulated date for 15 units

	Random No.	Process Time	Random No.	Process Time	Total
1	41	12	34	11	23
2	74	13	76	12	25
3	49	12	43	11	23
4	83	13	43	11	24
5	11	11	83	13	24
6	11	11	83	13	24
7	36	12	02	10	22
8	94	14	45	11	25
9	54	12	15	10	22
10	75	13	05	10	23
11	00	10	89	13	23
12	08	10	80	13	23
13	74	13	28	11	24
14	34	12	24	11	23
15	93	14	09	10	24
		182		167	349

Average Process time for

$$A1 = 182/15 = 12.13 \text{ Minutes}$$

$$A2 = 167/15 = 11.13 \text{ Minutes}$$



For product = $349/15 = 23.27$ Minutes

Expected process time for the product = 23.27 minutes (12 .13 + 11.13)

Illustration 47.

A businessman is considering taking over a certain new business. Based on past information and his own knowledge of the business, he works out the probability distribution of the monthly costs and sales revenues, as given here:

Cost (in ₹)	Probability	Sales Revenue (₹)	Probability
17000	0.10	19000	0.10
18000	0.10	20000	0.10
19000	0.40	21000	0.20
20000	0.20	22000	0.40
21000	0.20	23000	0.15
		24000	0.05

Use the following sequences of random numbers to be used for estimating costs and revenues. Obtain the probability distribution of the monthly net revenue.

Sequence 1	82	84	28	82	36	92	73	91	63	29
	27	26	92	63	83	02	10	39	10	10
Sequence 2	39	72	38	29	71	83	19	72	92	59
	49	39	72	94	04	92	72	18	09	00

b. Repeat the analysis in (a) by using the following random number streams:

Sequence 1	20	63	46	16	45	41	44	66	87	26
	78	40	29	92	21	36	57	03	28	08
Sequence 2	23	57	99	84	51	29	41	11	66	30
	41	80	62	74	64	26	41	40	97	15

Solution:

Cost (₹)	Probability	Cumulative Probability	Random Range	Cost (₹)	Probability	Cumulative Probability	Random Range
17000	0.1	0.1	00-09	19000	0.1	0.1	00-09
18000	0.1	0.2	10-19	20000	0.1	0.2	10-19
19000	0.4	0.6	20-59	21000	0.2	0.4	20-39
20000	0.2	0.8	60-79	22000	0.4	0.8	40-79
21000	0.2	1.0	80-99	23000	0.15	0.95	80-94
				24000	0.05	1.00	95-99



Month	Random No. for Cost	Cost (₹)	Random No. for Sales	Cost (₹)	Monthly Net Revenue (₹)
1	82	21000	39	21000	-
2	84	21000	72	22000	1000
3	28	19000	38	21000	2000
4	82	21000	29	21000	-
5	36	19000	71	22000	3000
6	92	21000	83	23000	2000
7	73	20000	19	20000	-
8	91	21000	72	22000	1000
9	63	20000	92	23000	3000
10	29	19000	59	22000	3000
11	27	19000	49	22000	3000
12	26	19000	39	21000	2000
13	92	21000	72	22000	1000
14	63	20000	94	23000	3000
15	83	21000	04	19000	(2000)
16	02	17000	92	23000	6000
17	10	18000	72	22000	4000
18	39	19000	18	20000	1000
19	10	18000	09	19000	1000
20	10	18000	00	19000	1000
					35000

Average = $35000/20 = ₹1750$.



Study Note - 5

PRODUCTIVITY MANAGEMENT AND QUALITY MANAGEMENT



This Study Note includes

- 5.1 Measurement Techniques of Productivity Index
- 5.2 TQM Basic Tools and Certification
- 5.3 ISO Standard Basics

5.1 MEASUREMENT TECHNIQUES OF PRODUCTIVITY INDEX

Productivity implies development of an attitude of mind and a constant urge to find better, cheaper, quicker, easier and safe ways of doing a job, which could be either manufacturing an article or providing a service. Since the beginning of the industrial era, the manufacturers or producers have been facing the problem of how to use the available resources and factors of production to the best of their ability and capacity so as to get the maximum output with the minimum cost of production. Industrial revolution, social, technological and scientific developments, changes in economic systems are the various efforts made in this direction and the process of development and changes is still on. New and new machines, methods and technology are being invented and used in the industrial field to minimise the wastage of men, materials and machines. It is all to increase the productivity.

Productivity is the quality or state of being productive. It is some relationship of outputs to inputs. It is a concept that guides the management of a production system, and measures its success. It is the quality that indicates how well labour, capital, materials and energy are utilised. Productivity improvement is sought everywhere because it supports a higher standard of living, helps control inflation, and contributes towards a stronger national economy.

Productivity is an indicator reflecting the changes in the performance of the enterprise and having some sort of input-output comparisons relating to various activities of an organisation. It also facilitates the management to control and plan the future operations of the enterprise.

Productivity is the talk of the day and it is generally regarded as efficiency in industrial production to be measured by some relationship between outputs and inputs. The increase in productivity is looked upon as the key to prosperity at all levels. In its modern sense, it refers to the relationship between the result and the means employed or to be more specific between the product and the factors used for obtaining it. It is the quantitative relationship between what we produce and the resources which we use to obtain it. It can also be termed as the ratio of what is produced to what is required to produce it. The higher is the ratio, the greater is the productivity. Thus, it seeks to measure the economic soundness of the use of the means. It means productivity can be considered higher if the same amount of production is obtained with lesser means or it will be lower if the same quantity of production is obtained with larger quantity of means. It is higher when there is maximum production with the least expense of resources.

A productivity index is a device of expressing the ratio between outputs and the inputs of the resources numerically. These indices are prepared by comparing the volume of output of goods with the labour employed on that job or the profits of the firm with the capital employed. If the comparison shows an upward trend in indices, it is a sign of improved or better productivity and vice-versa.

The productivity is a measure of how much input is required to achieve a given output.

Symbolically:

$$P = \frac{O}{I} \text{ where}$$

P = Productivity;
 O = Output,
 I = Input.



The output may be measured in terms of the units of goods produced or the value of goods and services produced. The input, on the other hand, can be referred to as the combination of different factors, i.e., raw materials, machinery, worker's time, power, efforts and imagination of entrepreneur and the managers. A unit of input, therefore, can be expressed as one worker, or one hour of labour time or one tonne of raw materials, or one kw of electricity and so on. Thus, it is very clear from the above description that the productivity can be calculated or measured for each one of the factors comprising of the input or of all the factors together. The productivity of labour, for example, can be found out by ascertaining the ratio between the quantity of goods produced and the number of workers or man-hours employed on the production of such output.

The importance of the concept of productivity can be viewed from the following points:

1. **To beat the competition:** It is an age of cut-throat competition. There may be other commodities which can serve as the substitutes of the terms 'product' and can attract the consumers' purchasing power. The firm whose productivity is higher can only beat the competition and can exist in the market for long.
2. **Guide to Management:** The productivity indices are very useful for the management and can be used for different purposes. These indices can serve as a valuable guide to the management for improving the performance of its enterprise. The productivity measures can be used for the following purposes:
 - (a) **Strategic:** With the help of productivity indices, the efficiency of different firms can be measured, analysed and compared. The necessary steps can be taken to improve the productiveness of the firm taking in view the productiveness of the other competitive firms.
 - (b) **Tactical:** Different units or the sectors of the firm can also be compared as regards to their productivity and the productivity of the less productive units or sectors can be improved.
 - (c) **Planning:** A firm uses different inputs in producing the goods. A comparison of relative benefits accruing from the use of different inputs can be had and the most beneficial input can be used in production. It helps the management to plan for the future.
 - (d) **Administration:** Productivity indices indicate the progress of the firm over a period of years. The productivity of different inputs, including labour, can be measured individually. The individual productivity indices help the management in bargaining with the labour leaders, trade unions and the Government in case of labour disputes regarding welfare activities. Thus administration can be improved with the help of productivity indices.
3. **An Indicator of Progress:** In economically backward countries, productivity movement is basic aspect of progress. It implies the development of an attitude of mind and a constant urge to better, cheaper, quicker and safer ways of doing a job which could be either manufacturing a product or providing a service. In an urge to improve the productivity, new inventions take place. Thus productivity is an aspect of basic progress.
4. **Maximum utilisation of Scarce Resources:** In order to provide the articles or commodities to the consumers at the lowest possible cost, the productivity urges to utilise the available resources to the maximum possible extent to provide full satisfaction of customers. The productivity processes and techniques are designed to facilitate more efficient work involving less fatigue to workers by improvements in the layout of the plant and work, better working environment and simplification of works.
5. **Key to National Prosperity:** The productivity, in fact, has become the synonymous to progress. Higher productivity is an index of more production with the same inputs at lower cost. It enables industry to offer goods to the general public at cheaper rates and results in expansion of markets. The working conditions and wages of workers will improve and industrialists too will get larger profits. Thus higher productivity is the key to national prosperity. The secrets of Japan and Western countries' prosperity lie in increased productivity.
6. **Prosperity to Labour:** The higher productivity is a boon to labour also. It brings improved working conditions, better wages and salaries to workers, better labour welfare activities to labourers. Thus their standard of living is improved.
7. **Other Uses:**
 - (i) Higher productivity increases the profits and reserve funds of the industry that can be used for expansion and modernisation.
 - (ii) It increases the goodwill of the firm due to cheaper goods to the public, well-off staff and more profits and better financial position.



- (iii) It improves the competitive strength of the company in export markets through reduction in cost of production and quality products.

In this way, productivity is the only way to make the overall progress of the country.

Measurement of Productivity: The productivity or the performance of various input and output factors can be measured in many ways. These measures are mainly based on the following two criteria:

- (i) **Change in output per unit of input:** indicates the change in the performance of corresponding input during the given period, e.g., change in output per worker or per man-hour will signify the change in performance of labour.
- (ii) **Change in input per unit of output:** during the given period signifies the change in the performance of the corresponding input factor, e.g., change in man-hour or workers' per unit of output will also indicate the change in the performance of the labour input.

Productivity measurement implies the use of standards set for each input factor in terms of output. In circumstances where standards are not in use, productivity can be measured only when the output is converted into 'units or work' which is defined as the amount of work that can be performed by one unit of input. Thus productivity can be measured by dividing the output by the performance of each input factor taken together.

Some of the well-known indices of productivity are given below:

- (A) **Man-hour output:** The most widely used index of productivity is to work out the output per man-hour it can be put as –

Productivity = Units of output / Total man-hours

- (B) **Productivity Ratio:** The rate of return on capital employed is a valuable and widely used guide to many types of business decisions. This ratio of profit to capital employed is a valuable means of measuring the performance of divisions, sections, plants, products and other components of a business, and can be calculated as—

Productivity = Net Profit / Capital employed

- (C) **Use of Financial Ratios:** There are many situations when time standards cannot be set and therefore, it is very difficult in such cases to measure the productivity by a direct method. In these cases, financial ratios can be used to measure the productivity by using its sales turn-over. But 'added value' is a more useful approach for measuring productivity. 'Added value' means output - inputs.

The most common financial ratio of productivity is—

Productivity = Added Value / Labour Costs

Productivity = Added Value / Conversion Costs

The first ratio gives the financial productivity of labour force and the second ratio gives the financial productivity of all the resources of the company put together.

- (D) **Other Useful Measures:** There are many other useful productivity ratios to measure the productivity of various input factors. These are:

$$(i) \text{ Manpower Productivity} = \frac{\text{Value of output of goods or services}}{\text{No. of workers or man hours used}}$$

$$(ii) \text{ Materials Productivity} = \frac{\text{Value of output of goods or services}}{\text{Units (or cost) of materials used}}$$

$$(iii) \text{ Capital Productivity} = \frac{\text{Value of output of goods or services}}{\text{Capital assets employed}}$$

$$(iv) \text{ Energy Productivity} = \frac{\text{Value of output of goods or services}}{\text{Units (or cost) of energy used}}$$



A combined measure of productivity can be taken as

$$\text{Productivity} = \frac{\text{Value of output of goods or services}}{\text{Values of (labour + capital + materials + others inputs)}}$$

There may be other input factors such as insurance, taxes, advertising etc. and their productivity can be measured likewise.

Each measure requires different kinds of data and only rarely such information is available for all commodities in an industry on continuous basis.

Tools of productivity or how to increase productivity:

The productivity of an enterprise can be improved by improving the performance of various inputs and other factors affecting productivity. For this purpose, use of following tools can be recommended.

1. Human Aspects: Under this, cooperation of workers is sought in the following ways:

- (i) More workers' participation in management or in decision making through joint consultation.
- (ii) Improving communication services.
- (iii) Improving mutual trust and cooperation through improved job procedures, better training of employees, more workers incentives by implementing various incentive schemes, and labour welfare programmes.
- (iv) Better planning of work, more effective management, more democracy in administration, improved human relations and selection and training of personnel at various levels of management are some human efforts from the side of management in order to improve the productivity.

2. Supply of Inputs:

- (i) Improvement in the nature and quality of raw materials and their supplies to the work.
- (ii) Proper provision of plant, equipment and their maintenance.
- (iii) Introduction of more and more machines and equipment in place of physical work.
- (iv) Fuller utilisation of manpower and efficiency or capacity of plant and equipment employed.

3. Technological Aspects:

Certain methodological and technological developments are also necessary to improve the productivity of the concern.

These are;

- (i) Work, time and motion studies to determine better ways and means of doing a job.
- (ii) Implementing various simplification, specialisation and standardisation programmes.
- (iii) Applying control techniques comprising of production and planning control, cost control and quality control techniques.
- (iv) Improving layout of plants, shops and machine tools, and material handling and internal transportation system.
- (v) Improving inspection techniques so as to minimise the wastage and defective work.

Factors affecting industrial productivity:

Productivity is defined to be some ratio between output and input. Thus all factors which affect output and inputs will also affect the measure of productivity.

The following factors affect the productivity.

1. Technological Development: Technical factors including the degree of mechanisation, technical know-how, raw materials, layout and the methods and techniques of work determine the level of



technological development in any industry. The principal factors in technological development affecting productivity are:

- (a) **The Size of the Plant:** The size of the plant and the capacity utilisation has direct bearing on productivity. Production below or above the optimum level will be uneconomical and will tend towards lower level of productivity.
- (b) **Research and Development:** Investment in research and development may yield better method of work and better design and quality of products.
- (c) **Plant and Job Layout:** The arrangement of machines and positions in the plant and the set-up of the work-bench of an individual worker will determine, how economically and efficiently production will be carried out.
- (d) **Machine and Equipment Design:** Whether the design of machinery and equipment is modern and in keeping with the limitations and capacities of the workers will also determine the production efficiency and level of productivity.
- (e) **Production Processes:** Advanced production processes involving the use of modern integrated and automatic machinery and semi-processed materials have been known to help in raising levels of productivity.
- (f) **Power, Raw Materials etc.** Improved quality of raw materials and increased use of power have a favourable effect on productivity.
- (g) **Scientific Management Techniques:** Scientific management techniques such as better planning of work, simplification of methods, time and motion study, emphasis for reduced wastage and spoilage have positive effects on productivity.

It will be realised that technological development requires a great amount of funds and general economic and technical environment in the country. Thus capital plays an important role in increasing the productivity through implementing technological development. It should also be recognised that such developments influence the job performance of employees. With better machines, tools and processes, it should be considered that both ability and willingness to work should be increased.

2. **Individual Factors:** Individual factors such as knowledge, skill and attitude also affect the productivity of industry. Knowledge is acquired through training, education and interest on the part of learner. Skill is affected by aptitude (one's capacity to learn a particular kind of work), personality (emotional maturity, balance of mind etc.) as also by education, experience, training etc. Increased knowledge, skill and aptitude certainly increased the productivity and a person deficient in these personal attributes is less productive than an average man.

The attitude (willingness of employee to work for organisation) of employees towards the work and the organisation affect their productivity to a great extent. Knowledge and skill without willingness are futile. The urge to work is a complex phenomenon governed by several factors such as formal and informal organisation, leadership, need, satisfaction, influence of trade unions etc. These factors motivate the workers to work better and with enthusiasm.

3. **Organisation Factors:** Organisation factors include various steps taken by the organisation towards maintaining better industrial relations such as delegation and decentralisation of authority, participative management (workers' participation in management), organisational efficiency, proper, personnel policies relating to selection, placement, promotion, wage salary levels, incentives, merit rating, job evaluation, training and provision for two-way communication, supervision, etc. These factors also influence motivation. Likewise the existence of groups with higher productivity as their goal is likely to contribute to the organisational objectives. These facts were brought out by Hawthorne experiments in U.S.A. A properly-motivated worker will certainly contribute to the industrial productivity.
4. **Work Environment:** The importance of proper work environment and physical conditions on the job has been emphasised by industrial psychologists and human engineers. Better work environment ensures the greatest ease at work through better ventilation and light arrangement, improved safety devices, reduction in noise, introducing suitable rest-pause etc.



5. **Other factors:** There are several other factors that affect productivity. These are:
- (a) **Natural Factors:** Physical, geographical and climatic conditions influence the productivity at large. Abundance of natural resources affects the productivity and similarly climate affects the efficiency of workers to a great extent.
 - (b) **Managerial Factors:** The industrial productivity is influenced very much through managerial ability and leadership. The managerial ability of utilising the available resources to the maximum, organising capacity, foresightedness, decision-making ability and entrepreneurship are certain factors that contribute to productivity.
 - (c) **Government Policy:** Government policies towards industry also contribute to industrial productivity. Taxation policy, financial and administrative policy, tariff policy and protection policy affect the productivity to a large extent.

Thus, the above factors are responsible for the increased productivity.

Production and Productivity:

Production and productivity are not synonymous. Production refers to the volume, value or quantity of goods and services produced during a given period by a worker, plant, firm or economy. It is the sum total of results achieved by the various factors used together. Productivity, on the other hand, is not concerned with the volume of production. It is the ratio of output and input factors of an enterprise. It shows the efficiency of production or the efficiency level of input factors. In other words, productivity is relative to the resources used in turning out a certain amount of physical output, while production is used, more or less, in absolute sense. The distinction between these two terms becomes more clear when we find that increase in production does not necessarily mean the increase in productivity. If increase in production is attributed to the increase in the inputs of production in the same proportion, the production will have increased but productivity may have declined or may remain constant because the ratio of output and inputs has shown a decline or has not shown any improvement.

Illustration 1.

In a particular plant there are 10 workers manufacturing a single product and the output per month consisting of 25 days of that particular product is 200. How much is the monthly productivity?

Solution:

Monthly productivity per worker = $\frac{200}{10} = 20$ units

Illustration 2.

There are two industries A and B manufacturing hose couplings. The standard time per piece is 15 minutes. The output of two small scale industries is 30 and 20 respectively per shift of 8 hours. Find the productivity of each per shift of 8 hours. What is the expected production of each per week consisting of 6 days?

Solution:

Productivity = $\frac{\text{Actual production}}{\text{Standard production}}$

Standard production of hose couplings per shift = $\frac{8 \times 60}{15} = 32$ pcs.

Productivity of industry A = $\frac{30}{32} = \frac{15}{16}$ and productivity of industry B = $\frac{20}{32} = \frac{5}{8}$

If the productivity is expressed in percentage, the same for A is $\frac{15}{16} \times 100 = 93.75\%$

and productivity of industry B is $\frac{5}{8} \times 100 = 62.5\%$

Production per week of industry A = $30 \times 6 = 180$ nos. (Assuming the industry to work for one shift per day)

Production per week of industry B = $20 \times 6 = 120$ nos. (Assuming the industry to work for one shift per day)

**Illustration 3.**

The following data is available for a machine in a manufacturing unit:

Hours worked per day	8
Working days per month	25
Number of operators	1
Standard minutes per unit of production	
Machine time	22
Operator time	8
Total time per unit	30

- (i) If plant is operated at 75% efficiency, and the operator is working at 100% efficiency, what is the output per month?
- (ii) If machine productivity is increased by 10% over the existing level, what will be the output per month?
- (iii) If operator efficiency is reduced by 20% over the existing level, what will be the output per month?

Solution:

- (a) Hours worked per day = 8
 Working days per month = 25
 Hours worked per month = $25 \times 8 = 200$ hrs.
 Machine time = 22 minutes
 Operator time = 8 minutes
 Total time per unit = 30 minutes = $\frac{1}{2}$ hr.

$$\text{No. of units that can be produced/month/operator} = \frac{200}{1/2} = 400$$

As the no. of operator is 1, possible monthly production = 400 units. As the plant operates at 75% efficiency.

$$\text{Monthly production} = 400 \times \frac{75}{100} = 300 \text{ units.}$$

- (b) If machine productivity is increased by 10% i.e. Machine time = $22 \times \frac{100}{(100+10)} = 20$ minutes.

Then, total time = $20 + 8 = 28$ minutes

$$\text{Monthly production} = \frac{400 \times 30}{28} \times \frac{75}{100} = 321 \text{ units.}$$

- (c) If operator efficiency reduced by 20% i.e.

$$\text{Operator time} = 8 \times \frac{(100+20)}{100} = 8 \times 1.2 = 9.6 \text{ minutes.}$$

Total time = $22 + 9.6 = 31.6$ minutes.

$$\text{Monthly production} = \frac{400 \times 30}{31.6} \times \frac{75}{100} = 284 \text{ units.}$$

(Efficiency reduced by 20%. Instead of 100%, now 80% job is completed in 8 minutes. That means, operators time is increased to 10 minutes)

**Illustration 4.**

The following data is available for a manufacturing unit :

No. of operators	:	15
Daily working hours	:	8
No. of days per month	:	25
Std. production per month	:	300 units
Std. Labour hours per unit	:	8

The following information was obtained for November 2015:

Man days lost due to absentism	:	30
Unit produced	:	240
Idle Time	:	276 man hours

Find the following:—

- Percent absentism
- Efficiency of utilisation of labour
- Productive efficiency of labour
- Overall productivity of labour in terms of units produced per man per month.

Solution:

$$\begin{aligned} \text{No. of days per month} &= 25 \\ \text{Daily working hrs.} &= 8 \\ \text{No. of operators} &= 15 \\ \text{No. of Man days per month} &= 15 \times 25 = 375 \text{ Man days.} \\ \text{Total working hrs. per month} &= 375 \times 8 = 3,000 \\ \text{Hours lost in absentism in a month} &= 30 \times 8 = 240 \\ \text{(a) Percent absentism} &= \frac{240 \text{ hrs.} \times 100}{3000 \text{ hrs}} = 8\% \\ \text{(b) Efficiency of utilisation of labour} &= \frac{\text{Standard labour hour to produce 240 units}}{\text{Total labour hour}} \times 100 \\ &= \frac{240 \times 8}{3000} \times 100 = 64\% \\ \text{(c) Standard time required to produce 240 units} &= 240 \times 8 = 1920 \text{ labour-hours.} \\ \text{In November, man hours lost} &= 30 \times 8 = 240 \\ \text{,, ,, idle time (in hours)} &= 276 \\ \text{Total loss of time} &= 516 \text{ hours.} \\ \text{Productive hours available in November} &= 3000 \\ \text{Less, Total loss of time} &= 516 \\ \text{Actual labour-hours} &= 2484 \text{ hours} \\ \text{Efficiency of labour} &= \frac{\text{Std. Labour hrs.}}{\text{Actual Labour hrs.}} = \frac{1920 \times 100}{2484} = 77.3\% \end{aligned}$$



- (d) 15 men produces 300 units,
 Std. labour productivity = $300/15 = 20$ units.
 In November, overall productivity = $240/15 = 16$ units. (Ans.)
 i.e. productivity falls by 25%.

Illustration 5.

An incentive scheme allows proportionate production bonus beyond 100% performance level. Calculate the amount of (i) Incentive bonus and (ii) Total payment received by an operator on a particular day during which the following particulars apply:

Operation	:	Assembling pocket transistor radio set
Work Content	:	30 Standard minutes per assembled set
Attended Time	:	8 Hours
Time spent on unmeasured work	:	2 Hours
Numbers of sets assembled during the day	:	15
Wage rate	:	₹ 4 per hour

- (iii) What is the net labour productivity achieved by the operator during the day?

Solution:

Total standard minutes worked during the day = $30 \times 15 = 450$, working time = $8 - 2 = 6$ hours = 360 minutes.
 Performance = $(450 \times 100) / 360 = 125\%$ i.e incentive is payable on 25% which is above 100%

- (i) Incentive bonus = $0.25 \times 6 \times 4 = ₹ 6$ for six hours on measured work
 (ii) Guaranteed wage for 8 hours = $8 \times 4 = ₹ 32$; Total earnings for the days
 = ₹ $(6 + 32) = ₹ 38$
 (iii) Net labour productivity = Output in units / Net man hours = $15 / 6 = 2.5$ sets per hour.

5.2 TQM BASIC TOOLS AND CERTIFICATION

What is Total Quality Management (TQM)?

A **philosophy** that **involves everyone** in an organisation in a **continual effort** to **improve quality** and achieve **customer satisfaction**.

Basic Concepts in TQM

1. Top management commitment and support.
2. Focus on both internal and external customers.
3. Employee involvement and empowerment.
4. Continuous improvement (KAIZEN)
5. Partnership with suppliers
6. Establishing performance measures for processes.



Essentials of TQM Focus

1. Customer satisfaction
2. Leadership
3. Quality policy
4. Organisation structure
5. Employee involvement
6. Quality costs
7. Supplier selection and development
8. Recognition and reward.

Underlying Principles in TQM

1. Strive for quality in all things (Total Quality)
2. The customer is the creation of quality
3. Improve the process or systems by which products are produced
4. Quality improvement is continuous, never ending activity (continuous improvement-Kaizen)
5. Worker involvement is essential
6. Ground decisions and actions on knowledge
7. Encourage team work and cooperation.

Scope of TQM

1. An integrated organisational infrastructure
2. A set of management practices
3. A wide variety of tools and techniques.

TQM is Japanese approach to quality. The term TQM refers to a quest-for quality in an organization. TQM is a process that underlines three philosophies. *One* is never-ending push to improve, which is referred to as *continuous improvement*; the *second* is the involvement of every employee in the organization and the *third* is the goal for *customer satisfaction*, which means meeting or exceeding customer expectations. It often focuses on benchmarking world-class standards, product and service design and purchasing. In addition, TQM involves a number of other elements such as:

- Team approach,
- Employee empowerment
- Decisions based on facts rather than opinions,
- Knowledge of quality tools [flow charts, check sheets, histograms, pareto analysis, scatter diagrams etc.]
- Quality at the source and
- Inclusion of suppliers as a part of quality improvement programme.

TQM is a process of continuous improvement at every level of the organization-the centre of the entire process is customer satisfaction. TQM implies that the organization is doing everything it can to achieve quality at all stages of the process, from customer demands, to product design, to engineering.



TQM seeks to breakdown communication barriers among employees and also between the organization and its external stakeholders, in order to increase cross-functional integration and provide new avenues for co-operation to improve quality. It would be incorrect to think of TQM merely a collection of techniques. Rather, TQM reflects a whole new attitude toward quality. It is about the *culture* of an organization. To truly reap the benefits of TQM, the culture of an organizations must change. In other words, TQM organization strives to develop co-operative relationships with its suppliers and distributors so that continuous improvement of quality becomes their goals too. Ford, Motorola, and GM have taken steps to develop long-term relationships with their suppliers and distributors.

5.3 ISO STANDARD BASICS

Quality Certification

Many international businesses recognize the importance of quality certification. The EU, in 1987, established ISO [International Organisation for Standardisation] 9000 certification. Two of the most well known of these are ISO 9000 and ISO 14,000. ISO 9000 pertains to quality management. It concerns what an organization does to ensure that its products or services are suitable to customers expectations. ISO 14,000 concerns minimization of harmful effects to the environment caused by its operations. Both ISO 9000 and ISO 14000 are related to an organization processes rather than its products and services and they stress continual improvement.

ISO 9000 is composed of the national standard bodies of 91 countries. About 90 countries have adopted ISO 9000 as national standards. This certification is intended to promote the idea of quality at every level in the organisation.

ISO certification is an elaborate and expensive process. Any firm seeking this certification needs to document how its workers perform every function that affects quality and install mechanisms to ensure that, they follow on expected lines. ISO 9000 certification entails a complex analysis of management systems and procedures. Rather than judging the quality of a particular product, ISO 9000 evaluates the management of the entire manufacturing process, from purchasing, to design, to training. A firm that seeks this certification must fill out a report and then be certified by a team of independent auditors. With certification comes *registration* in an ISO directory, that firms seeking suppliers can refer to, for a list of certified companies. They are generally given preference over unregistered companies.

There are essentially five standards associated with the ISO 9000 series. The series, if we place them on a continuum, would range from design and development through procurement, production, installation and servicing. Whereas, ISO 9004 only establishes guidelines for operation, ISO 9001, 9002 and 9003 are well-defined standards.

Quality System

9001 Model for Quality Assurance in Design, Production, Installation and Servicing. (To be used when conformance to specified requirements is to be assured by the supplier during several stages that may include design/development, production, installation and servicing).

9002 Model for Quality Assurance in Production and Installation. (To be used when conformance to specified requirements is to be assured by the supplier during production and installation).

9003 Model for Quality Assurance in Final Inspection Test. (To be used when conformance to specified requirements is to be assured by the supplier solely at final inspection and test).

Guidelines for Use

9000 Quality Management and Quality Assurance Standards - Guidelines for Selection and Use.

9004 Quality Management and Quality System Elements - Guidelines.

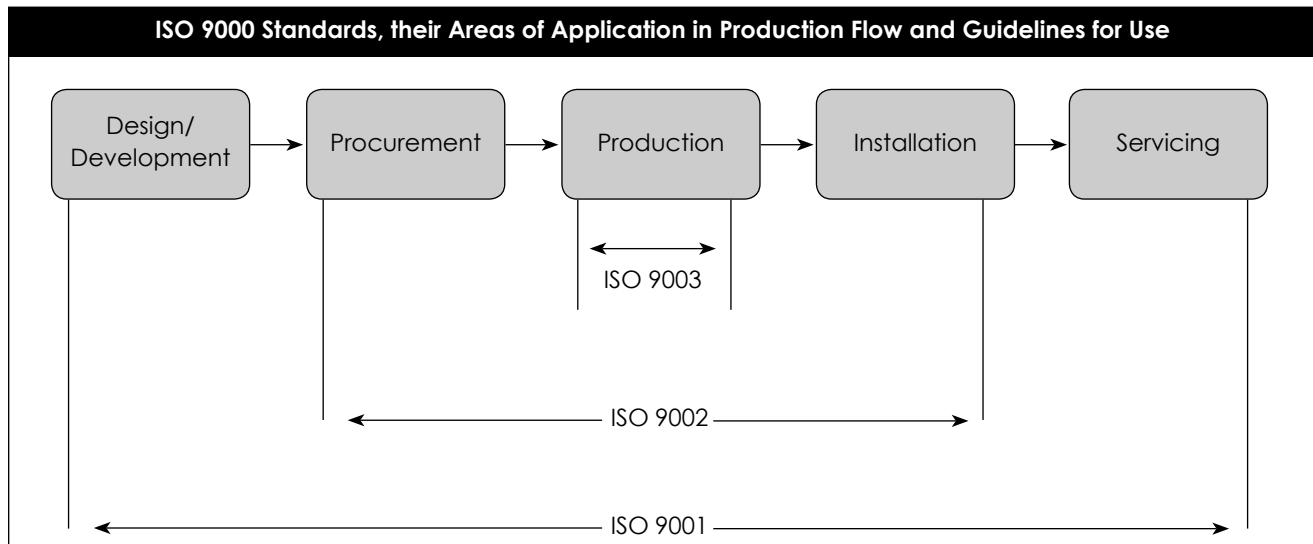

ISO certification is a must for doing business with any member of the EU. In addition to the benefits of accessing the EU, ISO 9000 certification and registration is particularly helpful for companies that do not currently have a quality management system, as it provides guidelines for establishing the system and making it effective. The latest version of ISO 9000 forms the basis of eight quality management principles.

1. A system approach to management
2. Continual improvement
3. Factual approach to decision making
4. Mutually beneficial supplier relationships
5. Customer focus
6. Leadership
7. People involvement
8. Process approach.

ISO standards are reviewed every five years and revised if needed. This helps ensure they remain useful tools for market place. The challenges faced by business and organisations today are very different from few decades ago and ISO 9001 has been updated to take this new environment into account.

The last version was ISO 9001:2008 and has been replaced by further updated version ISO 9001:2015 on and from September 2018.

SOME MORE EXAMPLE:

Illustration 6.

Compute the productivity per machine hour with the following data. Also draw your interpretation.

Month	No. of machines employed	Working hours	Production Units
January	400	220	99,000
February	550	180	1,00,000
March	580	220	1,25,000

**Answer:**

Month	No. of machines employed	Working hours	Machine hours	Production Units
January	400	220	88,000	99,000
February	550	180	99,000	1,00,000
March	580	220	1,27,600	1,25,000

P = Productivity per machine hour

= Number of units produced / Machine hours

For January $P = 99,000/88,000 = 1.125$

February $P = 100,000 / 99,000 = 1.010$

March $P = 125,000 / 127,600 = 0.980$

Interpretation: Though the total production in number of units is increasing, the productivity is declining.

Illustration 7.

Calculate the standard production per shift of 8 hours duration, with the following data: Observed time per unit = 5 minutes, Rating Factor -120%, Total allowances = 30% of normal time.

Answer:

Normal time per unit = Observed time / unit \times Rating factor = $5 \times (120/100) = 6$ minutes

Allowances = 30% of normal time = $(30 \times 6)/100 = 1.8$ minutes

Standard time/unit = Normal time/unit + Allowances = $6 + 1.8 = 7.8$ minutes / unit

Standard production in shift of 8 hours = $(8 \times 60)/7.8 = 61.54$ units.

Illustration 8.

Study in the Packaging Department of a Softdrinks Manufacturing unit revealed the following facts for a worker Basant Rao Patil.

Activity Element	Cycle No.				Performance Rating
	1	2	3	4	
(A) Get empty cartoon	0.15 min	0.25 min	—	0.17 min	90%
(B) Place 30 bottles in the cartoon	1.56 min	*	1.80 min	1.75 min	105%
(C) Close the cartoon & set aside	0.20 min	†	0.10 min	0.15 min	95%
(D) Smoking	—	0.50 min	—	—	—

* Bottles slipped out of hands and broke

† Empty cartoon not set aside and used for packaging in the next cycle.



Calculate the standard production by Basant Rao in a shift of 8 hours when the units standard rules allow 10% as Allowance Factor.

Answer:

$$\text{Average time for Activity Element A} = \frac{0.15+0.25+0.17}{3} = 0.19 \text{ min.}$$

$$\text{Average time for Activity Element B} = \frac{1.56+1.80+1.75}{3} = 1.703 \text{ min.}$$

$$\text{Average time for Activity Element C} = \frac{0.20+0.10+0.15}{3} = 0.15 \text{ min.}$$

Computation of Normal Time

Activity Element	Average time (Mins)	Performance Rating (%)	Normal Time (Mins)
(1)	(2)	(3)	(4) = (2) × (3) ÷ 100
A	0.19	90	0.171
B	1.703	105	1.788
C	0.15	95	0.142
Total	—	—	2.101

So Normal Time for the job of packaging = 2.101 Mins

$$\text{Standard Time} = \frac{\text{Normal Time}}{1 - (\text{Allowance Factor} / 100)} = \frac{2.101}{1 - \frac{10}{100}} = 2.334 \text{ Mins.}$$

$$\text{Standard Production in a shift of 8 hours} = \frac{8 \times 60}{2.334} = 205.66 \text{ cartoons.}$$

Illustration 9.

A department works on 8 hours shift, 288 days a year and has the usage data of a machine, as given below:

Product	Annual Demand (units)	Processing time (Standard time in hours)
A	325	5.0
B	450	4.0
C	550	6.0

Calculate (a) Processing time needed in hours to produce products A, B and C, (b) Annual production capacity of one machine in standard hours, and (c) Number of machines required

Answer:

(a) The processing time needed in hours to produce products A, B and C in the quantities demanded using the standard time data:

Product	Annual Demand (units)	Processing time (standard time in hours)	Processing time needed to produce demand quantity (hrs.)
A	325	5.0	325 × 5 = 1,625
B	450	4.0	450 × 4 = 1,800
C	550	6.0	550 × 6 = 3,300
			Total = 6,725 hrs.



- (b) Annual production capacity of one machine in standard hours = $8 \times 288 = 2,304$ hours per year.
- (c) Number of machines required = $\text{Work load per year} / \text{Production capacity per Machine} = 6,725 / 2,304 = 2.90$
machines = 3 machines.

Illustration 10.

Following results are recorded in a study of work sampling carried for 100 hours in a Machine Shop.

1. Total no. of observations recorded — 2500
2. No. of observations in which no working activity is noticed — 400
3. Ratio of Manual to Machine elements — 2:1
4. Average Rating Factor — 115%
5. No. of articles produced during the study period — 6000

As per the policy of the company, rest and personal allowances are taken as 12% of Normal Time. Calculate Standard Time to produce an article.

Given that the shop produces 42000 articles per month of 25 working days by 5 workers working for a shift of 8 hours per day. Consider absenteeism to be 7%.

Compute Efficiency of utilisation of Labour and Productive Efficiency of Labour.

Answer:

$$\text{Percentage of working time} = \frac{2500 - 400}{2500} \times 100 = 84\%$$

Actual working time in a study of 100 hours = 84 hours = $84 \times 60 = 5040$ mins.

Production — 6000 articles

$$\text{Time required to produce an article} = \frac{5040}{6000} = 0.84 \text{ mins}$$

$$\begin{aligned} \text{Of this Manual time} &= 0.84 \times \frac{2}{3} \quad (\because \text{Ratio of Manual to Machine activity elements} = 2:1) \\ &= 0.56 \text{ mins} \end{aligned}$$

$$\text{Machine time} = 0.84 \times \frac{1}{3} = 0.28 \text{ min.}$$

Normal Time of man = Time of man as per study \times Rating Factor / 100

$$= 0.56 \times \frac{115}{100} = 0.644 \text{ min.}$$

Normal Time of machine = 0.28 min.

Allowances for man = 12% of Normal time of Man = $0.12 \times 0.644 = 0.077$ min

Standard Time for Man to produce an article = Normal Time of Man + Allowances
= $0.644 + 0.077 = 0.721$ min.

Standard Time for machine = 0.28 min.

Standard Time to produce an article = $0.28 + 0.721 = 1.001$ mins.

Standard time required to produce 42000 articles = $42000 \times 1.001 = 42042$ mins. = 700.7 hours.

No. of days/month - 25, Daily working hours - 8, No. of workers - 5



Total available working hours/month = $5 \times 25 \times 8 = 1000$

Actual working hours/month = 1000×0.93 [Since Absentism = 7%]
= 930

Efficiency of utilisation of Labour = $\frac{\text{Standard time to produce 42000 articles}}{\text{Total available hours}} \times 100$
= $\frac{700.7}{1000} \times 100 = 70.07\%$

Productive efficiency of Labour = $\frac{\text{Standard time to produce 42000 articles}}{\text{Actual working hours}} \times 100$
= $\frac{700.7}{930} \times 100 = 75.34\%$



Study Note - 6

PROJECT MANAGEMENT



This Study Note includes

- 6.1 Project Planning
- 6.2 Gantt Charts
- 6.3 PERT and CPM

6.1 PROJECT PLANNING

Planning begins with well-defined objectives. The project team may be drawn from several organizational departments, e.g., engineering, production, marketing, and accounting. Project definition involves identifying the controllable and uncontrollable variables involved, and establishing project boundaries. Performance criteria should relate to the project objectives, which are often evaluated in terms of time, cost, and resource utilisation.

Project planning is part of project management, which relates to the use of schedules such as Gantt charts to plan and subsequently report progress within the project environment. **Project management** is the discipline of organizing and managing resources (e.g. people) in such a way that the project is completed within defined scope, quality, time and cost constraints. A project is a temporary and one-time endeavour undertaken to create a unique product or service, which brings about beneficial change or added value. This property of being a temporary and one-time undertaking contrasts with processes, or operations, which are permanent or semi-permanent ongoing functional work to create the same product or service over and over again. The management of these two systems is often very different and requires varying technical skills and philosophy, hence requiring the development of project managements.

The first challenge of project management is to make sure that a project is delivered within defined constraints. The second, more ambitious challenge is the optimized allocation and integration of inputs needed to meet predefined objectives. A project is a carefully defined set of activities that use resources (money, people, materials, energy, space, provisions, communication, etc.) to meet the predefined objectives.

Initially, the project scope is defined and the appropriate methods for completing the project are determined. Following this step, the durations for the various tasks necessary to complete the work are listed and grouped into a work breakdown structure. The logical dependencies between tasks are defined using an activity network diagram that enables identification of the critical path. Float or slack time in the schedule can be calculated using project management software. Then the necessary resources can be estimated and costs for each activity can be allocated to each resource, giving the total project cost. At this stage, the project plan may be optimized to achieve the appropriate balance between resource usage and project duration to comply with the project objectives. Once established and agreed, the plan becomes what is known as the baseline. Progress will be measured against the baseline throughout the life of the project. Analysing progress compared to the baseline is known as earned value management.

Gantt Chart: Gantt Chart is a principal tool used in scheduling and also in some methods of loading. This chart was originated by the American engineer Henry L. Gantt and consists of a simple rectangular grid, divided by series of parallel horizontal and vertical lines. The vertical lines always divide the horizontal scale units of time. The time units can be in years, months, weeks, days, hours, minutes or even seconds according to the work for which it is prepared. In this chart, the time which an activity takes in completing the task is represented by the horizontal line. The length of the line is drawn in proportion to the duration of time. Generally, the time in the chart should flow from left to right and activities be listed from top to bottom. The progress of the work may be shown by a bar or a line within the uprights of the activity symbol and its length should represent the amount of work completed.



Horizontal lines divide the chart into sections which can represent various work tasks (work schedule) or work centres (load schedule). When it shows only work tasks-products, orders, or operations to be completed, it is known as Work Schedule. When it shows the same task opposite the work centres at which they are produced-factories, departments, workshops, machine tools or men it is known as Load Chart.

The units scheduled or loaded on these charts are always the same because these work tasks are known as having a known standard time. The work tasks can be represented on the chart by numbers or symbols. The symbols used on the chart may vary from company to company.

Network Analysis: Routing is the first step in production planning. In small projects, routing is very simple. Sequence of operations is almost decided and the operations can be performed one after the other in a given sequence. But in large project, this is rather a difficult problem. There may be more than one route to complete a job. The function of production manager is to find out the path which takes the least time in completing the project.

In a big project, many activities are performed simultaneously. There are many activities which can be started only at the completion of other activities. In such cases, a thorough study is required to collect the complete details about the project and then to find out a new, better and quicker way to get the work done in a decent way. In such cases, the first step is to draw some suitable diagram showing various activities and their positions in the project. It should also explain the time to be taken in completing the route from one operation to the other. It also defines the way in which the delay in any activity can affect the entire project in terms of both money and time. Such a diagram is called network diagram. A network is a picture of a project, a map of requirements tracing the work from a departure points to the final completion objective. It can be a collection of all the minute details involved or only a gross outline of general functions.

Important characteristics in a Network Analysis: The following are some important points to remember in a network analysis:

- (i) The objective is to finish within the specified time otherwise there is a penalty.
- (ii) Various activities are to be completed in an order; however, a number of activities are performed simultaneously while there are many other activities, which can be started only when some other activities are completed.
- (iii) The cost of any activity is proportional to its time of completion.
- (iv) There can be hurdles in the process and the resources to be allocated may be limited. A network graph consists of a number of points or nodes, each of which is connected to one or more of the other nodes by routes or edges. It is a set of operations and activities describing the time orientation of a composite project.

Important Concept of Network drawing:

A Network can be considered as a means of graphically depicting all the operations involved in a Project. When a Network is constructed then it is essential to maintain the relationship between various Activities of the Project.

Some of the key concepts of Network drawing can start with defining some of the key terminology of Network. These are —

Activity — All projects may be viewed as a number of operations which when completed will cause the completion of the project. Each of these operations is termed as an **Activity** of the project which require expenditure of time and resources for accomplishment.

In a Network diagram, an Activity is depicted by a single arrow (→). This is not scaled and as such it's length has no bearing on the time the Activity takes for its completion. In other words the length of Activity arrow is drawn conveniently so that the clarification of relationship of activities is proper. It does not depict the importance of time. The head of the arrow shows the direction of flow of the Activity. An Activity can not begin until the preceding one/ones is/are not completed.

Predecessor Activity means the Activity that must be completed prior to the start of an Activity.

Successor Activity can not be started until are or more of the other activities are completed but immediately succeed them.

Concurrent Activities means the Activities which can occur simultaneously.

Event — An **Event** represents a specific accomplishment in the project and takes place at a particular instant of time and does not, therefore consume time or resources. It can be considered as a time oriented reference point that signifies the end of an activity and start of another. Events are represented by circles (○) in a Network diagram, Events are also known as Nodes.

All Activity arrows must begin and end with Event nodes as shown below :-

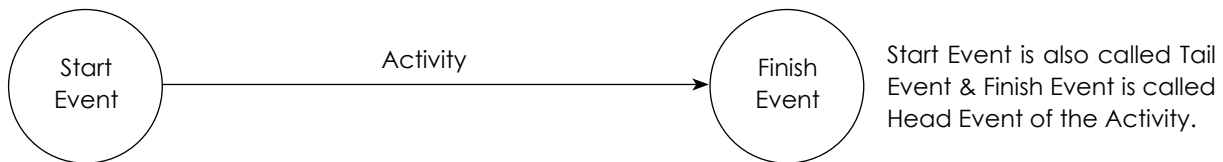

Merge Event is that event where more than one Activity ends. In the diagram below 3 and 4 are the Merge Events.

Burst Event is that Event from where more than one Activity starts. In the diagram below, 2 and 1 are the Burst Events.

Merge and Burst Events are those Events where more than one Activity ends and from where more than one Activity starts. In other words these are the combination of both Merge and Burst Events.

Dummy Activity — Activities occurring simultaneously, is a very common feature in a project. Also it can so happen that two Activities are having same Start and End Events. To resolve such situations, Dummy Activities are introduced. Hence as a rule there is only one Activity between two Events. With the use of Dummy Activity, other activities can be identified by unique end events. Dummy Activities consume no time or resource. In Network diagrams these are represented by dashed arrows (- - - →) and is inserted in the Network to clarify activity pattern in the following situations

- to make activities with common start and end Events distinguishable
- to identify and maintain the proper precedence relationship between activities that are not connected by events.

For the situation where A & B are concurrent activities, C is dependent on B and D is dependent on both A & B we have no other option but to introduce a Dummy Activity (Shown in the diagram) to clearly represent the precedence relationship of the Activities.

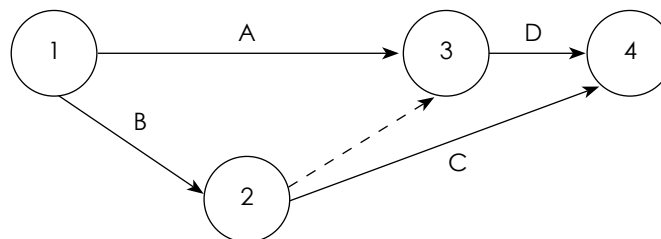

Procedure for drawing a network diagram: The procedure for drawing a network diagram may be explained below.

There are three basic questions and the network depends on them.

These questions are:

- Which operation must be completed before each given operation can be started?
- Which activities can be carried out in parallel?
- Which operation immediately succeeds other given activities?

The common practice is simply to work backward through the list of operations, generating the immediate predecessors for each operation.



Slack and float:

Slack - Slack signifies the freedom for rescheduling or to start the job. It can be calculated by the difference between EFT and LFT for any job. A job for which the slack time is zero is known as critical job. The critical path can be located by all those activities or events for which slack time is either zero or float time is the least. The abbreviations EFT and LFT given in the above line have the following explanation.

EFT (Earliest Finish Time) - this is the sum of the earliest start time plus the time of duration for any event.

LFT (Latest Finish Time) - It is calculated from the LFT of the head event. For its calculation total project time is required. The total project time is the shortest possible time required in completing the project.

Floats - Floats in the network analysis represent the difference between the maximum time available to finish the activity and the time required to complete it. There are so many activities where the maximum time available to finish the activity is more than the total time required to complete it. This difference is known as floats.

Floats may be total, free, and independent:

Total Float: Total float is the maximum amount by which duration time of an activity can be increased without increasing the total duration time of the project. Total float can be calculated as follows:

- (i) First, the difference between Earliest Start Time (EST) of tail event and Latest Finish Time (LFT) of head event for the activity shall be calculated.
- (ii) Then, subtract the duration time of the activity from the value obtained in (i) above to get the required float for the activity.

The total float can be helpful in drawing the following conclusions:

- (a) If total float value is negative, it denotes that the resources for completing the activity are not adequate and the activity, therefore, cannot finish in time. So, extra resources or say critical path needs crashing in order to reduce the negative float.
- (b) If the total float value is zero, it means the resources are just sufficient to complete the activity without any delay.
- (c) If the total float value is positive, it points out that total resources are in excess of the amount required or the resources should be reallocated to avoid the delay otherwise the activity will be delayed by so much time.

Free Float: It is that fraction from total float of an activity which can be used for rescheduling the activity without affecting the succeeding activity. If both tail and head events are given their earliest times, i.e., EST and EFT the Free Float can be calculated by deducting head slack from total float, i.e.,

$$\text{Free Float} = \text{Total float} - \text{Slack time of the head event.}$$

Independent Float: It is the time by which the start of an activity can be rescheduled without affecting the earliest start time of any immediately following activities assuming that the preceding activity has finished at its latest finish time. It may be calculated as

$$\text{Independent Float} = \text{Free Float} - \text{Tail Slack}$$

or, Independent Float = Free Float - Slack Time of tail event. The basic difference between slack and float time is that a slack is used with reference to events whereas float is used with reference to activity.

Use of Float Information in Decision Making: The float information can be used in decision-making in the following ways:

- (i) Total float can affect both the previous and the subsequent activities.
- (ii) Total float can be used without affecting the subsequent activities.
- (iii) Independent float can be used in allocating the resources elsewhere and increasing the time of some non-critical activities.
- (iv) Negative float signifies reduction in target time to finish the work in time.



Critical Path Method (CPM): The critical path analysis is an important tool in production planning and scheduling. Gantt charts are also one of the tools of scheduling but they have one disadvantage for which they are found to be unsuitable. The problem with Gantt Chart is that the sequence of operations of a project or the earliest possible date for the completion of the project as a whole cannot be ascertained. This problem is overcome by this method of Critical Path Analysis.

CPM is used for scheduling special projects where the relationship between the different parts of projects is more complicated than that of a simple chain of task to be completed one after the other. This method (CPM) can be used at one extreme for the very simple job and at other extreme for the most complicated tasks.

A CPM is a route between two or more operations which minimises (or maximises) some measures of performance. This can also be defined as the sequence of activities which will require greatest normal time to accomplish. It means that the sequence of activities which require longest duration are singled out. It is called a critical path because any delay in performing the activities on this path may cause delay in the whole project. So, such critical activities should be taken up first.

One of the purposes of critical path analysis is to find the sequence of activities with the largest sum of duration times, and thus find the minimum time necessary to complete the project. The path of the Network with the critical series of activities is known as the '**Critical Path**'.

Under CPM, the project is analysed into different operations or activities and their relationship are determined and shown on the network diagram. So, first of all a network diagram is drawn. After this the required time or some other measure of performance is posted above and to the left of each operation circle. These times are then combined to develop a schedule which minimises or maximises the measure of performance for each operation. Thus CPM marks critical activities in a project and concentrates on them.

Thus CPM technique is a very useful analysis in production planning of a very large project.

PERT (Programme Evaluation and Review Technique):

There are so many modern techniques developed recently for the planning and control of large projects in various industries especially in defence, chemical and construction industries. Perhaps, the PERT is the best known of such techniques.

PERT is a time-event network analysis technique designed to watch how the parts of a programme fit together during the passage of time and events. This technique was developed by the special project office of the U.S. Navy in 1958. It involves the application of network theory to scheduling problems. In PERT we assume that the expected time of any operation can never be determined exactly.

Major Features of PERT or Procedure or Requirement for PERT:

The following are the main features of PERT:

- (i) All individual tasks should be shown in a network. Events are shown by circles. Each circle represents an event—a subsidiary plan whose completion can be measured at a given time.
- (ii) Each arrow represents an activity—the time-consuming elements of a programme, the effort that must be made between events.
- (iii) Activity time is the elapsed time required to accomplish an event. In the original PERT, three-time values are used as follows:
 - t_1 (Optimistic time): It is the best estimate of time if everything goes exceptionally well.
 - t_2 (Most likely time): It is an estimated time what the project engineer believes necessary to do the job or it is the time which most often is required if the activity is repeated a number of times.
 - t_3 (Pessimistic time): It is also an estimate of time of an activity under adverse conditions. It is the longest time and rather is more difficult to ascertain.



The experiences have shown that the best estimator of time out of several estimates made by the project engineer is:

$$t = \frac{t_1 + 4t_2 + t_3}{6} \text{ and the variance of } t \text{ is given by: } V(t) = \left(\frac{t_3 - t_1}{6}\right)^2$$

(iv) The next step is to compute the critical path and the slack time.

A critical path or critical sequence of activities is one which takes the longest time to accomplish the work and the least slack time.

Difference in PERT and CPM - Although these techniques (PERT and CPM) use the same principles and are based on network analysis yet they are different in the following respects from each other:

- (i) PERT is appropriate where time estimates are uncertain in the duration of activities as measured by optimistic time, most likely time, and pessimistic time, whereas CPM (Critical Path Method) is good when time estimates are found with certainty. CPM assumes that the duration of every activity is constant and therefore does not deal with uncertainty in time.
- (ii) PERT is concerned with events which are the beginning or ending points of operation while CPM is concerned with activities
- (iii) PERT is suitable for non-repetitive projects while CPM is designed for repetitive projects.
- (iv) PERT can be analysed statistically whereas CPM not.
- (v) PERT is not concerned with the relationship between time and cost, whereas CPM establishes a relationship between time and cost and cost is proportionate to time.

6.2 GANTT CHARTS

Gantt chart is a graphical representation of a series of activities drawn to a time scale. Horizontal axis (X-axis) represents time and vertical axis (Y-axis) shows the activities to be performed. The Gantt chart shows activities to specific jobs at individual/work centers by horizontal bars. Also known as a 'bar chart' because of its graphic presentation of the information, the position and the length of the horizontal bar indicate the start and completion date of the activity.

Strengths of Gantt Charts

Gantt charts are preferred for various reasons, which are as follows:

- Very simple to understand by everyone e.g. foreman, engineers, managers, and top management.
- Provide useful information in a format that is simple to develop and interpret.
- It is a good tool for planning as well as monitoring the progress of the work. It helps schedulers to evaluate the progress of a project at various levels.
- Helps in loading the work center in relation to the available capacity.
- It provides the user with a quick, visual indication of the actual status of each order and its anticipated or planned status.
- The scheduler could easily incorporate changes in timing, machine loads, and current status.
- Some common changes make Gantt charts fairly flexible to apply. It indicates the need for reassessing the resources incase the load at one work station becomes too much. Workforce could be temporarily adjusted to meet the high demand of the heavily loaded workstation by shifting the manpower from a relatively less loaded work center. Even multi-purpose equipments are shifted from less loaded work centers to heavily loaded work centers.
- Gantt charts suit the requirements of a wide range of media from ruled paper to mechanical devices and computer systems.



Limitations

- It does not convey the variability of the task duration, equipment performance (including breakdowns), and human potential, any one of which could influence the accuracy of loading the work centers.
- It does not clearly indicate the details regarding progress of activities.
- It does not give a clear indication of the interrelationship between separate activities.
- The chart is static and has to be updated periodically to account for new job arrivals and revised time estimates for existing jobs.

Illustration 1.

A project consists of seven activities. Activities P, Q, R run simultaneously. The relationships among the various activities is as follows:

Activity	Immediate Successor
P	S
Q	T
R	U

Activity "V is the last operation of the project and it is also immediate successor to S, T and U. Draw the network of the project.

Solution:

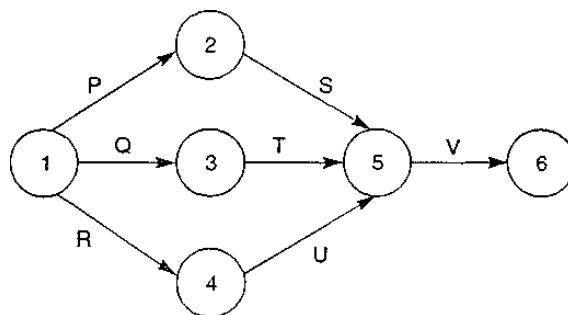

Illustration 2.

Project with the following data is to be implemented. Draw the network and find the critical path.

Activity	Predecessor	Duration (days)	Cost (₹ Day)
A	-	2	50
B	-	4	50
C	A	1	40
D	B	2	100
E	A,B	3	100
F	E	2	60

1. What is the minimum duration of the project?
2. Draw a Gantt chart for early start schedule.
3. Determine the peak requirement of money and the day on which it occurs in the above schedule.



Solution:

(1)

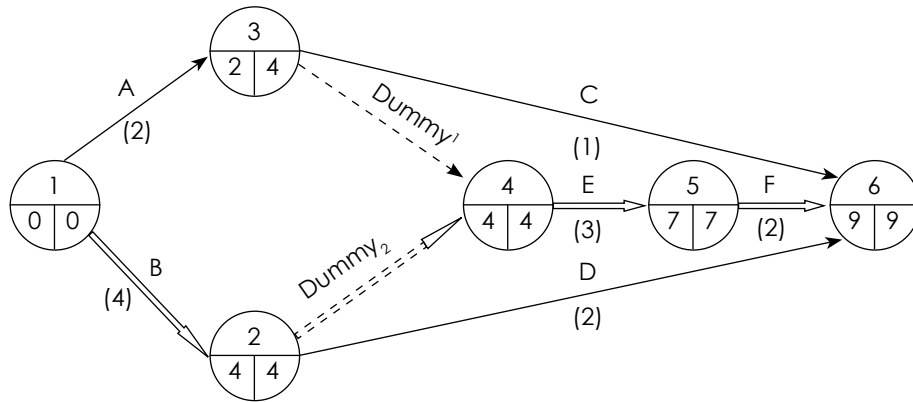

Critical Path B – Dummy₂ – E – F
 Minimum duration of the project = 9 days

Table: Activity Relationship

Activity	t	ES (EF- t)	EF	LS (LF- t)	LF	Event Slack (LS-ES) (LF-EF)	On Critical Path
A	2	0	2	2	4	2	No
B	4	0	4	0	4	0	Yes
C	1	4	5	8	9	4	No
D	2	4	6	7	9	3	No
E	3	4	7	4	7	0	Yes
F	2	7	9	7	9	0	Yes

(2) **Gantt Chart for Early Start Schedule**

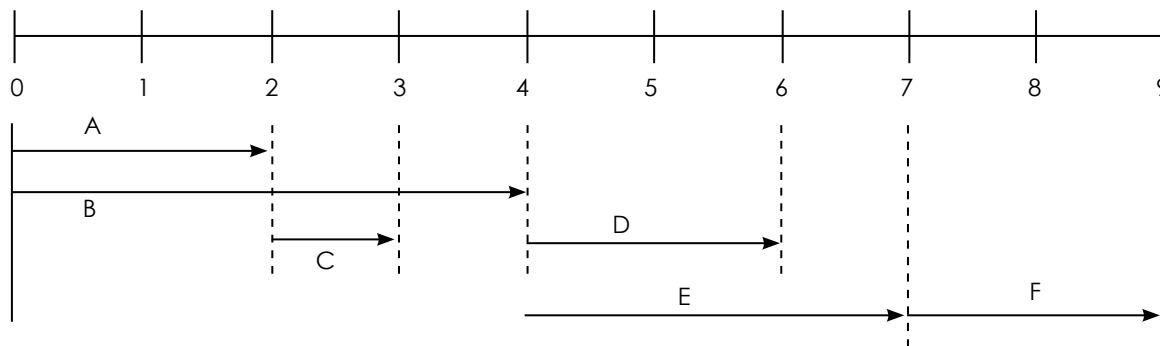

(3) Peak requirement of money will occur during simultaneous occurrence of Activities.

From the Network diagram above, it can be said that the following Activities need to occur simultaneously.

- (i) A & B — Either during the days 1 & 2 or during the days 3 & 4 of Project Duration, which will require (₹50 for A + ₹ 50 for B) per day i.e. ₹ 100 per day
- (ii) B & C — Either on day 3 or on day 4 of the project and it will require (₹ 50 for B + ₹ 40 for C) per day i.e. ₹ 90 per day



- (iii) C, D & E — During day no. 5 or day no. 6 and cost is ₹ (40 + 100 + 100) = ₹ 240 per day
- (iv) C, D & F — During day no. 8 or day no. 9 and cost is ₹ (40 + 100 + 60) = ₹ 200 per day
- (v) D & E — During day nos. 5 & 6 or 6 & 7. Cost is ₹ (100 + 100) = ₹ 200 per day
- (vi) D & F — During day nos. 8 & 9. Cost = ₹ (100 + 60) = ₹ 160 per day
- (vii) C & E — Either on day no. 5 or 6 or 7. Cost to be incurred = ₹ (40 + 100) = ₹ 140 per day

From above we can say that C can occur by using either of the options (ii), (iii), (iv) & (vii). As cost fo option (ii) is least one should decide fo it at a cost of ₹ 90 per day.

Similarly D can occur by either of the option (iii), (iv), (v) & (vi) above. As (vi) is the least cost option of all these, one should go for it at a cost of ₹ 160 per day.

Hence the Project Activities should follow the sequence given below:-

- (a) A & B to start at their Earliest Time (i.e 0) and occur simultaneously till day 2 @ ₹ 100 per day
- (b) C can start either at its Earliest Time (i.e. 2) or on day 3 and occur simultaneously with B either on day 3 or 4 @ ₹90 per day
- (c) E being Critical Activities must have to start at it's earliest time (i.e. 4) and occur @ ₹ 100 per day
- (d) F being Critical Activity has to start on Earliest Time (i.e. 7) and will occur concurrently with D is the during days 8 & 9 @ ₹ 160 per day.

Hence peak requirement of money is ₹ 160 per day and it will occur at days 8 and 9.

Illustration 3.

A project has the following time schedule

Activity	1-2	1-3	1-4	2-5	3-6	3-7	4-6	5-8	6-9	7-8	8-9
Time (months)	2	2	1	4	8	5	3	1	5	4	3

Construct a PERT network and compute

- Critical path and its duration
- Total float for each activity

Also, find the minimum number of cranes the project must have for its activities 2-5, 3-7, 5-8 and 8-9 without delaying the project given that one crane is sufficient to carry out the work involved in each activity if taken care of individually.

Solution:

Steps:

1. Moving forward, find EF times (choosing the Maximum at activity intersection)
2. Maximum EF = LF = Critical Path Time.
3. Return path find LF (Choosing the Minimum at activity intersection)
4. Note LF, EF from network (except activity intersections)

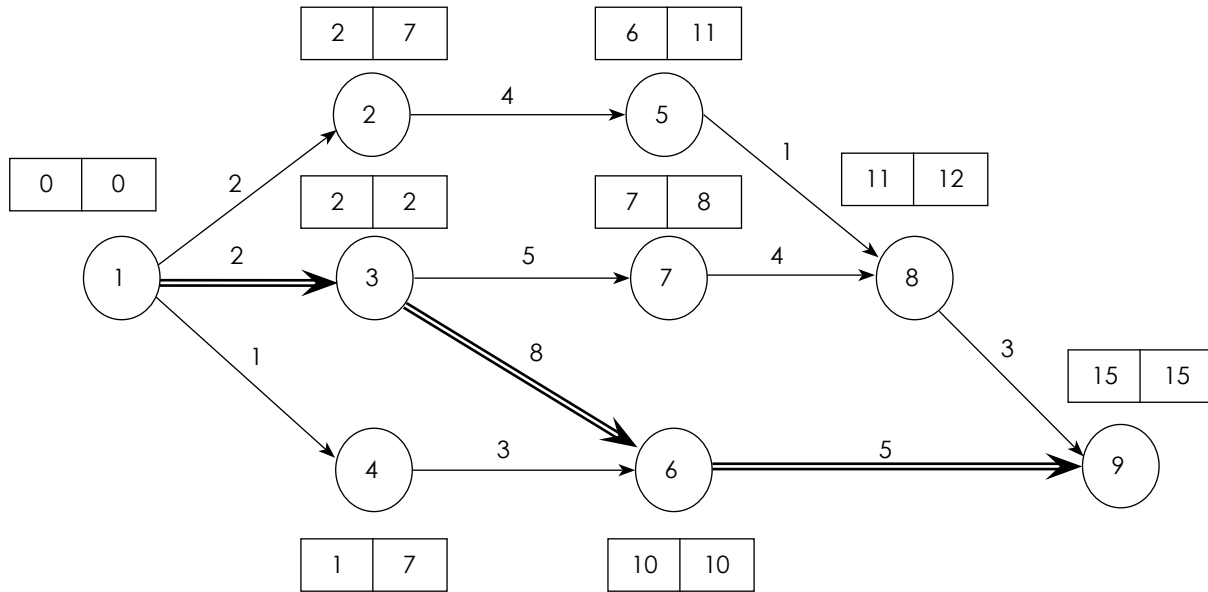

Table: Activity Relationship

Activity	Duration Months (t_{ij})	Earliest Start (ES_{ij})	Earliest Finish ($EF_{ij} = ES_{ij} + t_{ij}$)	Latest Start ($LS_{ij} = LF_{ij} - t_{ij}$)	Latest Finish (LF_{ij})	Total Float ($TF_{ij} = LS_{ij} + ES_{ij} = LE_{ij} - EF_{ij}$)
1-2	2	0	2	5	7	5
1-3	2	0	2	0	2	0
1-4	1	0	1	6	7	6
2-5	4	2	6	7	11	5
3-6	8	2	10	2	10	0
3-7	5	2	7	3	8	1
4-6	3	1	4	7	10	6
5-8	1	6	7	11	12	5
6-9	5	10	15	10	15	0
7-8	4	7	11	8	12	1
8-9	3	11	14	12	15	1

Critical path is 1-3-6-9 with duration 15 months



Minimum number of cranes

- Finish 3 — 7 at its earliest finish time 7 with one crane
- Finish 2 — 5 at its latest finish time $7 + 4 = 11$ with the same crane by starting the activity at its latest start time 7
- Finish 5 — 8 at its latest finish time $11 + 1 = 12$ with the same crane by starting the activity at its latest start time 11
- Finish 8 — 9 at its latest finish time $12 + 3 = 15$ with the same crane by starting the activity at its latest start time 12

Therefore, one crane will be sufficient if start time of the following activities are:

- Activities 2-5 — 7
- Activities 5-8 — 11
- Activities 8-9 — 12

Illustration 4.

A project consists of five activities. Activities P and Q run simultaneously. The relationship among the various activities is as follows:

Activity	Immediate Successor
P	R
Q	S

Activity T is the last operation of the project and it is also immediate successor to R and S. Draw the network of the Project.

Answer:

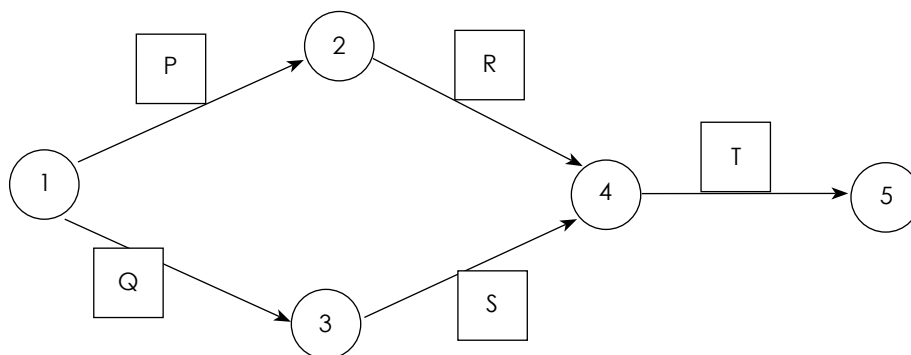



6.3 PERT AND CPM

Network Analysis

Network analysis is the general name given to certain specific techniques which can be used for planning, management and control of project. It often acts as a network management tool for breaking down projects into components or individual activities and recording the result on a flow chart or network diagram. These results generally reveal information that is used to determine duration, resource limitations and cost estimates associated with the project.

It offers insight into what is occurring at each critical point of the network. Project management and efficient resource allocation are two critical aspects of the production and operations managers' responsibilities. Since a project is non-repetitive and temporal in nature, the mode of management differs from the usual job shop or other related types of scheduling.

Network analysis enables us to take a systematic quantitative structural approach to the problem of managing a project through to successful completion. Also, since it has a graphical representation, it can be easily understood and used by those with a less technical background.

Network is a graphical representation of all the Activities and Events arranged in a logical and sequential order. Network analysis plays an important role in project management. A project is a combination of interrelated activities all of which must be executed in a certain order for its completion. Activity is the actual performance of the job. This consumes resources (Time, human resources, money, and material. An event refers to start or completion of a job. This does not consume any resources.

Applications:

- Construction of a Residential complex,
- Commercial complex,
- Petro-chemical complex
- Ship building, Aircraft Manufacturing
- Satellite mission development
- Installation of a pipe line project etc...

The procedure of drawing a network is:

1. **Specify the Individual Activities:** From the work breakdown structure, a listing can be made of all the activities in the project. This listing can be used as the basis for adding sequence and duration information in later steps.
2. **Determine the Sequence of the Activities:** Some activities are dependent on the completion of others. A listing of the immediate predecessors of each activity is useful for constructing the CPM network diagram.
3. **Draw the Network Diagram:** Once the activities and their sequencing have been defined, the CPM diagram can be drawn. CPM originally was developed as an activity on node (AON) network, but some project planners prefer to specify the activities on the arcs.
4. **Estimate Activity Completion Time:** The time required to complete each activity can be estimated using past experience or the estimates of knowledgeable persons. CPM is a deterministic model that does not take into account variation in the completion time, so only one number is used for an activity's time estimate.
5. **Identify the Critical Path:** The critical path is the longest-duration path through the network. The significance of the critical path is that the activities that lie on it cannot be delayed without delaying the project. Because of its impact on the entire project, critical path analysis is an important aspect of project planning.



The critical path can be identified by determining the four parameters for each activity. The four parameters are Earliest Start, Earliest Finish, Latest Finish and Latest Start.

Rules for drawing the network diagrams.

In a network diagram, arrows represent the activities and circles represent the events.

- The tail of an arrow represents the start of an activity and the head represent the completion of the activity.
- The event numbered 1 denotes the start of the project and is called initial event.
- Event carrying the highest number in the network denotes the completion of the project and is called terminal event.
- Each defined activity is represented by one and only arrow in the network.
- Determine which operation must be completed immediately before other can start.
- Determine which other operation must follow the other given operation.
- The network should be developed on the basis of logical, analytical and technical dependencies between various activities of the project.

The basic network construction – Terminology used.

Network representation: There are two types of systems –

AOA system (Activity on Arrow system)	AON system (Activity on Node system)
In this activities are represented by an arrows.	In this method activities are represented in the circles.

A project consists of tasks with definite starting and ultimate ending points and hence a project manager is saddled with the responsibilities of getting job done on schedule within allowable cost and time constraint specified by the management. Typically all projects can be broken into:

Separate activities – where each activity has an associated completion time (time from the start of the activity to its finish).

Precedence relationships – which govern order in which we may perform the activities.

The main problem is to bring all these activities together in a coherent fashion to complete the project at a required time.

Apart from the traditional method of adding activity durations, these exist two different techniques for network analysis namely the PERT – Program Evaluation and Review Technique and CPM – Critical Path Management.

PERT has the ability to cope with uncertainty in activity completion times while CPM emphasized on the trade-off between cost of the project and its overall completion time.

The CPM has the advantage of decreasing completion times by probably spending more money.

Differences between PERT & CPM

PERT	CPM
1. It is a technique for planning scheduling & controlling of projects whose activities are subject to uncertainty in the performance time. Hence it is a probabilistic model.	1. It is a technique for planning scheduling & controlling of projects whose activities not subjected to any uncertainty and the performance times are fixed. Hence it is a deterministic model.
2. It is an Event oriented system	2. It is an Activity oriented system
3. Basically does not differentiate critical and non-critical activities.	3. Differentiates clearly the critical activities from the other activities.



4. Used in projects where resources (men, materials, money) are always available when required.	4. Used in projects where overall costs is of primarily important. Therefore better utilized resources.
5. Suitable for Research and Development projects where times cannot be predicted.	5. Suitable for civil constructions.

Critical Path Analysis and PERT are powerful tools that help you to schedule and manage complex projects. They were developed in the 1950s to control large defense projects, and have been used routinely since then.

As with Gantt Charts, Critical Path Analysis (CPA) or the Critical Path Method (CPM) helps you to plan all tasks that must be completed as part of a project. They act as the basis both for preparation of a schedule, and of resource planning. During management of a project, they allow you to monitor achievement of project goals. They help you to see where remedial action needs to be taken to get a project back on course.

Within a project it is likely that you will display your final project plan as a Gantt Chart (using Microsoft Project or other software for projects of medium complexity or an excel spreadsheet for projects of low complexity). The benefit of using CPA within the planning process is to help you develop and test your plan to ensure that it is robust. Critical Path Analysis formally identifies tasks which must be completed on time for the whole project to be completed on time. It also identifies which tasks can be delayed if resource needs to be reallocated to catch up on missed or overrunning tasks. The disadvantage of CPA, if you use it as the technique by which your project plans are communicated and managed against, is that the relation of tasks to time is not as immediately obvious as with Gantt Charts. This can make them more difficult to understand.

A further benefit of Critical Path Analysis is that it helps you to identify the minimum length of time needed to complete a project. Where you need to run an accelerated project, it helps you to identify which project steps you should accelerate to complete the project within the available time.

Critical Path Analysis (CPA) is a project management tool that:

- Sets out all the individual activities that make up a larger project.
- Shows the order in which activities have to be undertaken.
- Shows which activities can only taken place once other activities have been completed.
- Shows which activities can be undertaken simultaneously, thereby reducing the overall time taken to complete the whole project.
- Shows when certain resources will be needed – for example, a crane to be hired for a building site.

In order to construct a CPA, it is necessary to estimate the elapsed time for each activity – that is the time taken from commencement to completion.

Then the CPA is drawn up based on dependencies such as:

- The availability of labour and other resources
- Lead times for delivery of materials and other services
- Seasonal factors – such as dry weather required in a building project

Once the CPA is drawn up, it is possible to see the CRITICAL PATH itself – this is a route through the CPA, which has no spare time (called 'FLOAT' or 'slack') in any of the activities. In other words, if there is any delay to any of the activities on the critical path, the whole project will be delayed unless the firm makes other changes to bring the project back on track.

The total time along this critical path is also the minimum time in which the whole project can be completed.

Some branches on the CPA may have FLOAT, which means that there is some spare time available for these activities.



What can a business do if a project is delayed?

- Firstly, the CPA is helpful because it shows the likely impact on the whole project if no action were taken.
- Secondly, if there is float elsewhere, it might be possible to switch staff from another activity to help catch up on the delayed activity.
- As a rule, most projects can be brought back on track by using extra labour – either by hiring additional people or overtime. Note, there will be usually be an extra cost. Alternative suppliers can usually be found – but again, it might cost more to get urgent help.
- Nodes are numbered to identify each one and show the Earliest Start Time (EST) of the activities that immediately follow the node, and the Latest Finish Time (LFT) of the immediately preceding activities
- The CPA must begin and end on one 'node' – see below
- There must be no crossing activities in the CPA
- East activity is labelled with its name eg 'print brochure', or it may be given a label, such as 'D', below.
- The activities on the critical path are usually marked with a '///'

In the example below

- The Node is number 3
- The EST for the following activities is 14 days
- The LFT for the preceding activities is 16 days
- There is 2 days' float in this case (difference between EST and LFT)
- The activity that follows the node is labelled 'D' and will take 6 days

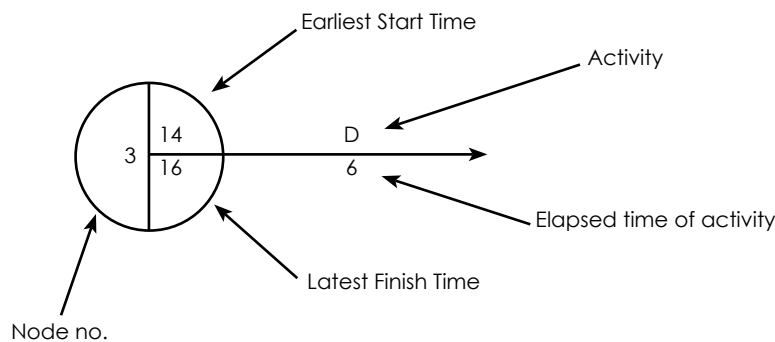

A simple example – baking a loaf of bread

Here is a simple example, in which some activities depend on others having been undertaken in order, whereas others can be done independently.

Activity	Preceded by	Elapsed time (minutes)
A - Weigh ingredients	-	1
B - Mix ingredients	A	3
C - Dough rising time	B	60
D - Prepare tins	-	1
E - Pre-heat oven	-	10
F - Knock back dough and place in tins	C&D	2

G - 2 nd dough rising time	F	15
H - Cooking time	E & G	40

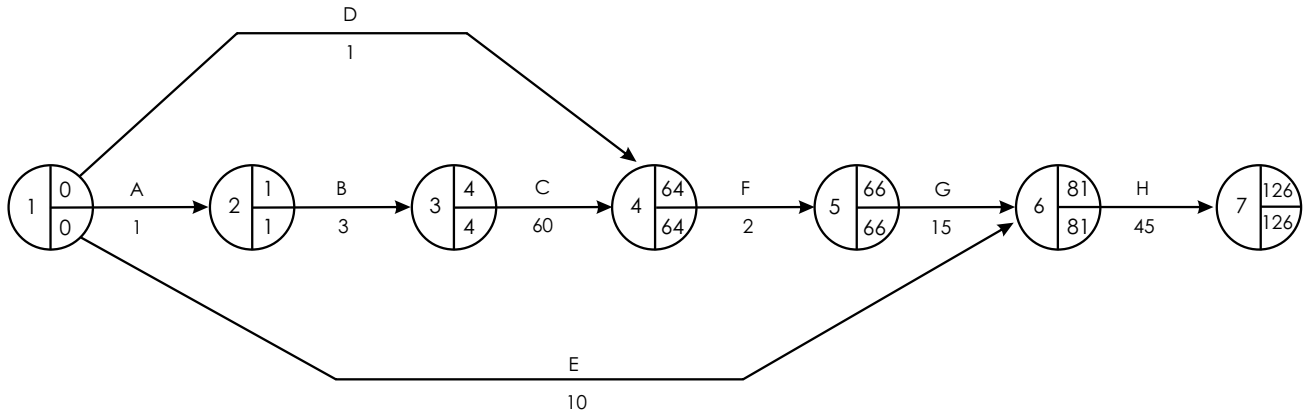

In this example, there is a clear sequence of events that have to happen in the right order. If any of the events on the critical path is delayed, then the bread will not be ready as soon. However, tasks D (prepare tins) and E (heat the oven) can be started at any time as long as they are done by the latest finish time in the following node.

So, we can see that the oven could be switched on as early as time 0, but we can work out that it could be switched on at any time before 71 – any later than this and it won't be hot enough when the dough is ready for cooking. There is some 'float' available for tasks D and E as neither is on the critical path.

This is a fairly simple example, and we can see the LST and LFT are the same in each node. In a more complex CPA, this will not necessarily be the case, and if so, will indicate that there is some 'float' in at least one activity leading to the node. However, nodes on the critical path will always have the same EST and LFT.

CPA is a planning and project management tool. Whilst it can help ensure a project is completed as quickly as possible, and resources used as efficiently as possible, it does depend on the accuracy of the information used.

Just drawing up a CPA will not in itself ensure a project runs to plan; most projects encounter some delay or something unexpected, so managers need to use tool such as CPA to monitor the project and take swift action to rectify any problems.

Drawing a Critical Path Analysis Chart

Use the following steps to draw a CPA Chart:

Step 1. List all activities in the plan

For each activity, show the earliest start date, estimated length of time it will take, and whether it is parallel or sequential. If tasks are sequential, show which stage they depend on.

Figure 1. Task List: Planning a custom-written computer project

Task	Earliest start	Length	Type	Dependent on...
A. High level analysis	Week 0	1 week	Sequential	
B. Selection of hardware platform	Week 1	1 day	Sequential	A
C. Installation and commissioning of hardware	Week 1.2	2 weeks	Parallel	B
D. Detailed analysis of core modules	Week 1	2 weeks	Sequential	A



E. Detailed analysis of supporting modules	Week 3	2 weeks	Sequential	D
F. Programming of core modules	Week 3	2 weeks	Sequential	D
G. Programming of supporting modules	Week 5	3 weeks	Sequential	E
H. Quality assurance of core modules	Week 5	1 week	Sequential	F
I. Quality assurance of supporting modules	Week 8	1 week	Sequential	G
J. Core module training	Week 6	1 day	Parallel	C,H
K. Development and QA of accounting reporting	Week 5	1 week	Parallel	E
L. Development and QA of management reporting	Week 5	1 week	Parallel	E
M. Development of Management Information System	Week 6	1 week	Sequential	L
N. Detailed training	Week 9	1 week	Sequential	I, J, K, M

Step 2. Plot the activities as a circle and arrow diagram

Critical Path Analyses are presented using circle and arrow diagrams.

In these, circles show events within the project, such as the start and finish of tasks. The number shown in the left hand half of the circle allows you to identify each one easily. Circles are sometimes known as nodes.

An arrow running between two event circles shows the activity needed to complete that task. A description of the task is written underneath the arrow. The length of the task is shown above it. By convention, all arrows run left to right. Arrows are also sometimes called arcs.

An example of a very simple diagram is shown below:

Figure 2: Simple Circle and Arrow Diagram

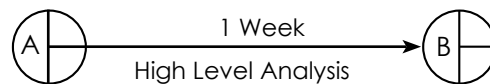

This shows the start event (circle 1), and the completion of the 'High Level Analysis' task (circle 2). The arrow between them shows the activity of carrying out the High Level Analysis. This activity should take 1 week.

Where one activity cannot start until another has been completed, we start the arrow for the dependent activity at the completion event circle of the previous activity. An example of this is shown below:

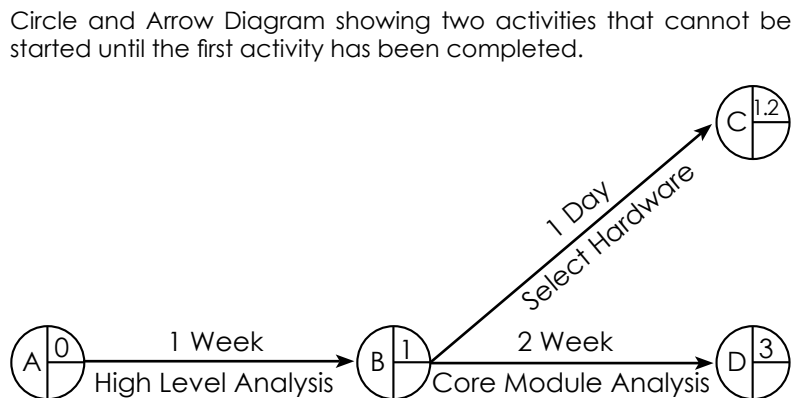

Here the activities of 'Select Hardware' and 'Core Module Analysis' cannot be started until 'High Level Analysis' has been completed. This diagram also brings out a number of other important points:

- Within Critical Path Analysis, we refer to activities by the numbers in the circles at each end. For example, the task 'Core Module Analysis' would be called activity 2 to 3. 'Select Hardware' would be activity 2 to 9.
- Activities are not drawn to scale. In the diagram above, activities are 1 week long, 2 weeks long, and 1 day long. Arrows in this case are all the same length.
- In the example above, you can see a second number in the top, right hand quadrant of each circle. This shows the **earliest start time** for the following activity. It is conventional to start at 0. Here units are whole weeks.

A different case is shown below:

Circle and Arrow Diagram showing an activity (6 to 7) that cannot start until other activities (11 to 6, 5 to 6, 4 to 6, and 8 to 6) have been completed.

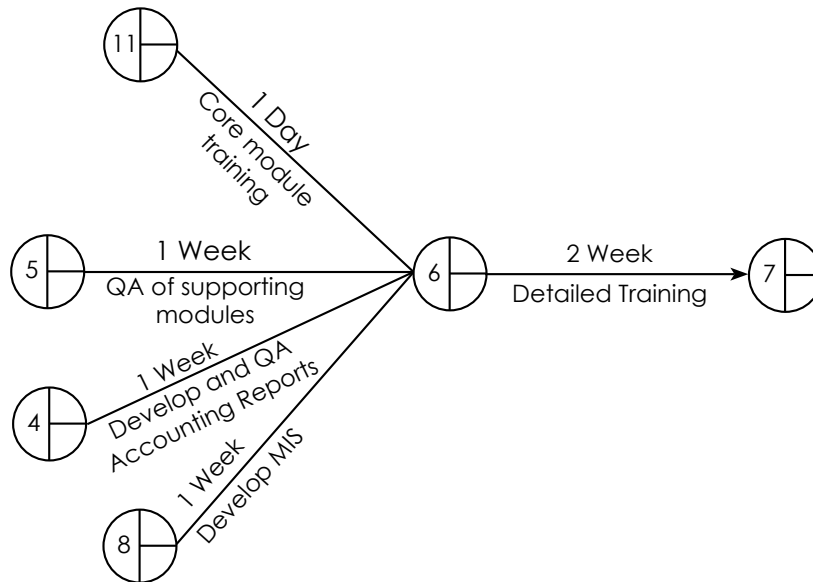

Here activity 6 to 7 cannot start until the other four activities (11 to 6, 5 to 6, 4 to 6, and 8 to 6) have been completed.

Click the link below for the full circle and arrow diagram for the computer project we are using as an example.

Critical Path Analysis for Example Computer Project

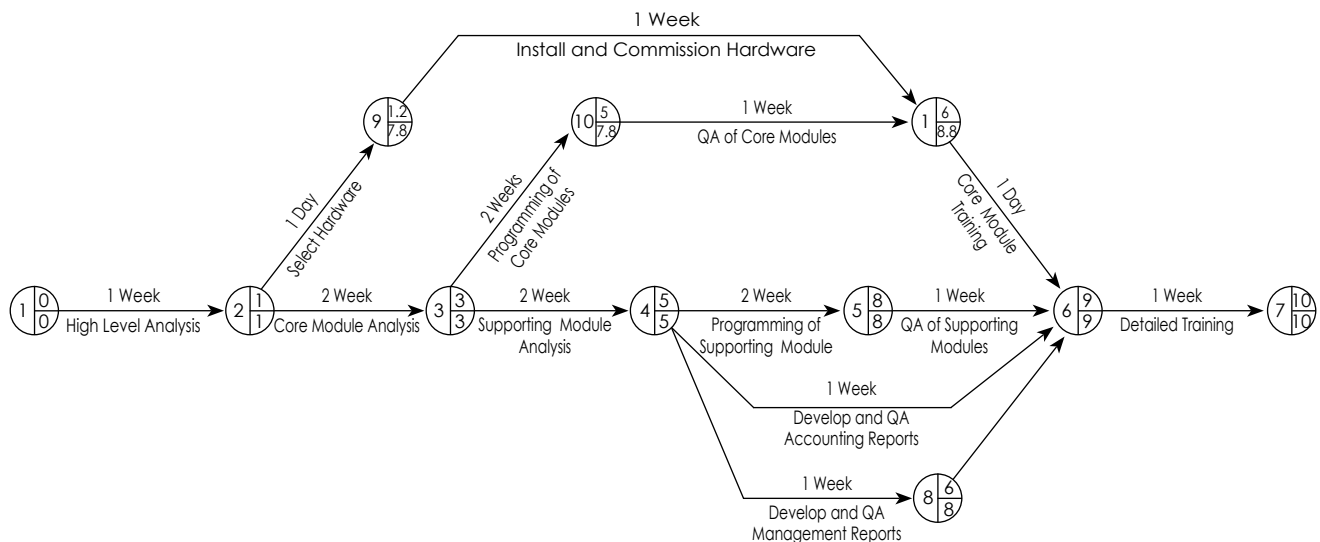



This shows all the activities that will take place as part of the project. Notice that each event circle also has a figure in the bottom, right hand quadrant. This shows the latest finish time that's permissible for the preceding activity if the project is to be completed in the minimum time possible. You can calculate this by starting at the last event and working backwards. The latest finish time of the preceding event and the earliest start time of the following event will be the same for circles on the critical path.

You can see that event M can start any time between weeks 6 and 8. The timing of this event is not critical. Events 1 to 2, 2 to 3, 3 to 4, 4 to 5, 5 to 6 and 6 to 7 must be started and completed on time if the project is to be completed in 10 weeks. This is the 'critical path' – these activities must be very closely managed to ensure that activities are completed on time. If jobs on the critical path slip, immediate action should be taken to get the project back on schedule. Otherwise completion of the whole project will slip.

'Crash Action'

You may find that you need to complete a project earlier than your Critical Path Analysis says is possible. In this case you need to re-plan your project.

You have a number of options and would need to assess the impact of each on the project's cost, quality and time required to complete it. For example, you could increase resource available for each project activity to bring down time spent on each but the impact of some of this would be insignificant and a more efficient way of doing this would be to look only at activities on the critical path.

As an example, it may be necessary to complete the computer project in Figure 5 in 8 weeks rather than 10 weeks. In this case you could look at using two analysts in activities 2 to 3 and 3 to 4. This would shorten the project by two weeks, but may raise the project cost – doubling resources at any stage may only improve productivity by, say, 50% as additional time may need to be spent getting the team members up to speed on what is required, coordinating tasks split between them, integrating their contributions etc.

In some situations, shortening the original critical path of a project can lead to a different series of activities becoming the critical path. For example, if activity 4 to 5 were reduced to 1 week, activities 4 to 8 and 8 to 6 would come onto the critical path.

PERT (Program Evaluation and Review Technique)

PERT is a variation on Critical Path Analysis that takes a slightly more skeptical view of time estimates made for each project stage. To use it, estimate the shortest possible time each activity will take, the most likely length of time, and the longest time that might be taken if the activity takes longer than expected.

Use the formula below to calculate the time to use for each project stage:

$$\frac{\text{shortest time} + 4 \times \text{likely time} + \text{longest time}}{6}$$

This helps to bias time estimates away from the unrealistically short time-scales normally assumed.

Illustration 5.

XYZ Auto-manufacturing company has to prepare a design of its latest model of motorcycle. The various activities to be performed to prepare design are as follows:

Activity	Description of activity	Preceding activity
A	Prepare drawing	—
B	Carry out cost analysis	A
C	Carry out financial analysis	A
D	Manufacture tools	C
E	Prepare bill of material	B, C
F	Receive material	D, E
G	Order sub-accessories	E
H	Receive sub-accessories	G
I	Manufacture components	F
J	Final assembly	I, H
K	Testing and shipment	J

Prepare an appropriate network diagram.

Solution:

The network diagram will be as follows:

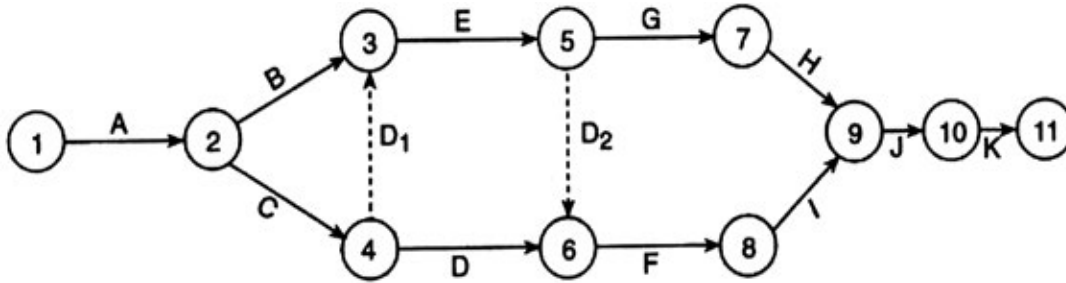

Where D_1 and D_2 are dummy activities.

Illustration 6.

The following table gives data on normal time & cost and crash time & cost for a project.

Activity	Normal		Crash	
	Time (days)	Cost (₹)	Time (days)	Cost (₹)
1—2	6	600	4	1,000
1—3	4	600	2	2,000
2—4	5	500	3	1,500
2—5	3	450	1	650
3—4	6	900	4	2,000
4—6	8	800	4	3,000
5—6	4	400	2	1,000
6—7	3	450	2	800

The indirect cost per day is ₹ 100.

- Draw the network and identify the critical path.
- What are the normal project duration and associated cost?
- Crash the relevant activities systematically and determine the optimum project completion time and cost.

Solution:

- The network for normal activity times indicates a project time of 22 days with the critical path 1-2-4-6-7.

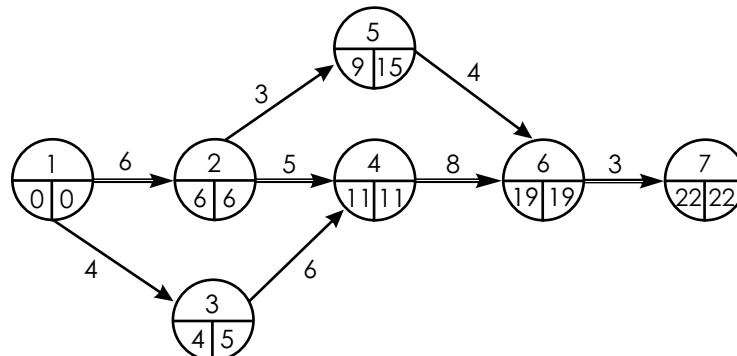



(ii) Normal project duration is 22 days and the associated cost is as follows:

$$\begin{aligned} \text{Total cost} &= \text{Direct normal cost} + \text{Indirect cost for 22 days.} \\ &= 4,700 + 100 \times 22 = ₹ 6,900. \end{aligned}$$

(iii) For critical activities, cost - slope is given below:

Critical activity	Cost-slope* (₹/day)
1-2	$\frac{1000 - 600}{6 - 4} = 200$
2-4	$\frac{1500 - 500}{5 - 3} = 500$
4-6	$\frac{3000 - 800}{8 - 4} = 550$
6-7	$\frac{800 - 450}{3 - 2} = 350$

$$* \text{ Cost slope} = \frac{\text{Crash Cost} - \text{Normal Cost}}{\text{Normal Time} - \text{Crash Time}}$$

Of the activities lying on the critical path, activity 1—2 has lowest cost slope Therefore, we shall first crash this activity by just one day.

$$\text{Duration} = 21 \text{ days, and cost} = 4700 + 1 \times 200 + 100 \times 21 = ₹ 7000.$$

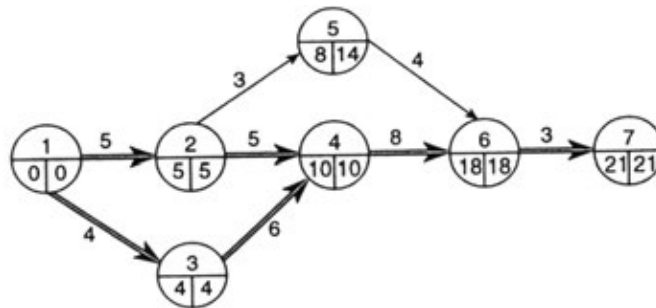

Other activities too have become critical. Now we have 2 critical paths:

1→2→4→6→7 and 1→3→4→6→7.

To reduce duration of the activity further, we shall have to reduce duration of both the paths. We have following alternatives:

Crash activity 6 — 7 by 1 day at a cost of ₹ 350.

Crash activity 4 — 6 by 4 days at the cost of ₹ 550 per day.

Crash activities 1—2 and 1 — 3 by 1 day each at a cost of ₹ (200 + 700) = ₹ 900.

Crash activities 2 — 4 and 3 — 4 by 2 days each at a cost of ₹ (500 + 550) = ₹ 1050/day.

Thus, we shall first crash activities 6 — 7 by 1 day and then activity 4 — 6 by 4 days.

On crashing activity 6 — 7 by 1 day, cost = 4900 + 350 x 1 + 100 x 20 = ₹ 7250, and duration = 20 days. Next we crash 4—6 by 4 days.

$$\text{Cost} = 5250 + 550 \times 4 + 100 \times 16 = ₹ 9050. \text{ Duration} = 16 \text{ days.}$$

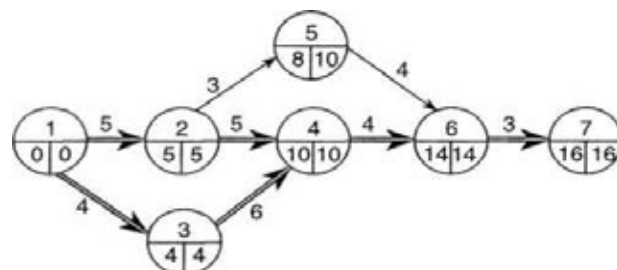



Next we crash activities 1—2 and 3—4 by 1 day each.

Cost = 7450 + 200 x 1 + 550 x 1 + 100 x 15 = ₹ 9700.

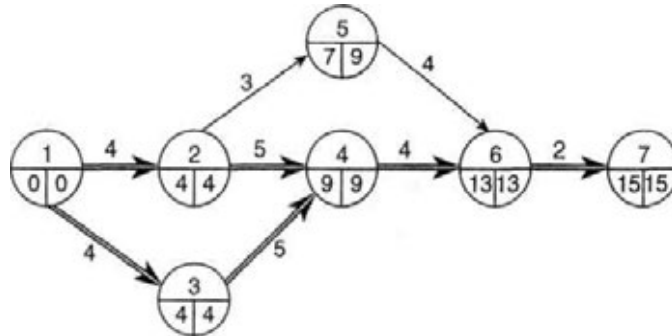

Next we crash activities 2 → 4 and 3 → 4 by 1 day each.

Cost = 8200 + 500 x 1 + 550 x 1 + 100 x 14 = ₹ 10,650. Duration = 14 days.

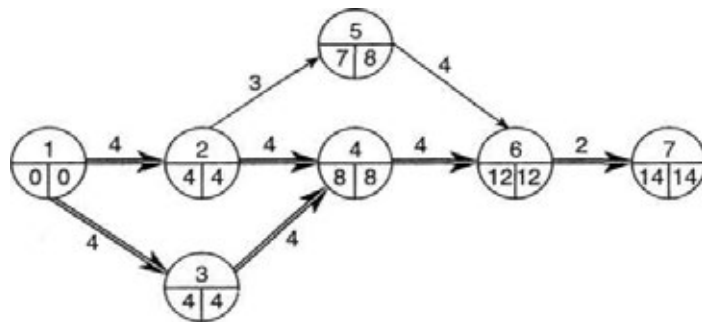

We crash activities 1—3 and 2—4 by 1 day each.

Cost = 9250 + 700 x 1 + 500 x 1 + 100 x 13 = ₹ 11,750 Duration = 13 days.

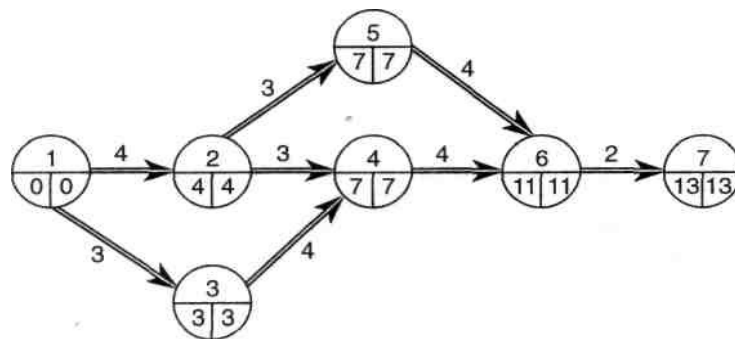

Now there are three critical paths:

1—2—5—6—7, 1—2—4—6—7, 1—3—4—6—7

Also, no further crashing is possible. Hence minimum duration of the project = 13 days with cost ₹ 11,750

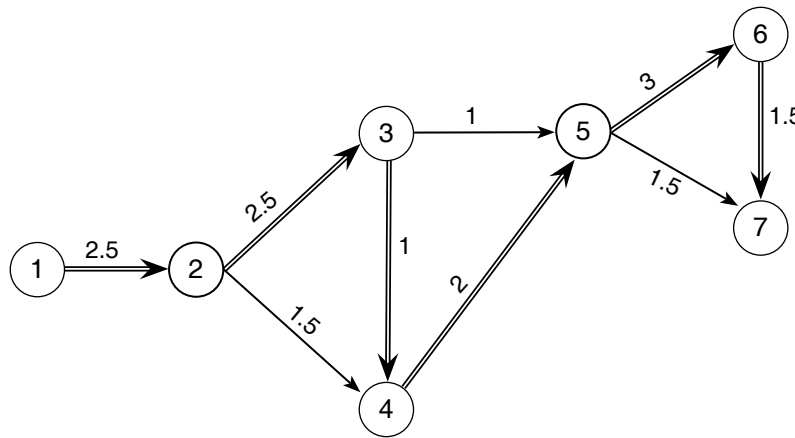

Illustration 7.

Draw the network for the following activities and find critical path and total duration of project.

Activity	Duration (months)	Activity	Duration (months)
1-2	2.5	4-5	2.0
2-3	2.5	5-6	3.0
2-4	1.5	6-7	1.5
3-4	1.0	5-7	1.5
3-5	1.0		

Answer:



Paths	Duration
1-2-3-5-6-7	2.5+2.5+1+3+1.5 = 10.5
1-2-3-5-7	2.5+2.5+1+1.5 = 7.50
1-2-3-4-5-6-7	2.5+2.5+1+2+3+1.5 = 12.5 (Critical path)
1-2-3-4-5-7	2.5+2.5+1+2+1.5 = 9.5
1-2-4-5-7	2.5+1.5+2+1.5 = 7.5
1-2-4-5-6-7	2.5+1.5+2+3+1.5 = 10.5

Illustration 8.

The following activities must be accomplished in order to complete a construction project:

Activity	A	B	C	D	E	F	G	H	I	J
Time	3	8	4	2	1	7	5	6	8	9
Predecessors	—	—	AB	B	A	C	EF	DF	GH	I

- Construct a network diagram for this project. Find the CP and the duration of the project.
- Assume that you are project manager of the project mentioned above. The project has progressed for 10 weeks and the status is follows:

Activities completed: A, B, E. Other activities have not started as yet.

- ❖ If no managerial action is taken at all when will the project get completed?
- ❖ What action might you take to get the project back to a schedule that can be completed by the end of week 42?



Answer:

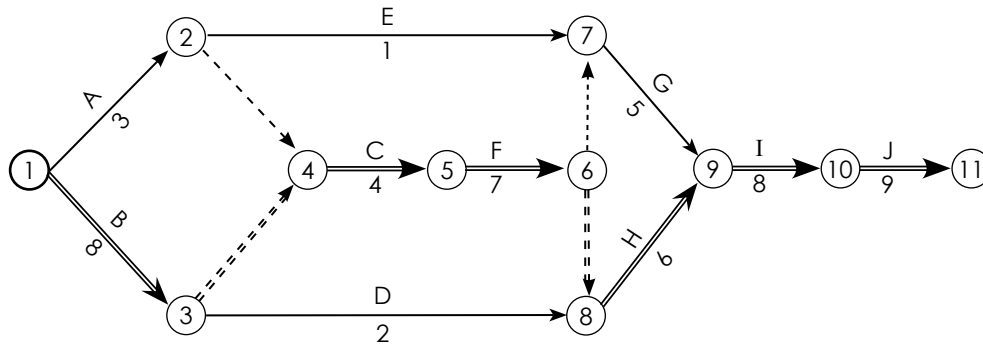

Paths	Duration (weeks)	Paths	Duration (weeks)
1-2-7-9-10-11	26	1-3-4-5-6-7-9-10-11	41
1-2-4-5-6-7-9-10-11	36	1-3-4-5-6-8-9-10-11	42
1-2-4-5-6-8-9-10-11	37	1-3-8-9-10-11	33
Critical Path: BCFHIJ. Duration 42 weeks.			

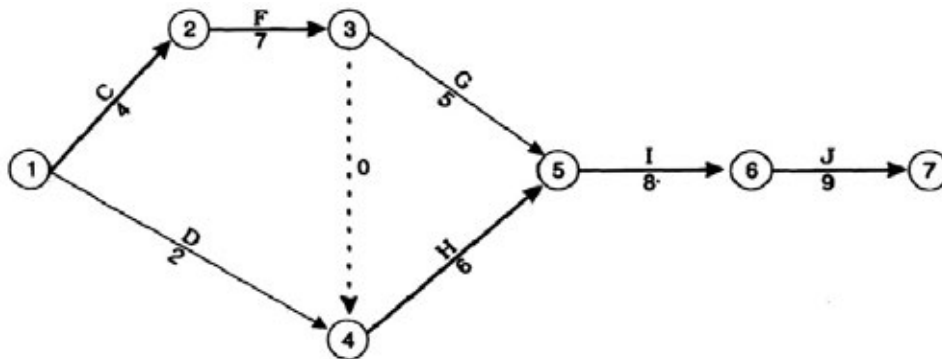

Paths	1-2-3-5-6-7	1-2-3-4-5-6-7	1-4-5-6-7
Duration (weeks)	33	34	25
Critical Path: CFHIJ			

For completing the project as per original schedule, the project activities on the critical path should be reduced by 2 weeks. For example, we may reduce any one of the activities CFHIJ by 2 weeks or any two activities by one week each.

Illustration 9.

Given is the following information regarding a project:

Activity	A	B	C	D	E	F	G	H	I	J	K	L
Dependence	-	-	-	AB	B	B	FC	B	EH	EH	CDFJ	K
Duration	3	4	2	5	1	3	6	4	4	2	1	5

Draw the Network Diagram and identify the Critical Path and Project Duration.



Answer:

Network Diagram:

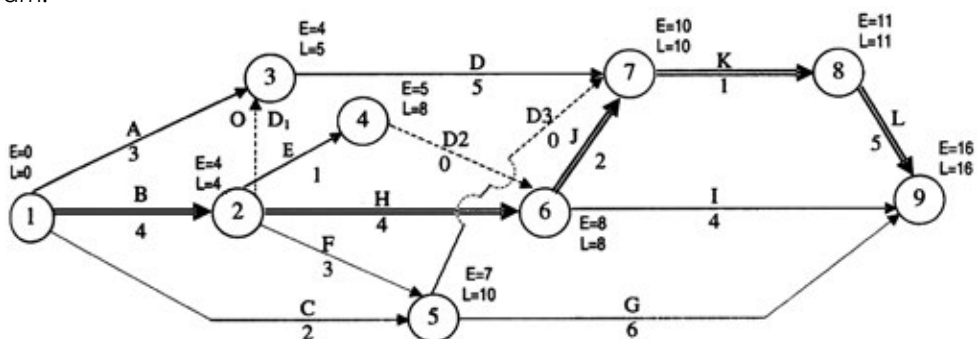

Network Table:

Activity	Duration	EST	LST	EFT	LFT	Total Float	Free Float	Independent Float
(1)	(2)	(3)	(4)	(5)	(6)	(7)	(8)	(9)
A	3	0	2	3	5	2	2 - 1 = 1	1 - 0 = 1
B	4	0	0	4	4	0	0	0
C	2	0	8	2	10	8	8 - 3 = 5	5 - 0 = 5
D1	0	4	5	4	5	1	1 - 1 = 0	0
D	5	4	5	9	10	1	1 - 0 = 1	1 - 1 = 0
E	1	4	7	5	8	3	3 - 3 = 0	0
F	3	4	7	7	10	3	3 - 3 = 0	0
G	6	7	10	13	16	3	3 - 0 = 3	3 - 3 = 0
D2	0	5	8	5	8	3	3 - 0 = 3	3 - 3 = 0
H	4	4	4	8	8	0	0	0
I	4	8	12	12	16	4	4 - 0 = 4	4 - 0 = 4
J	2	8	8	10	10	0	0	0
D3	0	7	10	7	10	3	3 - 0 = 3	3 - 3 = 0
K	1	10	10	11	11	0	0	0
L	5	11	16	16	16	0	0	0

Critical path is B – H – J – K – L. Expected Duration = 16days

The columns are updated in the following order as under:

- (1) Activity (including Dummies) are listed from the Question and network Diagram
- (2) Duration (including Dummies) are listed from the Question and Network Diagram
- (3) EST = E value of LHS/ Tail Event from Diagram.
- (6) LFT = L value of RHS/ Head Event from Diagram.
- (5) EFT = EST + Duration as per Column (2). Hence Column (5) = Column (3) + Column (2)
- (4) LST = LFT - Duration as per Column (2). Hence column (4) = Column (6) – Column (2)
- (7) Total Float = [LET – EFT] or [LST – EST] = [Col.(6) – Col.(5)] or [Col.(4) – Col.(3)]
- (8) Free Float = Total Float – Head Event Slack i.e. [Col.(7) – difference between L and E of RHS Event].
Note: If Total Float is Zero, Free Float is also equal to Zero. If a negative value is derived, it is restricted to zero.
- (9) Independent Float = Free Float – Tail Event Slack i.e. [Col (8) – Difference between L and E of LHS Event].
Note: If Free Float is Zero, Independent Float is also equal to Zero. If a negative value is derived, it is restricted to zero.



Note:

- The activities whose Total Float is Zero are Critical Activities. These Total Floats are circled and the respective activities are indicated by double in the network diagram.
- Dummy Activities may or may not lie on the critical path. However, in this question, the dummy activities do not fall on the Critical Path.

Illustration 10.

A project with normal duration and cost along with crash duration and cost for each activity is given below:

Activity	Normal time (Hrs.)	Normal cost (₹)	Crash time (Hrs.)	Crash cost (₹)
1-2	5	200	4	300
2-3	5	30	5	30
2-4	9	320	7	480
2-5	12	620	10	710
3-5	6	150	5	200
4-5	0	0	0	0
5-6	8	220	6	310
6-7	6	300	5	370

Overhead cost is ₹ 50 per hour.

Required:

Draw network diagram and identify the critical path.

Answer:

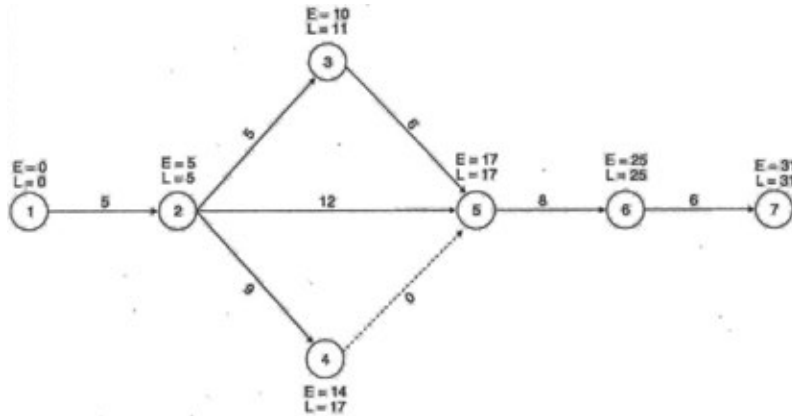

Paths →	1-2-5-6-7 (Let's denote this by A)	1-2-3-5-6-7 (Let's denote this by B)	1-2-4-5-6-7 (Let's denote this by C)
Duration	31 hours	30 hours	28 hours
The critical path is A. Its duration is 31 hours			

Illustration 11.

What are the difference between CPM and PERT.

Answer:

CPM originated from construction project while PERT evolved from R & D projects. Both CPM and PERT share the same approach for constructing the project network and for determining the critical path of the network.

There is some basic differences between PERT and CPM

PERT	CPM
1. Time estimate is probabilistic with uncertainty in time duration. Three time estimates.	1. Time estimate is deterministic with known time durations. Single time estimate
2. Event oriented	2. Activity oriented
3. Focused on time	3. Focused on time-cost trade off
4. More suitable for new projects	4. More suited for repetitive projects

Study Note - 7

ECONOMICS OF MAINTENANCE AND SPARES MANAGEMENT



This Study Note includes

- 7.1 Break Down Maintenance
- 7.2 Preventive Maintenance
- 7.3 Routine Maintenance
- 7.4 Replacement of Machine
- 7.5 Spare Parts Management

7.1 BREAK DOWN MAINTENANCE

Here the production facility is run without much routine maintenance until it is breakdown. Once the machine breakdown it is taken for repair and inspected to find out the defects. After identifying the defect, the required repair is planned and the spares are procured to repair the machine. As the breakdowns are random in nature and the machine cannot be used during the repair period, production hours are lost hence the productivity is reduced. Repair maintenance is not a recommended practice, in general, but many a time many organizations prefer this, because they do not want to keep the machine idle for maintenance. But they ignore the fact that the break down repair costs more than the regular maintenance practice. It is however, an economical way of maintaining certain non-critical items whose repair and down time costs are less this way than with any other system of maintenance.

7.2 PREVENTIVE MAINTENANCE

A system of scheduled, planned or preventive maintenance tries to minimize the problems of breakdown maintenance. It locates weak parts in all equipments, provides them regular inspection and minor repairs thereby reducing the danger of unanticipated breakdowns. The underlying principle of preventive maintenance is that prevention is better than cure. It involves periodic inspection of equipment and machinery to uncover conditions that lead to production breakdown and harmful depreciation. The system of preventive maintenance varies from plant to plant depending on the requirement of the plant. Any company, adopting the preventive maintenance should keep the record of failure of various components and equipment, which help the maintenance department to statistically analyze the failure pattern and replace the item before it fails, so that the breakdown can be eliminated. This reduces the unanticipated breakdowns, increases the availability of the equipment for production purpose, maintain optimum productive efficiency of equipment and machinery reduces the work content of maintenance job, increases productivity and safety of life of worker.

Production department or maintenance department depending on the size of the plant generally takes up preventive maintenance work. As the preventive maintenance is a costly affair, it is better to maintain records of cost (both labour, materials used and spares used) and a valuation of the work done by the department will show us what benefits are derived from preventive maintenance. The analytical approach to evaluate the work done by preventive maintenance is

- (i) $(\text{Inspections incomplete}) / (\text{Inspections scheduled}) \times 100$ should be less than 10%
- (ii) $(\text{Hours worked for maintenance}) / (\text{Scheduled hours}) \times 100 = \text{Performance of the department.}$
- (iii) Down time to be given as a ratio of the available hours and to be compared against a standard to be worked out for each company or against a figure of the past. The ratio is given as:
$$= \text{Down time in hours} / \text{Available hours (where Available Hours} = \text{working days} \times \text{hours per day} \times \text{number of machines). Here down time is the total time of stoppage of the machine for scheduled and unscheduled maintenance work.}$$



- (iv) Frequency of break downs = (Number of break downs) / (Available machine hours)
- (v) Effectiveness of planning = (Labour hours on scheduled maintenance) / (Total labour hours spent on maintenance).

OR

(Down time due to scheduled maintenance)/(Down time due to total maintenance work)

Advantages of preventive maintenance:

- (i) Reduced breakdowns and downtime,
- (ii) Greater safety to workers,
- (iii) Fewer large scale repairs,
- (iv) Less standby or reserve equipment or spares,
- (v) Lower unit cost of the product manufactured,
- (vi) Better product quality,
- (vii) Increased equipments life and
- (viii) Better industrial relations.

7.3 ROUTINE MAINTENANCE

It includes lubrication, cleaning, periodic overhaul; etc. This is done while the equipment is running or during pre-planned shut-downs. Running maintenance is the work which can be carried out while the facility is in service.

Maintenance Techniques

It can be discussed as under:

In some cases the loss and inconvenience due to breakdown of equipment is so high that standby equipment is kept. As soon as the original equipment fails, the standby facility is employed to avoid interruption and downtime. Standby machines are often kept to reduce the loss due to the breakdown of a key machine. Breakdown maintenance also requires use of standby machines. The main question here is how many standby machines to keep and for how long. In order to decide this, a cost benefit analysis of standby machines should be made. There are various costs involved in standby machines. First, there is interest cost on capital investment. Secondly, space is needed to keep standby machines. Thirdly, there is depreciation in the value of standby machines. Fourthly, periodic checking and servicing is necessary to keep the standby machines in good condition. The benefits of standby machines consist of protection against a complete shutdown or shut down of operations. It avoids loss of production and, therefore, it is necessary to estimate loss of future failures a table of expected costs and benefits can be prepared.

Shifting production during breakdown. Under this method spare capacity is maintained not in the form of standby machines but by allowing rest to running machines at intervals and by rotation. If one machine in a production line requires shutdown, the output is maintained by shifting to under utilised machines in other lines. For such application, the capacities of different machines must be properly matched.

Maintenance Organization

At least 50 to 60 percent of investment of any organization is spent on Building and Production facilities. Hence, it is worthwhile to give due consideration for effective maintenance of these items. The maintenance department will look after the upkeep of equipments, buildings and other. For effective contribution of its work, the maintenance department must have proper place in the organization and it must also have a good organizational structure. While organizing a maintenance department one must remember that there should be clear division of authority with little or no overlap. Vertical lines of authority and responsibility must be kept as short as possible. Keep the span

of control to an extent of 3 to 6 for a manager. The organizational structure should be flexible. The structure should be designed to suit the types of maintenance work involved. Depending on the need, the maintenance activity may be centralized or decentralized.

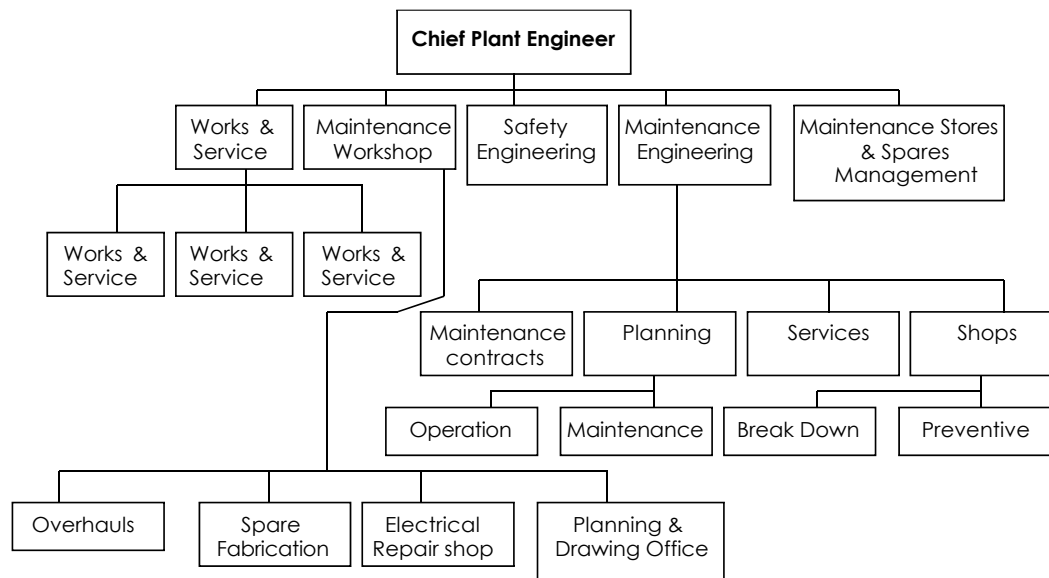

Outline of a maintenance department of a large organisation

Organizing Maintenance Work

In order to facilitate proper control of maintenance work; we must enforce three rules as below.

Maintenance Request

This must be made in writing to a central point in the organization. No work should be carried out without the knowledge and approval of maintenance supervisor - if this discipline is not followed by the organization, it leads to wastage of skilled manpower and inability of the maintenance personnel to schedule essential maintenance work.

Maintenance Stores

Non-availability of vital spare parts when required to meet an emergency like breakdown, may lead to excessive shutdown of the plant and equipment. A large number of items or materials are required to be stored and it involves investing valuable funds from the working capital. A proper stores management is essential as a backup service of good maintenance.

Records of Maintenance Work Done

Paper work for maintenance is crucial for establishing a good maintenance organization and is often neglected. The records of maintenance work carried out from time to time have to be kept equipment wise. History cards or logbooks of all the plants and equipment must be compiled meticulously giving details of materials used, components replaced and time spent by the workforce.

Creation and maintaining this database is essential for proper planning and control, which alone will lead to effective and efficient maintenance.

To get the full benefits of effective maintenance the following requirement is to be fulfilled:

(i) Good Supervision and administration of maintenance department, (ii) Good and clear instructions to be given to maintenance crew regarding the repair, (iii) Proper control of work in coordination with production department,



(iv) Good training should be given to the maintenance personnel, (v) Good scheduled maintenance program should be chalked out, (vi) Proper maintenance record keeping is a must, (vii) There should be adequate stock of spare parts, particularly insurance spares.

Maintenance Problem

The main problem in maintenance analysis is to minimise the overall cost of maintenance without sacrificing the objectives. There are two alternatives before management. One is to repair a machine or equipment only when it breaks down. This will save expense of inspection and replacement of a part before its lifetime ends. The other alternative is to replace the equipment before the expiry of its working life. This will involve cost of periodic shutdown for check up and repairs. However, it will avoid the loss due to sudden failure or breakdown.

The two types of cost - cost of premature replacement and cost of breakdown - need to be balanced. The objective is to minimise total maintenance cost and downtime. Economic analysis is helpful in finding a judicious combination of two types of maintenance. The relationship between preventive maintenance time and repair time is also significant. Preventive maintenance policy is justified only when the average downtime and its cost is less than the average time taken to carry out breakdown repairs. If the machine happens to be part of production line, the breakdown of a machine would throw the entire production line out of gear while a preventive maintenance schedule might enable the repair to be performed during a scheduled idle time of the line.

7.4 REPLACEMENT OF MACHINE

Wear and obsolescence are the two main causes for replacement of machinery in every aspect of life. The reduction of wear is therefore a primary concern while designing appliances. Wear and tear due to passage of time and/or normal usage of plant and machinery is an accepted fact. Technological obsolescence is a major danger which business firms face in modern era. With the development of new and better techniques or equipment of performing a particular function, existing equipment and machines become uneconomical. Whenever a firm decides to switch over to new machines or improved product designs, existing machine designs are said to be obsolete. Hence, obsolescence is a major issue in the procurement and installation of machinery and equipment. A machine is technically obsolete when another machine can do the same job more efficiently, with reduced time and also at a lower cost. Technological obsolescence arises due to continuous improvements in the methods and techniques of production and sometime the rate of improvement is so fast that it becomes economical to replace the machinery before its expected life. A machine may be replaced to reduce the running costs of the concerned machine and the new machines productivity will be more. In replacement decisions, the basic problem is to decide whether to replace a machine or equipment at present or at a future date. It is, therefore, necessary to determine whether obsolescence or deterioration has reached the point where the reduction in operating costs expected from replacement justifies the net capital expenditure involved in installing the new machine and disposing of the old one.

Any function aimed at bringing back or restoring an item to its original or acceptable condition or to keep it and retain its health as well as workability is known as Maintenance.

Objectives of Maintenance:

The objectives of maintenance are : (i) To keep all the production facilities and other allied facilities such as building and premises, power supply system, etc in an optimum working condition, (ii) To ensure specified accuracy to products and time schedule of delivery to customers, (iii) To keep the down time of the machine at minimum, so that the production program is not disturbed, (iv) To keep the production cycle within the stipulated range, (v) To modify the machine tools to meet the augmented need for production, (vi) To improve productivity of existing machine tools and to avoid sinking of additional capital, (vii) To keep the maintenance cost at a minimum as far as possible, thereby keeping the factory Overheads at minimum, (viii) To extend the useful life of plant and machinery, without sacrificing the level of performance.

**Illustration 1.**

A workshop has 20 nos. of identical machines. The failure pattern of the machine is given below:-

Elapsed time after Maintenance attention (in month)	Probability of failure
1	0.20
2	0.15
3	0.15
4	0.15
5	0.15
6	0.20

It costs ₹ 150 to attend a failed machine and rectify the same. Compute the yearly cost of servicing the broken down machines.

Solution:

Expected time before failure.

$$= 0.20 \times 1 + 0.15 \times 2 + 0.15 \times 3 + 0.15 \times 4 + 0.15 \times 5 + 0.20 \times 6 = 3.5 \text{ months}$$

Therefore number of repair/machine/annum = $12/3.5$

Considering 20 machines and ₹ 150 to attend a failed machine the yearly cost of servicing

$$= 12/3.5 \times 20 \times 150 = ₹ 10286.$$

Illustration 2.

A Public transport system is experiencing the following number of breakdowns for months over the past 2 years in their new fleet of vehicles:

Number of breakdowns	0	1	2	3	4
Number of months this occurred	2	8	10	3	1

Each break down costs the firm an average of ₹ 2,800. For a cost of ₹ 1,500 per month, preventive maintenance can be carried out to limit the breakdowns to an average of one per month. Which policy is suitable for the firm?

Solution:

Converting the frequencies to a probability distribution and determining the expected cost/month of breakdowns we get:

No. of breakdowns (x)	Frequency in months (f)	Probability (p = f/Σf)	Expected no. of breakdowns (px)
0	2	0.083	0.000
1	8	0.333	0.333
2	10	0.417	0.834
3	3	0.125	0.375
4	1	0.042	0.168
	Σf = 24	Σp = 1	Total 1.710 = Σpx



Expected Breakdown cost per month; Expected no. of breakdowns per month \times cost of each breakdown = $1.710 \times ₹ 2800 = ₹ 4788$.

Preventive maintenance cost per month: -

Average cost of one breakdown/month = ₹ 2,800

Maintenance contract cost/month = ₹ 1,500

Total = ₹ 4,300

Thus, preventive maintenance policy is suitable for the firm.

Illustration 3.

Indian Electronics, manufactures TV sets and carries out the picture tube testing for 2000 hours. A sample of 100 tubes was put through this quality test during which two tubes failed. If the average usage of TV by the customer is 4 hours/day and if 10,000 TV sets were sold, then in one year how many tubes were expected to fail and what is the mean time between failures for these tubes?

Solution:

The total test time = (100 tubes) \times 2000 hours = 200,000 tube-hours.

There are two tubes which have failed and hence the total time is to be adjusted for the number of hours lost due to the failures during the testing.

The lost hours are computed as = $2 \times \frac{2000}{2} = 2000$ hours.

The assumption is made here is that each of the failed tubes have lasted an average of half of the test period.

Therefore, the test shows that there are two failures during (2,00,000 – 2000) = 1,98,000 tube hours of testing.

During 365 days a year (four hours a day) for 10,000 tubes the number of expected failures

$\frac{2}{1,98,000} \times 10,000 \times 365 \times 4 = 147.47 = 148$ tubes approximately.

Mean time between failures = $\frac{1,98,000 \text{ tubes hrs. of testing}}{2 \text{ failure}}$

= 99,000 tubes hours per failure = $\frac{99,000}{4 \times 365} = 67.8$ tubes year per failure

Illustration 4.

A company has 50 identical machines in its facilities. The cost of preventive servicing (C_p) is ₹ 20, and the cost of repair after breakdown (CR) is ₹ 100. The company seeks the minimum cost preventive servicing frequency and has collected the data on breakdown probabilities in the following table:

Probabilities of machine breakdown, by month:

Months after servicing that breakdown occurs (i)	Probability that breakdown will occur (Pi)	i.P _i
1	0.10	0.10
2	0.05	0.10
3	0.05	0.15
4	0.10	0.40
5	0.15	0.75
6	0.15	0.90
7	0.20	1.40
8	0.20	1.60
Total	1.00	5.40

**Solution:**

The mean time before failure is 5.4 months and the expected cost with no preventive maintenance would be $100 \times \frac{50}{5.4} = ₹ 925.93$ per month. The following calculations show B_j , the expected number of breakdowns between preventive maintenance intervals, for the possible intervals, that may be considered.

$$B_1 = MP_1 = 50 (0.10) = 5$$

$$B_2 = m (P_1 + P_2) + B_1 P_1 = 50(0.10+0.05) + 5(0.10) = 8$$

$$B_3 = 50 (0.10 + 0.05 + 0.05) + 8 (0.10) + 5 (0.05) = 11.05$$

Accordingly, $B_4 = 16.75$, $B_5 = 25.63$, $B_6 = 35.5$, $B_7 = 48.72$, $B_8 = 63.46$.

The costs of various preventive maintenance intervals are summarised in the table below :

Cost of alternative preventive maintenance intervals –

Number of months between preventive services (j)	B_j Expected Number of Breakdown in j months	Expected cost/month to Repair Breakdown $C_R \times B_j/j$	Cost per month for preventive service every j month $C_R(M)/j$	Total expected cost per month of preventive maintenance and repair
(1)	(2)	(3)	(4)	(5)
1	5.00	500.00	1000.00	1500.00
2	8.00	400.00	500.00	900.00
3	11.05	368.33	333.33	701.66
4	16.75	418.75	250.00	668.75
5	25.63	512.60	200.00	712.60
6	35.50	591.67	166.67	758.34
7	48.72	696.00	142.86	838.86
8	63.46	793.25	125.00	918.25

A policy of performing preventive maintenance every 4 months results in the lowest average cost, about ₹ 669. This amount is ₹ 257 per month less than the ₹ 926 expected cost without preventive maintenance. This policy would reduce the costs by $(257 \div 926) \times 100 = 27.75\%$ below the cost of repairing the machines only when they breakdown.

7.5 SPARE PARTS MANAGEMENT

In manufacturing plants that own a huge number of equipment, supervising the spare parts correctly and in a timely manner is a difficult task. Usually, spare parts are categorized into two main groups

- fast moving
- slow moving parts.

Fast moving spares are those that are usually required, and slow moving spares are those that are hardly ever required. The managers come across in difficulties to keep track of the spare parts used and determine future demand manually. The main objective of this project is to create a database management system that will help the managers with the process of supervising spare parts. The system should do the following to keep track.

- (a) keep record of the spare parts required for a particular type of maintenance;
- (b) keep record of the spare parts received and used in the past;
- (c) schedule forthcoming major maintenance services;
- (d) keep record of spare parts vendors;
- (e) forecast future demand for fast moving spare parts based on past consumptions; etc.

Preventive maintenance is very important but failure cannot be able to eliminated. To avoid failures spare parts play a vital role. Failure statistics are usefull in calculating spare parts for preventive maintenance and breakdown maintenance also. Spares can be classified as per sevice level/understocking cost.



- **Regular spares**

The spare parts required regularly and in substantial number. Both reliability and per unit cost of these items are less.

Service level = $K_u / (K_u + K_o)$, K_u = Opportunity cost of understock of one unit K_o = Opportunity cost of overstock of one unit.

- **Insurance spares**

An insurance spare is a spare part that you hold in your spare parts inventory, that you would not expect to use in the normal life of the plant and equipment but if not available when needed it would result in significant losses.

- **Capital spares**

Capital spares are spare parts which, although acknowledged to have a long life or a small chance of failure, would cause a long shutdown of equipment because it would take along time to get a replacement for them.

$$\sum_{i=0}^{N-1} P_i \leq C_3 - C / C_3 \leq \sum P_i$$

- **Rotable spares**

Rotable items are generally thought of as items of plant or assets that periodically are changed out for repair or overall.

The management of rotable items and repairable spare parts is different to the management of other inventory items and proper control requires greater cooperation between maintenance and stores/inventory management. The successful management of these items is far more active than other spare parts as maintenance and store/inventory personnel must work together to ensure that there is visibility of the status of items.

Illustration 5.

Compute the requirement of spares for breakdown maintenance for an item that exhibits a Poissonian behavior for failure rates with a mean breakdown rate of five items per month. If the lead time for procuring these spares is one month and a service level of 90 per cent is to be used, what buffer stock of these items should be maintained? (A fixed re-order quantity system of inventory is being used).

Solution:

Buffer stock is required to cover the lead time only, i.e. to cover one month's period.

Mean consumption rate, = 5 per month

Referring to the Poisson distribution table for $\lambda = 5$, we have for

$x = 7$... Cumulative probability = 0.867

$x = 8$... Cumulative probability = 0.932

Thus, with seven items only 86.7 per cent service level is attained; with eight items 93.2 per cent service level is obtained. Since one would err on the higher side of the service level, the value of $x = 8$ is chosen.

This means, the amount of spares stock that has to be kept must correspond to a maximum demand rate D_{max} of eight during the lead time. In other words we should keep a Buffer Stock = $D_{max} - D_{average}$

during a lead time = $8 - 5 = 3$ items.

Thus, buffer stock desired is three numbers of the given spare part.

Illustration 6.

The main shaft of an equipment has a very high reliability of 0.990. The equipment comes from Russia and has a high downtime cost associated with the failure of this shaft. This is estimated at ₹ 2 crore as the costs of sales lost and other relevant costs. However, this spare is quoted at ₹ 10 lakh at present. Should the shaft spare be procured along with the equipment and kept or not?

Solution:

The expected cost of down-time

= (Probability of failure) × (Cost when break-down occurs)

= $(1 - 0.990) \times (\text{₹ } 2 \text{ crore}) = \text{₹ } 2 \text{ lakh}$

However, the cost of procuring the spare now is ₹ 10 lakh. Therefore, expected cost of downtime is less than the cost of spare; hence the spare need not be bought along with the equipment.

**SOME MORE EXAMPLE:****Illustration 7.**

PQR company has kept records of breakdowns of its machines for 300 days work year as shown below:

No. of breakdown	Frequency in days
0	40
1	150
2	70
3	30
4	10
	300

The firm estimates that each breakdown costs ₹ 650 and is considering adopting a preventive maintenance program which would cost ₹ 200 per day and limit the number of breakdown to an average of one per day. What is the expected annual savings from preventive maintenance program?

Solution :

Step 1 : To determine the expected number of breakdowns per year:

No. of breakdowns (x)	Frequency of breakdowns in days i.e, f(x)	Probability distribution of breakdowns P(x)	Expected value of breakdowns X P(x)
0	40	$40/300 = 0.133$	Nil
1	150	$150/300 = 0.500$	0.500
2	70	$70/300 = 0.233$	0.466
3	30	$30/300 = 0.100$	0.300
4	10	$10/300 = 0.033$	0.132
Total	300	1.000	1.400

Step 2 :

Total no. of breakdowns per day = 1.40

Cost of breakdown per day = $1.40 \times 650 = ₹ 910$

Cost of preventive maintenance programme per day = ₹ 200 + ₹ 650 = ₹ 850

Expected annual savings from the preventive maintenance programme = $(910 - 850) \times 300$ days

= $60 \times 300 = ₹ 18,000$

Illustration 8.

A firm is using a machine whose purchase price is ₹ 15,000. The installation charges amount to ₹ 3,500 and the machine has a scrap value of only ₹ 1,500 because the firm has a monopoly of this type of work. The maintenance cost in various years is given in the following table:

Year	1	2	3	4	5	6	7	8	9
Maintenance Cost (₹)	260	760	1100	1600	2200	3000	4100	4900	6100

The firm wants to determine after how many years should the machine be replaced on economic considerations, assuming that the machine replacement can be done only at the year end.

**Answer:**

Cost of machine, $C = ₹ 15,000 + ₹ 3,500 = ₹ 18,500$

Scrap value, $S = ₹ 1,500$.

Year	Maintenance Cost, M_1 (₹)	Cumulative Maintenance Cost, ΣM_1 (₹)	Cost of Machine – Scrap Value (₹)	Total Cost $T_{(n)}$ (₹)	Annual Cost $A_{(n)}$ (₹)
(i)	(ii)	(iii)	(iv)	(v) = (iii) + (iv)	(vi) = (v) / n
1	260	260	17,000	17,260	17,260
2	760	1,020	17,000	18,020	9,010
3	1,100	2,120	17,000	19,120	6,373
4	1,600	3,720	17,000	20,720	5,180
5	2,200	5,920	17,000	22,920	4,584
6	3,000	8,920	17,000	25,920	4,320
7	4,100	13,020	17,000	30,020	4,288*
8	4,900	17,920	17,000	34,920	4,365
9	6,100	24,020	17,000	41,020	4,557

Lowest average cost is ₹4,288 approx., which corresponds to $n = 7$ in above table. Thus machine needs to be replaced every 7th year.

Illustration 9.

A large computer installation contains 2,000 components of identical nature which are subject to failure as per probability distribution that follows:

Month End:	1	2	3	4	5
% Failure to date:	10	25	50	80	100

Components which fail have to be replaced for efficient functioning of the system. If they are replaced as and when failures occur, the cost of replacement per unit is ₹3. Alternatively, if all components are replaced in one lot at periodical intervals and individually replace only such failures as occur between group replacement, the cost of component replaced is ₹ 1.

- Assess which policy of replacement would be economical.
- If group replacement is economical at current costs, then assess at what cost of individual replacement would group replacement be uneconomical.
- How high can the cost per unit in-group replacement be to make a preference for individual replacement policy?



Solution:

(a) Computation of failures & Mean life

Month (X_i)	Probability of Failure (P_i)	$P_i X_i$
1	0.10	0.10
2	0.15	0.30
3	0.25	0.75
4	0.30	1.20
5	0.20	1.00
		$\sum p_i X_i = 3.35$ month

Average Life of a component = 3.35 Months

Average No. of Replacements = $2000/3.35 = 597$ per month

Cost of Individual Replacement = $597 \times ₹ 3 = ₹ 1791$ per month

Computation of expected No. of Replacements:

Month	Expected number of components to be replaced by the month end	
1	$N_1 = N_0 P_1 = 2000 \times 0.1$	200
2	$N_2 = N_0 P_2 + N_1 P_1 = 2000 \times 0.15 + 200 \times 0.1$	320
3	$N_3 = N_0 P_3 + N_1 P_2 + N_2 P_1 = 2000 \times 0.25 + 200 \times 0.15 + 320 \times 0.1$	562
4	$N_4 = N_0 P_4 + N_1 P_3 + N_2 P_2 + N_3 P_1 = 2000 \times 0.3 + 200 \times 0.25 + 320 \times 0.15 + 562 \times 0.1$	754.2
5	$N_5 = N_0 P_5 + N_1 P_4 + N_2 P_3 + N_3 P_2 + N_4 P_1 = 2000 \times 0.2 + 200 \times 0.3 + 320 \times 0.25 + 562 \times 0.15 + 754.2 \times 0.1$	699.72

Computation of Average cost

Month (x)	Cumulative number of component Replace individually by month end	Cost		Total Cost (Tc)	Average Cost = Tc/n
		Individual	Group		
		₹	₹	₹	₹ per month
1	200	600	2000	2600	2600
2	520	1560	2000	3560	1780
3	1082	3246	2000	5246	1748.67*
4	1836.2	5508.6	2000	7508.6	1877.15
5	2535.92	7607.76	2000	9607.76	1921.55

Since the average cost is lowest in 3rd month, the optimal interval i.e. replacement is 3 months. Also the average cost is less than ₹ 1791 of individual replacement, **the group replacement policy is better.**

**(b) Let 'K' be the cost of Individual Replacement**

Month	Average Cost of Group Replacement	Average cost of Individual Replacement	'K' Value* (₹)
1	$(2000 + 200 K)/1$	597 K	5.04
2	$(2000 + 520 K)/2$	597 K	2.97
3	$(2000 + 1082 K)/3$	597 K	2.82
4	$(2000 + 1836.2 K)/4$	597 K	3.62
5	$(2000 + 2535.92 K)/5$	597 K	4.45

* To obtain the value of K use the equation Average cost of Individual Replacement = Average Cost of Group Replacement

If group replacement is anything smaller than 2.82, then Group Replacement would be uneconomical.

(c) Let 'a' be the unit cost of Group Replacement Policy

Month	Average Cost of Group Replacement	Average of Individual Replacement	'a' Value (₹)
1	$(2000 a + 600)/1$	1791	0.60
2	$(2000 a + 1560)/2$	1791	1.01
3	$(2000 a + 3246)/3$	1791	1.06
4	$(2000 a + 5508.6)/4$	1791	0.83
5	$(2000 a + 7607.76)/5$	1791	0.67

When unit cost is more than ₹ 1.06 then Individual Replacement policy would be better.

Illustration 10.

An electric company which generates and distributes electricity conducted a study on the life of poles. The repatriate life data are given in the following table:

Life data of electric poles

Year after installation:	1	2	3	4	5	6	7	8	9	10
Percentage poles failing:	1	2	3	5	7	12	20	30	16	4

- If the company now installs 5,000 poles and follows a policy of replacing poles only when they fail, how many poles are expected to be replaced each year during the next ten years?

To simplify the computation assume that failures occur and replacements are made only at the end of a year.

- If the cost of replacing individually is ₹ 160 per pole and if we have a common group replacement policy it costs ₹ 80 per pole, find out the optimal period for group replacement.

Answer:

Chart showing Optimal Replacement Period

Average life of the pole - $1 \times 0.01 + 2 \times 0.02 + 3 \times 0.03 + 4 \times 0.05 + 5 \times 0.07 + 6 \times 0.12 + 7 \times 0.20 + 8 \times 0.3 + 9 \times 0.16 + 10 \times 0.04 = 7.05$ years.

No. of poles to be replaced every year = $\frac{5000}{7.05} = 709$

Average yearly cost on individual replacement = $709 \times ₹160 = ₹1,13,440$.

Group Replacement: Initial Cost = $5,000 \times ₹80 = ₹4,00,000$.

Year	No. of poles to be replaced	Yearly cost of individual replacement @ ₹ 160/pole (₹)	Cumulative cost of individual replacement (₹)	Total cost of individual replacement as well as group replacement (₹)	Average Annual Cost = $\frac{\text{Total Cost}}{\text{Year}}$ (₹)
1	$5,000 \times 0.01 = 50$	8,000	8,000	4,08,000	4,08,000
2	$5,000 \times 0.02 + 50 \times 0.01 = 101$	16,160	24,160	4,24,160	2,12,080
3	$5,000 \times 0.03 + 50 \times 0.02 + 101 \times 0.01 = 152$	24,320	48,480	4,48,480	1,49,493
4	$5,000 \times 0.05 + 50 \times 0.03 + 101 \times 0.02 + 152 \times 0.01 = 256$	40,960	89,440	4,89,440	1,22,360
5	$5,000 \times 0.07 + 50 \times 0.05 + 101 \times 0.03 + 152 \times 0.02 + 256 \times 0.01 = 362$	57,920	1,47,360	5,47,360	1,09,472
6	$5,000 \times 1.2 + 50 \times 0.07 + 101 \times 0.05 + 152 \times 0.03 + 256 \times 0.02 + 362 \times 0.01 = 6023$	9,63,680	11,11,040	15,11,040	2,51,840

Optimal replacement at the end of the 5th year.

Illustration 11.

Product A has a Mean Time Between Failures (MTBF) of 30 hours and has a Mean Time To Repairs (MTTR) of 5 hours. Product B has a MTBF of 40 hours and has a MTTR of 2 hours.

- Which product has the higher reliability?
- Which product has greater maintainability?
- Which product has greater availability?

Answer:

- Product B, with higher MTBF (i.e. 40 hours) than Product A (i.e. 30 hours), is more reliable since it has lesser chance of failure during servicing.
- By MTTR we mean the time taken to repair a machine and put it into operation. Thus Product B, with lesser MTTR (i.e., 2 hours) than Product A (i.e., 5 hours), has greater maintainability.
- Availability of a machine/product = $\frac{\text{MTBF}}{\text{MTBF} + \text{MTTR}}$

Therefore, Availability of Product A = $30 / (30+5) = 30/35 = 85.714\%$

Availability of Product B = $40 / (40+2) = 40/42 = 95.238\%$

Hence, Product B has more availability.

**Illustration 12.**

Maharashtra Trucking Company (MTC) has a fleet of 50 trucks. The past data on the breakdown of the trucks show the following probability distribution (for a new truck as well as for one which has been repaired after a breakdown).

Months after Maintenance	Probability of Breakdown
1	0.10
2	0.20
3	0.30
4	0.40

Each breakdown costs ₹ 3,000 on an average; which includes cost of time lost and cost of materials and manpower.

The manager of MTC knows the importance of preventive maintenance. He estimates the costs of the preventive maintenance to be ₹ 500 per such preventive action. What should be the appropriate maintenance policy in terms of the mix of preventive and breakdown maintenance

Answer:

First, let us compute the cost of a totally breakdown maintenance policy.

The expected number of months between failures

$$= 0.1 (1) + 0.2 (2) + 0.3 (3) + 0.4 (4) = 3.0$$

Cost per month of totally breakdown maintenance policy

$$\begin{aligned} &= \frac{(\text{No. of trucks}) (\text{Cost per breakdown})}{(\text{Expected number of months between failure})} \\ &= \frac{(50) (\text{₹}3000)}{(3.0)} = \text{₹ } 50,000 \end{aligned}$$

Now let us compute the costs of different periodicities of preventive maintenance.

(i) Preventive maintenance (PM) period one month

No. of breakdowns within the period of one month:

$$B_1 = (50) \times (0.1) = 5$$

$$\text{Cost of breakdown} = 5 \times \text{₹ } 3000 = \text{₹ } 15,000$$

$$\text{Cost of preventive maintenance} = \text{₹ } 500 \times 5 = \underline{\text{₹ } 25,000}$$

$$\text{Total Cost during the PM period} = \text{₹ } 40,000$$

Therefore, cost per month for this policy is

$$= 40,000 \div 1 = \text{₹ } 40,000$$

(ii) Preventive maintenance (PM) period two months

No. of breakdowns within 2 months:

$$B_2 = (50) \times (0.1 + 0.2) + (50) \times (0.1) \times (0.1) = 15.5$$



$$\text{Cost of breakdown} = (15.5) \times ₹ 3000 = ₹ 46,500$$

$$\text{Cost of prev. maintenance} = ₹ 500 \times 50 = ₹ 25,000$$

$$\text{Total cost during the PM period} = ₹ 71,500$$

Therefore, cost per month for this policy:

$$₹ 71,500 \div 2 \text{ months} = ₹ 35,750$$

(iii) Preventive maintenance period 3 months

No. of breakdowns within 3 months:

$$\begin{aligned} B_3 &= (50) \times (0.1 + 0.2 + 0.3) + (50 \times 0.1) (0.1 + 0.2) + (50 \times 0.1 \times 0.1) (0.1) \\ &= 30 + 1.5 + 0.05 = 31.55 \end{aligned}$$

$$\text{Cost of breakdown} = 31.55 \times ₹ 3000 = ₹ 94,650$$

$$\text{Cost of preventive maintenance} = 50 \times ₹ 500 = ₹ 25,000$$

$$\text{Total} = ₹ 1,19,650$$

Therefore, cost per month for this policy

$$= ₹ 1,19,650 \div 3 \text{ months} = ₹ 39,883.33$$

(iv) Preventive maintenance period 4 months

No. of breakdowns within 4 months

$$\begin{aligned} B_4 &= [(50) \times (1.0)] + [(50) \times (0.1) \times (0.1 + 0.2 + 0.3) + (50 \times 0.1 \times 0.1) \times (0.1 + 0.2) + (50 \times 0.1 \times 0.1 \times 0.1) \times (0.1) \\ &\quad + (50 \times 0.1 \times 0.2) \times (0.1)] + [(50 \times 0.2) \times (0.1 + 0.2) + (50 \times 0.2 \times 0.1) \times (0.1)] + [(50 \times 0.3 \times (0.1))] \\ &= 57.855 \end{aligned}$$

$$\text{Cost of breakdown} = (57.855) \times (₹ 3,000) = ₹ 1,73,565$$

$$\text{Cost of preventive maintenance} = 50 \times ₹ 500 = ₹ 25,000$$

$$\text{Total} = ₹ 1,98,565$$

Therefore, cost per month for this policy is ₹ 1,98,565 ÷ 4 months = ₹ 49,641.25

Comparing the costs per month of different policies, we see that the policy of preventive maintenance every two months is the most economic policy.



OBJECTIVE TYPE QUESTIONS & ANSWERS

Choosing of Correct Answers:

1. Number of product varieties that can be manufactured in Job production is:

(a) Limited to one or two, (b) Large varieties of products, (c) One only, (d) None of the above.

Ans. (b)

2. Number of product varieties that can be manufactured in Mass production is:

(a) One only, (b) Two only, (c) Few varieties in large volumes, (d) Large varieties in small volumes.

Ans. (c)

3. In general number of product varieties that can be manufactured in Flow production is:

(a) One only, (b) Ten to twenty varieties, (c) Large varieties, (d) Five only.

Ans. (a)

4. Generally the size of the order for production in Job production is:

(a) Small, (b) Large, (c) Medium, (d) Very large.

Ans. (a)

5. Generally in continuous production the production is carried out to:

(a) Customer's order, (b) Government orders only, (c) For stock and supply, (d) Few rich customers.

Ans. (c)

6. Inventory cost per product in intermittent production is: (a) Higher, (b) Lowest, (c) Medium, (d) Abnormal.

Ans. (a)

7. The material handling cost per unit of product in Continuous production is:

(a) Highest compared to other systems, (b) Lower than other systems, (c) Negligible, (d) Cannot say.

Ans. (b)

8. Routing and Scheduling becomes relatively complicated in

(a) Job production, (b) Batch production, (c) Flow production, (d) Mass production.

Ans. (b)

9. The starting point of Production cycle is:

(a) Product design, (b) Production Planning, (c) Routing, (d) Market research.

Ans. (d)

10. Variety reduction is generally known as:

(a) Less varieties, (b) Simplification, (c) Reduced varieties, (d) None of the above.

Ans. (b)

11. Preferred numbers are used to:

(a) To determine the number of varieties that are to be manufactured, (b) To test the design of the product, (c) To ascertain the quality level of the product, (d) To evaluate the production cost.

Ans. (a)



12. The act of assessing the future and make provisions for it is known as (a) Planning, (b) Forecasting, (c) Assessment, (d) Scheduling.

Ans. (b)

13. For a marketing manager, the sales forecast is:

(a) Estimate of the amount of unit sales or a specified future period, (b) Arranging the sales men to different segments of the market, (c) To distribute the goods through transport to satisfy the market demand, (d) To plan the sales methods.

Ans. (a)

14. The time horizon selected for forecasting depends on:

(a) The salability of the product, (b) The selling capacity of Salesman, (c) Purpose for which forecast is made, (d) Time required for production cycle.

Ans. (c)

15. For production planning:

(a) Short term forecasting is useful, (b) Medium term forecasting is useful, (c) Long term forecasting is useful, (d) Forecasting is not useful.

Ans. (a)

16. In general, medium range forecasting period will be approximately:

(a) 5 to 10 Years, (b) 2 to 3 days, (c) 3 to 6 months, (d) 10 to 20 years.

Ans. (c)

17. The range of Long range forecasting period may be approximately: (a) 1 to 2 weeks, (b) 2 to 3 months, (c) 1 year, (d) above 5 years.

Ans. (d)

18. To plan for future man power requirement:

(a) Short term forecasting is used, (b) Long range forecasting is used, (c) Medium range forecasting is used, (d) There is no need to use forecasting, as future is uncertain.

Ans. (b)

19. Long range forecasting is useful in:

(a) Plan for Research and Development, (b) To Schedule jobs in Job production, (c) In purchasing the material to meet the present production demand, (d) To assess manpower required in the coming month.

Ans. (a)

20. Medium range forecasting is useful in:

(a) To assess the loading capacity of the machine, (b) To purchase a materials for next month, (c) To plan for-capacity adjustments, (d) To decide whether to receive production orders or not.

Ans. (c)

21. To decide work load for men and machines:

(a) Medium range forecasting is used, (b) Short term forecasting is used, (c) Long range forecasting is used, (d) A combination of long range and medium range forecasting is used.

Ans. (b)



22. Important factor in forecasting production is:

- (a) Environmental changes, (b) Available capacity of machines, (c) Disposable income of the consumer, (d) Changes in the preference of the consumer.

Ans. (b)

23. Application of technology or process to the raw material to add use value is known as:

- (a) Product, (b) Production, (c) Application of technology, (d) Combination of technology and process.

Ans. (b)

24. In Production by disintegration the material undergoes:

- (a) Change in economic value only, (b) Change in physical and chemical characteristics, (c) Change in technology only, (d) None of the above.

Ans. (b)

25. In Production by service, the product undergoes the changes in:

- (a) Shape and size of the surface, (b) Shape of the surface only, (c) Size of the surface only, (d) Chemical and Mechanical properties.

Ans. (d)

26. Use of any process or procedure designed to transform a set of input elements into a set of output elements is known as:

- (a) Transformation process, (b) Transformation of input to output, (c) Production, (d) Technology change.

Ans. (c)

27. Conversion of inputs into outputs is known as:

- (a) Application of technology, (b) Operations management, (c) Manufacturing products, (d) Product.

Ans. (b)

28. The desired objective of Production and Operations Management is:

- (a) Use cheap machinery to produce, (b) To train unskilled workers to manufacture goods perfectly, (c) Optimal utilisation of available resources, (d) To earn good profits.

Ans. (c)

29. The scope of Production Planning and Control is:

- (a) Limited to Production of products only, (b) Limited to production of services only, (c) Limited to production of services and products only, (d) Unlimited, can be applied to any type of activity.

Ans. (d)

30. Manufacturing system often produces:

- (a) Standardised products, (b) Standardised products in large volumes, (c) Substandard products in large volumes, (d) Products and services in limited volume.

Ans. (a)

31. The difference between product system and project system is:

- (a) Project system the equipment and machinery are fixed where as in product system they are movable,
- (b) In Product system the machinery and equipment are fixed and in project system they are not fixed,
- (c) Project system produces only standardized products and product system produces only unstandardised products,
- (d) Products cannot be stocked whereas projects can be stocked.

Ans. (b)



32. Most important benefit to the consumer from efficient production system is:
(a) He can save money, (b) He will have product of his choice easily available, (c) He gets increased use value in the product, (d) He can get the product on credit.

Ans. (c)

33. Two important functions that are to be done by Production department are: (a) Forecasting, (b) Costing, (c) Scheduling and loading, (d) Inspecting.

Ans. (c)

34. Fixing the flow lines of materials in production is known as: (a) Scheduling, (b) Loading, (c) Planning, (d) Routing.

Ans. (d)

35. The act of releasing the production documents to the production department is known as: (a) Planning, (b) Routing, (c) Dispatching, (d) Releasing.

Ans. (c)

36. The activity of specifying when to start the job and when to end the job is known as:

(a) Planning, (b) Scheduling, (c) Timing, (d) Follow-up.

Ans. (b)

37. In an organisation the production planning and control department comes under:

(a) Planning department, (b) Manufacturing department, (c) Personal department, (d) R & D department.

Ans. (b)

38. In Job production system, we need:

(a) More unskilled labours, (b) Skilled labours, (c) Semi-skilled labours, (d) Old people.

Ans. (b)

39. In Continuous manufacturing system, we need:

(a) General purpose machines and Skilled labours, (b) Special machine tools and highly skilled labours, (c) Semi automatic machines and unskilled labours, (d) General purpose machines and unskilled labours.

Ans. (b)

40. Most suitable layout for Job production is:

(a) Line layout, (b) Matrix layout, (c) Process layout, (d) Product layout.

Ans. (c)

41. Most suitable layout for Continuous production is:

(a) Line layout, (b) Process Layout, (c) Group technology, (d) Matrix layout.

Ans. (a)

42. One of the product examples for Line layout is:

(a) Repair workshop, (b) Welding shop, (c) Engineering College, (d) Cement.

Ans. (d)

43. The act of going round the production shop to note down the progress of work and feedback the information is known as:

(a) Follow up, (b) Dispatching, (c) Routing, (d) Trip card.

Ans. (a)



44. Line of Best fit is another name given to:

- (a) Method of Least Squares, (b) Moving average method, (c) Semi average method, (d) Trend line method.

Ans. (a)

45. One of the important basic objectives of Inventory management is:

- (a) To calculate EOQ for all materials in the organisation, (b) To go in person to the market and purchase the materials, (c) To employ the available capital efficiently so as to yield maximum results, (d) Once materials are issued to the departments, personally check how they are used.

Ans. (c)

46. The best way of improving the productivity of capital is:

- (a) Purchase automatic machines, (b) Effective Labour control, (c) To use good financial management, (d) Productivity of capital is to be increased through effective materials management.

Ans. (d)

47. MRP stands for:

- (a) Material Requirement Planning, (b) Material Reordering Planning, (c) Material Requisition Procedure, (d) Material Recording Procedure.

Ans. (a)

48. JIT stands for:

- (a) Just in time purchase, (b) Just in time production, (c) Just in time use of materials, (d) Just in time order the material.

Ans. (b)

49. The cycle time, selected in balancing a line must be:

- (a) Must be greater than the smallest time element given in the problem, (b) Must be less than the highest time element given in the problem, (c) Must be slightly greater than the highest time element given in the problem, (d) Left to the choice of the problem solver.

Ans. (c)

50. The lead-time is the time:

- (a) To placeholders for materials, (b) Time of receiving materials, (c) Time between receipt of material and using materials, (d) Time between placing the order and receiving the materials.

Ans. (d)

51. Production planning deals with:

- (a) What production facilities is required and how these facilities should be laid out in space available, (b) What to produce and when to produce and where to sell, (c) What should be the demand for the product in future? (d) What is the life of the product?

Ans. (a)

52. The first stage in production planning is:

- (a) Process Planning, (b) Factory Planning, (c) Operation Planning, (d) Layout planning.

Ans. (b)

53. In Process Planning we plan:

- (a) Different machines required, (b) Different operations required, (c) We plan the flow of material in each department, (d) We design the product.

Ans. (c)



54. In Operation Planning:

- (a) The planner plans each operation to be done at work centers and the sequence of operations, (b) Decide the tools to be used to perform the operations, (c) Decide the machine to be used to perform the operation, (d) Decide the materials to be used to produce the product.

Ans. (a)

55. Before thinking of routing, the production planner has to:

- (a) Decide the optimal allocation of available resources, (b) To decide what type of labour to be used, (c) To decide how much of material is required, (d) To count how many orders he has on his hand.

Ans. (a)

56. The quantities for which the planner has to prepare production plan are known as:

- (a) Optimal quantity of products, (b) Material planning, (c) Quantity planning, (d) Planning quantity standards.

Ans. (d)

57. The document, which is used to show planning quantity standards and production plan, is known as:

- (a) Planning specifications, (b) Route sheet, (c) Bill of materials, (d) Operation sheet.

Ans. (a)

58. In route sheet or operation layout, one has to show:

- (a) A list of Materials to be used, (b) A list of machine tools to be used, (c) Every work center and the operation to be done at that work center, (d) The cost of product.

Ans. (c)

59. The cycle time in selected in balancing a line must be:

- (a) Must be greater than the smallest time element given in the problem, (b) Must be less than the highest time element given in the problem, (c) Must be slightly greater than the highest time element given in the problem, (d) Left to the choice of the problem solver.

Ans. (c)

60. In solving a problem on LOB, the number of workstations required is given by:

- (a) Cycle time/Total time, (b) Cycle time/Element time, (c) Total time/Element time, (d) Total time/ Cycle time.

Ans. (d)

61. $(\text{Total station time}/\text{Cycle time} \times \text{Number of work stations}) \times 100$ is know as:

- (a) Line Efficiency, (b) Line smoothness, (c) Balance delay of line, (d) Station efficiency.

Ans. (a)

62. Final stage of production planning, where production activities are coordinated and projected on a time scale is known as:

- (a) Scheduling, (b) Loading, (c) Expediting, (d) Routing.

Ans. (a)

63. Scheduling shows:

- (a) Total cost of production, (b) Total material cost, (c) Which resource should do which job and when, (d) The flow line of materials.

Ans. (c)



64. Scheduling deals with:

(a) Number of jobs to be done on a machine, (b) Number of machine tools used to do a job, (c) Different materials used in the product, (d) Fixing up starting and finishing times of each operation in doing a job.

Ans. (d)

65. The study of relationship between the load on hand and capacity of the work centers is known as:
(a) Scheduling, (b) Loading, (c) Routing, (d) Controlling.

Ans. (b)

66. One of the aims of loading is:

(a) To finish the job as early as possible, (b) To minimise the material utilisation, (c) To improve the quality of product, (d) To keep operator idle time, material waiting time and ancillary machine time at minimum.

Ans. (d)

67. One of the principles of Scheduling is:

(a) Principle of optimal product design, (b) Principle of selection of best material, (c) Principle of optimal operation sequence, (d) Principle of optimal cost.

Ans. (c)

68. The method used in scheduling a project is:

(a) A schedule of breakdown of orders, (b) Outline Master Programme, (c) PERT & CPM, (d) Schedule for large and integrated work.

Ans. (c)

69. Production planning in the intermediate range of time is termed as:

(a) Production planning, (b) Long range production planning, (c) Scheduling, (d) Aggregate planning.

Ans. (d)

70. One of the requirements of Aggregate Planning is:

(a) Both output and sales should be expressed in a logical overall unit of measuring, (b) Appropriate time period, (c) List of all resources available, (d) List of operations required.

Ans. (a)

71. In aggregate planning, one of the methods in modification of demand is:

(a) Differential Pricing, (b) Lay off of employees, (c) Over time working, (d) Sub contracting.

Ans. (a)

72. In aggregate planning one of the methods used to modification of supply is:

(a) Advertising and sales promotion, (b) Development of complimentary products, (c) Backlogging, (d) Hiring and lay off of employees depending on the situation.

Ans. (d)

73. The first stage of Production control is:

(a) Dispatching, (b) Scheduling, (c) Routing, (d) Triggering of production operations and observing the progress and record the deviation.

Ans. (d)



74. The act of releasing the production documents to production department is known as:

- (a) Routing, (b) Scheduling, (c) Expediting, (d) Dispatching.

Ans. (d)

75. One of the important production documents is:

- (a) Design sheet of the product, (b) List of materials, (c) Route card, (d) Control chart.

Ans. (c)

76. One of the important charts used in Programme control is:

- (a) Material chart, (b) Gantt chart, (c) Route chart, (d) Inspection chart.

Ans. (b)

77. The way in which we can assess the efficiency of the production plant is by:

- (a) Efficient dispatching, (b) By manufacturing a good product, (c) By comparing the actual performance with targets specified in the specified programme, (d) By efficient production planning.

Ans. (c)

78. Production control concerned with:

- (a) Passive assessment of plant performance, (b) Strict control on labours, (c) Good materials management, (d) Good product design.

Ans. (a)

79. When work centers are used in optimal sequence to do the jobs, we can:

- (a) Minimise the set up time, (b) Minimise operation time, (c) Minimise the break down of machines, (d) Minimise the utility of facility.

Ans. (a)

80. The act of going round the production shop to note down the progress of work and feedback the information is known as:

- (a) Follow up, (b) Dispatching, (c) Routing, (d) Trip card.

Ans. (a)

81. One of the activities of expediting is:

- (a) To file the orders in sequence, (b) To decide the sequence of operation, (c) To record the actual production against the scheduled production, (d) To examine the tools used in production.

Ans. (c)

82. 'Z' chart is a chart used in:

- (a) Programme control, (b) Job control, (c) Cost control, (d) Quality control.

Ans. (a)

83. Z-chart can be used to show:

- (a) Process used in production, (b) Quality level of the product, (c) Both the plan and the performance, and deviation from the plan, (d) To show cost structure of the product.

Ans. (c)

84. Computers are used in Production control in this area:

- (a) Follow-up activity, (b) To control labour, (c) To disseminate information, (d) Loading, Scheduling and Assignment works.

Ans. (d)

**Other Types - Question & Answer:**

1. Match the product in Column I with the production centre/equipment/plant in Column II.

I	II
A. Furniture	i. Assembly line
B. Hydro-electricity	ii. Refinery
C. Television set	iii. Carpentry
D. Cement	iv. Turbo-Alternator
E. Aviation Fuel	v. Rotary Kiln
F. Tools	vi. Machine shop

Answer:

Matching:

I	II
A. Furniture	iii. Carpentry
B. Hydro-electricity	iv. Turbo-Alternator
C. Television set	i. Assembly line
D. Cement	v. Rotary Kiln
E. Aviation Fuel	ii. Refinery
F. Tools	vi. Machine shop

2. Match the terms shown under 'X' with their relevant terms; shown under 'Y'.

X	Y
a. Ranking Method	1. Method Study
b. Motion Economy	2. Plant Layout
c. Work Sampling	3. Job Evaluation
d. Normal Curve	4. Inventory Control
e. Use of Templates	5. Statistical Quality Control
f. Crashing	6. Network Analysis
g. Replacement	7. Value Analysis
h. Brainstorming	8. Work Measurement
i. Stock Level	9. Maintenance

Answer:

Matching:

X	Y
a. Ranking Method	3. Job Evaluation
b. Motion Economy	1. Method Study
c. Work Sampling	8. Work Measurement
d. Normal Curve	5. Statistical Quality Control
e. Use of Templates	2. Plant Layout
f. Crashing	6. Net work Analysis
g. Replacement	9. Maintenance
h. Brainstorming	7. Value Analysis
i. Stock Level	4. Inventory Control



3. Match the products in Column I with the production centers in Column II.

I	II
(A) Electricity	(a) Blast Furnace
(B) Petrol	(b) Generator
(C) Iron	(c) Refinery
(D) Cloth	(d) Assembly Line
(E) Car	(e) Smithy
(F) Cotton Yarn	(f) Spinning Mill
(G) Forgings	(g) Power Loom

Answer:

Matching:

I	II
(A) Electricity	(b) Generator
(B) Petrol	(c) Refinery
(C) Iron	(a) Blast Furnace
(D) Cloth	(g) Power Loom
(E) Car	(d) Assembly Line
(F) Cotton Yarn	(f) Spinning Mill
(J) Forgings	(e) Smithy

4. State whether the following statements are TRUE or FALSE.

- (i) Method Study should precede Work Measurement.
- (ii) Merit Rating is used to determine the cost of a product.
- (iii) Production planning is an essential function in a factory.
- (iv) Training boosts employee morale.
- (v) A good Materials Handling system always consists of conveyors.
- (vi) Increased productivity leads to cost reduction.
- (vii) Project costs increase as the duration of the project increases.
- (viii) When demand does not exist in the market, we should start Production Incentives.
- (ix) A work stoppage generally reduces the cost of production.
- (x) No handling is the best handling.
- (xi) It is desirable to conduct work measurement after Method study.
- (xii) Job Evaluation is used to measure absolute job worth.
- (xiii) Incentive scheme is introduced by Management with a view to reduce direct labour cost.
- (xiv) The increase in productivity can be attributed to the application of Industrial Engineering/Techniques, particularly the work study.
- (xv) Operation process chart incorporates all five symbols.
- (xvi) Multiple Activity chart deals with layout problems.



- (xvii) Standard performance is the natural rate of working of an average operator when he works under proper supervision but without any financial motivation.
- (xviii) Allowances for non-availability of materials power failure and breakdown of machines are provided for in the standard time for an operation/job.
- (xix) In carrying-out Job Evaluation studies, point system is the best method.
- (xx) It is justified to consider the effect of working condition both in Work Measurement and Job-Evaluation.
- (xxi) Increase in productivity leads to retrenchment of work force.
- (xxii) In view of rapid technological advancement we would not concentrate on labour productivity.
- (xxiii) Piece wage system is a substitute for proper supervision.
- (xxiv) Personnel Manager has nothing to do with productivity. It is the job of Technical Personnel.
- (xxv) Ranking is one of the Job Evaluation Techniques.
- (xxvi) Results available from work sampling study is not 100% accurate.
- (xxvii) Since breakdown of Plant and machineries is a random phenomenon, it is impossible to do any work measurement in Maintenance Area.
- (xxviii) Job Evaluation does not help in performance Rating i. There is no difference between Method study and Value Engineering.
- (xxix) Two-handed process chart is the most suitable Recording Technique in Electronics Assembly Industry.

Answer:

(i) True (ii) False (iii) True (iv) True (v) False (vi) True (vii) True (viii) False (ix) False (x) True (xi) True (xii) False (xiii) False (xiv) True (xv) True (xvi) False (xvii) False (xviii) False (xix) True (xx) True (xxi) False (xxii) False (xxiii) False (xxiv) False (xxv) True (xxvi) True (xxvii) False (xxviii) False (xxix) False.

5. Answer the following Queries:

- (i) Do standard Times allow for relaxation of the Operators?
- (ii) Is a lift same as an elevator?
- (iii) Is the use of metric system of weights and measures compulsory in India?
- (iv) Can the shaping machine be considered a versatile machine tool?
- (v) Does the Factories Act in India allow the employment of women in all industries?
- (vi) Is Break-even analysis a management tool?
- (vii) Is Activity Sampling a technique of Job Evaluation?

Answer:

- (i) Yes (v) No
- (ii) Yes (vi) Yes
- (iii) Yes (vii) No
- (iv) No



6. Given below are two lists—list 'A' containing 11 abbreviations and list 'B' containing various functional areas associated with production management. Expand the abbreviations and match them with the corresponding functional areas.

List 'A'	List 'B'
LP	Capacity planning
PERT	Quality control
MTM	Project funding
VA	Project viability checking
SRAC	Inventory management
MRP	Product design
CBA	Cost control
CAD	Product mix determination
IFCI	Project planning
AOQ	Work measurement

Answer:

List 'A'	Expansion	Matching with List 'B'
LP	Linear Programming	Product mix determination
PERT	Programme Evaluation and Review Technique	Project planning
MTM	Methods Time measurement	Work measurement
VA	Value Analysis	Cost control
SRAC	Short Run Average Cost	Capacity planning
MRP	Materials Requirement Planning	Inventory management
CBA	Cost Benefit Analysis	Project viability checking
CAD	Computer Aided Design	Product design
IFCI	Industrial Finance Corporation of India	Project funding
AOQ	Average outgoing Quality	Quality control

7. Choose the word or phrase which would be appropriate to fill up the blanks in each statement:
- Statistical analysis is used to determine the optimum policy of _____ maintenance.
 - Watch and ward personnel are responsible for _____ aspects in a factory.
 - General purpose machine are less prone to _____ .
 - The pattern shop in a factory should ideally be near the _____ .
 - Factor Comparison is a method of _____ .
 - Taylor originated the idea of _____ relationships in an organisation.
 - _____ cannot be delegated.
 - Ergonomics is another name for _____ .
 - Gantt chart is used for _____ control.

**Answer:**

- (i) preventive
- (ii) security
- (iii) obsolescence
- (iv) foundry
- (v) job evaluation
- (vi) functional
- (vii) responsibility
- (viii) human engineering
- (ix) production

8. Match the terms in Column I with the relevant terms in Column II.

Column I	Column II
(A) Inventory Control	(i) Turbo-Alternator
(B) Network Analysis	(ii) Crashing
(C) Aviation Fuel	(iii) Value Analysis
(D) Hydro-electricity	(iv) Stock Level
(E) Improvement in productivity	(v) Refinery

Answer:

(A) – (iv); (B) – (ii); (C) – (v); (D) – (i); (E) – (iii).

9. For each part below, choose the most appropriate answer out of the four options given against each part:

- (i) The following establishes time sequence of operations:
(A) Routing, (B) Sequencing, (C) Scheduling, (D) Dispatching.
- (ii) Arrangement of machines depending on sequence of operations happens in:
(A) Process Layout, (B) Product Layout, (C) Hybrid Layout, (D) Group Technology Layout.
- (iii) Linear Programming is a technique used for determining:
(A) Production Programme, (B) Plant Layout, (C) Product Mix, (D) Manufacturing sequence.

Answer:

(i) (C) Scheduling, (ii) (B) Product Layout, (iii) (C) Product Mix.

10. For each part below, choose the most appropriate answer out of the four options given against each part.

- (i) Issuing necessary orders, and taking necessary steps to ensure that the time targets set in the schedules are effectively achieved is known as:
A. Routing, B. Dispatching, C. Scheduling, D. Inspection.
- (iii) Preventive maintenance is useful in reducing: A. Inspection Cost, B. Shutdown Cost, C. Cost of premature replacement, D. Set-up cost of machine

**Answer:**

- (i) (B) **Dispatching** - Dispatching is one of the important production control functions.
- (i) (B) **Shutdown Cost** - Preventive maintenance tries to minimize the problems of breakdown maintenance. It locates weak parts in all equipments, provide them regular inspection and minor repairs thereby reducing the breakdowns.
11. Examine each statement and indicate whether it is 'True' or 'False' :
- (i) Project cost increases as the duration of the project increases.
- (ii) With increase in lot size the setup cost per unit decreases, whereas the inventory carrying cost increases.
- (iii) If the total float value is zero, it means the resources are just sufficient to complete the activity without delay.

Answer:

- (i) Project cost increases as the duration of the project increases. – True
One of the feature of project is, it has defined start and end dates. If project's duration time increases, the cost also increases.
- (ii) With increase in lot size the setup cost per unit decreases, whereas the inventory carrying cost increases. – True.
Because, the size and carrying cost are directly related. If size increases the carrying cost also increased.
- (iii) If the total float value is zero, it means the resources are just sufficient to complete the activity without any delay. – True
If the total float value is negative, it denotes that the resources are not adequate to finish in time. Again, if total float value is Positive, it denotes that resources are in excess or the resources should be reallocated to avoid the delay, otherwise the activity will be delayed by so much of time. If total float value is zero, it means the resources are just sufficient to complete the activity without any delay.
12. For each part below, choose the most appropriate answer out of the four options given against each part:
- (i) One of the important charts used in Programme control is:
(A) Material chart, (B) Gantt chart, (C) Route chart, (D) Inspection chart.
- (ii) Generally the size of the order for production in Job production is:
(A) Small, (B) Large, (C) Medium, (D) Very large.

Answer:

- (i) (B) Gantt Chart,
- (ii) (A) Small.

13. Put an appropriate word in blank position :

- (i) _____ focuses on such areas as inventory goals and wages budgets.
- (ii) IBFS is optimal and unique when all numbers in the _____ are non-negative.
- (iii) The investment on machines in a straight line layout is _____ than the investment on machines in a functional layout.

Answer:

- (i) Short-range planning
- (ii) Net Evaluation Table
- (iii) Higher



14. Examine each statement and indicate whether it is 'True' or 'False'.
- (i) A special purpose Machine Tool performs only a limited number of specialised operations with great speed and precision.
 - (ii) Strikes and lock-out are controllable factors affecting Capacity Planning.
 - (iii) Incentives are substitute for lower wages.
 - (iv) Linear Programming does not consider uncertainties
 - (v) Depending on the need, the maintenance activity may be centralized or decentralized.

Answer:

- (i) TRUE
- (ii) FALSE
- (iii) FALSE
- (iv) TRUE
- (v) TRUE

15. For each part below, choose the most appropriate answer out of the four options given against each part :
- (i) One of the product examples for Line Layout is :
(A) Repair Workshop, (B) Welding shop, (C) Engineering College, (D) Cement.
 - (ii) The card which is prepared by the dispatching department to book the labour involved in each operation is :
(A) Labour card, (B) Wage card, (C) Credit card, (D) Job card.
 - (iii) Cost reduction can be achieved through :
(A) Work sampling, (B) Value analysis, (C) Quality assurance, (D) Supply chain management.
 - (iv) Addition of value to raw materials through application of technology is :
(A) Product, (B) Production, (C) Advancement, (D) Transformation.

Answer:

- (i) (D) Cement — Line layout is suitable in plants manufacturing standardised products on mass scale like cement, paper, chemical etc.
- (ii) (D) Job card — A job card gives detail of job to be performed in a production facility.
- (iv) (B) Value analysis — It is systematic analysis that identifies and selects best alternatives for designs, materials, processes & systems.
- (v) (B) Production — It is the act of manufacturing goods.

16. Put an appropriate word or two in blank position:

- (a) To evaluate the work done by preventive maintenance, _____ is derived at from the total time of stoppage of the machine for scheduled and unscheduled maintenance work.
- (b) In linear programming, the word 'linear' establishes certain relationships among different _____ .

Answer:

- (a) Down time
- (b) Variables



17. Examine each statement and indicate whether it is True or False:

- (i) In general, long-range forecasting is more useful in production planning.
- (ii) A work stoppage generally reduces the cost of production.

Answer:

- (i) In general, long-range forecasting is more useful in production planning — **False**
- (ii) A work stoppage generally reduces the cost of production.

Reason: Work stoppage does not reduce the cost of production — **False**

18. Put an appropriate word or two in blank position.

- (i)is the interval between placing an order for a particular item and its actual receipt.
- (ii) Product is a combination of potential utilities for a.....
- (iii) A jig contains a device for guiding the.....

Answer:

- (i) Lead time.
- (ii) Consumer.
- (iii) Tools.

19. Examine each statement and indicate whether it is 'True' or 'False':

- (i) There is a limit beyond which labour productivity cannot be improved.
- (ii) When demand does not exist in the market, we should start Production Incentives.
- (iii) Breakdown maintenance doesn't require use of standby machines.

Answer:

- (i) TRUE
- (ii) FALSE
- (iii) FALSE

20. Put an appropriate word in blank position:

- (i) Machines are purchased or replaced to —— the productive capacity.
- (iii) —— can be determined using the Northwest Corner Rule.
- (iv) A —— is an appliance which holds the work when it is machined.

Answer:

- (i) Increase
- (ii) IBFS
- (iii) Fixture

21. Choose the most correct alternative:

- (i) $(\text{Total station time/cycle time} \times \text{Number of work stations}) \times 100$ is known as
 - (A) Line efficiency
 - (B) Line smoothness
 - (C) Balance delay of line
 - (D) Station efficiency



- (ii) The most powerful and popular method for solving linear programming problem is
- (A) Simplex method
 - (B) Graphical method
 - (C) Transportation method
 - (D) Assignment method
- (iii) Most suitable layout for continuous production is
- (A) Line layout
 - (B) Process layout
 - (C) Group technology
 - (D) Matrix layout

Answer:

- (i) (A) Line efficiency
(ii) (A) Simplex method
(iii) (A) Line layout

22. Put an appropriate word in blank position:

- (i) _____ systems replace human beings to read data from products and documents and interpret the data.
(ii) The user's expectation method of _____ provides a subjective feel of the market.
(iii) _____ control is typically found wherever a particular bottleneck machine exist in the process of manufacturing.
(iv) General purpose machines are less prone to _____.

Answer:

- (i) Barcode
(ii) Sales forecasting
(iii) Load
(iv) Obsolescence

- 23.** (i) Activity Sampling is not a technique of Job Evaluation.
(ii) A good plant layout is one of the factors in effective utilization of labour.

Answer:

- (i) True
(ii) True



Section : B
Strategic Management
(Syllabus - 2016)





Study Note - 8

STRATEGIC MANAGEMENT INTRODUCTION



This Study Note includes

8.1 Vision, Mission and Objective

8.1 VISION, MISSION AND OBJECTIVE

STRATEGY:

Strategy is all about integrating organizational activities and utilizing and allocating the scarce resources within the organizational environment so as to meet the present objectives. While planning a strategy it is essential to consider that decisions are not taken in a vacuum and that any act taken by a firm is likely to be met by a reaction from those affected, competitors, customers, employees or suppliers.

Strategy can also be defined as knowledge of the goals, the uncertainty of events and the need to take into consideration the likely or actual behavior of others. Strategy is the outline of decisions in an organization that shows its objectives and goals, reduces the key policies, and plans for achieving these goals, and defines the business the company is to carry on, the type of economic and human organization it wants to be, and the contribution it plans to make to its shareholders, customers and society at large.

Strategy may be defined as the **direction** and **scope** of a organisation over the **long term**, which achieves **advantage** for the organisation through the configuration of **resources** within a changing **environment** and to fulfill **stakeholder** expectations.

The definition of strategy encompasses a comprehensive master approach that states how the corporation will achieve its mission and objectives. It maximizes competitive advantage and minimizes competitive disadvantage.

Features of Strategy:

- (i) Strategy is important to foresight, the uncertain events of firms/industries .
- (ii) Strategy deals with long term developments rather than routine operations. For example innovations or new products, new methods of productions, or new markets to be developed in future.
- (iii) Strategy is created to deal behavior of customers and competitors.
- (iv) Strategy is a well defined roadmap of an organization. It defines the overall mission, vision and direction of an organization. The objective of a strategy is to maximize an organization's strengths and to minimize the strengths of the competitors.

The characteristics of a strategic decision/strategy

- (i) Strategy is likely to be concerned with long-term direction of an organisation.
- (ii) Strategic decisions are normally about trying to achieve some advantage for the organisation over competition.
- (iii) Strategy is likely to be concerned with the scope of the organisation's activities.
- (iv) Strategy can be seen as matching the resources and activities to the environment in which it operates.
- (v) Strategy can be seen as stretching an organisation's resources and competences to create new opportunities or to capitalise on them.
- (vi) Strategies may require major resource changes for an organisation.
- (vii) Strategic decisions likely to affect operational decisions.



(viii) The strategy of an organisation is affected not only by environmental factors and resource availability but also by the values and expectations of those who have power in and around the organisation.

The consequences of the characteristics of strategy

- (i) Strategic Decisions are likely to be **complex in nature**
- (ii) Likely to be made in **situations of uncertainty**
- (iii) Likely to demand an **integrated approach**
- (iv) Manage change **relationships and networks** outside the organisation
- (v) Strategic Decisions will very often involve **change** in organisations

Relationship between strategy and competitive advantage

A company achieves competitive advantage when it provides buyers with superior value compared to rival sellers or offers the same value at a lower cost to the firm. The advantage is sustainable if it persists despite the best efforts of competitors to match or surpass this advantage. A company's strategy is its action plan for outperforming its competitors and achieving superior profitability. In effect, it represents a managerial commitment to an integrated array of considered choices about how to compete. These include choices about:

- (i) How to attract and please customers?
- (ii) How to compete against rivals?
- (iii) How to position the company in the market place?
- (iv) How best to respond to changing economic and market conditions?
- (v) How to capitalize on attractive opportunities to grow the business?
- (vi) How to achieve the company's performance targets?

STRATEGIC MANAGEMENT:

Strategic management is defined by William F. Glueck as "a stream of decisions and actions which leads to the development of an effective strategy or strategies to help achieve objectives."

Strategic management according to Alfred D. Chandler is "determination of the basic long-term goals and objectives of an enterprise and adoption of course of action and allocation of resources necessary to carry out these goals."

Recently Harrison & St. John define Strategic Management as the process through which organisations analyse and learn from their internal and external environments, establish strategic direction, create strategies that are intended to help achieve established goals, and execute these strategies, all in an effort to satisfy key organisational stakeholders.

So Strategic Management is considered as either decision making and planning or a set of activities related to the formulation and implementation of strategies to achieve organisational objectives.

Strategic Management include understanding the *strategic position* of an organisation, *strategic choices* for the future and turning *strategy into action*. The strategic position is concerned with the impact on strategy of the external environment, internal resources and competences, and the expectations and influence of stakeholders. Strategic choices involve understanding the underlying bases for future strategy at both the corporate and business unit levels and options for developing strategy in terms of both the directions and methods of development. Strategy into action is concerned with ensuring that strategies are working in practice.

Difference between Strategic Management and Operational Management

Strategic Management is ambiguous/uncertain, complex, organisation wide, fundamental and has long term implications. On the other hand, **operational management** is routinised, operationally specific and has short term implications.



The Advantages of Strategic Management

- **Discharges Board Responsibility**

The first reason that most organizations state for having a strategic management process is that it discharges the responsibility of the Board of Directors.

- **Forces an Objective Assessment**

Strategic management provides a discipline that enables the board and senior management to actually take a step back from the day-to-day business to think about the future of the organization. Without this discipline, the organization can become solely consumed with working through the next issue or problem without consideration of the larger picture.

- **Provides a Framework for Decision-Making**

Strategy provides a framework within which all staff can make day-to-day operational decisions and understand that those decisions are all moving the organization in a single direction. It is not possible (nor realistic or appropriate) for the board to know all the decisions the executive director will have to make, nor is it possible (nor realistic or practical) for the executive director to know all the decisions the staff will make. Strategy provides a vision of the future, confirms the purpose and values of an organization, sets objectives, clarifies threats and opportunities, determines methods to leverage strengths, and mitigate weaknesses (at a minimum). As such, it sets a framework and clear boundaries within which decisions can be made. The cumulative effect of these decisions (which can add up to thousands over the year) can have a significant impact on the success of the organization. Providing a framework within which the executive director and staff can make these decisions helps them better focus their efforts on those things that will best support the organization's success.

- **Supports Understanding & Buy-In**

Allowing the board and staff participation in the strategic discussion enables them to better understand the direction, why that direction was chosen, and the associated benefits. For some people simply knowing is enough; for many people, to gain their full support requires them to understand.

- **Enables Measurement of Progress**

A strategic management process forces an organization to set objectives and measures of success. The setting of measures of success requires that the organization first determine what is critical to its ongoing success and then forces the establishment of objectives and keeps these critical measures in front of the board and senior management.

- **Provides an Organizational Perspective**

Addressing operational issues rarely looks at the whole organization and the interrelatedness of its varying components. Strategic management takes an organizational perspective and looks at all the components and the interrelationship between those components in order to develop a strategy that is optimal for the whole organization and not a single component.

The Disadvantages of Strategic Management

- **The Future Doesn't Unfold as Anticipated**

One of the major criticisms of strategic management is that it requires the organization to anticipate the future environment in order to develop plans, and as we all know, predicting the future is not an easy undertaking. The belief being that if the future does not unfold as anticipated then it may invalidate the strategy taken. Recent research conducted in the private sector has demonstrated that organizations that use planning process achieve better performance than those organizations who don't plan - regardless of whether they actually achieved their intended objective. In addition, there are a variety of approaches to strategic planning that are not as dependent upon the prediction of the future.

- **It Can be Expensive**

There is no doubt that in the not-for-profit sector there are many organizations that cannot afford to hire an external consultant to help them develop their strategy. Today there are many volunteers that can help smaller



organizations and also funding agencies that will support the cost of hiring external consultants in developing a strategy. Regardless, it is important to ensure that the implementation of a strategic management process is consistent with the needs of the organization, and that appropriate controls are implemented to allow the cost/benefit discussion to be undertaken, prior to the implementation of a strategic management process.

- **Long Term Benefit vs. Immediate Results**

Strategic management processes are designed to provide an organization with long-term benefits. If you are looking at the strategic management process to address an immediate crisis within your organization, it won't. It always makes sense to address the immediate crises prior to allocating resources (time, money, people, opportunity, cost) to the strategic management process.

- **Impedes Flexibility**

When you undertake a strategic management process, it will result in the organization saying "no" to some of the opportunities that may be available. This inability to choose all of the opportunities presented to an organization is sometimes frustrating. In addition, some organizations develop a strategic management process that become excessively formal. Processes that become this "established" lack innovation and creativity and can stifle the ability of the organization to develop creative strategies. In this scenario, the strategic management process has become the very tool that now inhibits the organization's ability to change and adapt.

The strategic development routes:

- (i) **Intended strategy:** an expression of interest of desired strategic direction deliberately formulated or planned by managers.
- (ii) **Realised strategy:** the strategy actually being followed by an organisation in practice.
- (iii) **Unrealised strategy:** the strategy that does not come about in practice or only partially so. There may be all sorts of reasons for this; the plans are unworkable; the environment changes after the plan has been drawn up and managers decides that the strategy, as planned should not be put into effect, or people in the organisation or influential stakeholders do not go along with the plan.
- (iv) **Imposed strategy:** there may be situations in which managers face what they see as the imposition of strategy by agencies or forces external to the organisation. Government may dictate a particular strategic course or direction- for e.g. in the public sector, or where it exercises extensive regulation in the public sector.
- (v) **Emergent strategy:** unplanned responses to unforeseen circumstances. They arise from autonomous action by individual managers deep within the organisation, from serendipitous discoveries or events, or from an unplanned strategic shift by the top-level managers in response to changed circumstances. They are not the product of formal top-down planning mechanism.

Strategic Fit and Strategic Stretch:

Strategy can be seen as **matching the resources** and activities to the environment in which it operates. This is sometimes known as the search of strategic fit. The notion of *strategic fit* is developing strategy by identifying opportunities in the business environment and adapting resources and competences so as to take advantage of these. Strategy can also be seen as building on or *stretching* an organisation's resources and competences to create new opportunities or to capitalise on them. Stretch is the leverage of the resources and competences of an organization to provide competitive advantage and /or yield new opportunities.

Strategic Management Framework:

The basic framework of strategic management involves five stages:

Stage 1: In this stage, organisation analyse about their present situation in terms of their Strengths, Weaknesses, Opportunities and Threats.

Stage 2: In this stage, organisations setup their missions, goals and objectives by analysing where they want to go in future.



Stage 3: In this stage organisation analyses various strategic alternatives to achieve their goals and objectives. The alternatives are analysed in terms of what business portfolio/product mix to adopt, expansion, merger, acquisition and divestment options etc are analysed to achieve the goals.

Stage 4: In this organisations select the best suitable alternatives in line with their SWOT analysis

Stage 5: This is implementation stage in which organisation implement and execute the selected alternatives to achieve their strategic goals and objectives.

Stage 1: Where are we now? Analysis of present situation

Stage 2: Where we want to go? Setting goals and objectives for future

Stage 3: Analyses of various alternatives to achieve the goals and objectives

Stage 4: Selecting best alternatives in line with strengths of organisation

Stage 5: Implementing and executing the selected alternatives and monitoring of the same overtimes

Strategic Management Framework

Importance of Strategic Management:

- (i) Discover organisation strengths and weaknesses
- (ii) Identify the available opportunities and possible threats
- (iii) Discover the objectives and goals in line with organisations strengths and available opportunities
- (iv) Implement changes to overcome weaknesses and manage the threats.
- (v) Provide vision/mission or direction to future of organisations
- (vi) Build a dynamic and strong organisation
- (v) Help to achieve growing and stable organisation.

Strategic Management Process:

1. Introduction

Strategic management is a process or series of steps.

The basic steps of the strategic management process are (presented in figure)

- (a) identifying or defining business mission, purpose and objectives,
- (b) environmental (including global) analysis to identity present and future opportunities and threats,
- (c) organisational analysis to assess the strengths and weaknesses of the firm,
- (d) developing alternative strategies and choosing the best strategy,
- (e) strategy implementation, and
- (f) strategic evaluation and control.

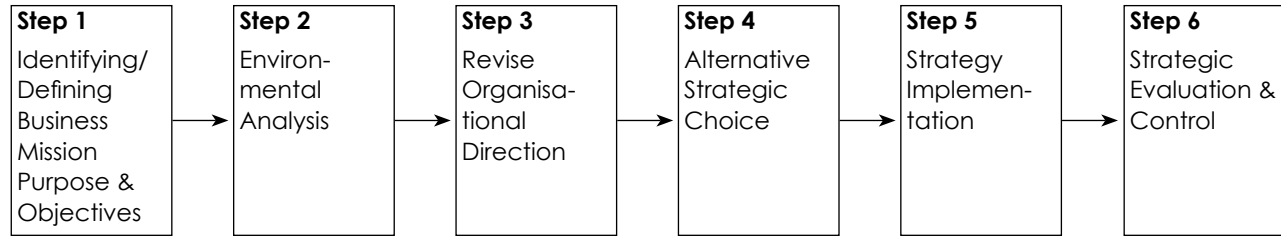

Major Steps in Strategic Management Process

Steps of Strategic Management Process:

Step 1: Identifying Defining Business Mission, Purpose and Objectives: Identifying or defining an organisation's existing mission, purpose and objectives is the logical starting point as they lay foundation for strategic management. Every organisation has a mission, purpose and objectives, even if these elements are not consciously designed, written & communicated. These elements relate the organisation with the society and states that it has to achieve for itself and to the society.

Step 2: Environmental Analysis: Environmental factors — both internal environment and external environment — are analysed to:

- (i) identify changes in the environment,
- (ii) identify present and future threats and opportunities, and
- (iii) assess critically it's own strengths and weaknesses.

Organisational environment encompasses all factors both inside and outside the organisation that can influence the organisation positively and negatively. Environmental factors may help in building a sustainable competitive advantage.

Step 3: Revise Organisational Direction: A thorough analysis of organisation's environment pinpoints it's strengths, weaknesses, opportunities and threats (SWOT). This can often help management to reaffirm or revise it's organisational direction.

Step 4: Strategic Alternatives and Choice: Many alternative strategies are formulated based on possible options and in the light of organisational analysis and environmental appraisal. Alternative strategies will be ranked based on the SWOT analysis. The best strategy out of the alternatives will be chosen.

The steps from identification of business mission, purpose and objectives of alternative strategies and choice can be grouped into the broad step of strategy formulation.

Step 5: Strategy Implementation: The fifth step of strategic management process is the implementation of strategy. The logically developed strategy is to be put into action. The organisation can not reap the benefits of strategic management, unless the strategy is effectively implemented.

The managers should have clear vision and idea about the competitor's strategy, organisation's culture, handling change, skills of the managers-in-charge of implementation and the like. The progress from the stage of identification of business mission, purpose and objectives to the stage of achieving desired performance must overcome many obstacles.

Step 6: Strategic Evaluation and Control: The final step of strategic management process is strategic evaluation and control. It focuses on monitoring and evaluating the strategic management process in order to improve it and ensure that it functions properly. The managers must understand the process of strategic control and the role of strategic audit to perform the task of control successfully.

Strategic management process is presented as a series of discrete steps for the purpose of simplicity in the learning process. But, managers find that an organisation's strategic management effort requires that they perform several steps simultaneously and/or perform them in different order as presented in Figure below:

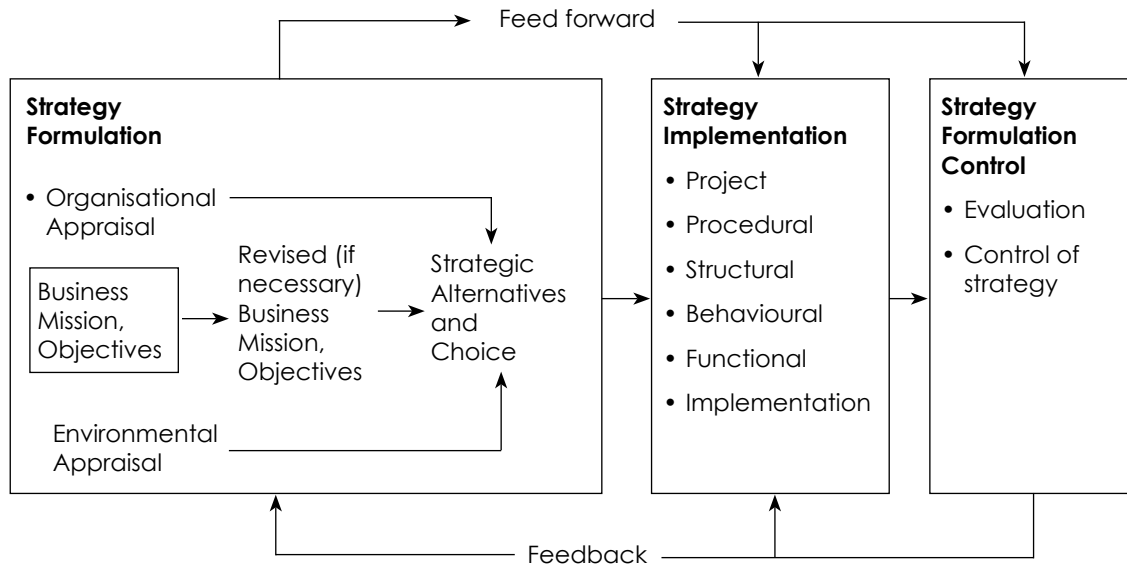

Strategic Management Process Model

VISION

Vision is a statement of the future. It articulates the basic characteristic that shape organisations strategy. It indicates where the organisation is headed and what it intends to be.

Vision, Mission and Objectives in Business:

'Strategy Formulation' i.e. developing vision, mission, objectives and goals is the most important step of strategic management model. This step is considered as a path forming step, and provides the direction to organisation for movement in future.

Vision: There is a quote that 'great visionary can foresee the future in advance and take steps accordingly to be at forefront'.

So, we can conclude that;

1. Vision provide a road map to Company's future
2. Vision indicates the kind of company management is trying to create for future.
3. Vision specifies about company intention and capabilities to adapt to new technologies
4. Vision also specifies management policies towards customers and societies.

A strategic vision

A strategic vision describes management's aspirations for the future and delineates the company's strategic course and long term direction. Well conceived visions are *distinctive* and *specific* to a particular organisation; they avoid generic, feel-good statements. A number of organisations have summed up their visions in a brief phrase for e.g.

- Nike: 'To bring innovation and inspiration to ever athlete in the world.'
- Scotland Yard: 'to make London the safest major city in the world.'



- Dabur: 'Dedicated to the health and well being of every household.'
- Infosys: 'To be a globally respected corporation that provides best-of- breed business solutions, leverage technology, delivered by best- in class people.'

Strategic vision specifies primarily three elements:

1. Forming a mission statement that defines what business the company presently is in? And "who we are and where we are now?"
2. Using this mission statement as base to define long term path by indicating choices about "Where we are going?"
3. Finally, communicating above strategic vision in clear and committed term.

Strategic Vision has important purposes, such as:

1. Clearly provide the direction that company wants to follow
2. Identify the need of changing from existing direction or products, if stated in vision statement.
3. Create passionate environment in the organisation to steer the company with great excitement in selected direction.
4. Create creativity in every member of company to prepare company for future.
5. Promote entrepreneurship.

The benefits of having a Vision

According to Parikh and Neubauer (1993), a well construed vision can provide the following benefits:

- Good visions are inspiring and exhilarating.
- Vision represents a discontinuity, a step function and a jump ahead so that the company knows what it is to be.
- Good vision helps in the creation of a common identity and a shared sense of purpose.
- Good visions are competitive, original and unique. They make sense in the market place as they are practical.
- Good visions foster risk taking and experimentation.
- Good visions foster long term thinking
- Good visions represent integrity: they are truly genuine and can be used to the benefit of the people.

MEANING AND USE OF MISSION:

The term 'mission' implies the fundamental and enduring objectives of an organisation that set it apart from other organisations of similar nature. The mission is a general enduring statement of instruction of an organisation. The corporate mission is the purpose or reason for its existence. It refers the philosophy of business to the static decision maker to build the image of the company. The corporate mission highlights the organisation self-concept and indicates the nature of product or service to be offered or rendered for fulfillment of the requirements of the customers as also for the community and society as a whole.

The mission may, as such, be described as the scope of operations in terms of product, market or the service as well as customers and clients. An organisation may define its mission highlighting the philosophy and purpose. The philosophy establishes the values, beliefs and guidelines for the business plan and business operation.

The mission of a firm defines its reasons for existence.

A company's mission describes its purpose and its present business (who we are, what we do and why we are here). It announces what the company is providing to society; either a service or a product. A well conceived



mission statement defines the fundamental, unique purpose that sets a company apart from other firms of its type and identifies the scope or domain of the company's operations in terms of products offered. A mission statement may also include the firm's values and philosophy about how it does business and treats its employees; however, that is usually better kept as a separate document. In simple terms, a mission statement promotes a sense of shared expectations in employees and communicates a public image to important stakeholder groups in the company's task environment.

The mission statement of an organisation can be either product oriented or customer oriented. A product-oriented business definition focuses on the characteristics of the products sold and the markets served, not on which kinds of customer needs the products are satisfying. Such an approach obscures the company's true mission because a product is only the physical manifestation of applying a particular skill to satisfy a particular need for a particular customer group. A customer-oriented view of a company's business focuses on customer needs rather than a particular product (or solution) for satisfying those needs. The need is to take customer-oriented view of a company's business has often been ignored. A broad customer-oriented business definition identifies the ways to safeguard companies from being caught unaware by major shifts in demand. A customer-oriented mission statement also assists companies in capitalizing on changes in their environment.

Mission statement of some organisations and the nature of the statement

- *Bharat Gas: To make Bharat Gas a dominant brand in the segments we market, by becoming trendsetters in customer service, safety and quality. (It is a customer oriented mission statement).*
- *Nirma: Nirma is a customer focused company committed to consistently offer better quality products and services that maximise value to the customer. (It is a customer oriented mission statement).*
- *Microsoft corporation: to empower every person and every organisation on the planet to achieve more. (It is a customer oriented mission statement).*

Mission includes:

- A definition of products and services the organisation provides.
- Technology used to provide these products and services.
- Types of markets.
- Customer need or requirement.
- Distinctive Competencies.

Organisational Mission and Objectives: In one way, objective setting is the starting point of strategy formulation. Organisations, being deliberate and purposive creations, have some objectives. The ends for which they strive are referred to as 'mission,' 'purpose,' 'objective', 'goal', or 'target'. Though there are differences in these terms, often the differences are not emphasised and these terms are used interchangeably in practice to denote the end results for which organisations strive. However, the end results of organisations, or their parts, can be defined in various ways. For example, these can be defined in quantitative terms to be achieved in specific time or may be defined in some general terms without reference to any time period. In these two cases, the end results have been expressed, however, the emphasis is different. Thus some distinction can be made in these terms.

Purpose and Mission: An organisation's purpose and mission consist of a long-term vision of what it seeks to do and the reasons why it exists. Purpose is management's concept of the organisation and its service mission to society. An organisation's purpose, when expressed in managerially meaningful terms, indicates exactly what activities the organisation intends to engage in now and in future. It suggests something specific about what kind of organisation it is and is to become. It depicts the organisation's business character and does so in ways that tend to distinguish the organisation from other organisations. Thus purpose and mission can be defined as follows:

The purpose and mission of an organisation is a general enduring statement of the organisation the intent of which embodies the decision maker's business philosophy; it implies the image which the organisation seeks to project.

In this sense, purpose sets forth principles and conceptual foundation upon which the organisation rests and the nature of the business in which it plans to participate. Organisational mission, defined properly, offers guidance to managers in developing sharply focused, result-oriented objectives, strategies, and policies. Therefore, a detailed



understanding of organisational mission is the starting point for rational managerial action and for the design of organisation structure, processes, and procedures. Managerial effectiveness tends to begin with clarity of mission with an accurate, carefully delineated concept of just what the organisation is trying to do and why.

A key feature of organisation's purpose is that its focus must be external rather than internal. For example, Drucker has the following suggestion: 'To know what a business we have to start with is its purpose. Its purpose must lie outside the business itself. In fact, it must lie in society since business enterprise is an organ of society. There is only one valid definition of business purpose to create a customer.

DEFINING THE COMPANY MISSION

What is a Company Mission?

The mission is a broadly framed but enduring statement of company intent. It embodies the business philosophy of strategic decision makers; implies the image the company seeks to project; reflects the firm's self-concept; indicates the principal product or service areas and primary customer needs the company will attempt to satisfy. In short, the mission describes the product, market, and technological areas of emphasis for the business. And it does so in a way that reflects the values and priorities of strategic decision makers.

The mission of a business is the fundamental, unique purpose that sets it apart from other firms of its type and identifies the scope of its operations in product and market terms. The mission is a general, enduring statement of company intent. It embodies the business philosophy of strategic decision makers, implies the image the company seeks to project, reflects the firm's self-concept, and indicates the principal product or service areas and primary customer needs the company will attempt to satisfy. In short, the mission describes the product, market, and technological areas of emphasis for the business in a way that reflects the values and priorities of the strategic decision makers.

The Need for an Explicit Mission:

Defining the company mission is time consuming, tedious, and not required by any external body. The mission contains few specific directives, only broadly outlined or implied objectives and strategies. Characteristically, it is a statement of attitude, outlook, and orientation rather than of details and measurable targets.

What then is a company mission designed to accomplish?

1. To ensure unanimity of purpose within the organisation.
2. To provide a basis for motivating the use of the organisation's resources.
3. To develop a basis, or standard, for allocating organisational resources.
4. To establish a general tone or organisational climate, for example, to suggest a businesslike operation.
5. To serve as a focal point for those who can identify with the organisation's purpose and direction, and to deter those who cannot from participating further in the organisation's activities.
6. To facilitate the translation of objectives and goals into a work structure involving the assignment of tasks to responsible elements within the organisation.
7. To specify organisational purposes and the translation of these purposes into goals in such a way that cost, time, and performance parameters can be assessed and controlled.

Formulation of Organisational Mission:

Organisation can not declare the mission just on some great whim and fancy, it should be based on organisations' existing capabilities and achievable milestones. Here are some guidelines for formulation of "mission" statement

- It should be based on existing business capabilities "Who we are and what we do?"
- It should follow the long term strategy principles
- Profit making should not be the only mission of organisation
- It should be logical extension of business existing capabilities
- It should clearly and precisely present the future orientation of business



- It should include achievable missions
- It should be stated in a form that it becomes the motivating force to every member of organisation
- Mission statement once formed shall be communicated to every member of organisations
- It should include interest of customers and society

Organisational mission encompasses the broad aims of the organisation; it defines what for the organisation strives. Therefore, the process of defining the mission for any specific organisation can be best understood by thinking about it at its inception. An organisation begins with the beliefs, desires, and assumptions of single entrepreneur. These beliefs, desires and assumptions may be of the following nature:

1. The product and service offered by the organisation can provide benefits at least equal to its price.
2. The product or service can satisfy the needs of the customers not adequately served by others presently.
3. Technology used in producing product or service will be cost and quality competitive,
4. The organisation can grow and be profitable than just survive in the long run with the support of various constituents.
5. The organisation will create favourable public image which will result in contributions from the environment.
6. Entrepreneur's self-concept of the business can be communicated and adopted by employees and stakeholders.
7. The organisation will be able to satisfy the entrepreneur's needs and aspirations which he seeks to satisfy through the organisation.

At the initial stage, the above elements go into mission formulation. As the organisation grows or is forced by competitive forces to alter its product, market, and technology, there may be need for redefinition of the mission. However, the revised mission will reflect the same set of elements as the original—like type of product to be offered, type of customer to be served, type of technology to be employed, growth of organisation, favourable public image, self-concept of entrepreneur, and needs and aspirations of entrepreneur, though in modified form.

Distinction between a strategic vision and a company's mission statement

The distinction between a strategic vision and a company's mission statement is fairly cut. A strategic vision portrays a company's aspirations for its future (where we are going), whereas a company's mission describes its purpose and its present business (who we are, what we do and why we are here).

Objectives, Goals and Targets:

We frequently use the term organisation's "objectives and goals", the term "objective and goals" set target of any particular aspect like profit and revenue growth, etc.

Here are some common definitions of Objectives;

- Objectives are performance targets which organisations want as result or outcomes in the specified periods
- Objectives achievements are used as benchmark of organisation performance and success
- Objectives are formed from visions and mission statement of organisations
- Objectives are interchangeably used with goals but goals are defined as more precise and specific with closed ended attribute (in precise quantity form) whereas objectives are open ended for future states or outcome not as precise as goals. Objectives are for long term whereas goals are for short term.

Characteristics of Objectives: Objectives characterise business long-term prospective, such as:

- Facilitate to achieve mission and goals
- Set the basis for strategic decision making
- Clear the relationship of organisation with environment
- Should be understandable by each member of organisation
- Should be measurable and controllable



- Should be related to time frame
- Should be challenging
- Should be concrete and specific
- Should be formed within the constraints
- Should motivate people.

Formal strategies contain three elements:

1. Goals to be achieved.
2. Policies that guide or limit action.
3. Action sequences or programs that accomplish goal.

Effective strategic revolve around the key concepts or thrust area such as customer satisfaction or customer focus.

Concept of Strategic Intent:

Here intent refers to intension. A company exhibits strategic intent when it relentlessly (aggressively) pursues an ambitious strategic objective and concentrates it's full resources and competitive actions on achieving that objective.

A company's strategic intent can helps in many ways to the company, like:

- in becoming the dominant company in the industry;
- unseating the existing industry leader;
- delivering the best customer service in the industry (or the world);
- turning new technology into products which capable of changing the way people work and live.

Innovations that make their production systems unexpectedly obsolete (technological).

Objectives and Goals: The literature of management is filled with references to objectives and goals. These terms are used in a Varsity of ways, many of them conflicting. First, these terms are used interchangeably meaning one and the same thing. Therefore, there is no difference between the two. To make distinction between long-term and short-term orientations, these prefixes are used either with objectives or goals. Second, some authors use goals as the long-term results which an organisation seeks to achieve and objectives as the short-term results. Third, some writers reverse the usage referring to objectives as the desired long-term results and goals as the desired short-term results. This latter view is, however, more prevalent. From this point of view, Ackoff has defined both the terms as follows:

'Desired states or outcomes are objectives. Goals are objectives that are scheduled for attainment during planned period'. Thus objectives and goals defined in this way convey two different concepts.

The distinction between these two concepts is important because strategic management needs both. The difference between objectives and goals may be drawn in terms of the following four dimensions.

1. **Time Frame.** Objectives are timeless, enduring, and unending; goals are temporal, time-phased, and intended to be superseded by subsequent goals. Because objectives relate to' the ongoing activities of an organisation, their achievement tends to be open-ended in the sense of not being bounded by time. For example, the survival objective of a business organisation is never completely attained since failure is always a future possibility.
2. **Specificity.** Objectives are stated in broad, general terms, dealing with matters of image, style, and self-perception. These are aspirations to be worked in the future. Goals are much more specific, stated in terms of a particular result that will be accomplished by a specific date. In the above example, survival as an objective is not very specific because it leads to different interpretation of the stale of survival. On the other hand, goals can be expressed in terms of say achievement of 10 per cent growth in the net sales in the next year. This is more specific and time bound.



- 3. Focus.** Objectives are usually stated in terms of some relevant environment which is external to the organisation; goals are more internally focused and carry important implications about how resources of the organisation are utilised or will be utilised in future. Therefore, objectives are more generalised statements like maintaining market leadership, striving continuously for technological superiority, etc. A goal may imply a resource commitment requiring the organisation to use those resources in order to achieve the desired outcomes.
- 4. Measurement.** Both objectives and goals can be stated in terms which are quantitatively measured but the character of measurement is different. Generally, quantitative objectives are set in relative terms. For example, Reliance Textiles has put its objectives like this: to acquire top position among the Indian companies. This objective may not be achieved in any one year, but it is timeless and externally focused, providing a continuing challenge for the company. Quantitative goals are expressed in absolute terms. For example, a company has stated its goal to achieve 10 per cent growth in its sales in the next year. The achievement of this goal can be measured irrespective of environmental conditions and competitors' actions.

Thus objectives are more specific as compared to the purpose or mission of the organisation. However, these are expressed in such terms which can be followed continuously. For example, a private sector company has declared as follows:

The main objective of the company is to manufacture and distribute both consumer and industrial products of high quality to our customers in India and abroad at a minimum price which will return a reasonable profit to the company. This company will expand and diversify its activity as necessary to meet the needs of the customers to render better service/to obtain better quality, or to effect economies in operation.

Company Goals: Survival, Growth, Profitability

Three economic goals guide the strategic direction of almost every viable business organisation. Whether or not they are explicitly stated, a company mission statement reflects the firm's intention to secure its survival through sustained growths and profitability.

Unless a firm is able to survive, it will be incapable of satisfying any of its stakeholders' aims. Unfortunately, like growth and profitability, survival is such an assumed goal that it is often neglected as a principal criterion in strategic decision making. When this happens, the firm often focuses on short-term aims at the expense of the long run.

Profitability is the mainstay goal of a business organisation. No matter how it is measured or defined, profit over the long term is the clearest indication of a firm's ability to satisfy the principal claims and desires of employees and stockholders. The key phrase in the sentence is "over the long term". Obviously, basing decisions on a short-term concern for profitability would lead to a strategic myopia. A firm might overlook the enduring concerns of customers, suppliers, creditors, ecologists, and regulatory agents. In the short term the results may produce profit, but over time the financial consequences are likely to be detrimental.

The following excerpt from the Hewlett-Packard Company's statement of corporate objectives (i.e., mission) aptly expresses the importance of an orientation toward long-term profit:

To achieve sufficient profit to finance our company growth and to provide the resources we need to achieve our other corporate objectives.

In our economic system, the profit we generate from our operations is the ultimate source of the funds we need to prosper and grow. It is the one absolutely essential measure of our corporate performance over the long term. Only if we continue to meet our profit objective can we achieve our other corporate objectives.

A firm's growth is inextricably tied to its survival and profitability. In this context, the meaning of growth must be broadly defined. While growth in market share has been shown by the product impact market studies (PIMS) to be correlated with firm profitability, other important forms of growth do exist. For example, growth in the number of markets served, in the variety of products offered, and in the technologies used to provide goods or services frequently leads to improvements in the company's competitive ability. Growth means change, and proactive change is a necessity in a dynamic business environment. Hewlett-Packard's mission statement provides an excellent example of corporate regard for growth:

To let our growth be limited only by our profits and our ability to develop and produce technical products that satisfy real customer needs.



We do not believe that large size is important for its own sake; however, for at least two basic reasons continuous growth is essential for us to achieve our other objectives.

In the first place, we serve a rapidly growing and expanding segment of our technological society. To remain static would be to lose ground. We cannot maintain a position of strength and leadership in our field without growth.

In the second place, growth is important in order to attract and hold high-caliber people. These individuals will align their future only with a company that offers them considerable opportunity for personal progress. Opportunities are greater and more challenging in a growing company.

The issue of growth raises a concern about the definition of a company mission. How can a business specify product, market, and technology sufficiently to provide direction without delimiting unanticipated strategic options? How can a company define its mission so opportunistic diversification can be considered while at the same time maintaining parameters that guide growth, decisions? Perhaps such questions are best addressed when firm outlines-Objectives its mission conditions under which it might depart from ongoing operations. The growth philosophy of Dayton-Hudson shows this approach:

The stability and quality of the corporation's financial performance will be developed through the profitable execution of our existing businesses, as well as through the acquisition or development of new businesses. Our growth priorities, in order, are as follows:

- (i) Development of the profitable market preeminence of existing companies in existing markets through new store development or new strategies within existing stores;
- (ii) Expansion of our companies to feasible new markets;
- (iii) Acquisition of other retailing companies that are strategically and financially compatible with Dayton-Hudson;
- (iv) Internal development of new retailing strategies.

Capital allocations to fund the expansion of existing operating companies will be based on each company's return on investment, in relationship to its return-on-investment (ROD objective and its consistency in earnings growth, and on its management capability to perform up to forecasts contained in capital requests.

Expansion via acquisition or new venture will occur when the opportunity promises an acceptable rate of long-term growth and profitability, acceptable degree of risk, and compatibility with the corporation's long-term strategy.

Mission and Strategy:

Mission sets the direction for the strategic development of the organisation. As Drucker remarks in his *Managing for the Future*, the mission "focuses the organisation on action. It defines the specific strategies needed to attain the crucial goals. It creates a disciplined organisation. It alone can prevent the most common degenerative disease of organisations, especially large ones, splintering their always limited resources on things that are 'interesting' or look 'profitable' rather than concentrating them on a very small number of productive efforts". There are several examples of organisations which substantially developed their business or improved their performance by refocusing their business. "Corporate mission statements are the operational, ethical and financial guiding lights of companies. They are not simply mottoes or slogans; they articulate the goals, dreams, behaviour, culture, and strategies of companies".

One great advantage of formulation of the mission is that it also results in a clear definition of the business of a company. Mission statement and definition of the business are indeed two sides of the same coin.

Dereck Abell has suggested defining business along three dimensions, viz, customer groups (i.e., who is being satisfied) customer functions (i.e., what need of the customer is being satisfied) and alternative technologies (i.e., how the need is being satisfied). Such a three dimensional definition of the business would clearly delineate the boundaries and nature of the business. However, not many mission statements are so clear and comprehensive.

As Drucker suggests three fundamental questions would help to clearly define / redefine the business and formulate/reformulate the mission. These questions are:

- What is our business?
- What will our business be?
- What should our business be?



The question 'what is our business'? May lead to wonderful revelations and spectacular results. Drucker points out that most managers ask their question when the company is in trouble - then it must of course, be asked; but the most important time to ask this seriously is when a company has been successful and not to have done so is the reason for the crisis of many organisations.

It is, thus, evident that as the business environment is very dynamic, sooner or later even the most successful answer to the question what is our business, becomes obsolete. Therefore, it is not sufficient that a company determines what it's business is but at the same time it should also ponder over what will it be? 'What changes in the environment are already discernible those are likely to have high impact on the characteristics, mission, and purpose of our business? And how do we now build these anticipations into our theory of business, into it's objectives, strategies and work assignments?'

It is not adequate that a company identifies what will it's business be? Because this aims at adaptation to anticipated changes - modifying, extending, and developing the existing ongoing business. It does not explore the right firm - environment fit for the future. The future may have new or better opportunities outside the current business of the company, or it may not be wise to continue in all or some of the current businesses. There is, therefore, a need to ask 'what should our business be?' This question is the central point of corporate strategy.

As Drucker aptly remarks, the ultimate objective of strategic planning is "to identify the new and different businesses, technologies, and markets which the company should try to create long range. Indeed, it starts with the question which of our present businesses should we abandon? Which should we play down? Which should we push and supply new resources to

Mission is meaningless unless it is adequately supported by other essential inputs. It is very apt to record here Amban's statement about what made the Reliance one of Asia's most competitive enterprises: "It has been a combination of vision, entrepreneurship and professionalism".

In sum, as Drucker remarks, "without an effective mission statement there will be no performance. The mission statement has to express the contribution the enterprise plans to make to society, to economy, to the customer. It has to express the fact that the business enterprise is an institution of society, and serves to produce social benefits".

Policy and Strategy:

A policy is a broad guideline for decision making that links the formulation of a strategy with its implementation. Companies use policies to make sure that employees throughout the organisation make decisions and take actions that support the corporation's mission, objectives and strategies. Some examples of company policies are as follows:

- General Electric: GE must be number one or two wherever it competes. (This supports GE's objectives to be number one in market capitalisation).
- 3M: 3M says researchers should spend 15% of their time working on something other than their primary project. (This supports 3M's strong product development strategy).

Tactic or a Program:

A tactic or a program is a statement of the activities or steps needed to support a strategy. The terms are interchangeable. In practice, a program is a collection of tactics where a tactic is the individual action taken by the organisation as a n element of the effort to accomplish a plan. A program or a tactic makes a strategy action-oriented.

Example of an objective and a set of programs or tactics.

BMW

Objective: to increase production efficiency by 5% each year

Tactics: (i) shorten new model development time form 60 to 30 months, (ii) reduce preproduction time from a year to not more than 5 months, and (iii) build atleast two vehicles in each plant so that production can shift among models depending upon demand.

STRATEGIC LEVELS IN ORGANISATION

There are primarily three levels of strategies in the organisation.

1. Corporate Level
2. Business Level
3. Functional Level



1. Corporate Level:

The corporate level of management consists of the chief executive officer (CEO), other senior executives, the board of directors, and corporate staff. These individuals occupy the top-committee of decision making within the organisation. The CEO is the principal general manager. In consultation with other senior executives, the role of corporate-level managers is to oversee the development of strategies for the whole organisation. This role includes defining the mission and goals of the organisation, determining what businesses it should be in, allocating resources among the different businesses, formulating and implementing strategies that span individual businesses, and providing leadership for the organisation. For example, strategies formed for Unilever Limited would be at corporate level.

2. Business Level:

A business unit is a self-contained division (with its own functions-for example, finance, purchasing, production, and marketing departments) that provides a product or service for a particular market. The principal general manager at the business level, or the business-level manager, is the head of the division. The strategic role of these managers is to translate the general statements of direction and intent that come from the corporate level into concrete strategies for individual businesses. Thus, whereas corporate-level general managers are concerned with strategies that span individual businesses, business-level general managers are concerned with strategies that are specific to a particular business. At GE, a major corporate goal is to be first or second in every business in which the corporation competes. Then the general managers in each division work out for their business the details of a strategy that is consistent with this objective. For example, strategies formed for Kwality Walls, a subsidiary of Unilever Limited would be at business level.

3. Functional Level:

Functional-level managers are responsible for the specific business functions or operations (human resources, purchasing, product development, customer service, and so on) that constitute a company or one of its divisions. Thus, a functional manager's sphere of responsibility is generally confined to one organisational activity, whereas general managers oversee the operation of a whole company or division. Although they are not responsible for the overall performance of the organisation, functional managers nevertheless have a major strategic role: to develop functional strategies in their area that help fulfill the strategic objectives set by business & corporate-level general managers. Moreover, functional managers provide most of the information that makes it possible for business & corporate-level general managers to, formulate realistic and attainable strategies. Indeed, because they are closer to the customer than the typical general manager is, functional managers themselves may generate important ideas that subsequently may become major strategies for the company. Thus, it is important for general managers to listen closely to the ideas of their functional managers. An equally great responsibility for managers at the operational level is strategy implementation: the execution of corporate and business-level plans. For example, strategies formed for employee retention by HR manager at Kwality Walls would be at functional level.

Self Learning Questions:

1. What do you mean by Strategy? State its features.
2. What do you mean by Strategy Management? Discuss the framework of Strategic Management.
3. State the importance of Strategic management?
4. Discuss in brief the strategic Management process.
5. What is the guideline in formulation of Mission Statement?
6. Discuss the various Strategic Level in an Organisation.
7. What are the difference between vision and mission?
8. Discuss in brief the formulation of Organisational Mission.
9. Distinguish between Objectives and Goals of business.
10. Developing annual objectives & short term objective strategies that are compatible with the selected set of long term objective are one of the major tasks of strategic Management. Critically comment.

Study Note - 9

STRATEGIC ANALYSIS AND STRATEGIC PLANNING



This Study Note includes

- 9.1 Situational Analysis
- 9.2 SWOT Analysis
- 9.3 Portfolio Analysis
- 9.4 BCG Matrices
- 9.5 Stages in Strategic Planning
- 9.6 Alternative in Strategic Planning
- 9.7 Pestel Framework
- 9.8 Porter's Five Forces Framework
- 9.9 Structural Drivers of Chance
- 9.10 Diversification Strategy

9.1 SITUATIONAL ANALYSIS

Introduction

The strategic management process, after deciding the vision, mission, goals and objectives of the organization, turns its focus to scanning of both external environment and internal environment.

Situational Analysis:

A company's macro environment consists of all related dimensions and influences outside the company's boundaries; by relevant factors like direction, objectives, strategy, and business model. But influences coming from the outer globe of the macro environment have a small impact on a company's business situation. They only shape the limits of the company's direction and strategy. There are sufficient amount of strategically relevant trends and developments in the macro environment. As company managers scrutinize the external environment, they must examine for potentially important environmental forces, assess their impact and influence, and adapt the company's direction and strategy as needed.

Enterprises and businesses worldwide carry out analyses to assess conditions and environment for strategic planning. Every company consists of certain frameworks that permit them to understand the market and analyze their products. Companies carry out market research by conducting surveys to evaluate market requirements and trends. SWOT & PEST analyses are two methods through which companies plan ahead by conducting research.

PEST analysis refers to Political, Economical, Social, and Technological factors which manipulate the business environment. SWOT analysis refers to Strengths, Weaknesses, Opportunity and Threats. These factors are prime determinants of strategic planning. Without SWOT and PEST analysis companies might fail to achieve desired goals.

PEST Analysis looks at external factors and is primarily used for market research. It is used as an alternative to SWOT analysis:

- (i) **Political** – These are the external factors that influence the business environment. Government decisions and policies affect a firm's position and structure, Tax laws, monetary and fiscal policies as well as reforms of labor and workforce, all influence companies in future. These factors are important and need to be managed in order to overcome uncertainty.



- (ii) **Economical** – Economical factors are the most important since it impacts business in the long run. Inflation, interest rates, economic growth and demand/supply trends are to be considered and analyzed effectively before planning and implementing. Economic factors affect both consumers and enterprises.
- (iii) **Social** – Social factors involve the trends of population, domestic markets, cultural trends and demographics. These factors help businesses assess the market and improve their products/service accordingly.
- (iv) **Technological** – This analyses the technology trends and advancements in business environment, innovations and advancements lowers barriers to entry plus decreased production levels as it results in unemployment. This includes research and development activity, automation and incentives.
 - (i) It presents a business' standing and position, i.e. whether it is weak or strong
 - (ii) It informs about both internal and external factors that affect a firm's success and/or failure
 - (iii) It helps firms assess the report and take counter measures for improvement and analyzing threats
 - (iv) It forecasts the future and sheds light on the current situation
 - (v) Evaluates business environment and allows firms to make strategic decisions
 - (vi) Prevents future failure and creates a system of continuous success
 - (vii) Provides companies with a reality check on their performance and shortcoming
 - (viii) Enables firms to understand the economy and market and expand
 - (ix) Provides a mechanism to identify threats and opportunities
 - (x) Enables companies to learn about markets and enter new markets nationally or globally.

Advantages & Disadvantages of PEST & SWOT Analysis

Both SWOT & PEST analyses are simple and easy to list but hard to implement fully. It takes time and research to completely analyze the situation. SWOT analysis might not be able to provide results for each factor plus for the analysis to be successful, it requires expertise which would analyze all possible threats and weaknesses and turn them into strength and opportunity. It requires resources and capital to perform and a positive outcome cannot be guaranteed.

PEST analysis is to be used if the SWOT analysis of a company fails and they need to study markets. It focuses on external factors and not on the firm's internal factors which can cause conflict. PEST analysis works on a macro scale as it includes economic factors. These factors are uncertain and change constantly depending on the state of the country. SWOT analysis is considered the best because it focuses on internal and external factors both while PEST only focuses on external factors. Some top companies like Ford, Microsoft and Sony prefer monthly SWOT analysis as their markets are expanding and growing every month and they consider internal factors of the company important.

Example of situational analysis

Increased government allocations to social sector programs in line with its commitment to inclusive growth, a progressive policy environment, and a slew of social protection schemes, decentralized planning and governance have all impacted the improving lives of India's children and women. But with nearly half a billion children in this country, a lot more remains to be done to make sure the survival, growth and development of India's greatest asset: its children. persistently high malnutrition rates, poor sanitation and persistent disparities between states, social groups and the rich and the poor are just some of the obstacles that India come across in ensuring that every child is reached. The report provides snapshots of the situation of children and women from 18 states of the country. In addition to demographic information of children and women in 18 states, the report details progress against MDGs and child protection indicators. Equity status of key indicators on children and women are also presented for each state.



9.2 SWOT ANALYSIS

Swot Analysis:

Gathering data about the general, operating, and internal environments provides the raw material from which to develop a picture of the organisational environment.

SWOT analysis refines this body of information by applying a general framework for understanding and managing the environment in which an organisation operates. (The acronym SWOT stands for Strengths, Weaknesses, Opportunities, and Threats.) In many respects, the sophisticated analytical techniques discussed throughout the text are further refinements of basic SWOT analysis. In addition, students have repeatedly told us that SWOT is an excellent way to begin a case analysis. SWOT analysis attempts to assess the internal strengths and weaknesses of an organisation and the opportunities and threats that its external environment presents. SWOT seeks to isolate the major issues facing an organisation through careful analysis of each of these four elements. Managers can then formulate strategies to address key issues.

The appraisal should give particular attention to the following.

- (a) A study of past accounts and the use of ratios. By looking at trends, or by comparing ratios (if possible) with those of other firms in a similar industry, it might be possible to identify strengths and weaknesses in major areas of the business. The assistance of a management accountant should be of great value in this work.
- (b) Product position and product-market mix. This very important area is dealt with later.
- (c) Cash and financial structure. If a company intends to expand or diversify, it will need cash or sufficient financial standing in order to acquire subsidiaries by issuing shares.
- (d) Cost structure. If a company operates with high fixed costs and relatively low variable costs, it might be in a relatively weak position with regards to production capacity. High volumes of production and sale might be required to break even. In contrast, a company with low fixed costs might be more flexible and adaptable so that it should be able to operate at a lower breakeven point.
- (e) Managerial ability. There may be a problem in attempting to assess this and objective measurements should be sought. The danger is that a poor management might overestimate their own ability and incorrectly analyse their weakness as strength.

The purpose of the analysis is to express, qualitatively or quantitatively, which areas of the business have strengths to exploit, and which areas have weaknesses which must be improved. Although every area of the business should be investigated, only the areas of significant strength or weakness should warrant further attention.

While finalising the corporate plan together with corporate objectives, growth strategies, it would be necessary to make a review of the corporate strengths and weaknesses in connection with its mission and objectives. This is an important managerial task linked with corporate planning process. Corporate strengths and weaknesses can be broadly enumerated as under:

Corporate Strengths:

Highly professionalised managerial group including directors and the chief executive an environment prevailing for commitments to jobs and responsibility with team spirit by the work force

- (i) Financially very sound
- (ii) Good products and product-mix with high demand including future prospects
- (iii) Full capacity utilisation, locational advantages
- (iv) Good infrastructures
- (v) Good industrial relations
- (vi) No political interference



- (vii) Good performance in production and services with consistent records
- (viii) Good raw materials base
- (ix) Incentives from State Government
- (x) Good relation with Government departments
- (xi) Technologically rich and with expertise

These are the corporate strengths within and outside the organisation.

Corporate Weaknesses:

Similar to Corporate strengths, there may be corporate weaknesses too. These may be enumerated as under:

- (i) Under-utilisation of capacity due to economic slump
- (ii) High debt burden in the capital structure
- (iii) Poor product-mix
- (iv) Lack of managerial strengths
- (v) Industrial unrest
- (vi) Technology gap
- (vii) Demand gap
- (viii) Poor infrastructures
- (ix) Raw materials source at a distance
- (x) Lack of latest information technology
- (xi) Competition war
- (xii) Global threats

Both corporate strength and corporate weaknesses are examined and reviewed together in connection with corporate mission and objectives. A balanced and appropriate mix from both strengths and weaknesses is made in order to formulate a good corporate plan, which can be achieved and fulfilled during its entire plan period.

During these exercises on the corporate plan, all aspects related to the company including its strengths and weaknesses are examined. This exercise includes SWOT analysis.

Now we outline the 'opportunities' and 'threats'.

Opportunities:

The following may be termed as 'Opportunities' which should be timely utilised and availed of by the organisation gainfully:

- (i) Seasonal/climatical demand of products
- (ii) Global markets for the company's products/services (Export opportunities)
- (iii) Rural markets to explore and to penetrate
- (iv) To explore the markets in the undeveloped/under-developed/developing states/places
- (v) To avail of the incentives/concessions declared by Central and State Governments
- (vi) Diversifications opportunities
- (vii) Mergers/acquisition opportunities
- (viii) Good home market available due to boost in the economy
- (ix) Liberalised policies of the Government both at Centre as well as State level for the individual production and industrial developments.



Similar to opportunities, there may be threats too prevailing from time to time, which must be examined and necessary action taken to be free from these or to solve these prudently so that loss to the organisation may be minimum. The probable threats, which may arise or be faced by the organisation, are listed out as under:

Threats:

- (i) Globalisation
- (ii) Competition
- (iii) Price cutting war
- (iv) Free imports
- (v) Industrial unrest
- (vi) Political instability
- (vii) Quality thrusts
- (viii) High and adverse debt equity ratio
- (ix) Increase in financing cost
- (x) Economic slow down due to international recession impact

In the above Para, details of:

- (i) Strengths
- (ii) Weaknesses
- (iii) Opportunities
- (iv) Threats

Each and every factor of the SWOT would be analysed critically to find out a best alternative out of various alternatives available.

9.3 PORTFOLIO ANALYSIS

Portfolio analysis is a term used in describing methods of analysing a product -market portfolio with the following aims.

- (i) To identify the current strengths and weaknesses of an organisation's products in its markets, and the state of growth or decline in each of these markets.
- (ii) To identify what strategy is needed to maintain a strong position or improve a weak one.

Several matrices have been developed over the years to analyse market share, market growth and market position.

Factors influencing Portfolio Strategy:

There are number of factors - historical, personal, strategic, environmental etc. which influence portfolio strategy. Important such factors are given below:

1. **Mission/Vision:** The mission of the company is one of the most important factors which influence, the portfolio strategy because the mission defines the scope and purpose of the company. Formulation of clear vision about the future has let to restricting the portfolio companies like Glaxo.
2. **Value system:** A factor very much complimentary to the mission that influences the portfolio strategy is the value system of the promoters or major stock holders. After the Murugappa group took over the EID Parry,



the liquor business of the EID Parry group was sold off as the Murugappa group management felt that it was unethical to be in the liquor business.

3. **Future of Current Business:** The future prospects of the current business are a very important factor influencing the portfolio strategy. If a current business, particularly the most important one, has a bleak future a company would be tempted to divest or diversify into growing business. Having felt that the future of the tobacco business would be very bleak, the ITC diversified into speciality paper, packaging and printing, hotels, agribusiness, financial services and international business etc. and today the non-tobacco businesses contribute a considerable share of the total turnover of ITC. (Some of these diversifications, however, have not been successful, and the company has, therefore, decided to concentrate more on its core business-tobacco).
4. **Position on the Portfolio Matrix/PLC:** The position of different business on the product portfolio life cycle also may influence the portfolio strategy of a company. Products in the declining stage may be dropped. Similarly some of the dogs or question marks could also be eligible candidates for divestment. Several Indian companies, like the Ceat, have decided to drop businesses which are peripheral or which are not important in terms of business volume or are not otherwise satisfactory in terms of performance and which do not hold out promises for the future of the company. They have adopted the strategy of focusing on the core business (es).
5. **Government Policy:** Government policy sometimes is an important determinant of portfolio strategy. The pre-1991 regulatory regime did not permit many companies, particularly large ones and foreign firms, to pursue the type of growth and diversification strategies they would have followed in an environment of business freedom, resulting in distorted portfolios. The liberalisation has very significantly transformed the environment. The grant of more autonomy to the Navarathnas has provided them with considerable leeway for charting out their future growth.
6. **Competitive Environment:** The competitive environment too has its influence on the portfolio strategy of many companies. When competition is absent or limited, as in a protected market, even firms which are inefficient may be able to thrive. The protection itself may prompt firms to enter such business.

However, as the market becomes competitive, as has been happening in India because of the liberalisation, things may undergo drastic changes. Many firms which survived or flourished in the protected regime would not be able to survive the competition. Further, for various reasons mentioned under the Case for Focusing, it would become necessary to focus on the core business.

7. **Company Resources:** The resources and strengths of the company, undoubtedly, are important factors influencing the 'portfolio strategy'.
8. **Supply/Demand Conditions:** Problems with input supplies may encourage backward integration. Similarly, problems with marketing the output, or advantages of value addition, may encourage forward integration. When products or services can be obtained cheaply/ more efficiently from outside, it may encourage the dropping of such business and dependence on outside sources.
9. **Competitive Moves:** Some firms have a tendency to imitate the growth pattern of the established popular firms. There are firms which follow almost the same portfolio strategies of competitors. Sometimes firm A enters an important business of firm B, the latter may retaliate by entering the business of the former. There are also cases of firms refraining from certain business for fear of such retaliations.
10. **Portfolio Strategy of Parent:** The portfolio strategy of subsidiaries may be influenced by the portfolio strategy of the parent as has been the case with companies like Glaxo India, ICI and Hindustan Lever.
11. **Business Environment:** The business environment, in general, is an influencer of the portfolio strategy and, quite obviously, significant changes in business environment have important implications for portfolio strategy.

9.4 BCG MTRICES

Boston Matrix:

The Boston Consulting Group (BCG)'s matrix analyses 'products and businesses by market share and market growth.'

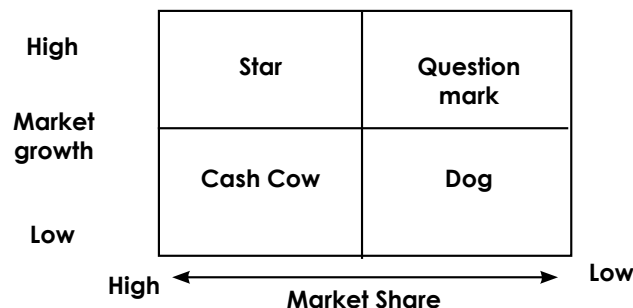

This growth/share matrix for the classification of products into cash cows, dogs, rising stars and question marks is known as the Boston classification for product-market strategy.

- (i) Stars are products with a high share of a high growth market. In the short term, these require capital expenditure, in excess of the cash they generate, in order to maintain their market position, but promise high returns in the future.
- (ii) In due course, however, stars will become cash cows, with a high share of a low-growth market. Cash cows need very little capital expenditure and generate high levels of cash income. The important strategic feature of cash cows is that they are already generating high cash returns, which can be used to finance the stars.
- (iii) Question marks are products in a high-growth market, but where they have a low market share. A decision needs to be taken about whether the products justify considerable capital expenditure in the hope of increasing their market share, or whether they should be allowed to 'die' quietly as they are squeezed out of the expanding market by rival products. Because considerable expenditure would be needed to turn a question mark into a star by building up market share, question marks will usually be poor cash generators and show a negative cash flow.
- (iv) Dogs are products with a low share of a low growth market. They may be ex-cash cows that have now fallen on hard times. Dogs should be allowed to die, or should be killed off. Although they will show only a modest net cash outflow, or even a modest net cash inflow, they are 'cash traps' which tie up funds and provide a poor return, on investment, and not enough to achieve the organisation's target rate of return.

There are also infants (i.e. products in an early stage of development) and warhorses (i.e. products that have been cash cows in the past, and are still making good sales and earning good profits even now). The car industry provides interesting examples to fit the BCG matrix. Ford, with the Fiesta, Escort and to a lesser extent, the Sierra has had a range of stars, which cost a substantial amount to develop and launch, but which soon became cash cows. Vauxhall invested heavily in the Cavalier, with great success, and here we see an example of a question mark turning into a star and then a cash cow, and the Cavalier has been at the forefront of Vauxhall's return to marketing success.

Limitations of the BCG Model:

The BCG model analyses products in the light of two variables: the growth in the market as a whole, and the growth of the product's share of the market in relation to other products. It suggests that there is a relationship between these variables and the product's propensity to generate cash or consume it. It rests on the assumption that the firm with the highest market share can be the lowest cost producer. The model suggests that cash cows should be used to fund stars. There are a number of limitations to the model (and remember that it is only a model, and any model necessarily simplifies the real world which it tries to depict).

- (i) How do you define your market? Segmentation strategies can provide a niche. A niche is inevitably a low or restricted share of the market, yet it is the heart of a focus strategy. Firms can profit servicing small low-growth niches.

- (ii) Market growth and market share are assumed to be reliable pointers for cash flow. This is often not true. High market share does not necessarily mean high profits, especially if a firm has high costs, or has bought market share by low pricing.
- (iii) Relative market share amongst competitors is not necessarily an indication of their competitive strengths at any particular time. After all, market leaders are vulnerable.
- (iv) The BCG model might become a self-fulfilling prophecy: Dogs which could be made profitable might simply be left to the rather than be resuscitated.
- (v) It does not suggest any response to declining markets other than withdrawal: many firms can make money in 'sunset industries'.
- (vi) It ignores the extent to which a firm which serves a number of markets can exploit production synergies.
- (vii) It ignores the threat of substitute products.

The product life cycle concept can be added to a market share/market growth classification of products, as in Fig. below:

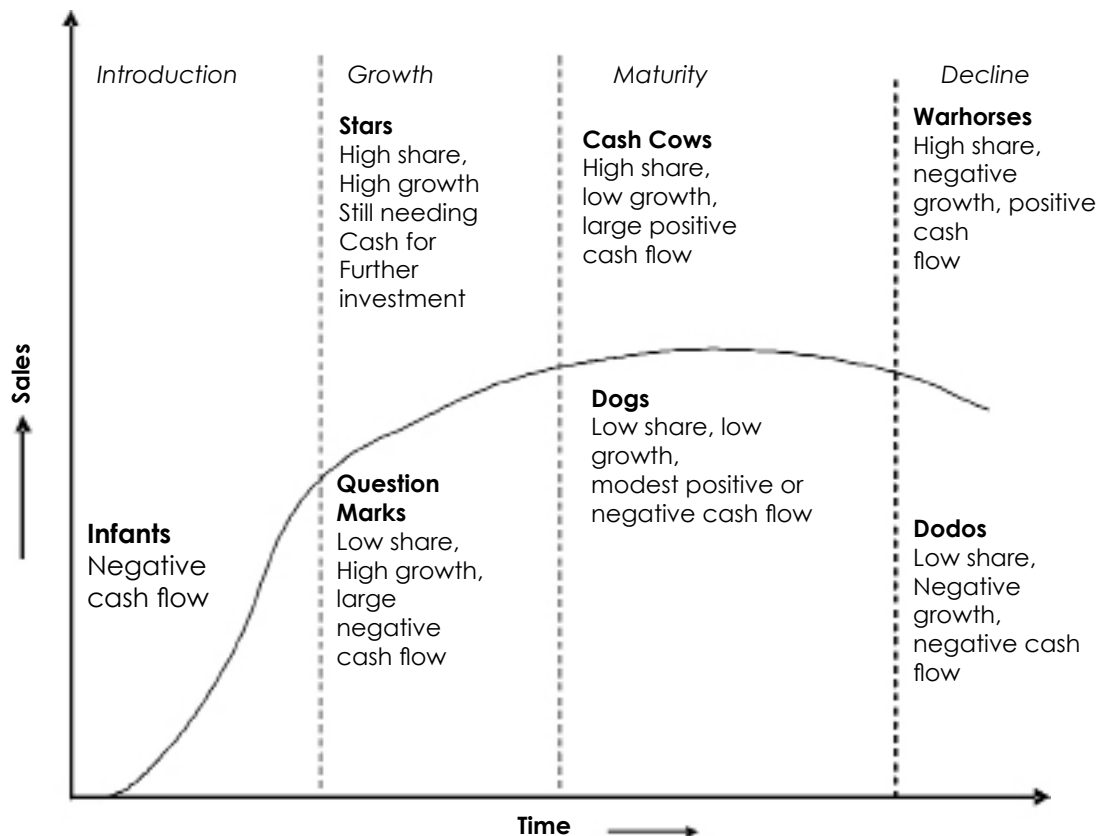

Product Life Cycle with market share/market growth classification

These matrices straightaway focus attention on the strategies most logical for investments in the four quadrants. Thus for stars, the logical strategy both from a long-term perspective as also for immediate business reasons, should be preferably to increase market share or at least to hold on to existing market share. For cash cows, in view of market growth, any attempt to increase market share, particularly, if it requires very substantial investment and

cash outgo, is hardly a logical strategy. Over the years, these investments do not have very substantial growth prospects. The logical strategy, is therefore, to hold on to the market share and harvest as much cash as possible in the form of retained profit. For dogs, four strategies are feasible: invest to increase the market share and get into the question mark category; harvest; divest; invest to get into the cash cow category. For a question mark, two possible strategies exist: elevate itself into the star category; disinvest. It will thus be seen that the logical progression of an investment should be anticlockwise, as shown in next Fig. Any progression in the opposite direction would be indicative of bad strategic management.

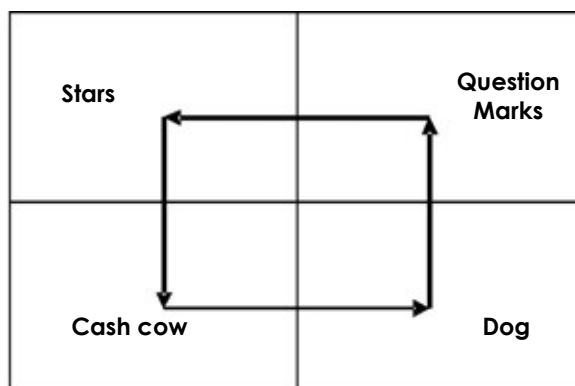

Fig.: Logical Progression of Investment

In order to dominate a market, a company must normally gain that dominance when the market is in the growth stage of the product life cycle. In a state of maturity, a market is likely to be stable with customer loyalties fairly fixed. It is therefore, more difficult to gain share. But if all companies in the growth stage attempt to gain market share, competition will be very fierce, therefore only those companies prepared to invest in order to gain share will achieve dominance. This may well suggest that a company following the principles suggested by the BCG will need to price low and spend high amounts on advertising and selling in order to dominate such a strategy is one of high risk unless such low margin activity is financed by higher profit earning products. This leads to the idea of a product wise balanced BCG model for the growth share matrix as a tool for product portfolio analysis.

The matrix combines market growth rate and market share and thus directly related to the experience curve. Thus for a star, the high volume is likely to yield the benefits of the experience curve and a reduction in cost. This benefit would not be available in case of question mark. In the case of cash cow again, the high volume would lead to the benefits of the experience curve yielding higher potential profit. Dogs are the worst of all combinations. They are often a cash drain and use up a disproportionate share of management time and resources. The implications for the analysis and evaluation of strategy are thus easy to see.

ANSOFF'S MODEL

The Ansoff Matrix:

Ansoff (1965) demonstrates the choices of strategic direction open to a firm in the form of a matrix (Figure).

Figure: The Ansoff product-market scope matrix (adapted from Ansoff, 1965)

**Market Penetration Strategy:**

		Products	
		Existing	New
Markets	Existing	Market penetration	Product development
	New	Market development	Diversification <ul style="list-style-type: none">➤ Related➤ unrelated

Firm increases its sales in its present line of business. This can be accomplished by:

- (i) price reductions;
- (ii) increases in promotional and distribution support;
- (iii) acquisition of a rival in the same market;
- (iv) modest product refinements.

These strategies involve increasing the firm's investment in a product/market and so are generally only used in markets which are growing, and hence the investment may be recouped. In this respect the strategy is similar to invest to build and holding strategy as described by the Boston Consulting Group.

Product Development Strategy:

This involves extending the product range available to the firm's existing markets. These products may be obtained by:

- (i) investment in the research and development of additional products;
- (ii) acquisition of rights to produce someone else's product;
- (iii) buying-in the product and 'badging' it;
- (iv) joint development with owners of another product who need access to the firm's distribution channels or brands.

The critical factor to the success of this strategy is the profitability of the customer group for which the products are being developed. Also the firm's present competitive advantages in serving the market must confer on to the new good. These can include:

- (i) customer information that allows accurate targeting;
- (ii) established distribution channels;
- (iii) a brand which can be credibly applied to the new product.

Market Development Strategies:

Here the firm develops through finding another group of buyers for its products.



Examples include:

- (i) different customer segments - for example, introducing younger people to goods previously purchased mainly by adults;
- (ii) industrial buyers for a good that was previously sold only to households;
- (iii) new areas or regions of the country;
- (iv) foreign markets.

This strategy is more likely to be successful where:

- (i) the firm has a unique product technology it can leverage in the new market;
- (ii) it benefits from economies of scale if it increases output;
- (iii) the new market is not too different from the one it has experience of;
- (iv) the buyers in the market are intrinsically profitable.

Diversification Strategies:

Here the firm is becoming involved in an entirely new industry, or a different stage in the value chain of its present industry. Ansoff distinguishes several forms of diversification:

1. Related Diversification:

Here there is some relationship, and therefore potential synergy, between the firms existing business and the new product/market space:

- (a) Concentric diversification means that there is a technological similarity between the industries which means that the firm is able to leverage its technical know-how to gain some advantage.
- (b) Vertical integration means that the firm is moving along the value system of its existing industry towards its customers (forward vertical integration) or towards its suppliers (backward vertical integration). The benefits of this are assumed to be:
 - taking over the profit margin presently enjoyed by suppliers or distributors;
 - securing a demand for the product or a supply of key inputs;
 - better synchronisation of the value system;
 - reduction in buyer or supplier power.

However, it also means increasing the firm's investment in the industry and hence it's fixed cost base.

2. Unrelated Diversification:

This is otherwise termed conglomerate growth because the resulting corporation is a conglomerate, i.e. a collection of businesses without any relationship to one another. The strategic justifications advanced for this strategy are to:

- take advantage of poorly managed companies which can then be turned around and either run at a gain to the shareholders or sold-on at a profit;
- spread the risks of the firm across a wide range of industries;
- escape a mature or declining industry by using the positive cash flows from it to develop into new and more profitable areas of business.

ARTHUR D. LITTLE PORTFOLIO MATRIX

The ADL portfolio matrix suggested by Arthur D. Little (ADL) consists of 20 cells, identified by competitive position and its stage of industry maturity. In this matrix, the stage of industry maturity is identified in four stages viz.,



embryonic, growth, maturity and ageing. The competitive position is categorized into five classes viz., dominant, strong, favourable, tenable and weak. The purpose of the matrix is to establish the appropriateness of a particular strategy in relation to these two dimensions.

The position within the life cycle and of the company is determined in relation to eight external factors (or disciplines) of the evolutionary stage of the industry. These are:

- (a) market growth rate
- (b) growth potential
- (c) breadth of product line
- (d) number of competitors
- (e) spread of market share among the competitors
- (f) customer loyalty
- (g) entry barriers
- (h) technology

It is the balance of these factors which determines the life cycle. The competitiveness of the organization can be established by looking at the characteristics of each category. The weights must be defined to calculate the matrix position of a particular business. The matrix location of each unit can be used to formulate a natural strategy to accomplish the business goals of the firm.

Competitive position	Stage of Industry Maturity			
	Embryonic	Growth	Mature	Ageing
Dominant	<ul style="list-style-type: none"> - Startup - Fast growth - Build barriers 	<ul style="list-style-type: none"> - Fast growth - Attain cost leadership - Renew - Defend position - Act offensive 	<ul style="list-style-type: none"> - Defend position - Attain cost leadership - Renew - Fast growth - Act offensive 	<ul style="list-style-type: none"> - Defend position - Cost focus - Renew - Harvest or divest
Strong	<ul style="list-style-type: none"> - Start up - Differentiate - Fast growth 	<ul style="list-style-type: none"> - Fast growth - Renew - Differentiate - Cost focus - Act offensive 	<ul style="list-style-type: none"> - Attain cost leadership - Renew - Differentiate - Grow with industry 	<ul style="list-style-type: none"> - Find niche - Hold niche - Hang on - Grow with industry - Harvest
Favourable	<ul style="list-style-type: none"> - Start up - Differentiate - Fast growth 	<ul style="list-style-type: none"> - Differentiate - Cost focus - Catch up - Grow with industry 	<ul style="list-style-type: none"> - Harvest - Find niche - Hold niche - Hang on - Renew - Turnaround - Cost focus - Differentiation focus - Grow with industry 	<ul style="list-style-type: none"> - Harvest - Divest



Tenable	<ul style="list-style-type: none"> - Start up - Grow with industry - Cost focus - Differentiation focus 	<ul style="list-style-type: none"> - Hold niche - Find niche - Hang on - Harvest - Catch up - Turnaround - Cost focus - Differentiation focus - Grow with industry 	<ul style="list-style-type: none"> - Harvest - Turnaround - Find niche - Retrench - Hold niche 	<ul style="list-style-type: none"> - Divest - Retrench
Weak	<ul style="list-style-type: none"> - Find niche - Catch up - Grow with industry 	<ul style="list-style-type: none"> - Turnaround - Retrench - Withdraw 	<ul style="list-style-type: none"> - Withdraw - Divest 	<ul style="list-style-type: none"> - Withdraw

The competitive position of a company's SBU or product line can be classified as:

Dominant - It is comparatively a rare situation where the SBU enjoys monopoly position or very strong market ability of its products. This may be due to high level of entry barriers or protected technology leadership.

Strong - When an SBU enjoys strong competitive position, it can afford to chalk out its own strategies without too much concern for the competitors.

Favourable - In this competitive position, no firm will enjoy dominant market share and the competition will be intense. The strategy formulation much depends on the competitors moves. The market leader will have a reasonable degree of freedom. Analysis of their product portfolio and learning from them would help others while framing their own strategies.

Tenable - The tenable competitive position implies that a firm can survive through specialization and focus. These firms are vulnerable to stiff competition in the market. They can withstand with cost focus and differentiation focus strategies.

Weak - The weak firms will generally show poor performance. They can withstand with niche strategy and can become strong players in their area. The consistent weak performance may need to divest or withdraw from the product line.

9.5 STAGES IN STRATEGIC PLANNING

The stages in strategic planning are given below:

Stage I: Strategic Option Generations

At this stage, a variety of alternatives are considered, relating to the firm's product and markets, its competitors and so forth. Examples of strategies might be:

- (a) increase market share
- (b) penetration into international market
- (c) concentration on core competencies
- (d) acquisition or expansion etc.

Stage II - Strategic Options Evaluation

Each option is then examined on its merits.

- (a) does it increase existing strengths ?



- (b) does it alleviate existing weaknesses ?
- (c) is it suitable for the firm's existing position ?
- (d) is it acceptable to stakeholders ?

Stage III - Strategic Selection

It involves choosing between the alternative strategies. This process is strongly influenced by the values of the managers in selecting the strategies.

Steps in Strategic Planning

A systematic approach to formalizing strategic plans consists of the following steps:

- (i) An internal analysis that encompasses assessing company strengths and weaknesses, financial performance, people, operational limitations, corporate culture, current positioning in the market(s), the overall characterization of the condition of the company and critical issues facing by the organization.
- (ii) An external analysis that focuses on analyzing competitors, assessing market opportunities and threats, evaluating changing technology that could impact the organization, analyzing regulatory or legislative concerns, changes and trends in the market(s) the company operates in and other potential outside influences on the organization.
- (iii) Summarizing the current situation based on the information gathered and evaluated in steps one and two. This step is important to the process because it brings together relevant and critical data and information and allows members of the planning team to more easily get a feel for what opportunities and obstacles lie ahead.
- (iv) Development of a mission, vision or purpose statement. It really does not matter what it is called, but this step is important perhaps more because of the process that the team will go through to develop it than the words that eventually end up on paper. In this step, the team is starting the process of focusing the organization and its people on what the organization is all about and what is important to the organization.
- (v) Goal setting. Every organization needs goals. Again, focus is a critical element in the success of any business. This step may be the most important of all of the strategic planning steps because it establishes the framework and basis for the development of the other key elements of the plan.
- (vi) Defining objectives that support the goals. Objectives are more specific in nature and are supportive of the goal. They bring into even greater focus to the goals of the organization.
- (vii) Development of strategies. Strategies begin defining how the goals and objectives are going to be achieved.
- (viii) While not all strategic plans include tactics, a good strategic plan will include at least the key tactics thought to be important to supporting the strategies developed in step 7. Generally tactics are more fully developed and added to the plan as time goes on. Tactics are the specific tasks associated with carrying out strategies.

Approaches in Strategic Planning

It is important to operate a planning process which will not only produce realistic and potentially rewarding plans but will also secure the support of all those involved in implementing them. There are three approaches that can be adopted to strategic planning:

- (i) A top-down process, in which managers are given targets to achieve which they pass on down the line.
- (ii) A bottom-up process, in which functional and line managers in conjunction with their staff submit plans, targets and budgets for approval by higher authority.
- (iii) An iterative process, which involves both the top-down and bottom-up setting of targets. There is a to-and-from movement between different levels until agreement is reached. However, this agreement will have to be consistent with the overall mission, objectives and priorities and will have to be made within the



context of the financial resources available to the organization. The iterative approach, which involves the maximum number of people, is the one most likely to deliver worthwhile and acceptable strategic plans.

Strategic Management and Strategic Planning : Distinction

The basic difference between Strategic management and Strategic planning are as follows:

Strategic Management	Strategic Planning
1. It is focused on producing strategic results; new markets; new products; new technologies etc.	1. It is focused on making optimal strategic decisions.
2. It is management by results.	2. It is management by plans.
3. It is an organizational action process.	3. It is an analytical process.
4. It broadens focus to include psychological, sociological and political variables.	4. It is focused on business, economic and technological variables.
5. It is about choosing things to do and also about the people who will do them.	5. It is about choosing things to do.

Corporate Planning and Long-range Planning

Corporate Planning - It is concerned with determination of objectives treating the company as a whole. It develops means to achieve the company's overall objectives. The corporate plans may relate to achieve corporate objectives for short-run and/or long-run. It is an integrated systems approach considering different functions, divisions and units of the organization. Such corporate plans are framed at the corporate level by the top management.

Long-range Planning - It is a systematic and formalized process concerned with directing and controlling future operations of an enterprise towards desired objectives for periods spreading generally over 5 or more years. It provides an opportunity to management to anticipate future problems and have got more flexibility in framing the long-range plans.

Corporate planning is not synonymous with long range planning. Corporate planning is concerned with both short periods as well as long periods. The time span depends on how far ahead a company wants to forecast, depends on nature of business and depends on commitment of resources required for it. Corporate planning in an engineering firm will involve long-term considerations but it will have short-term consideration in case of textile firm. Long range planning necessarily connotes planning with a long time horizon, generally five years or more.

Corporate planning is associated with long range planning in labour intensive industries. Corporate planning is concerned with the existing products in existing markets as well as new products and new markets. Long-range planning takes care of only the existing products in existing markets.

Strategic Planning and Long-range Planning

The basic divergence between strategic planning and long-range planning lies in the difference in the assumption regarding the future environment of an organisation. In case of long-range planning current knowledge about future conditions is known with certainty that can be relied upon by executives. Accordingly, the course of action for achievement of organisational goals is drawn on the basis of this knowledge. In long range planning the future is forecasted through extrapolation of the historical growth.

On the contrary, strategic planning assumes that an organisation must be ready to respond to a dynamic environment and future environmental conditions are not known with perfect certainty. Thus, there is a need to emphasise and understand how the environment assumed is changing. Accordingly, the issue of developing courses of action in response to these changes will have to be taken up. Here, a number of alternatives are generated for several situations for the future. In case of strategic planning, the firm tries to identify opportunities, threats and trends based on which the future prospects are analysed.

This difference between long-range planning and strategic planning has been shown in the figure below :

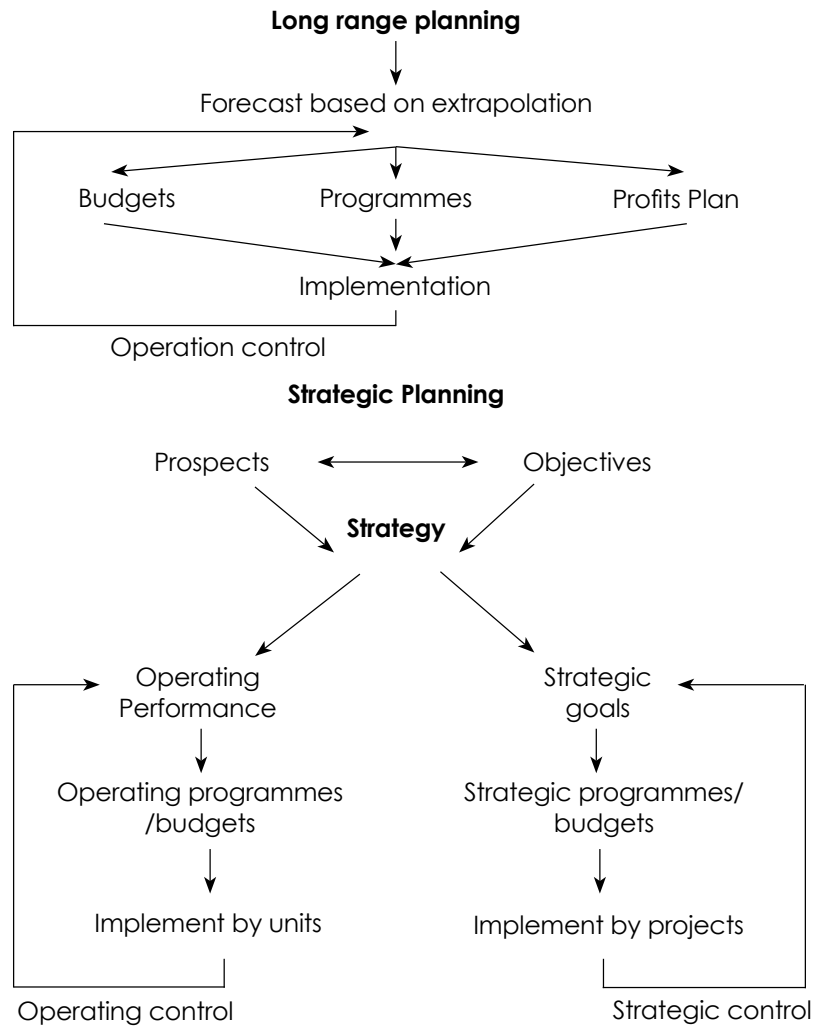

As shown in the figure above, in case of long-range planning, objectives forecasted through extrapolation are translated into budgets, programmes and profit plans. These are finally implemented. An operating control system is established and the feedback is provided which suggests a change in objectives, if required. The strategic planning leads to the setting-up of two sets of goals – operating performance goals and strategic goals. The operating performance goals are translated into operating budgets and strategic goals are translated into strategic budgets. Accordingly two types of control namely, operating control and strategic control are established.

9.6 ALTERNATIVES IN STRATEGIC PLANNING

A basic premise of good strategic management is that firms plan ways to deal with unfavorable and favorable events before they occur. Too many organizations prepare contingency plans just for unfavorable events; this is a mistake, because both minimizing threats and capitalizing on opportunities can improve a firm's competitive position.

Regardless of how carefully strategies are formulated, implemented, and evaluated, unforeseen events, such as strikes, boycotts, natural disasters, arrival of foreign competitors, and government actions, can make a strategy



obsolete. To minimize the impact of potential threats, organizations should develop contingency plans as part of their strategy-evaluation process. Contingency plans can be defined as alternative plans that can be put into effect if certain key events do not occur as expected. Only high-priority areas require the insurance of contingency plans. Strategists cannot and should not try to cover all bases by planning for all possible contingencies. But in any case, contingency plans should be as simple as possible.

Some contingency plans commonly established by firms include the following:

1. If a major competitor withdraws from particular markets as intelligence reports indicate, what actions should our firm take?
2. If our sales objectives are not reached, what actions should our firm take to avoid profit losses?
3. If demand for our new product exceeds plans, what actions should our firm take to meet the higher demand?
4. If certain disasters occur—such as loss of computer capabilities; a hostile takeover attempt; loss of patent protection; or destruction of manufacturing facilities because of earthquakes, tornadoes, or hurricanes — what actions should our firm take?
5. If a new technological advancement makes our new product obsolete sooner than expected, what actions should our firm take?

Too many organizations discard alternative strategies not selected for implementation although the work devoted to analyzing these options would render valuable information. Alternative strategies not selected for implementation can serve as contingency plans in case the strategy or strategies selected do not work. U.S. companies and governments are increasingly considering nuclear-generated electricity as the most efficient means of power generation. Many contingency plans certainly call for nuclear power rather than for coal- and gas-derived electricity.

When strategy-evaluation activities reveal the need for a major change quickly, an appropriate contingency plan can be executed in a timely way. Contingency plans can promote a strategist's ability to respond quickly to key changes in the internal and external bases of an organization's current strategy. For example, if underlying assumptions about the economy turn out to be wrong and contingency plans are ready, then managers can make appropriate changes promptly.

In some cases, external or internal conditions present unexpected opportunities. When such opportunities occur, contingency plans could allow an organization to quickly capitalize on them. Linneman and Chandran reported that contingency planning gave users, such as DuPont, Dow Chemical, Consolidated Foods, and Emerson Electric, three major benefits:

- (i) It permitted quick response to change,
- (ii) It prevented panic in crisis situations, and
- (iii) it made managers more adaptable by encouraging them to appreciate just how variable the future can be.

Steps in Contingency Planning

Robert Linnemam and Rajan Chandran have suggested that a seven step process as follows:

Step 1 - Identify the beneficial and unfavourable events that could possibly derail the strategy or strategies.

Step 2 - Specify trigger points. Calculate about when contingent events are likely to occur.

Step 3 - Assess the impact of each contingent event. Estimate the potential benefit or harm of each contingent event.

Step 4 - Develop contingency plans. Be sure that contingency plans are compatible with current strategy and are economically feasible.



Step 5 - Assess the counter impact of each contingency plan. That is, estimate how much each contingency plan will capitalize on or cancel out its associated contingent event. Doing this will quantify the potential value of each contingency plan.

Step 6 - Determine early warning signals for key contingency event. Monitor the early warning signals.

Step 7 - For contingent event with reliable early warning signals, develop advance action plans to take advantage of the available lead time.

Benefits of Contingency Planning

- (i) It will make the future through their proactive planning and advanced preparation.
- (ii) It will introduce original action by removing present difficulties.
- (iii) It enables to anticipate future problems.
- (iv) It will change the goals to suit internal and external changes.
- (v) It experiments with creative ideas and take initiative.
- (vi) It will attempt to shape the future and create a more desirable environment.
- (vii) It permits quick response to change,
- (viii) It prevents panic in crisis situations.
- (ix) It makes managers more adaptable to unforeseen changes.

9.7 PESTEL FRAMEWORK

The PESTEL framework shows some of the macro-environmental influence which might affect organisations. It focuses on the six principal components of strategic significance in the macro-environment namely, political, economic, social, technology, environmental and legal forces.

- **Political factors**

These factors include political policies and processes, including the extent to which a government intervenes in the economy. They include matters as political structure, its goals, government stability, taxation policy, foreign trade regulation, social welfare policies, political philosophy, ideological forces, political parties, centres of power, etc. Some political factors such as bailouts, are industry specific. Others, such as energy policy, affect certain types of industries (energy producers and heavy users of energy) more than others.

- **Economic Factors**

Economic conditions include the general economic climate and specific factors such as business cycles, GNP trends, interest rates, money supply, inflation, unemployment, disposable income, etc. Economic factors also include conditions in the market for stocks and bonds, which can affect consumer confidence and discretionary income.

- **Socio-cultural factors**

Socio-cultural forces include the societal values, attitudes, cultural factors, population demographics, income distribution, social mobility, lifestyle changes, attitudes to work and leisure, consumerism, levels of education, etc. Socio-cultural forces vary by locale and change over time. The socio-cultural forces primarily affects the strategic management process within the organisation in the areas of mission and objective setting and decisions related to products and markets.



- **Technological factors**

These relate to knowledge applied and the material and machines used in the production of goods and services that have an impact on the business of an organisation. Technological factors include government spending on research, government and industry focus on technological effort, new discoveries/development, transfer, rates of obsolescence, and the pace of technological change and technical developments that have the potential for wide-ranging effects on society, such as genetic engineering and nanotechnology. Technological change can encourage the birth of new industries, such as those based on nanotechnology, and disrupt others, such as the recording industry.

- **Environmental factors**

They include protection laws, waste disposal, energy consumption, weather, climate, climate change and associated factors like water shortages. These factors can directly impact industries such as insurance, farming, energy production, and tourism. They may have an indirect but substantial effect on other industries such as transportation and utilities.

- **Legal**

They include monopolies legislation, licensing, foreign investment, financing of industries, employment law, health and safety, product safety, consumer laws, antitrust laws, policies related to imports and exports, etc. Some factors such as banking regulation are industry specific. Others, such as minimum wage legislation, affect certain types of industries (low wage, labour intensive industries) more than others.

The macro – environment encompasses the broad environment context in which a company's industry is situated. Since the macroeconomic factors affect different industries in different ways and to different degrees, it is important for managers to determine which of these represent the most strategically relevant factors outside the firm's industry boundaries. By strategically relevant, it is meant important enough to have a bearing on the decisions the company ultimately makes about its long-term direction, objectives, strategy and business model. The impact of the macroeconomic variables on a company's choice of strategy can range from big to small. But even if those factors changed slowly or are likely to have a low impact on the company's business situation, they still merit a watchful eye.

9.8 PORTER'S FIVE FORCES FRAMEWORK

The five forces framework helps to identify the sources of competition in an industry or sector. When using this framework to understand competitive forces it is essential to keep in mind the following:

- (i) It must be used at the level of *strategic business units* and not at the level of whole organisation. This is because organisations are diverse in their operations and markets.
- (ii) The framework must not be used just to give a snapshot in time. It is important not just to describe these forces but also to understand how they can be countered and overcome in the future.
- (iii) These competitive forces will not only be subject to steady changes into the future but, more importantly, the discontinuities caused by changes in the macro-environment.
- (iv) The five forces are independent of each other. Pressures from one direction can trigger off changes in another in a dynamic process of shifting sources of competition.
- (v) Competitive behaviour may be concerned with disrupting these forces and not simply accommodating them.

The threat of entry

Threat of entry will depend on the extent to which there are barriers to entry. Barriers to entry are factors that need to be overcome by new entrants if they are to compete successfully. These should be seen as providing delays to entry and not as permanent barriers. The typical barriers are:



(i) **Economies of Scale**

Economies of scale arise when unit costs fall as a firm expands its output. Sources of scale economies include cost reductions gained through mass producing a standardised commodity, discounts on bulk purchases of raw material inputs and component parts, the advantages gained by spreading fixed production costs over a large production volume and the cost savings associated with spreading marketing and advertising costs over a large volume of output. If these cost advantages are significant then a new company that enters the industry and produces on a small scale suffers a significant cost disadvantage relative to established companies.

(ii) **Brand Loyalty**

Brand loyalty exists when consumers have a preference for the products of established companies. A company can create a brand loyalty through continuous advertising of its brand-name products and company name, patent protection of products, product innovation achieved through company research and development programs, an emphasis on high product quality and good after sales service.

(iii) **Absolute cost advantages**

Absolute cost advantages arise from three sources namely, (a) superior production operations and processes due to accumulated experience, patents, or secret processes, (b) control of particular inputs required for production, such as labour, materials, equipment, or management skills, that are limited in their supply; and (c) access to cheaper funds because existing companies represent lower risks than new entrants. If established companies have absolute cost advantages, the threat of entry as a component of five forces is weaker.

(iv) **Customer Switching Costs**

Switching costs arise when it cost a customer time, energy, and money to switch from the products offered by one established company to the products offered by a new entrant. When switching costs are high, customers can be locked in the product offerings of established companies, even if new entrants offer better products.

(v) **Government Regulation**

Legal restraints on competition vary from patent protection, to regulation of markets, through to direct government action. Of course, managers in the hitherto protected environments might face the pressures of competition for the first time if governments remove such protection. Historically, government regulation has constituted a major barrier into many industries.

Competitive Rivalry

Competitive rivals are organisations with similar products and services aimed at the same customer group. The competitive struggle can be fought using price, product, design, advertising and promotion spending, direct selling efforts, and after-sales service and support. More intense rivalry implies lower prices or more spending on non-price competitive weapons or both. The intensity of rivalry among established companies within an industry is largely a function of the factors such as:

- (i) The extent to which the competitors are in balance. Where the competitors are roughly equal in size, there is a danger of intense competitions as one competitor attempts to gain dominance over another. Conversely, the less competitive markets tend to be those with dominant organisations within them and the similar players have accommodated themselves in this situation.
- (ii) The level of industry demand is a second determinant of the intensity of rivalry among established companies. Growing demand from new customers or additional purchases by existing customers tend to moderate competition by providing greater scope for companies to compete for customers. Growing demand tends to reduce rivalry because all companies can sell more without taking market share away from other companies. The idea of life cycle suggests that the conditions in markets, primarily between growth stages and maturity, are important, not least in terms of competitive behaviour.



- (iii) In industries where fixed costs are high, profitability tends to be highly leveraged to sales volume and the desire to grow volume can spark intense rivalry. As capacity fill becomes a prerogative, price wars and very low margin operations are observed.
- (iv) If the addition of extra capacity is in large increments, the competitor making such an addition is likely to create at least short-term overcapacity and increased competition.
- (v) The level of differentiation plays an important role. In a commodity market, where products or services are undifferentiated, there is little to stop customers switching between competitors.
- (vi) Exit barriers are economic, strategic and emotional factors that prevent companies from leaving an industry. Where there are high exit barriers to an industry, there is again likely to be the persistence of excess capacity and, consequently, increased competition. Exit barriers might be high for variety of reasons for e.g., high fixed costs of exit, bankruptcy regulations, emotional attachments to an industry, etc.

The Bargaining Power of the Buyers

The bargaining power of the buyers refers to the ability of buyers to bargain down prices charged by companies in the industry or to raise the costs of companies in the industry by demanding better quality products and services. Buyer power is likely to be high when some of the following conditions prevail

- (i) The product or service that the industry supplies comprise a large number of small operators.
- (ii) There is a concentration of buyers, particularly if the volume purchases of the buyers are high.
- (iii) When the supply industry depends on the buyers for a large percentage of its total orders.
- (iv) There are alternative sources of supply, perhaps because the product or service requires is undifferentiated between suppliers or when the deregulation in the markets spawns new competitors.
- (v) When switching costs are low so that the buyers can play off the supplying companies against each other to force down process.
- (vi) There is a threat of backward integration by the buyer (e.g. by acquiring a supplier) if satisfactory prices or quality from suppliers cannot be obtained.

The Bargaining Power of the Suppliers

The bargaining power of the suppliers refers to the ability of suppliers to raise input prices or to raise the costs of the industry in other ways. Supplier power is likely to be high when some of the following conditions prevail

- (i) The product that the suppliers sell has few substitutes and is vital to the companies in the industry.
- (ii) There is a concentration of suppliers rather than a fragmented source of supply.
- (iii) The brand of the supplier is powerful.
- (iv) The supplier's customers are highly fragmented.
- (v) Supplier's can threaten to enter their customer's industry and use their inputs to produce products that would compete directly with those of companies already in the industry.
- (vi) Companies in the industry cannot threaten to enter their supplier's industry and make their own inputs as a tactic for lowering the price of inputs.

The Threat of Substitutes

Substitute products refer to the products of different businesses or industries that can satisfy similar customer needs. Substitution reduces demand for a particular class of products as customers watch to the alternatives. Substitution may take several forms:

- (i) There could be product for product substitution for e.g., email substitution for a postal service.
- (ii) There may be substitution of need by a new product or service, rendering an existing product or service redundant.



(iii) Generic substitution occurs where products or services compete for disposable income.

Andrew Grove, former CEO of Intel, has argued that Porter's 5 forces model ignores a sixth force: the power, vigour, and competence of complementors. Complementors are companies that sell products that add value to the products of companies in industry because when used *together*, the products better satisfy customer demands. The complementors to the personal computer industry are the companies that make software applications to run on those machines. The greater the supply of high quality software applications to run on personal computers, the greater will be the value of personal computers to customers.

The systematic analysis of the forces in the industry environment using the Porter framework is a powerful tool that helps managers to think strategically.

9.9 STRUCTURAL DRIVERS OF CHANGE

Structural Drivers of Change are forces likely to affect the structure of an industry, sector or market. The following are some of the factors

- **Increasing convergence of markets**

In some markets the customers' needs and preferences are becoming more similar. As some markets globalise, those operating in such markets become global customers and may search for suppliers. Moreover marketing policies need to be developed all over again.

- **Cost advantage of global operations**

This benefit might accrue to industries that operate in large volume, standardised production and enjoy economies of scale. In order to realise location economies businesses search globally for low cost operations and enjoying competitive edge.

- **Activities and policies of the governments**

The government policies and activities have also resulted in influencing the globalisation of industry. The moves towards free trade and technical standardisation of many products between countries have resulted in increasing competition.

- **Global competition**

It is the global competition that acts as a driver to globalisation. It may be mentioned that high level of import and export between countries increase interaction between competitors on a more global scale. The interdependence of companies across the world promotes global trade.

9.10 DIVERSIFICATION STRATEGY

Diversification strategy is a process of entering new industries, distinct from a company's core or original industry, to make new kinds of products that can be sold profitably to customers in these new industries. It takes the organisation away from its current markets or products or competences. Diversification strategy can be broadly classified into related (concentric) diversification and unrelated (conglomerate) diversification.

- (a) Related (concentric) diversification is a corporate level strategy that is based on development beyond current products and markets, but within the value system or 'industry' in which it operates. The multi business model of related diversification is based on taking advantage of strong technological, manufacturing, marketing and sales commonalities between new and existing business units that can be suitably adjusted or modified to increase the competitive advantage of one or more business units. For e.g. Johnson and Johnson engaged in research and development, manufacture and sale of various products in the health care field worldwide.
- (b) Unrelated (conglomerate) diversification is a corporate level strategy based on multi business model whose goal is to increase profitability through the use of generic organisational competences to increase



performance of all the company's business units. In other words when an organisation moves beyond its current value system or industry it is called unrelated (conglomerate) diversification. For e.g. the ITC Group is in agribusiness, FMCG, hotels, paperboards, packaging and IT.

Self Learning Questions:

1. What is the purpose of SWOT analysis? Why it is necessary to do SWOT analysis before selecting a particular strategy for a business organisation.
2. Explain the objective of SWOT analysis and its advantages and criticism.
3. SWOT analysis merely examines the internal environment of an organisation. Comment.
4. What do you mean by Portfolio Analysis and do list down its objective.
5. What are the important concepts in the context of Portfolio Analysis?
6. Explain about the BCG Matrix.
7. Hassan is one of the Indian's leading detergent manufacturing companies. The firm has more than twenty five products type. These have been developed over a period of its ten year existence. Some products are very successful while others have not performed well. The challenges for the board have been the formulation of strategy policy in the way the company manages the portfolio of products.

As a newly recruited qualified Cost Accountant, your advice is being sought to address the following questions the Products managers has prepared as input into his paper to the Board.

- (a) Describe the BCG growth sector matrix.
 - (b) Explain what strategic options are available to Hassan in accordance to the BCG Matrix.
 - (c) Outline what limitations the model poses to the Product Managers as he prepares his paper to the Board.
8. Explain the growth strategies under Ansoff Product Market Growth Matrix.
 9. Explain the ADL Matrix.
 10. Discuss the various stages in Strategic Planning.
 11. Discuss Contingency Planning and its seven steps process.





Study Note - 10

FORMULATION AND IMPLEMENTATION OF STRATEGY



This Study Note includes

- 10.1 Strategy Formulation Function-wise (Production Strategy, Marketing Strategy, Manpower Strategy)
- 10.2 Structuring of Organisation for Implementation of Strategy
- 10.3 Strategic Business Unit
- 10.4 Business Process Re-engineering
- 10.5 Core Competence and Critical Success Factors

10.1 STRATEGY FORMULATION FUNCTION-WISE

Formulation of strategy

- (i) Develop and evaluate strategic alternatives
- (ii) Select appropriate strategies for all levels in the organisation that provide relative advantage over competitors
- (iii) Match organizational strengths to environmental opportunities
- (iv) Correct weaknesses and guard against threats

Implementation of strategy

- (i) effectively fitting organizational structure and activities to the environment
- (ii) The environment dictates the chosen strategy; effective strategy implementation requires an organisational structure matched to its requirements. Evaluating results
- (iii) How effective have strategies been?
- (iv) What adjustments, if any, are necessary

Strategy formulation function wise

Strategy often require changes in the way an organization is structured for two major reasons:

1. Structure largely dictates how objectives and policies will be established;
2. Structures dictates how resources will be allocated.

The choice of structure appears contingent on the strategy of the firm in terms of size, diversity of the products / services offered, and marked served.

Whether this is due to inertia, organizational politics, or a realistic assessment of the relative costs of immediate structural change, historical evidence suggests that the existing structure will be maintained and not radically redesigned until a strategy's profitability is increasingly disproportionate with increasing sales.

PRODUCTION STRATEGY

Need for a Production Strategy:

The key to successful survival of an enterprise as an independent unit is how efficiently production activity is managed. The two major factors that contribute to business failures are obsolescence of the product line and excessive production costs. These factors themselves have been the outcome of ineffective production planning.

Production strategy plays crucial role in shaping the ultimate success of a firm. Being based on objective analysis of external environmental forces and corporate strengths and weaknesses, it enables an organisation to make optimal decisions regarding product, production capacity, and plant location, choice of machine and equipment



and maintenance of existing facilities. Constant review of manufacturing plan aids in maintaining proper balance of capital investment in plant, equipment and inventory, personnel commitment, efficient operation of the production system by bringing in flexibility and versatility in response to schedule fluctuations, product mix and variations in raw material and quality control, and ensures effective material handling and planning of facilities.

Within the corporate structure, production strategy helps in maintaining full co-ordination with marketing and engineering functions to formulate plans to improve products and services. It calls upon management to keep in constant touch with finance and personnel to achieve the optimal use of assets, cost control, recruitment of suitable production personnel and management of labour disputes and negotiations.

Formulating Production Strategy:

The following steps are involved in the formulation of production strategy—

- (i) Study the overall corporate plan and define the objectives.
- (ii) Analyse the present production operations and the present and future environment.
- (iii) Review sales- forecast and marketing.
- (iv) Make strategic decisions for production.

1. Study of Corporate Plan and Statement of Objectives: As in other operating areas, production planning begins with corporate objectives and planning premises. Examination of overall corporate planning not only provides overall directions for manufacturing but also answers questions about overall economic, industrial, market and company factors which will limit and otherwise affect the production planning. Within the framework of these overall planning factors, the planner establishes production objectives and definitions of the general product and process areas in which production operations should concentrate.

2. Analysis of the Present Production Operations and the Environmental Forces: The production manager should analyse the current manufacturing operations and the present and future environmental trends to determine the company's manufacturing strengths and weaknesses and to isolate environmental factors such as the manpower supply and new process and equipment developments, which significantly affect manufacturing operations. During this phase of manufacturing planning, the planner examines the premises or factors that affect the manufacturing operations specifically.

A study of plant location should be made to assess the effectiveness of present location with respect to key supplies and channels of distribution, and analyse the economies of plant location in terms of labour costs and reservoir of labour skills, both short-term and long-term. Percentage of plant capacity being currently used effectively should also be studied.

The existing condition of the machinery should be studied and its quality and efficiency should be compared with others in the same field including overseas competitors. It must also be ascertained as to how many new equipment developments within the industry have been used by the company such as use of computers for scheduling, automated warehouses, miniaturisation, programmed equipment, etc. Current schedule for replacement of machinery and cost of such replacement also need examination.

Regarding maintenance, production manager should check availability of replacement parts. He should also see if the company has work standards to measure productivity.

In production scheduling, information regarding down time on machinery, accuracy of scheduling, history of production delays and reasons for the delays, method changes over the past few years and future trends, etc. should be gathered and analysed.

Regarding materials aspect of production it is very necessary to analyse the purchasing requirements, rate of inventory turnover, production delays due to out of stock materials, condition of the material handling equipment, adequacy of existing facilities of the material handling equipment, adequacy of existing facilities for storing and warehousing materials and other similar matters.

3. Review of Sales Forecast and Marketing Mix: Since planning in other areas affects manufacturing plans, the planner should examine the plans in these areas. Sales goals are the basis upon which specific operating



plans for manufacturing are built. Hopefully, the manufacturing manager will have participated in the development of these goals so that the sales goals can be reconciled with operations limitations. Once settled manufacturing plans can be developed to meet sales goals. The impact of marketing mix, research and development and new product administration on manufacturing are also examined.

- 4. Making Strategic Decisions:** Keeping in mind the overall corporate business mix, present production operations, environmental forces, sales forecast and marketing mix, the production manager has to decide about the extent of manufacturing activity, choice of manufacturing process, capacity machines and equipment to be used, and physical facilities.

(a) Extent of Production Activity: The first vital decision which a production manager has to make, particularly in consultation with marketing and finance managers, is regarding the extent of manufacturing activity the firm will carry out. There is usually a great deal of choice in the extent of commitment to production, i.e., of vertical integration. At one end of the spectrum are all the items used in production including standard parts, small special components and major components that can be manufactured and completely assembled. At the other end are the finished products that can be bought and the company's name attached. Nature of the manufacturing operation dictates, to a certain extent, the area where the optimum is likely to be. Even then, there is often a considerable range of variation.

A number of factors influence managerial decision regarding extent of manufacturing activity. A firm will be tempted to manufacture raw materials and components for the products to be sold along with assembling parts, if it finds that this will ensure supplies in accordance with their required quality, quantity and timely availability.

This temptation will be further strengthened when costs of producing raw materials and components are found to be less than the price at which suppliers will supply these materials. Uncertainty regarding ready availability of supplies further suggests that the firm should have a captive source of supply of vital raw materials and ingredients.

Size of investment involved in developing production facilities also influences the extent of the firm's production activity. Where the investment involved is large, introducing new products or changing the product design with consequential charges in the plant facilities are likely to be too costly to bear. In such situations it will be desirable for the firm to procure its materials from outside sources because that provides greater flexibility and adjustment to changes in needs.

Financial strength of the firm plays a significant role in deciding the extent of the production activity of the firm. Thus, a firm with a strong financial position is better placed in integrating manufacturing and processing of components and products than the one whose financial position is weak.

Similarly, availability of managerial expertise in the firm decides the range of manufacturing activity. Where a firm has executives with specialised skill and competence in a particular line of activity, it must recruit new executives with equal efficiency. It will, therefore, be prudent on the part of the production manager to consult the top management if the firm can afford the cost of new executives. The finance manager may also be involved in working out the cost-benefit implications of the decision.

- (b) Choice of Manufacturing Process:** Selection of a suitable process in advance of the actual production of goods is another strategic decision that considerably influences the success of an industrial enterprise. The design of the manufacturing process is not restricted to new concerns or new products. Existing enterprises have also to review their operations in the light of the competition in order to increase production at lower costs.

Production process refers to the design of a series of operations to transform inputs into desired outputs. Process planning involves the following steps:

1. A-careful review of the product design and specifications to make sure that economic manufacture is feasible.
2. Determination of the methods of manufacture that will result in the optimum manufacturing cost.



3. Selection or development and procurement of all machines, tools, and other equipment required for the manufacture of the product at the required quality and rate of production.
4. Layout of the production area and auxiliary spaces and installation of the manufacturing facilities.
5. Planning for and establishing the necessary control of materials, machines and manpower to ensure the effective utilisation of the manufacturing facilities for economical production of the product.

Thus, the process design activity comprises all such activities as are necessary to arrange for the manufacture of the product by the most economical means and in compliance with all safety regulations.

- (c) Capacity Decisions:** While considering a new plant design or the redesign or expansion of an existing system, a high level decision regarding the production capacity is called for. In order to determine future capacity of the plant adequate consideration should be given to certain factors such as sales forecasts of physical volume, policy decisions on what will be purchased instead of made, engineering estimates of machine productivity and production plans on how equipment will be used. Upon this must be super imposed central management policies regarding desired capacity including policies regarding provisions for peak versus normal requirements, backward taper of capacity provision for growth and balance of facilities.

One of the most vital decisions which have to be made regarding production capacity is whether the company should build so much capacity to satisfy all demands during peak periods or whether it should maintain a smaller capacity and hope that failure to render service during requirements will not have unbearable consequences. Generally, companies providing utilities have a policy of building capacity to cope with peak demands (during hot summer days). But the investment made for peak demands is tremendous.

In view of burgeoning amount of investment the moot question that arises is whether capacity installed in order to meet the maximum expected demand should be maintained at all times. It may not be disadvantageous to maintain the excess capacity throughout the year if one is confident that excess capacity can be utilised by expanding exports or by accumulating stocks if the duration of the surplus capacity is expected to be limited.

There are some organisations who prefer to build smaller capacity to take care of normal requirements and meet peak demands by way of imports or subcontracting — some organisations employ measures such as off-peak discounts, mail early campaign, etc. to induce customers to avoid peak periods.

Another way of meeting high peak demands is to switch over to two shifts from the single shift. Before making a final decision in this direction, cost-benefits analysis must be undertaken. With doubling of shifts, investment costs are not halved because increments of capacity are not equally expensive. Many other costs are also involved. Wage premiums say 10 to 15 per cent, are generally given for second shifts. Multiple shifts also increase supervision costs. An analysis of building and equipment costs resulting from doubled shifts is necessary to determine the total additional cost. Additional cost should be matched with additional benefits. Where benefit exceeds costs it will be in the interest of the organisations to run double shifts to cope with peak demands.

Adequate provision for coping with growth requirements of the organisation must be made while determining production capacity. For this, it is necessary for the top management to decide how much growth is expected and the extent to which investment will be made in anticipation of growth. This decision will have to be taken very carefully otherwise it may result in too much or too little capacity in serious consequences.

- (d) Choosing Machines and Equipment:** Another strategic decision to be made by a production manager is what type of equipments the organisation will require for production purposes, how much it will cost, what will be its operating cost and what services it will render to the organisation and for how long.

Choice of equipment for making a particular product essentially depends on the basic manufacturing process. The decision maker must, therefore, familiarise himself with the production process to be adopted.

Another consideration in the choice of new equipment for a plant is the type and degree of operating skill required and presently available skills within the organisation. Other factors worth consideration are the ease with which the equipment, can be operated and the safety features of the equipment.



While deciding about the number of each type of machines needed to produce a product, producing engineer must take into account the quality of product to be made within any given period of time, number of working hours in the plant during this period, the various production rates on the operations to be performed, set-up time for each operation, number of set-ups per machine for the time period, the operating efficiency of the plant and finally the scrap loss during each operation. To find the requirements for any particular piece of equipment in a process, the total number of hours per month (or other time period) that the equipment is required to produce the desired quantity is divided by the total number of hours per month that the equipment is available, taking plant efficiency into consideration. Then the total requirements for all operations to be performed on each unit of equipment are considered in terms of the number of set-ups involved and the time required for each set-up.

In a product-line layout of equipment, where each machine is set up to perform only one operation, the set-up time can be neglected, but the problem of line balancing becomes important. In the process-type layout, where machines are commonly used on several different parts and/or operations, set up and scheduling time losses must be carefully considered. Balancing is not a serious problem in such case.

For balancing the capacities of various machines in a product-line layout, it may be desirable to buy more than enough machines if the equipment is not very expensive and if this will avoid possible shut-down or restriction of the entire manufacturing line. Where the equipment is quite costly, it may be necessary to provide only the minimum number of machines and rely upon overtime or extra-shifts to meet production requirements when breakdowns occur.

- (e) Equipment Investment:** Acquisition of equipment involves capital expenditure which will have long-term effects on the financial position of the company. Hence, before taking a final decision regarding investment in a machine, detailed analysis of such investment in terms of cost-benefits must be made and its desirability and worthwhile ness should be evaluated with the help of internal rate of return or present value method.

The decision to replace the existing machine is equally important to the enterprise. In this regard the management has to decide when the replacement should be made and what is the best replacement policy which must be considered while making comparisons between an existing unit of equipment and its possible replacement. In order to make a sound economic comparison, all the factors must be converted into cost considerations. Then, cost savings resulting from the proposed equipment must be related to incremental capital expenditure reducing the former in present value. The rate of return so obtained is compared with the cut-off rate to ascertain whether the replacement is economically viable.

Thus, clear-cut policy guidelines regarding methodology or computation of net investment outlay, incremental operating expenditure and income depreciation, obsolescence, salvage value etc. will help management in taking decisions regarding acquisition and/or replacement of machines.

- (f) Physical Facilities Decisions:** Facilities strategy covers plans for location analysis and selection, design and specifications including layouts of equipment, plant, warehouses and related services specifying and providing for maintenance. Facilities planning deals with the separate but interrelated costs of material, supplies, manpower services and facilities. Its mission is to find ways to minimise the aggregate of such costs in making and distributing the products at the proper time.

Plant Location: Plant location is essentially an investment decision having long-term significance and implied economic effects. A good decision plays off; a bad decision can cause grim financial difficulties. Once a plant is acquired, it is a permanent site that cannot readily be sold. The management may also contemplate relocation of the plant when business expansion and advanced technology require additional facilities to serve new market areas, to produce new products, or simply to replace the old, obsolete plants to increase the company's production capacity.

Before a location for a plant is sought, long range forecasts should be made anticipating the future needs of the company. These should be based on the company's expansion policy, the anticipated diversification of products, the trends in market demand, geographical distribution, material and labour supply, and any other foreseeable influences. Thus, plant location decisions require intensive study of economic and socio-political circumstances.



The accuracy of forecasting is essential regarding rising demand and anticipated sales increases. Miscalculation in this respect may post serious problems before the company can occupy the new facilities once built and expand the new facilities subsequently due to land and environmental constraints.

The selection of an appropriate plant site calls for location study of the region in which the factory is to be situated, the community in which it should be placed and finally, the exact site in the city or countryside.

Plant Building: Once the company has chosen the plant site, due consideration must be given to providing physical facilities. A company requiring extensive space will always construct new buildings.

Oil planning a building for the manufacturing facilities, a number of factors will have to be kept in mind such as nature of the manufacturing process, plant layout and space requirements, lighting, heading, ventilating, air-conditioning, service facilities and future expansion.

Plant Layout: Plant layout involves the arrangement and location of production machinery, work centres and auxiliary facilities and activities (inspection, handling of material storage and shipping) for the purpose of achieving efficiency in manufacturing products or supplying consumer services. Plant layout should co-ordinate use of material, men and machines and achieve the following objectives:

- Facilitate the manufacturing process,
- Minimise materials handling,
- Maintain flexibility of arrangement and operation,
- Maintain high turnover of work-in-process,
- Hold down investment in equipment,
- Make economical use of building cube,
- Promote effective utilisation of manpower,
- Promote for employee convenience, safety and comfort in doing the work.

In designing plant layout a number of factors such as nature of product, volume of production, quality, equipment, type of manufacture, building plant site personnel and materials handling plan should be kept in view.

Maintenance of Equipment: Maintenance of equipment is an important facility of planning consideration. It is intimately linked with replacement policies. Every manufacturing enterprise follows some maintenance routine in order to avoid unexpected breakdowns and thus minimise costs associated with machine breakdowns such as machine down time and possible loss of potential sales, idle direct and indirect labour, delays in other processes that may depend for material supply on the machine that is down, increased scrap, customer dissatisfaction from possible delays in deliveries and the actual cost of repairing the machine.

A number of strategies can be adopted for maintenance of machines and equipment. Two most important ones are carrying excess capacity and preventive maintenance.

In carrying excess capacity method an organisation carries stand-by capacity which is thrown into the breach if trouble occurs. This excess capacity can be whole machines or it can be major parts or components which ordinarily take time to obtain. Carrying excess capacity involves cost which must be compared with costs arising out of a slow-down or a shut-down of a whole series of dependent operations. Therefore, the decision in this regard is cost trade-offs.

The question that now arises is how much excess capacity should be carried by an organisation. This should be decided keeping in mind a fundamental principle that as the number of stand-bys increases, lost production costs decrease while holding costs for the stand-bys rise. The alternative providing the minimum total cost is preferred.

Preventive Maintenance: Preventive maintenance is based on the premise that good maintenance prevents breakdowns. Preventive maintenance means preventing break downs by replacing worn-out machines or their parts before their breakdown. It anticipates likely difficulties and does the expected needed repairs at a convenient time before the repairs are actually needed. Preventive maintenance depends upon the past knowledge that certain wearing parts will need replacement after a normal interval of use.



Another and quite different kind of preventive maintenance can better be called maintenance prevention. It is concerned with designing machines which will be both trouble-free and easily repaired.

The most strategic decision which a production manager has to make in this regard is to determine whether preventive maintenance is more expensive than repairing on call. This requires comparison of total costs involved in preventive maintenance with those in repairing. There are more elaborate models for special maintenance problems such as an inspection policy for equipment that can be restored to an operating condition and replacement and policy for equipment renewed after a certain length of service. However, such sophisticated analyses are appropriate when the investment involved is large or service reliability is critical.

A typical preventive maintenance strategy is more mundane than mathematical modelling. The guiding principle is that the time spent on preventive maintenance should be less than the time required for repairs, and the value imported to machines by preventive maintenance should exceed the programme cost.

MARKETING STRATEGY

MARKET:

Market is an arrangement that provides an opportunity of exchange of goods and services, for money or money's worth. It is the means to settle the terms of exchange.

Marketing:

Some important definitions of marketing are:

"Marketing is the performance of business activities that direct the flow of goods and services from producer to consumer or user."

Another definition of marketing "is getting the right goods and services to the right people at the right place, at the right time, at the right price, with right communication and promotion."

Marketing is "a social process by which individuals and groups obtain what they need and what through creating and exchanging products and value with others."

Marketing is, "the management function which organises and directs all those business activities involved in assessing and converting customer purchasing power into effective demand for a specific product or service and in moving the product or service to the final consumer or user so as to achieve the profit target or other objectives set by company.

Marketing is the process of exchange involving two distinct aspects namely, mental and physical. In a macro sense, it is a system that directs an economy's flow of goods and services to consumers and accomplished society's objectives. In a micro sense, it is the process of finding out what people need; helping to develop need satisfiers, informing and persuading, moving properly priced products and services to consumers and keeping the consumers satisfied.

Role of Marketing:

The first and foremost role is that it stimulates potential aggregate demand and thus enlarges the size of the market. You might ask how it helps in the economic growth of a country. The answer is that through stimulation of demand people are motivated to work harder and earn additional money to buy the various ideas, goods and services being marketed. An additional advantage which accrues in the above context is that it accelerates the process. (In India, it is believed that about one-fourth of GNP and more than one-third of agricultural output are still non-monetised).

Another important role which marketing plays is that it helps in the discovery of entrepreneurial talent. Peter Drucker, a celebrated writer in the field of management, makes this point very succinctly when he observes that marketing is a multiplier of managers and entrepreneurs.

Still another important contribution which marketing makes is that it helps in sustaining and improving the existing levels of employment.



Marketing Functions:

Marketing involves eight important functions: Buying, Selling, Storage, Transportation, Financing, Standardisation, Grading and Risk-Taking.

Marketing Environment:

It is the sum-total of external factors within which the enterprise operates. It is the compendium of forces external in nature like social, economic, ethical, political, physical and technological. These are uncontrollable external forces that provide opportunities and challenges to the firm.

Universal Functions of Marketing:

Universal functions of marketing consist of buying, selling, transporting, storing, standardisation and grading, financing, risk-taking and market information.

Marketing Objectives:

- (i) Creating awareness and appreciation of the crucial role of consumer in shaping decisions, and of the profit as a basic foundation of corporate existence, stability and growth.
- (ii) Awareness that consumers can only be helped to solve their problems through corporate efforts.
- (iii) Awareness and concern with trans-departmental implications of an individual department's decisions and actions and their effect on the firm's equilibrium with its external environment— consumers, competitors, government, etc.
- (iv) Concern with, and interest in, the innovation of products and services so as to solve select consumer problems.
- (v) Concern with the effect of new product and service introduction on firm's present and potential profit position.
- (vi) Sensing and monitoring information as regards market potential to serve as a base for goal and target setting.
- (vii) Focus in coordinating company effort and in establishing corporate and departmental objectives consistent with the enhancement of the firm's profit position.
- (viii) Awareness and appreciation of the role of formal, periodic, short and long-range planning of company's goals, strategies and tactics resulting in an integrated system of marketing actions.
- (ix) Desire and preparedness for the creation, expansion, contraction, termination, or in any way, restructuring of any corporate function in order to mobilize, utilize and control corporate effort.

Marketing Plan:

Marketing plan is a written document that specifies in detail the firms marketing objectives and how marketing management will use the controllable marketing tools such as product design, channels, promotion and pricing to achieve these objectives.

Marketing strategy means finding attractive opportunities and developing profitable ways to capture the market. A marketing strategy specifies a target market and a related marketing mix. It is a big picture of what a firm will do in some market. The job of planning strategies to guide a whole company is called strategic planning. It is the managerial process of developing and maintaining a match between an organisation's resources and its market opportunities.

The Marketing Concept and the Selling Concept:

The marketing concept is a business philosophy that challenges previous concepts. The marketing concept holds that the key to achieve organisational goals consists in determining the needs and wants of target markets and delivering the desired satisfactions more effectively and efficiently than competitors. The marketing concept has been expressed in many colourful ways:

- (i) meeting needs profitably



- (ii) find wants and fill them
- (iii) love the customer, not the product
- (iv) have it your way
- (v) you're the boss
- (vi) to do all in our power to pack the customer's rupee full of value, quality and satisfaction.

The marketing concept rests on four main pillars, namely target market, customer needs, coordinated marketing and profitability. These are shown in the figure below, where they are constructed with a selling orientation. The selling concept takes an inside-out perspective.

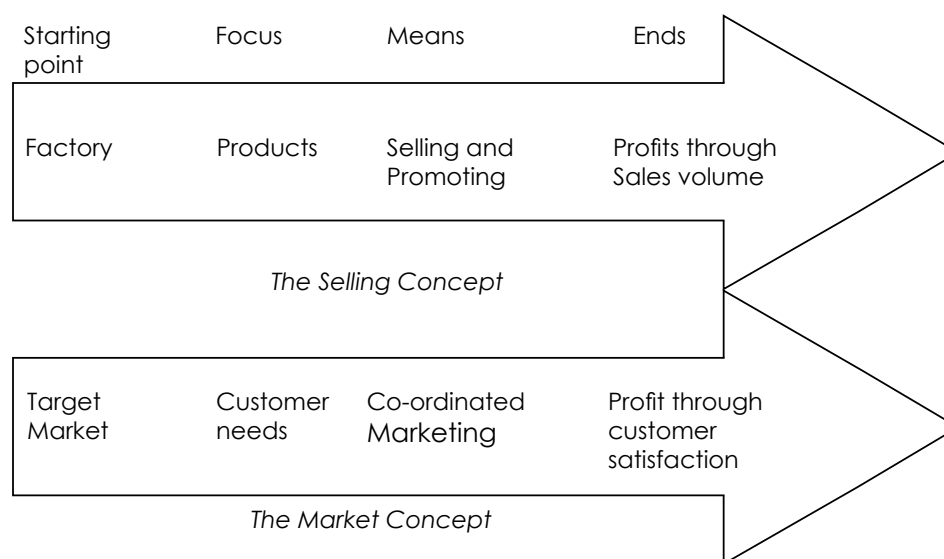

The selling and marketing concepts contrasted

It starts with the factory, focuses on the company's existing products, and calls for heavy selling and promoting to produce profitable sales. The marketing concept takes an outside-in perspective. It starts with a well-defined market, focuses on customer needs, co-ordinates all the activities that will affect customers and produces profit through customer satisfaction.

Most companies do not really grasp or embrace the marketing concept until driven to it by circumstances. Any of the following developments might produce them:

- (i) sales decline
- (ii) slow growth
- (iii) changing buying patterns
- (iv) increasing competition
- (v) increasing marketing expenditure.

In the course of converting to a market oriented company, a company will face three hurdles—organised resistance, slow learning and fast forgetting. But, since the marketing concept is concerned with how the business conduct itself, the application of the marketing concept to management decisions should begin at the strategic planning stage, and continue through product development and testing to its eventual sale in the market, and after sales services, in other words, throughout the value chain.

Social Marketing:

Societal marketing concept calls for a customer orientation backed by integrated marketing aimed at generating customer satisfaction and long-run consumer welfare as the key to attaining long-run profitable volume.



The importance of developing a market orientation in Strategic Planning:

The marketing concept is the most practical philosophy for achieving any commercial organisation's objective such as growth in profits.

- (i) By applying the marketing concept to product design etc. the company might hope to make more attractive products, hence to achieve sustained sales growth and so make higher profits.
- (ii) The importance, to some firms, of building up a long-term relationship with customers. Profits do not only come from individual transactions with customers, but also from the customer's propensity to deal with the firm rather than its competitors.

The importance of developing a market orientation to strategic planning is implicit in the marketing concept.

- (i) With the product concept and selling concept, an organisation produces a good or service, and then expects to sell it. The nature of the organisation's business is determined by what it has chosen to produce, and there will be a reluctance to change over to producing something different.
- (ii) With the marketing concept, an organisation commits itself to supplying what customers need. As those needs change, so too must the goods or services which are produced. In other words, marketing orientation enables a firm to adapt to the environment.

Strategic planning involves making decisions about the choice of product-market strategies- developing new products and new markets that will fill the profit gap. A marketing orientation should help planners to identify more successfully what products or markets, by meeting perceived customer needs, would earn good profits for the organisation. Having decided on a competitive strategy and a product-market strategy portfolio and a sales growth plan, a firm must then decide on the following:

- (i) Which markets offer the opportunity for successful investment? In other words, if the strategy is diversification, which new markets should be looked at?
- (ii) From these, which target markets should be selected for development.
- (iii) How the firm should offer its product or service in comparison with the offerings of competitors.
- (iv) How to establish a marketing system and organisation for the firm.
- (v) How to develop a marketing plan and then implement and control it.

Strategic marketing is concerned with the development and implementation of marketing plans, for both the long term and short term, which should enable a firm to achieve its objectives and goals. A firm can apply this as follows:

- (i) Environmental opportunities exist anywhere in the environment, e.g. in the field of what type of goods and services. Not all environmental opportunities are appropriate to the objectives of a single firm.
- (ii) Any company is likely to have distinctive competence in one or more areas of activity which makes it more likely than other companies to be able to take advantage of a certain environmental opportunity.

Marketing Management:

Marketing management is the crucial and creative task of delivering consumer satisfaction and thereby earning, profits through consumer demand.

Marketing Strategies:

Marketing strategy is a process that can allow an organisation to concentrate its limited resources on the greatest opportunities to increase sales and achieve a sustainable competitive advantage. A marketing strategy should be centered around the key concept that customer satisfaction is the main goal.

Markets can be described and defined by their nature of competition. Basically, the company's overall marketing strategy is its competitive posture in the marketplace. The marketer's first task is to select a promising market and identify its needs and buying patterns, after which he formulates strategies for each controllable factor (product, distribution, promotion and pricing).



Management's mission is to manipulate the controllable in terms of the uncontrollable in ways that both meet the target market needs and facilitate achievement of the company's overall goals. To accomplish this, management unifies the product market, distribution, promotion and pricing strategies into an overall marketing strategy (i.e., into a deliberately planned competitive posture).

In marketing, many decisions are made—each seemingly independent, all, in fact, interrelated. Thus, if a marketer changes the product's price by a substantial amount, other parts of the company's overall marketing strategy need re-evaluation. Ultimately, marketing success depends on skill in maintaining an optimum combination of strategies, which is in keeping overall marketing strategy in balance.

In formulating and implementing overall marketing strategy, management concerns itself with identifying opportunities to serve target markets profitably and serving them so effectively that it is difficult for competitors to take business away on a profitable basis.

Competitive postures are either aggressive or defensive. When a market's products are already established in the market, there is a strong temptation to adopt a defensive posture, i.e., to maintain a holding action. The danger in defending the status-quo is that this means yielding the initiative to competitors. If the competitors develop important product innovations, they may succeed in breaking established customer loyalty and buying patterns.

The importance of formalized overall marketing strategies (i.e., deliberately planned competitive postures) varies with the competitive setting. There are four types of competitive settings.

1. No direct competition
2. Pure competition
3. Monopolistic competition
4. Oligopolistic competition

Formulating Overall Marketing Strategy:

A marketing strategy should be used as a working paper that guides the store's operations for the next 1-2 years. The format of a marketing strategy has three sections:

Basic assumptions -- based on survey results and past planning processes;

Strategic goals -- goals for growth and fiscal health of the co.

Achieving goals -- operational ideas for changes that will alter the perception of the storefront by the public to conform to the strategic goals.

Formulation of overall marketing strategy requires integration of all dimensions of marketing effort. Ideally, the marketer should have some concrete system for determining whether the combination of inputs going into the overall marketing strategy is optimal, and therefore, whether the resulting profit (and other desired outputs, in terms of the company's goals) is also optimal. The systematic approach is one requiring evaluation of possible inputs in overall marketing strategy in terms of the likely outputs. Selections are then made from the various inputs so that the combination (i.e., the overall marketing strategy) has the best chance for achieving the desired outputs.

In order to be consistently and profitably customer oriented in a continuously changing market, what is needed is a proper marketing strategy concerning target markets, marketing mix and marketing expenditure levels. Thus, a viable fit is achieved among corporate objectives, available resources, skills and opportunities.

The strategic planning process is carried out at corporate, business and product levels. Strategic planning involves repeated cycles of analysis, planning, implementation and control. The horizons of strategic plans are usually larger—usually 1-5 years. Corporate strategic planning involves four planning activities:

- (a) Developing a clear mission for the company in terms of its industry, product & competence.
- (b) Identifying the company's Strategic Business Units (SBUs) which can benefit from separate planning and be managed as separate profit centres.



- (c) Allocating resources to SBUs based on their market attractiveness and business strength, or market growth rate and Relative Market Share matrix. The two most important portfolio models are Boston Consulting Group (BCG) model and General Electric (GE) model. Careful use of the portfolio models helps in isolating SBUs to be built, maintained, harvested or divested.
- (d) Expanding present business and developing new ones to fill the strategic planning gap: The company can identify opportunities by considering intensive growth (market penetration, market development and product development), integrative growth (backward, forward and horizontal integration) and diversification (concentric, horizontal and conglomerate diversification).

SBUs determine their own business, product and services strategies considering the business mission, external and internal environment. Marketing strategy provides the context for marketing planning with a much smaller horizon, usually up to 1 year.

Manpower Strategy:

The concept of Human Resource Development (HRD) has evolved over time with the recognition of people employed in organisations as a resource. In a comprehensive sense, HRD is defined as a process by which employees are encouraged and helped in a continuous and planned way to (a) acquire and sharpen capabilities to perform functions relating to their present or future positions, (b) develop their general abilities as individuals, (c) identify and make use of their own inner potentials for their own and/or organisational purposes and (d) develop an organisational culture whereby superior-subordinate relations, team work and collaboration among sub-units may lead to strengthening healthy work ethos, motivation and pride of employees.

Strategic management of human resources includes assessing staffing needs in the light of strategies formulated and developing a staffing plan for implementation of strategy. The compensation and incentive payments necessary to motivate technically skilled employees and managers also need to be kept in view in connection with the staffing plan. The basic policy in that respect is to be that of linking corporate earnings with individual benefits.

Implementation of strategy often requires changes to be initiated in the organisation structure which may lead to changes in power-relations and scope of social interactions among members. The managers and employees are subjected to changes in their roles, prerogatives and power. New values and priorities as well as the newly formed work groups and informal groups may lead to behavioural resistance to desired improvements. Hence there is necessity of guidelines being provided to facilitate strategy implementation and improve human relations.

There are ways and means to ensure that managerial attitudes and roles match the required strategy implementation efforts. Managers may be transferred to new positions offering scope of career development, promotions, job enlargement and enrichment. Besides workshops may be held aimed at leadership development.

Indeed it is considered important that managerial values, skills and abilities required for implementing strategy should be kept in view at the strategy formulation stage itself. The statements issued by Executives should also reflect their personal commitment to strategy implementation as well as convey their support and rewards for achieving the strategic goals.

The style of management and supervision may require stress on subordinates' involvement in decision-making as much as possible with suitable rewards for valuable suggestions. Basically, the effectiveness of human resource management in the implementation of strategy is achievable through human resource planning, recruitment and selection of staff, training, appraisal of performance and compensation policy.

The purpose of HRM strategy is to reflect and facilitate the achievement of corporate-level strategy by linking the functions of HRM with the strategic goals and objectives—securing competitive advantage either as a cost or price leader or through the unique and differentiated nature of its product, at the same time fostering the development of an appropriate organisational culture.

The following aspects of human resource strategy are required to be focused for the purpose:

- Job analysis and human resource planning before selection and recruitment of manpower,



- Recruitment and selection of staff with required skill and abilities with the process being consistent with the objectives,
- Human resource development by way of training and development programmes, performance appraisal, appropriate compensation package and incentive schemes to secure motivation.

The more important features which human resource strategy may bring to bear on the organisation are as follows:

- (i) **Orientation of the members.** HRM strategy has to ensure that individuals employed in the organisation have necessary orientation so that the mission and objectives of the organisation are internalised by the members and they have a sense of identification with the values and culture of the organisation.
- (ii) **Facilitation of organisational changes as and when called for.** The practices and procedures are required to be in conformity with the changing internal and external conditions. This is a vital role of HR strategy management.
- (iii) **Coping with diversity of workforce.** Modern organisations with highly complex nature of jobs and processes generally have a highly diversified workforce differentiated in terms of age, sex, religion, professional and technical skills and educational background. To maintain a balanced workforce with harmonious relations and providing equitable incentives and rewards are aspects of HRM functions which can sustain an effective workforce. This is a responsibility of HR strategy managers.
- (iv) **Maintaining competent and committed workforce in a competitive environment.** The intensity of market competition for enterprises has been growing fast with globalisation and liberalisation of economic policies. There are competitive strategies of low cost production and differentiation of products which may enable companies to secure a competitive edge. HRM has the responsibility of managing workforce so as to make it competent in ability as well as committed to organisational success.
- (v) **Development of core competency.** An enterprise succeeds in achieving its strategic objectives mainly on the basis of capabilities in the technical, marketing or human skills in areas of crucial importance. These are known as core competencies of the organisation which are unique internal strengths not possessed by competitors. HRM is required to undertake building up of core competency by the organisation as to secure dynamic leadership in the product market.
- (vi) **Empowered workforce as an active resource.** HR strategy is best managed when the members of an organisation are individually in control of their work and are able to realise their potentials with empowerment to take relevant decisions on their own. This is likely to secure enduring performance based achievements.
- (vii) **Appropriate work culture and ethical norms.** No organisation can get the best contribution from its members unless individuals develop a liking for challenging jobs and follow the ethical norms of the organisation functionally. This may require redesigning of jobs and work processes as well as developing trust and confidence among individuals and work groups, as also emphasising intrinsic motivation for improving performance. HRM encompasses creation of an appropriate work culture on the above lines.

Human resource strategic management is concerned with the people dimension of management. Since enterprise is a system of people who interact, it has to depend upon the people. Organisational success and survival, therefore, largely depend on how the people in the organisation will perform, i.e. on how human resources are managed. How does an organisation identify the types of people it needs and then convince them to join? What does it take to train them, to evaluate their performance, and to encourage them to stay with the organisations and contribution to its objectives? All these tasks fall within the realm of human resource strategic management.

The overall objective of human resource strategic management is to strike best match between people and organisation in order to contribute to the successful survival and growth of the organisation and help the people in achieving satisfaction of their economic and other needs. So as to accomplish this objective human resource manager has to perform four strategic functions, viz., acquisition, development, motivation and maintenance. Effective performance of these functions is inevitable in order to cope with bewildering complexity and paroxysm of business activity, technological advancement, increasing ferocity of competition, problem of low productivity and high cost and cataclysmic changes in socio-cultural environment leading to change in profile of workers,



their style of functioning, attitude towards management, towards work and themselves. This is possible only if fruitful alliance between corporate strategy and human resource management is made uniting the organisation's direction with that of its employees. Human resource manager has to strategise human resource function so that its various components are harmonised firmly with corporate strategy towards improving productivity, quality and customer satisfaction.

While designing strategy to motivate employees, the management must bear in mind the following cardinal principles:

- (a) All reasonably healthy adults have a considerable reservoir of potential energy. Differences in the total amount of potential energy are important determinants of motivation.
- (b) All adults have a number of basic motives which can be thought of as values or outlet that channel and regulate the flow of potential energy from this reservoir.
- (c) Most adults within a given socio-cultural system may have the same set of motives or energy outlets that channel and regulate the flow of potential energy from this reservoir.
- (d) Actualisation of motive depends on specific situation in which a person finds himself.
- (e) Certain characteristics of a situation arouse or trigger different motives, opening different values or outlets. Each motive or energy outlet is responsive to a different set of situational characteristics.
- (f) Each motive leads to a different pattern of behaviour.
- (g) By changing the nature of the situational characteristics or stimuli, different motives are aroused or actualised resulting in the emerging of distinct different patterns of behaviour.

There are several strategies for motivating organisation members. Each strategy is aimed at satisfying people's needs through appropriate organisational behaviour. Some of these strategies are discussed below:

1. **Managerial Communication:** The most important and basic strategy for a manager is simply to communicate well with the organisational people. This satisfies such basic human needs as recognition, a sense of belonging, and security. For example, such a simple action as a manager's attempting to become better acquainted with subordinates can contribute substantially to the satisfaction of each of these three needs. As another example, a message from a manager to a subordinate that praises the subordinate for a job well done can help satisfy the subordinate's recognition and security needs.
2. **Theory X and Theory Y:** Another motivation strategy involves manager's assumptions about the nature of people. Douglas McGregor identified two sets of assumptions. According to him, Theory X involves negative assumptions that managers often use as the basis for dealing with people. Theory Y represents positive assumptions which managers strive to use. The basic rationale for using Theory Y rather than Theory X in most situations is that managerial activities reflect Theory X assumptions. As such, the activities based on Theory Y assumptions generally are more successful in motivating organisation people than those based on Theory X assumptions.
3. **Job Design:** A third strategy managers can use to motivate organisation members involves the design of jobs that organisation members perform. Earliest attempt to overcome job boredom was job rotation in which individuals are moved from job to job and thus they are not required to perform a particular job for over the long-term. Subsequently, job enlargement is another strategy developed to overcome the boredom of more simple and specialised jobs. Job enlargement involves increasing the number of operations an individual performs and thereby increasing the individual's satisfaction in work. Job enlargement programme have been found more successful in increasing job satisfaction than have job rotation programmes. In recent years, two other job design strategies, viz., Job Enrichment and Flexitime, have been evolved. Job enrichment is the process of incorporating motivators into a job situation. The job content can be enriched in terms of providing higher responsibility, opportunity for achievement, opportunity for recognition, advancement and learning opportunities. Another more recent job design strategy for motivating organisation members is based on a concept called flexitime or flexible working hour's programmes. The major thrust of this strategy is that it permits workers to choose own working hours within hours within certain limitations. The choices of starting



and finishing times can be as flexible as the organisation allows, to ensure that flexibility does not become counter-productive within the organisation, many flexitime programmes include a core period during which all employees must be on the job. Flexitime strategy has been found resulting in greater job satisfaction which typically results in greater productivity. It can also result in higher motivation levels of workers. This may enable the management in recruiting and attracting qualified employees.

- 4. Behaviour Modification:** Behaviour modification is another strategy which can be used to motivate members of an organisation. Behaviour modification focuses on encouraging appropriate behaviour as a result of the consequences of that behaviour. According to the law of effect, behaviour that is rewarded tends to be repeated and behaviour that punished tends to be eliminated. Behaviour modification strategy emphasises on ensuring that appropriate consequences occur as a result of that behaviour. Positive reinforcement is a desirable consequence of behaviour, and negative reinforcement is the elimination of an undesirable consequence of behaviour. If a worker's arriving on time is positively reinforced, or rewarded, the probability increases that the workers will arrive on time more often. In addition, if the worker experiences some undesirable outcome on arriving late for work, such as a verbal reprimand the worker is negatively reinforced when this outcome is eliminated by on-time arrival. Both positive reinforcement and negative reinforcement are both rewards that increase the likelihood that behaviour will continue. Punishment is the presentation of an undesirable behaviour consequence or the removal of a desirable behavioural consequence that decreases the likelihood of the behaviour continuing. Managers, for example, could punish employees for coming late for work by exposing them to some undesirable consequence. Such as verbal reprimand, or by removing a desirable consequence, such as their wages for the amount of time they are late. Although this punishment probably would quickly cause workers to come to work on time, it might be accompanied by undesirable side effects, such as high levels of absenteeism and turnover, if it were emphasised over the long-term. In order to make behaviour modification programmes successful, it is necessary to give different levels of rewards to different workers depending on the quality of their performance, telling workers what they are doing wrong, punishing workers privately so as to avoid any embarrassment to them and always give rewards and punishments when earned to emphasise that management is serious about behaviour modification efforts.
- 5. Participative Management:** Another strategic approach to employee's motivation is to adopt the system of involving employees in decision making. This will elicit employee's commitment in executing decisions. Further, the successful process of making a decision, executing it and then seeing the positive consequences can help satisfy one's need for achievement, provides recognition and responsibility and enhance self esteem.

Maintenance aspect of human resources is concerned with creation and maintenance of such working conditions in the organisation as are necessary to attract the most talented people, retain them and motivate them to give their best.

For this purpose, existing system of grade salary structure, fixed annual increments and automatic adjustments to inflation has to be replaced by performance linked reward system. Under the new system, employee's reward will be linked to the corporate objectives by pegging it to the employees' contribution towards achieving them. Time has come to develop a comprehensive reward system that splits employees' compensation between company standards, individual merit and team performance. Individual reward system based on attainment of functional specific targets bearing no relationship to corporate performance should give way to team based reward system which pegs rewards of entire manpower of the business division to the achievement of its goals.

10.2 STRUCTURING OF ORGANIZATION FOR IMPLEMENTATION OF STRATEGY

Introduction

Strategy implementation is a critical issue. Strategies remain useless unless they are effectively implemented. Strategy implementation requires a suitable organizational structure to translate the strategies into concrete action plans.

WHAT IS STRATEGIC IMPLEMENTATION?

- *Steiner, Miner and Gray*: "Implementation of strategies is concerned with the design and management of systems to achieve the best integration of people, structures, processes, and resources in reaching organisational purposes.
- *Glueck*: "Strategic implementation is the assignment or reassignment of corporate and SBU leaders to match the strategy. The leaders will communicate the strategy to the employees. Implementation also involves the development of functional policies about the organisation structure and climate to support the strategy and help achieve organisational objectives.
- *Harvey*: "Implementation.....involves actually executing the strategic gameplan. This includes setting policies, designing the organisation structure, and developing a corporate culture to enable the attainment of organisational objectives."

Strategic Implementation

Strategy is dependent on many variables – Internal as well as external. All factors are interrelated.

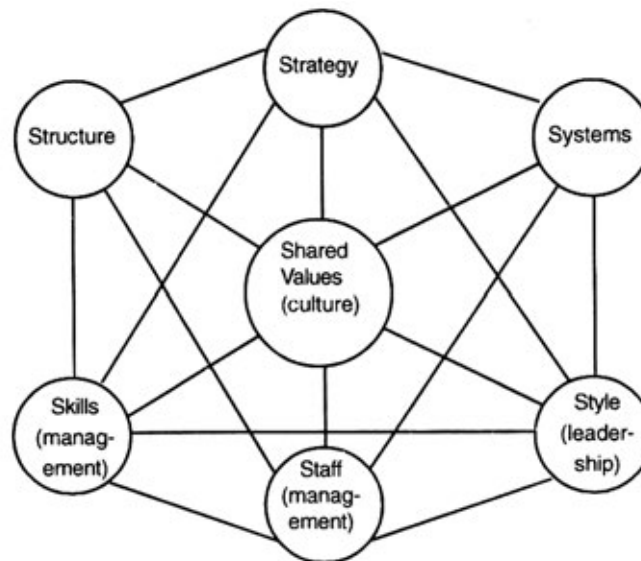

McKinsey's 7-S Framework

The McKinsey Company, a well known management consultancy firm in the United States, towards the end of 1970s was asked to find a solution to this knotty issue. The researchers Peters and Waterman found after examining America's best run companies that the problem in strategy lay in its implementation and structure was only one lever in the hands of management. The other levers were systems, staff, style, skills and superordinate goals. A strategy is usually successful when the other S's in the 7-S framework fit into or support the strategy.

- *Strategy*: A set of decisions and actions aimed at gaining a sustainable competitive advantage.
- *Structure*: The organisation chart and associated information that shows who reports to whom and how tasks are both divided and integrated.
- *Systems*: The flow of activities involved in the daily operation of a business, including its core processes and its support systems.
- *Style*: How managers collectively spend their time and attention and how they use symbolic behaviour. How management acts is more important than what management says.
- *Staff*: How companies develop employees and shape basic values.



- *Shared Values*: Commonly held beliefs, mindsets and assumptions that shape how an organisation behaves—its corporate culture.
- *Skills*: An organisation's dominant capabilities and competencies.

Organizational Structure

The successful implementation of Strategy requires an effective organization structure. Organizational structure means the framework in which the organization defines how tasks are divided, resources are deployed and departments are co-ordinated.

There are several types of organizational structure:

- (1) Functional Structure
- (2) Geographic Structure
- (3) Matrix Structure
- (4) Hybrid Structure

Functional structure:

The functional structure is characterized by the simultaneous combination of similar activities and the separation of dissimilar activities on the basis of function. All Cost Accountants are located in the Cost Accounting Department, and the HOD of Cost Accounting is responsible for all cost related activities. The same is true in marketing, research and development, and manufacturing.

The functional organization form is one of the most common organizational structures found in firms pursuing strategy of concentration or very high relatedness. A functional structure is most appropriate when the organization is small to medium size and relatively stable.

Geographic structure:

Another basic form structural grouping is geographic structure, in which activities and personnel are grouped by specific geographic locations. Each geographic unit includes all functions required to produce and market products in that region.

Organization according to geographic areas or territories is rather common structural form for large-scale enterprise whose strategies need to be tailored to fit the particular needs and features of different.

Matrix structure:

Another way to achieve focus on multiple outcomes is with the matrix structure. The matrix structure creates a dual chain of command; two lines of budget authority and two sources of performance and reward. The key feature of the matrix is that product (or business) and functional lines of authority are overlaid to form a matrix or grid, between the product manager and functional manager.

Hybrid Organization And supplemental Methods:

A single type of structural design is not always sufficient to meet the requirements of strategy. When this occurs, one opinion is to mix and blend the basic organizations forms, matching structure to strategy, requirement by requirement, and unit by unit, Hybrid structure is a form of departmentalization that adopts parts of both functional and divisional structures at the same level of management.

The major potential advantage of the hybrid structures is that the combination may allow the firm to gain the advantages offered by the primary structure while at least diminishing the impact of the disadvantages.

Organizational Structure and Strategy Implementation:

The choice of structure appears contingent on the strategy of the firm. No single structure is appropriate for implementing strategies. The principal task of the organization to choose a suitable structure so that the various elements of an organization fit together and make logical sense.



Strategy Implementation: Views of Experts

- Steiner and Miner: "The implementation of policies and strategies is concerned with the design and management of systems to achieve the best integration of people, structures, processes and resources in reaching organisational purposes."
- Glueck: "Strategic implementation is the assignment or reassignment of corporate and SBU leaders to match the strategy. The leaders will communicate the strategy to the employees. Implementation also involves the development of functional policies about the organisation structure and climate to support the strategy and help achieve organisational objectives".
- Harvey: "Implementation involves actually executing the strategic gameplan. This includes setting policies, designing the organisation structure, and developing a corporate culture to enable the attainment of organisational objectives."

Information technology and Strategy Implementation:

In today's world information technology is playing a very important role in strategic implementation. It is helping organisations to cost effectively develop output and behaviour controls. These in turn is helping strategic managers with better information in many aspects and respond appropriately. Information technology is a form of behaviour control as it helps in standardising behaviour through the use of consistent cross functional software platform. Information technology is a form of output control when all employees or functions use the same software platform to provide up-to date information on their activities. It codifies and standardises organisation knowledge and makes it easier to monitor progress towards strategic objectives. Information technology is also considered to be an integrating mechanism as it provides information at all levels that they need to perform their roles effectively.

Types of Strategic Control Systems:

- **Personal Control**

It is the desire to shape and influence the behaviour of a person in a face to face interaction in order to achieve the organisation's goals. Direct supervision is the most common form of personal control as it helps in identifying the problems faced by subordinates and better man management. Personal control may also come from group of peers when people work in teams. Here personal control is all about possibility of learning to occur and competencies to develop.

- **Output control**

This system involves the estimation and forecasting of appropriate performance goals for each unit/division, department and employees and then measure the actual performance relative to these goals. It is often observed that the organisation's reward system is linked to performance on these goals. It can therefore be concluded that the output control system also provides an incentive structure for motivating employees at all levels of the organisation.

- **Behaviour control**

The establishment of a comprehensive system of rules and procedures to direct the actions or behaviour of divisions, functions and individuals is called behaviour control. The main purpose of having behaviour control is not to specify goals but to standardise the way of reaching them. It is felt that if rules are standardised then outcomes are predictable. It is of utmost importance that the management reviews behaviour controls over time. The rules that have been established tend to increase over time leading to inflexibility to react to the changing environment thereby adversely affecting the organisation's competitive advantage.

10.3 STRATEGY BUSINESS UNIT (SBU)

SBU groups similar divisions into "Strategic Business Units" and then delegate's authority and responsibility of each unit to a senior executive who is normally identified as CEO or MD of that SBU. It is an extension of Divisional structure.



SBU Structure

Big organisation like Unilever, etc have many SBUs for their different categories of products like Cosmetics, Food products and Beverages, etc, and each is managed through separate unit head.

Advantages:

- (i) Promotes accountability since units' heads are responsible for individual SBU profitability
- (ii) Career development opportunities are further higher in this structure
- (iii) Allow better control of categories of products manufacturing, marketing and distributions
- (iv) Helps to expand in different related and unrelated businesses

Disadvantages:

- (i) May provide inconsistent approach to tackle customers, etc, because each unit may work in it's own way to handle situations
- (ii) High cost approach

Matrix Organisation Structure:

The above structures (Functional, Divisional and SBU) consist of flow of authority from top to bottom i.e. vertical flow whereas Matrix structure contains both vertical and horizontal flow of communications or authority. This type of structure is frequently used in IT organisation for managing different projects. Each individual project is managed by a project manager and projects manager will have his team arranged under him.

Advantages:

- (i) Useful for some specific industries like Information Technology, Healthcare etc.
- (ii) Employee can see visible results of their efforts
- (iii) Remove barrier to communications
- (iv) Managing projects are easy
- (v) Effective structures when environment is very dynamic



Disadvantages:

- (i) Complex structure as this contains both vertical and horizontal flow of information
- (ii) High cost approach due to more management positions
- (iii) Dual lines of authority
- (iv) Conflicts arises in the allocation of resources

Strategic Business Units (SBU) & Core Competence:

- SBU is a grouping of related businesses, which is open to complex planning treatment.
- Multi-business enterprise groups it's various businesses into a few distinct business units in a scientific way known as SBUs.
- The purpose is to provide effective strategic planning treatment to each one of it's products /businesses.
- SBU concept is relevant to a multi-product, multi-business enterprises like Unilever Limited
- In other words, the SBU concept helps a multi-business corporation in scientifically grouping it's businesses into a few distinct business units. Such a grouping would in it's turn, help the corporation to carry out it's strategic management practices in better manner.

Some of major reasons of using SBU approach are as follow:

- A scientific method of grouping the businesses of a multi-business corporation which helps the firm in strategic planning.
- An improvement over the geographical grouping of businesses and strategic planning based on locational units.
- An SBU is a grouping of related businesses that can be taken up for strategic planning distinct from the rest of the businesses.
- Grouping the businesses on SBU lines helps the firm in strategic planning by removing the ambiguity and confusion generally seen in grouping businesses.
- Each SBU is a separate business from the strategic planning standpoint. In the basic factors, viz., mission, objectives, competition and strategy-one SBU will be distinct from another.
- Each SBU will have it's own distinct set of competitors and it's own distinct strategy.
- Each SBU will have a CEO. He will be responsible for strategic planning for the SBU and it's profit performance; he will also have control over most of the factors affecting the profit of the SBU.

The three most important Characteristics of SBU are:

- It is a single business or a collection of related businesses which offer scope for independent planning and which might feasibly stand alone from the rest of the organisation.
- Has it's own set of competitors.
- Has a manager who has responsibility for strategic planning and profit performance, and who has control of profit-influencing factors.

10.4 BUSINESS PROCESS RE-ENGINEERING

Business process re-engineering (BPR) is a business management strategy, originally pioneered in the early 1990s, focusing on the analysis and design of workflows and processes within an organization. BPR aimed to help organizations fundamentally rethink how they do their work in order to dramatically improve customer service, cut operational costs, and become world-class competitors. In the mid-1990s, as many as 60% of the Fortune 500 companies claimed to either have initiated reengineering efforts, or to have plans to do so.

BPR seeks to help companies radically restructure their organizations by focusing on the ground-up design of their business processes. According to Davenport (1990) a business process is a set of logically related tasks performed to achieve a defined business outcome. Re-engineering emphasized a holistic focus on business objectives and how processes related to them, encouraging full-scale recreation of processes rather than iterative optimization of subprocesses.

Business process re-engineering is also known as business process redesign, business transformation, or business process change management.

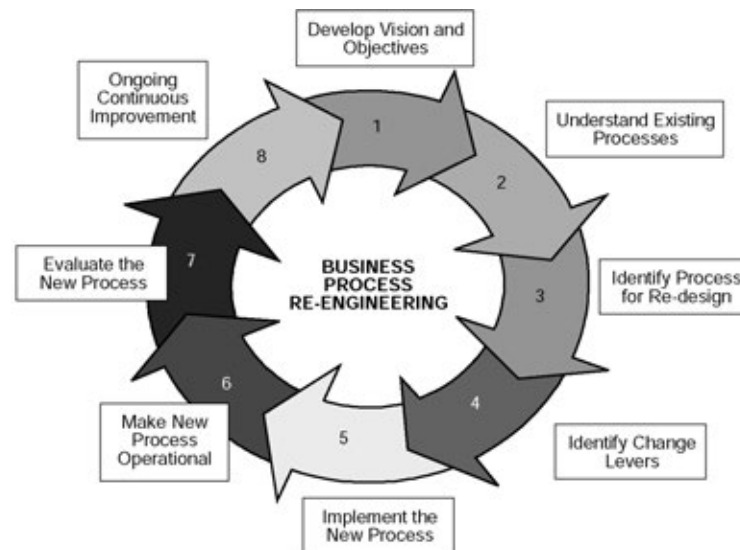

Source: Vakola *et al.* (1998)

The globalization of the economy and the liberalization of the trade markets have formulated new conditions in the market place which are characterized by instability and intensive competition in the business environment. Competition is continuously increasing with respect to price, quality and selection, service and promptness of delivery. Removal of barriers, international cooperation, technological innovations cause competition to intensify. All these changes impose the need for organizational transformation, where the entire processes, organization climate and organization structure are changed. Hammer and Champy provide the following definitions:

Reengineering is the fundamental rethinking and radical redesign of business processes to achieve dramatic improvements in critical contemporary measures of performance such as cost, quality, service and speed.

Process is a structured, measured set of activities designed to produce a specified output for a particular customer or market. It implies a strong emphasis on how work is done within an organization. " (Davenport 1993).

Each process is composed of related steps or activities that use people, information, and other resources to create value for customers as it is illustrated in the following example.

Principle of BPR

BPR is achieving dramatic performance improvements through radical change in organizational processes, rearchitecting of business and management processes. It involves the redrawing of organizational boundaries, the reconsideration of jobs, tasks, and skills. This occurs with the creation and the use of models. Whether those be physical models, mathematical, computer or structural models, engineers build and analyze models to predict the performance of designs or to understand the behavior of devices. More specifically, BPR is defined as the use of scientific methods, models and tools to bring about the radical restructuring of an enterprise that result in significant improvements in performance.

Redesign, retooling and reorchestrating form the key components of BPR that are essential for an organization to focus on the outcome that it needs to achieve. The outcome pursued should be an ambitious outcome (as for instance, are a 24 hour delivery to any customer anywhere in the world, approval of mortgage loans within 60 minutes of application, or ability to have on-line access to a patient's medical records no matter where they are in any major city in the world). These types of visionary goals require rethinking the way most organizations do business,

careful redesign. They will additionally need very sophisticated supporting information systems and a transformation from a traditional organizational structure to a network type organization.

In resuming, the whole process of BPR in order to achieve the above mentioned expected results is based on key steps-principles which include redesign, retool, and reorchestrate. Each step-principle embodies the actions and resources as presented in the table below.

REDESIGN	RETOOL	RECORCHESTRATE
<ul style="list-style-type: none"> • Simplify • Standardize • Empowering • Employeeeship • Groupware • Measurements 	<ul style="list-style-type: none"> • Networks • intranets • extranets • Work Flow 	<ul style="list-style-type: none"> • synchronize ■ process ■ IT ■ human resources

The 3 Rs of re-engineering

Creating the new enterprise involves considerable change in virtually everything to do with people's working lives. Rather than fixing the old, we set out to create the new. There is a fundamental transformation occurring in business - in terms of its structure, processes, people, and technology. The table following presents the changes in that occur in the business under BPR.

Changes in the World of Work

From Conventional	To BPR
Functional departments	Process Teams
Simple tasks (division of labor)	Empowered employees
Controlled people (by management)	Multidimensional work
Training of employees	Education of employees
Compensation for skill and time spent	Compensation for results
Pay raises based on promotions and seniority	Low pay plus high performance-related bonuses
Advancement based on ability	Advancement based on performance
Protective organizational culture	Productive organizational structure
Managers supervise and control	Managers coach and advise
Hierarchical organizational structure	Horizontal (flat) structure
Executives as scorekeepers	Executives as leaders
Separation of duties and functions	Cross-functional teams
Linear and sequential processes	Parallel process
Mass production	Mass customization

Source: Based on Hammer and Champy, 1993.

In resuming, the whole process of BPR in order to achieve the above mentioned expected result is based on key step-principles which include redesigning, retooling and reorchestrating.

Methodology of a BPR project implementation / alternative techniques

BPR is world-wide applicable technique of business restructuring focusing on business processes, providing vast improvements in a short period of time. The technique implements organizational change based on the close coordination of a methodology for rapid change, employee empowerment and training and support by information technology. In order to implement BPR to an enterprise the followings key actions need to take place:

- Selection of the strategic (added-value) processes for redesign.



- Simplify new processes - minimize steps - optimize efficiency -(modeling).
- Organize a team of employees for each process and assign a role for process coordinator.
- Organize the workflow - document transfer and control.
- Assign responsibilities and roles for each process.
- Automate processes using IT(Intranets, Extranets, Workflow Management)
- Train the process team to efficiently manage and operate the new process
- Introduce the redesigned process into the business organizational structure

Most reengineering methodologies share common elements, but simple differences can have a significant impact on the success or failure of a project. After a project area has been identified, the methodologies for reengineering business processes may be used. In order for a company, aiming to apply BPR, to select the best methodology, sequence processes and implement the appropriate BPR plan, it has to create effective and actionable visions. Referring to 'vision' we mean the complete articulation of the future state (the values, the processes, structure, technology, job roles and environment)

For creating an effective vision, basic steps are mentioned below.

- the right combination of individuals come together to form an optimistic and energized team
- clear objectives exist and the scope for the project is well defined and understood
- the team can stand in the future and look back, rather than stand in the present and look forward
- the vision is rooted in a set of guiding principles.

All methodologies could be divided in general 'model' stages:

The Envision stage: the company reviews the existing strategy and business processes and based on that review business processes for improvement are targeted and IT opportunities are identified.

The Initiation stage: project teams are assigned, performance goals, project planning and employee notification are set.

The Diagnosis stage: documentation of processes and sub-processes takes place in terms of process attributes (activities, resources, communication, roles, IT and costs).

The Redesign stage: new process design is developed by devising process design alternatives and through brainstorming and creativity techniques.

The Reconstruction stage: management technique changes occur to ensure smooth migration to the new process responsibilities and human resource roles.

The Evaluation stage: the new process is monitored to determine if goals are met and examine total quality programs.

Expected Results / Benefits

The expected results for a company that implements business process reengineering are the following:

- Reallocation of jobs and processes so as to be combined into fewer, to be executed in natural order, simultaneously and by the least possible number of employees.
- Reorganization of the company's structure (downsizing) and employee empowerment.
- Jobs and processes become flexible so as to be executed according to the needs of each case, company's and customer's need's (hybrid centralized/decentralized operations)

The above changes will bring reductions of costs in the company, better quality (as far as price, promptness of delivery and offerings of related services) in the products and services provided to the customers. BPR shows that there is 'more than one way to skin a cat' and enables a fresh view without ingrained prejudice affecting judgement. It can produce huge initial savings where a business is struggling and often has the affect of turning



around an unprofitable operation. Also, it leaves the business with a fully documented model of the operation, which is invaluable if embarking on a quality programme.

The expected outcome from a successful BPR process should be the desired one for the favor of the business concerned. The dramatic changes that are caused involve people's jobs and working relationships as it is very often that jobs are eliminated and the entire process is not as beneficial for all.

Types of firms / organizations that BPR can be applied

BPR could be implemented to all firms (manufacturing firms, retailers, services, etc.) and public organizations that satisfy the following criteria:

- Minimum Number of employees: 20 (at least 4 in management positions).
- Strong management commitment to new ways of working and innovation.
- Well formed IT infrastructure.

Business Process Reengineering could be applied to companies that confront problems such as the following:

- High operational costs
- Low quality offered to customers
- High level of "bottleneck" processes at peak seasons
- Poor performance of middle level managers
- Inappropriate distribution of resources and jobs in order to achieve maximum performance, etc.

10.5 CORE COMPETENCE AND CRITICAL SUCCESS FACTORS

Core competences are activities or processes that critically underpin an organisation's competitive advantage. The core competences have the following characteristics

- (i) Provide distinctive advantage for the firm
- (ii) Difficult for the competitors to imitate
 - Competence is rare
 - Competence is concerned with managing complex activities or processes
 - Competitors are not clear which resource or competences have caused the success of the firm. This is known as causal ambiguity
 - The competence is embedded in the culture
- (iii) They make a significant contribution to customer value and the end products offered by the firm
- (iv) They provide access to a wide variety of markets

In order to understand this let us take the case of Honda. Honda's core competence lies in design and manufacture of engine and its end products includes motorcycles, cars, generators, lawn-mowers, etc. Similarly the core competences of Canon are optics, imagery and microprocessors and its end products includes cameras, fax machine, image-scanners, etc.

Core skills are fundamental resources of an organisation. It is very important that organisation's should understand the process of developing core competence. Building core competence is a time consuming and challenging exercise. The core competency building process has three stages

- Developing the ability to do something by upgrading or expanding the skills.
- Learning to perform the activity consistently well, so that it transforms in to a competence or capability.



- Sharpening performance such that it becomes better than rivals at performing the activity, thus raising the competence to the rank of a distinctive competence (or competitively superior capability). This opens an avenue to competitive advantage.

Critical Success Factors

Critical Success Factors (CSFs) are those product features which are particularly valued by a group of customers and, therefore, where the organisation must excel in order to outperform competition. According to Rockart there are four major sources of CSFs

- *Structure of the Industry:* Some CSFs are specific to the structure of the industry. For e.g., the extent of service support expected by the customers. Automobile companies have to invest in building a national network of authorized service stations to ensure service delivery to their customers.
- *Competitive strategy, industry position and geographic location:* CSFs also arise from the above factors. For e.g. the large pool of English-speaking manpower makes India an attractive location for outsourcing the BPO needs of American and British firms.
- *Environmental Factors:* CSFs may also arise out of general/business environment of a firm, like the deregulation of Indian industry. With the deregulation of telecommunication industry, many private companies had opportunities of growth.
- *Temporal factors:* Certain short-term organisational developments like sudden loss of critical manpower (like the charismatic CEO) or break-up of the family owned business, may necessitate CSFs like 'appointment of a new CEO' or 'rebuilding the company image'.

In order to identify CSFs in the industry there are three important areas that need to be analysed. They are known as Ohmae's three Cs. They are

Customers:

The important questions that should be considered are

- ✓ *Who are the customers?*
- ✓ *Who are the potential customers?*
- ✓ *Are there any segments?*
- ✓ *Why customers buy from us?*
- ✓ *Why they buy from our competitors?*

The CSFs in this area may relate to:

Price, Service, Product or Service reliability, Quality, Specifications, Branding

Competition

- ✓ *Who are the main competitors?*
- ✓ *How intense is competition?*
- ✓ *What is the necessity to achieve market superiority?*

The CSFs in this area may relate to:

Cost comparisons, Price comparisons, Quality issues, Market dominance, Service distributors

Corporation

- ✓ *What are our key resources and those of our competitors?*
- ✓ *What do they deliver to customers?*
- ✓ *How does the company compare costs, technological skills, organisational ability and marketing with its rivals?*



The CSFs in this area may relate to:

Low cost operations, Economies of Scale, Labour costs, Production output levels, Quality operations, Innovative ability, Labour/management relations, Technologies and copyrights, Skills

However the criticism of CSFs revolve around four issues

1. *Identification*: It is difficult to pick out the important factors that constitute CSFs.
2. *Causality of relationships*: Even though they may have been identified, it may not be clear how they operate or interact.
3. *Dangers of generalising*: The competitive advantage of a particular organisation cannot be obtained by all other organisations in an industry seeking in the same CSFs responsible for bringing success to a particular organisation in an industry.

Self Learning Questions:

1. Critically comment on "Augmented Marketing is provision of traditional customer services and benefits."
2. Critically comment on "Manpower strategy aids in Strategic Management."
3. Discuss McKinsey's 7-S framework.
4. Discuss in brief Structuring of organisation for implementation of strategy.
5. List down various types of organisational structure.
6. What are the areas to keep in mind while framing Production Strategy?
7. Write a short notes on
 - A. Strategic Business Unit
 - B. Business Process Re-engineering
8. List down the steps required in implementation of Strategy.
9. Bring out the features and advantages of SBU.
10. Write short notes on Marketing Mix.
11. Discuss briefly about core competence.
12. Write of short note on Critical Success Factors.



OBJECTIVE TYPE QUESTIONS & ANSWERS

Choosing of Correct Answers:

1. A corporate strategy can be defined as :
 - (a) A list of actions about operational planning and statement of organisation structure and control system;
 - (b) A statement of how to compete, direction of growth and method of assessing environment;
 - (c) Abatement of organisation's activities and allocation of resources;
 - (d) A course of action or choice of alternatives, specifying the resources required to achieve certain stated objectives;
 - (e) A statement of where and how the company will prefer to operate.

Answer:

- (d) A corporate strategy can be defined as: a course of action or choice of alternatives, specifying the resources required to achieve certain stated objectives.
2. Strategic analysis is concerned with stating the position of the organisation in terms of:
 - (a) Mission, choice of market segments, product selection, financial targets, external appraisal;
 - (b) Mission, goals, corporate appraisal, position audit and gap analysis;
 - (c) Mission goals, identification of key competitors, SWOT and environmental appraisal;
 - (d) Mission, targeted ROI, manpower planning, position audit;
 - (e) Mission, SWOT, competitive strategies, stakeholders position and institutional goal.

Answer:

- (b) Strategic analysis is concerned with stating the position of the organization in terms of: mission, goals, corporate appraisal, position audit and gap analysis.
3. Strategic choice makes a statement about the corporate strategy as well as business strategy:
 - (a) They are one and the same;
 - (b) One is an external planning and another resource planning statement;
 - (c) Corporate strategy is a general statement and business strategy defines how a SBU shall operate;
 - (d) Both states certain course of action - one for the total unit and another for a particular business unit;
 - (e) One refers to the whole business and another helps in the formulation of marketing decisions.

Answer:

- (a) Strategic choice makes a statement about the corporate strategy as well as business strategy : the former refers to the whole business while the latter helps in the formulation of marketing and other decisions.
4. Board of directors has certain basic tasks as follows:
 - (a) To define the corporate mission and stop irregular practice;
 - (b) To design the course of strategic options and appointment of top management;
 - (c) To set the ROI and other business performance targets;
 - (d) To monitor plan and keep abreast of external threats;
 - (e) To evaluate and monitor courses of actions.

Answer:

- (a) & (b) Board of directors has certain basic tasks as follows:
 - to define the corporate mission and stop irregular practices; and
 - to design the course of strategic options and appointment of top management.



5. Degree of involvement of Board of Directors may vary from passive to active level. It may participate in one or more of the following activities (state which ones are more appropriate as a judicious mix) :
- (a) It constantly oversees the company's mission, objectives and policies;
 - (b) It approves issues like R&D, foreign collaborations, linkages with financial institutions;
 - (c) Capital budgeting, new product launch and competitive strategy building;
 - (d) It tries to ensure that the company remains aligned with changing social, political and economic milieu;
 - (e) Oversees only the financial performance of the company.

Answer:

- (a) & (b) Degree of involvement of board of directors may vary from passive to active level. It may participate in one or more activities. As a judicious mix, the more appropriate ones are :-
- it constantly oversees the company's mission, objectives and policies; and
 - it approves issues like R&D, foreign collaborations, linkages with financial institutions.
6. A strategic business unit (SUB) is defined as a division of an organisation :
- (a) That help in the marketing operation;
 - (b) That enable managers to have better control over the resources;
 - (c) That help in the choice of technology;
 - (d) That help in the allocation of scarce resources;
 - (e) That help in identifying talents and potentials of people.

Answer:

- (b) A strategic business unit (SBU) is defined as a division of an organization: that enable managers to have better control over the resources.

7. The essential ingredients of Business Process Re-engineering are:
- (a) Continuous improvements of products, processes and technologies.
 - (b) Advanced planning in the areas of technologies, processes and strategic partnerships etc.
 - (c) Fundamental rethinking and radical redesign of business process to achieve dramatic results.
 - (d) Generation, comparison and evolution of many ideas to find out one worthy of development.
 - (e) Identification and selection of layouts most suited for products and processes.

Answer:

The essential ingredients of Business Process Re-engineering are:

- (c) Fundamental rethinking and radical redesign of business process to achieve dramatic results.

8. Mckinsey's 7-s framework consists of:
- (a) Structure, strategy, software, skills, styles, staff and supervision
 - (b) Structure, strategy, systems, skills, styles, syndication and shared values.
 - (c) Structure, strategy, systems, skills, steering power, styles and shared values.
 - (d) Structure, strategy, staff, skills, systems, shared values, super ordinate goal.
 - (e) None of the above.

Answer:

Mckinsey's 7-s framework consists of:

- (d) Structure, strategy, staff, skills, systems, shared values, super ordinate goal.



9. Offensive strategy is a strategy:
- (a) For small companies that consider offensive attacks in the market.
 - (b) For those companies that search for new inventory opportunities to create competitive advantage.
 - (c) For the market leader who should attack the competitor by introducing new products that make existing ones obsolete.
 - (d) For those companies who are strong in the market but not leaders and might capture a market share from the leader.
 - (e) None of the above.

Answer:

Offensive strategy is a strategy:

- (d) For those companies who are strong in the market but not leaders and might capture a market share from the leader.

10. Benchmarking is:

- (a) The analytical tool to identify high cost activities based on the 'Pareto Analysis'.
- (b) The search for industries best practices that lead to superior performance;
- (c) The simulation of cost reduction schemes that help to build commitment and improvement of actions;
- (d) The process of marketing and redesigning the way a typical company works;
- (e) The framework that earmarks a linkage with suppliers and customers;

Answer:

M Benchmarking is:

- (b) The search for industries best practices that lead to superior performance;

11. SAIL's famous advertising campaign of "there is a bit of steel in everyone's life" was meant to:

- (a) gain buyers awareness about its versatile product range;
- (b) create an image of superior performance;
- (c) inform new buyers about its special products;
- (d) enhance product quality perception;
- (e) achieve its mission.

Answer:

SAIL's famous advertising campaign of "there is a bit of steel in everyone's life" was meant to:

- (e) achieve its mission. Or (a) gain buyers awareness about its versatile product range.

12. Marketing Research studies are undertaken :

- (a) to measure brand loyalty of a class of consumers
- (b) to predict market potential of a product on a future date
- (c) to understand product-price relationships
- (d) to make out a case for revision of an existing strategy
- (e) all of the above

Answer:

- (e) all of the above



13. Successful differentiation strategy allows the company to :

- (a) gain buyer loyalty to its brands
- (b) charge too high a price premium
- (c) depend only on intrinsic product attributes
- (d) have product quality that exceeds buyers' needs
- (e) segment a market into distinct group of buyers

Answer:

- (a) gain buyer loyalty to its brands

14. Organization culture is :

- (a) appreciation for the arts in the organization
- (b) ability of the organization to act in a responsible manner to its employees
- (c) combination of (a) and (b) above
- (d) deeper level of basic assumptions and beliefs that are shared by the members of the firm
- (e) none of the above

Answer:

- (d) deeper level of basic assumptions and beliefs that are shared by the members of the firm.

15. Innovation strategy is :

- (a) defensive strategy
- (b) offensive strategy
- (c) responding to or anticipating customer and market demands
- (d) guerrilla strategy
- (e) harvesting strategy

Answer:

- (c) responding to or anticipating customer and market demands

16. Intensity of competition is —— in low return industries.

- (a) low;
- (b) non-existent;
- (c) high;
- (d) not important:
- (e) dependant on industry nature.

Answer:

- (c) high

17. What are enduring statements of purpose that distinguish one business from other similar Firms?

- (a) Policies;
- (b) Mission statements;
- (c) Objectives;
- (d) Rules;
- (e) Nature of ownership.



Answer:

(b) Mission statements

18. Ansoff proposed that for filling the corporate planning gap, one follows four strategies namely.

- (a) market penetration, product differentiation, market identification and diversification;
- (a) market penetration, product development, marketing research and diversification;
- (b) market penetration, product development, market development and diversification;
- (c) market identification, product development, positioning and diversification;
- (d) differentiation, product innovation, market opportunity and diversification.

Answer:

(c) market identification, product development, positioning and diversification

19. The essential ingredients of Business Process Re-engineering (BPR) are

- (a) continuous improvements of products, processes and technologies;
- (b) planning for the technologies, processes and strategic partnerships etc.;
- (c) fundamental re-thinking and radical redesign of business process to achieve dramatic results;
- (d) generation, comparison and evolution of many ideas to find one worthy of development;
- (e) identification and selection of lay-outs most suited for products and processes.

Answer:

(c) fundamental re-thinking and radical redesign of business process to achieve dramatic results

20. Directional Policy Matrix is the same as

- (a) the BCG model;
- (b) the 9-cell GE matrix;
- (c) the Life cycle portfolio analysis;
- (d) the PIMS matrix;
- (e) the 3 X 3 competitive positioning matrix.

Answer:

(b) the 9-cell GE matrix

21. For an actress in Bollywood, her pretty face would be a/an

- (a) Asset
- (b) Strategic asset
- (c) Core competency
- (d) Capability
- (e) All of the above

Answer:

(b) Strategic asset



- 22.** For an entrepreneur
- (a) Vision is before the mission
 - (b) Mission is before the vision
 - (c) Both are developed simultaneously
 - (d) Vision or mission are un-important issue
 - (e) Profitability is most crucial.

Answer:

- (a) Vision is before the mission

- 23.** Which of the following market structures would be commonly identified with FMCG products⁷
- (a) Monopoly
 - (b) Monopolistic competition
 - (c) Oligopoly
 - (d) Perfect competition
 - (e) None of the above

Answer:

- (b) Monopolistic competition

- 24.** The Product Market matrix comprising of Strategies of Penetration, Market Development Product Development and Diversification was first formulated by
- (a) Ansoff
 - (b) Drucker
 - (c) Porter
 - (d) Andrews
 - (e) Prahlad

Answer:

- (a) Ansoff

- 25.** Indian Airlines decreasing the airfare on the Delhi-Mumbai sector following the introduction of the no frills airlines would be an example of
- (a) Cost Leadership
 - (b) Price Leadership
 - (c) Product Differentiation
 - (d) Focus
 - (e) Market Retention

Answer:

- (b) Price Leadership



- 26.** A Product line is a group of products that
- (1) are closely related
 - (2) are marketed through the same channel
 - (3) Perform a similar function for being sold to the same customers
 - (4) All of the above

Answer:

- (4) A product line is a group of products that are **closely related** are **marketed through the same channel** and **perform a similar function** for being sold to the same customers

- 27.** The BCG growth matrix is based on the two dimensions:

- (1) Market Size and Market Share
- (2) Market Size and Profit Margins
- (3) Market Size and Competitive Intensity
- (4) None of the above

Answer:

- (4) None of the above.

BCG Growth Matrix is based on two dimensions - Market Growth Rate and Relative Market Share.

- 28.** Outsourcing is the

- (1) Spinning off of a value-creating activity to create a new firm
- (2) Selling of a value-creating activity to other firms
- (3) Purchase of a value-creating activity from an external supplier
- (4) Use of computers to obtain value-creating data from the Internet

Answer:

- (3) Outsourcing is the purchase of a value-creating activity from external supplier.

- 29.** New entrants to an industry are more likely when.

- (1) It is difficult to gain access to distribution channels
- (2) Economies of scale in the industry are high
- (3) Product differentiation in the industry is low
- (4) Capital requirement in the industry are high

Answer:

- (3) New Entrants to an industry are more likely when product differentiation in the industry is low.

- 30.** The existence of price-wars in the airline industry in India indicates that

- (1) Customers are relatively weak because of the high switching costs created by frequent flyer programs .
- (2) The industry is moving towards differentiation of services
- (3) The competitive rivalry in the industry is severe
- (4) The economic segment of the external environment has shifted, but the airline strategies have not changed

Answer:

- (3) The existence of price -Wars in the airline industry in India indicates that the competitive rivalry in the industry is severe.



31. The managerial task of implementing strategy primarily falls upon the shoulders of:
- (A) The Chief Executive Officer (CEO);
 - (B) First line supervisors, who have day-to-day responsibility for seeing that key activities are done properly;
 - (C) All managers, each attending to what needs to be done in their respective areas of authority and responsibility;
 - (D) All of the above.

Answer:

(C) All managers, each attending to what needs to be done in their respective areas of authority and responsibility.

32. Marketing Research Studies are undertaken:
- (A) to measure brand loyalty of a class of consumers;
 - (B) to predict market potential of a product on a future date;
 - (C) to understand product-price relationships;
 - (D) all of the above.

Answer:

(D) all of the above.

33. Price fixation for the first time takes place when:
- (A) a company develops or acquires a new product;
 - (B) introducing existing product into a new geographic area or a new distribution channel;
 - (C) a service, the company bids for a new contract work;
 - (D) all of the above.

Answer:

(D) all of the above

34. Which of the following market structures would be commonly identified with FMCG products ?
- A. Monopoly B. Monopolistic competition C. Oligopoly D. Perfect competition

Answer:

(i) B-Monopolistic Competition

35. The product-market matrix comprising of strategies of Penetration, Market development. Product development and Diversification was first formulated by
- A. Ansoff B. Drucker C. Porter D. Prahlad

Answer:

(A) Ansoff

36. Typically Profits are highest in which stage of the industry life-cycle ?
- A. Introduction
 - B. Growth
 - C. Maturity
 - D. Decline

Answer:

(B) Growth



37. The strategy which concentrates around a production market is:

- A. Vertical Integration
- B. Niche
- C. Horizontal Expansion
- D. Diversification

Answer:

(B) Niche

38. 'Corporation vision' is the same as

- (A) Corporate dream
- (B) Corporate mission
- (C) Corporate goal
- (D) Corporate strategy

Answer:

(A) Corporate dream

39. 'Niche' is similar to the

- (A) Growth strategy
- (B) Milking strategy
- (C) Flanking strategy
- (D) Survival strategy

Answer:

(C) Flanking strategy

40. Successful 'differential strategy' allows a company to

- (A) Gain buyer loyalty to its brands
- (B) Charge too high a price premium
- (C) Have product quality that exceeds buyers' needs
- (D) Depend only on intrinsic product attributes.

Answer:

(A) Gain buyer loyalty to its brands

41. For an actor in Bollywood, his outstanding performance would be a/an

- (A) Asset
- (B) Strategic asset
- (C) Core competency
- (D) Capability

Answer:

(C) Core competency

42. Intensity of competition is in lower-return industries

- (A) lowest
- (B) non-existent
- (C) highest
- (D) not important

Answer:

(C) Highest

43. A supplier group is powerful if

- (A) It is not concentrated
- (B) Offers unique products
- (C) Its customers can backward integrate
- (D) There are no switching costs

Answer:

(B) Offers unique products



44. A company's actual strategy is
- (A) mostly hidden to outside view and is known only to top-level managers
 - (B) typically planned well in advance and usually deviates little from the planned set of actions and business approaches because of the risks of making on-the-spot changes
 - (C) partly proactive and partly reactive to changing circumstances
 - (D) mostly a function of the strategies being used by rival companies (particularly those companies that are industry leaders)

Answer:

(C) Partly proactive and partly reactive to changing circumstances

45. The reason for failure of Strategic Management may be ascribed to
- A. Over-estimation of resource competence
 - B. Failure to obtain senior management commitment
 - C. Failure to obtain employee commitment
 - D. All of the above

Answer:

(D) All of the above

46. Blue Ocean Strategy is concerned with
- A. moving into new market with new products
 - B. creating a new market places where there is no competition
 - C. developments of products and markets in order to ensure survival
 - D. making the product unique in terms of attributes

Answer:

(B) creating a new market places where there is no competition.

47. For an actor in Bollywood, his outstanding performance would be a /an
- A. Asset
 - B. Strategic Asset
 - C. Core competency
 - D. Capability

Answer:

(C) Core competency

48. A Question Mark in BCG Matrix is an investment, which
- A. Yields low current income but has bright growth prospects.
 - B. Yields high current income and has bright growth prospects.
 - C. Yields high current income and has bleak growth prospects.
 - D. Yields low current income and has bleak growth prospects.

Answer:

(A) Yields low current income but has bright growth prospects.



49. The strategy of the TATAgrou in India could be viewed as a good example of
- A. Conglomerate diversification
 - B. Market development
 - C. Cost Leadership
 - D. Concentric diversification.

Answer:

(A) Conglomerate diversification.

50. Risk Management Strategies are
- A. Avoid Risk, Reduce Risk, Retain Risk, Combine Risk
 - B. Transfer Risk, Share Risk and Hedge Risk
 - C. Both (A) and (B)
 - D. None of the above.

Answer:

(C) Both (A) and (B)

51. Business Process Re-engineering is
- A. Eliminating loss-making process;
 - B. Redesigning operational processes;
 - C. Redesigning the product and services;
 - D. Recruiting the process engineers.

Answer:

(B) Redesigning operational processes.

52. The best test of a successful strategy implementation is
- A. Whether the structure is well matched to strategy;
 - B. Whether the strategies and procedures are observed in a strategy supportive fashion;
 - C. Whether actual organizational performance matches or exceeds the targets spelt out in the strategic plan;
 - D. Whether it is made after the strategy is formulated, so that it is supportive to the strategy.

Answer:

(C) Whether actual organizational performance matches or exceeds the targets spelt out in the strategic plan.

53. Offensive strategy is a strategy
- A. For small companies that consider offensive attacks in the market;
 - B. For those companies that search for new inventory opportunities to create competitive advantage.
 - C. For the market leader who should attack the competitor by introducing new products that makes existing ones obsolete;
 - D. For those companies who are strong in the market but not leaders and might capture a market share from the leader.

Answer:

(D) For those companies who are strong in the market but not leaders and might capture a market share from the leader.



State whether the following statement is True or False:

1. "Dogs" are the products in a high-growth market but where they have a low market share.
2. 'Dogs' are products with a low share, negative growth and negative cash flow.
3. Penetration Pricing is the use of price to drive a competitor out of business.
4. "Strategic Management" is concerned with the formulation of possible courses of actions, their evaluation and the choice between them.
5. 'cash cows' are products in a high-growth market but where they have a low market share.
6. 'Divestment' is pulling out from certain product market areas.
7. Business Process Re-engineering is an important ingredient of Reverse Engineering.
8. Synergy signifies a condition where the whole is greater than the sum of its parts.
9. Brand equity is the added value to the shares held by the equity share-holders of a company.
10. "Benchmarking" is the simulation of cost reduction schemes that help to build commitment and improvement of actions.
11. "Balanced Strategy" is about translating the vision, communicating and linking, business planning, target setting, etc.

Answer:

1. **False** — As per BCG Matrix, "Dogs" are units with low market share in a mature, slow-growing industry.
2. **False** — The correct statement is: '**Dodos**' are products with a low share, negative growth and negative cash flow.
3. **False** — The correct statement is: **Predatory** Pricing is the use of price to drive a competitor out of business.
4. **False** — The appropriate term is 'Strategic choice', instead of 'Strategic management'. Strategic management concerns itself with corporate values, managerial capabilities and organizational responsibilities and systems in a way that links strategic and operational decision making leading to an effective strategy or strategies. But the given statement is indicative of choice of strategy.
5. **False** — The appropriate term is 'question Marks' instead of 'Cash Cows'. Cash cows have high market share in low growth market. Hence the given statement is false.
6. **True**
7. **False**
8. **True**
9. **False**
10. **False** — Benchmarking is the search for industries best practices that leads to superior performance.
11. **False** — "Balanced Score Card" is about translating the vision, communicating and linking, business planning, target setting, etc.



INTERMEDIATE EXAMINATION

June 2019

P-9(O MSM)

Syllabus 2016

Operations management and Strategic Management

Time Allowed: 3 Hours

Full Marks: 100

The figures in the margin on the right side indicate full marks.

This paper contains two Sections.

Both Sections are compulsory, subject to instructions provided against each.

All workings must form part of your answer.

Assumptions, if any, must be clearly indicated.

Section - A

Operations Management

1. (a) Choose the correct answer:

1x10=10

- (i) Inventory cost per product in intermittent production is
 - (A) Higher
 - (B) Lowest
 - (C) Medium
 - (D) Abnormal
- (ii) The act of assessing the future and make provisions for it is known as
 - (A) Planning
 - (B) Forecasting
 - (C) Assessment
 - (D) Scheduling
- (iii) One of the important charts used in Programme control is
 - (A) Material chart
 - (B) Gantt chart
 - (C) Route chart
 - (D) Inspection chart
- (iv) Cost reduction can be achieved through
 - (A) Work sampling
 - (B) Value analysis
 - (C) Quality assurance
 - (D) Supply chain management



- (v) Linear Programming is a technique used for determining
 - (A) Production Programme
 - (B) Plant Layout
 - (C) Product Mix
 - (D) Manufacturing Sequence
- (vi) $(\text{Total station time/cycle time} \times \text{Number of work stations}) \times 100$ is known as
 - (A) Line efficiency
 - (B) Line smoothness
 - (C) Balance delay of line
 - (D) Station efficiency
- (vii) Arrangement of machines depending on sequence of operations happens in
 - (A) Process Layout
 - (B) Product Layout
 - (C) Hybrid Layout
 - (D) Group Technology Layout
- (viii) Line of Best fit is another name given to
 - (A) Method of Least Squares
 - (B) Moving Average Method
 - (C) Semi Average Method
 - (D) Trend Line Method
- (ix) In route sheet or operation layout, one has to show
 - (A) A list of materials to be used.
 - (B) A list of machine tools to be used.
 - (C) Every work center and the operation to be done at that work center.
 - (D) The cost of product.
- (x) Computers are used in Production control in this area
 - (A) follow-up activity.
 - (B) to control labour.
 - (C) to disseminate information.
 - (D) Loading, Scheduling and Assignment works.

(b) Match Column A with Column B:

1x6=6

Column A	Column B
(A) Cost Benefit Analysis	(i) Crashing
(B) Network Analysis	(ii) Product Design
(C) Television Set	(iii) Plant Layout
(D) Use of Templates	(iv) Method Study
(E) Computer Aided Design	(v) Project Viability Checking
(F) Motion Economy	(vi) Assembly Line



(c) State whether the following statements are 'True' or 'False':

1x6=6

- (i) A work stoppage generally reduces the cost of production.
- (ii) Depending on the need, the maintenance activity may be centralized or decentralized.
- (iii) Piece wage system is a substitute for proper supervision.
- (iv) Most suitable layout for continuous production is Matrix Layout.
- (v) Addition of value to raw materials through application of technology is production.
- (vi) Breakdown maintenance doesn't require use of standby machines.

Answer any three questions from the following:

16x3=48

2. (a) List down various activities lying under Production and Operations Management function.
- (b) The present layout is shown in the figure. The manager of the department is intending to interchange the departments C and F in the present layout. The handling frequencies between the departments is given. All the departments are of the same size and configuration. The material handling cost per unit length travel between departments is same. What will be the effect of interchange of departments C and F in the layout? 6+10=16

A	C	E
B	D	F

From / To	A	B	c	D	E	F
A	—	0	80	150	60	10
B	—	-	90	0	90	110
C	-	-	-	40	0	5
D	--	-	-	-	160	20
E	—	-	—	—	—	60
F	-	-	-	-	-	-

3. (a) Examine the following types of Process decisions:

- (i) Job Shop Process
- (ii) Project Process

(b) Describe the different types of Production Control.

(3x2)+10=16

4. (a) A Project consists of four major jobs, for which four contractors have submitted tenders. The tender amounts, in thousands of Rupees, are given below:

Contractor	Jobs			
	A	B	C	D
1	110	98	75	95
2	85	95	115	65
3	105	135	125	98
4	95	95	75	95

Find the assignment, which minimizes the total cost of the Project. Each contractor has to be assigned one job.



- (b) A Taxi operator is planning to open a computerised ticket counter in the center of the city, staffed by one ticket agent. It is estimated that requests for tickets and information will average 18 per hour, and requests will have a Poisson distribution.

Service time is assumed to be exponentially distributed. Previous experience with similar computerised operations suggests that mean service time should average about 2-5 minutes per request.

Determine each of the following:

- (i) System utilization
- (ii) Percentage of time the server (agent) will be idle.
- (iii) The expected number of customers waiting to be served
- (iv) The average time customers will spend in the system.

$$8 + (2 \times 4) = 16$$

5. (a) Table shows the time remaining (number of days until due date) and the work remaining (number of days still required to finish the work) for 5 jobs which were assigned the letters A to E as they arrived to the shop. Sequence these jobs by priority rules viz., (i) FCFS, (ii) EDD, (iii) LS, (iv) SPT and (v) LPT.

Job	Number of days until due date	Number of days of work remaining
A	10	8
B	4	5
C	8	7
D	11	4
E	5	9

- (b) An electronic device components manufacturing company carries out the 'A' components testing for 2500 hours. A sample of 100 'A' components was put through this quality test during which two components failed. If the average usage of the electronic device by the customer is 5 hours/day and if 12,000 such devices were sold, then in one year how many 'A' components were expected to fail and what is the mean time between failures for these components?

$$(2 \times 5) + 6 = 16$$

Section B
Strategic Management

6. Choose the correct answer: 1x6=6
- (i) Offensive strategy is a strategy
 - (A) for small companies that consider offensive attacks in the market.
 - (B) for those companies that search for new inventory opportunities to create competitive advantage.
 - (C) for the market leader who should attack the competitor by introducing new products that make existing ones obsolete.
 - (D) for those companies who are strong in the market but not leaders and might capture a market share from the leader.
 - (ii) The BCG growth matrix is based on the two dimensions:
 - (A) Market Size and Market Share
 - (B) Market Size and Profit Margins
 - (C) Market Size and Competitive Intensity
 - (D) None of the above



- (iii) For an entrepreneur
- (A) Vision is before the mission.
 - (B) Mission is before the vision.
 - (C) Both are developed simultaneously.
 - (D) Vision or mission are un-important issues.
- (iv) Benchmarking is
- (A) the analytical tool to identify high cost activities based on the 'Pareto Analysis'.
 - (B) the search for industries best practices that lead to superior performance.
 - (C) the simulation of cost reduction schemes that help to build commitment and improvement of actions.
 - (D) the process of marketing and redesigning the way a typical company works.
- (v) Strategic analysis is concerned with stating the position of the organisation in terms of
- (A) Mission, choice of market segments, product selection, financial targets and external appraisal.
 - (B) Mission, goals, corporate appraisal, position audit and gap analysis.
 - (C) Mission, goals, identification of key competitors, SWOT and environmental appraisal.
 - (D) Mission, targeted ROI, manpower planning and position audit.
- (vi) Intensity of competition is _____ in low return industries.
- (A) low
 - (B) non-existent
 - (C) high
 - (D) not important

Answer any two questions from the following:

12x2=24

7. (a) What is a Company Mission? List the guidelines for formulation of 'mission' statement.
 (b) Briefly describe the limitations of the BCG model. 8+4=12
8. (a) State the basic distinctions between Strategic Management and Strategic Planning.
 (b) State the various advantages and disadvantages of SBU structure. 6+6=12
9. Write short notes on any three of the following: 4x3=12
- (a) Features of Human Resources Strategy
 - (b) McKinsey's 7-S Framework
 - (c) Principle of BPR
 - (d) Stages involved in Strategic Planning



INTERMEDIATE EXAMINATION

December 2018

P-9(OMSM)

Syllabus 2016

Operations management and Strategic Management

Time Allowed: 3 Hours

Full Marks: 100

The figures in the margin on the right side indicate full marks.

This paper contains two Sections.

Both Sections are compulsory, subject to instructions provided against each.

All workings must form part of your answer.

Assumptions, if any, must be clearly indicated.

Section - A

Operations Management

1. (a) Choose the correct answer: 1×10=10
- (i) Which one of the following recent trends in Production/Operations management involves drastic measures or break through improvements to improve the performance of a firm?
- (A) Corporate Downsizing
 - (B) Re-Engineering
 - (C) Technology
 - (D) TQM
- (ii) The starting point of Production cycle is
- (A) Product design
 - (B) Production planning
 - (C) Routing
 - (D) Market research
- (iii) Which of the following process types is used when a very highly standardized product is desired in high volumes?
- (A) Repetitive Process
 - (B) Batch Process
 - (C) Project Process
 - (D) Continuous Process
- (iv) Which of the following aims at finding the best and most efficient way of using the available resources—men, materials, money and machinery?
- (A) Method Study
 - (B) Work Study
 - (C) Time Study
 - (D) Motion Study



- (v) Generally the size of the order for production in Job production is
- (A) small
 - (B) large
 - (C) medium
 - (D) very large
- (vi) Which one of the following statements is NOT correct?
- (A) LFT is calculated from the LFT of the head event.
 - (B) Slack can be calculated by adding EFT and LFT of any job.
 - (C) EFT is the sum of the EST and the time of duration for any event.
 - (D) The Total Project time is the shortest possible time required in completing the project.
- (vii) Which one of the following is NOT the advantage of Preventive Maintenance?
- (A) Better product quality
 - (B) Greater safety to workers
 - (C) Increased breakdowns and downtime
 - (D) Fewer large-scale repairs
- (viii) Which one of the following establishes time sequence of operations?
- (A) Routing
 - (B) Sequencing
 - (C) Scheduling
 - (D) Dispatching
- (ix) MRP stands for
- (A) Material Requirement Planning
 - (B) Material Reordering Planning
 - (C) Material Requisition Procedure
 - (D) Material Recording Procedure
- (x) With reference to Aggregate Planning, identify which of the following statements is NOT correct?
- (A) It is an Intermediate-term planning.
 - (B) It is made operational through a master schedule, that gives the manufacturing schedule.
 - (C) Facility planning and scheduling are closely related with the aggregate planning.
 - (D) It deals with the strategic decisions, such as purchase of facilities, introduction of new products, processes, etc.



(b) Match Column A with Column B:

1×6=6

Column A	Column B
(A) Any place in a production process where materials tend to pile up or produced at rates of speed less rapid than the previous or subsequent operations	(i) Assignment
(B) It is used when a low volume of high variety goods are needed	(ii) Globalisation
(C) A special Linear Programming Problem	(iii) Bottleneck
(D) Steep increase in the level of competition among manufacturing firms throughout the world	(iv) Maintenance Request
(E) Systematic Quantitative structural approach to the problem of managing a project through to successful completion	(v) Job-Shop Process
(F) This must be made in writing to a central point in the organization	(vi) Network Analysis

(c) State whether the following statements are 'True' or 'False':

1×6=6

- (i) Short-term forecasting is useful to serve the purpose of estimating the inventory requirement.
- (ii) The life cycle of a product has many points of similarity with the human life cycle.
- (iii) The Linear Programming problem has two basic parts: the objective function and the constraint set.
- (iv) The most widely used index of productivity is to work out the output per machine-hour.
- (v) PERT is designed for repetitive projects, whereas CPM is suitable for non-repetitive projects.
- (vi) Wear and obsolescence are two main causes for replacement of machinery in every aspect of life.

Answer any three questions from the following:

16×3= 48

2. (a) Explain the concept of Operating System in order to have a clear idea of Operations Management.

(b) With the help of following data, project the trend of sales for the next 5 years:

6+10=16

Years	2002	2003	2004	2005	2006	2007
Sales in Lakhs of Rupees	120	130	135	140	150	165

3. (a) What are the various activities and responsibilities of product design?

(b) Describe the objectives of Production Planning and Control.

6+10=16

4. (a) Find initial Feasible Solution by North-West Corner method.

	W1	W2	W3	W4	SUPPLIES
F1	47	59	55	57	150
F2	44	54	52	59	270
F3	49	64	59	61	370
F4	51	63	54	60	230
DEMAND	210	330	260	220	

W_j -> Warehouse

F_j -> Factory, and

Cell entries are unit costs.



- (b) A departmental store is running a snack items selling outlet. Past data of snack items' demand per week in hundred kgs with frequency is given below:

Demand/Week	0	6	12	18	24	30
Frequency	3	10	9	20	6	2

Using the following sequence of random numbers, generate the demand for next 10 weeks. Also find out the average demand per week.

Random Numbers	21	34	48	97	72	31	45	56
	47	37	82	44	67	75	63	

$$6 + (8 + 2) = 16$$

5. (a) Draw the network for the following activities and find the critical path and total duration of the project.

Activity	Duration(months)
1-2	3
2-3	4
2-4	5
2-5	6
3-4	3
3-6	5
4-6	7
5-6	4
6-7	5

- (b) An automotive firm is using a machine whose purchase price is ₹ 18,000.

The Installation charges amount to ₹3,800 and the machine has a scrap value of only ₹1,800 because the firm has a monopoly of this type of work. The maintenance cost in various years is given in the following table:

Year	1	2	3	4	5	6	7	8	9
Maintenance cost (₹)	250	720	1200	1700	2300	3200	4300	4800	6300

The firm wants to determine after how many years should the machine be replaced on economic considerations, assuming that the machine replacement can be done only at the year end. $(2 \times 3) + 10 = 16$

SECTION – B

Strategic Management

6. Choose the correct answer:

1×6=6

- (i) A corporate strategy can be defined as

- (A) A list of actions about operational planning and statement of organisation structure and control system.
- (B) A statement of how to compete, direction of growth and method of assessing environment.
- (C) Abatement of organisation's activities and allocation of resources.
- (D) A course of action or choice of alternatives, specifying the resources required to achieve certain stated objectives.



- (ii) The existence of price-wars in the airline industry in India indicates that
- (A) customers are relatively weak because of the high switching costs created by frequent flyer programmes.
 - (B) the industry is moving towards differentiation of services.
 - (C) the competitive rivalry in the industry is severe.
 - (D) the economic segment of the external environment has shifted, but the airline strategies have not changed.
- (iii) Business Process Re-engineering is
- (A) eliminating loss-making process.
 - (B) redesigning operational processes.
 - (C) redesigning the product and services.
 - (D) recruiting the process engineers.
- (iv) Which one or more of the following are appropriate as a judicious mix for a Product line, which is a group of products?
- (A) That are closely related.
 - (B) That are marketed through the same channel.
 - (C) That perform a similar function for being sold to the same customers.
 - (D) All of the above
- (v) The Product Market matrix comprising of Strategies of Market Penetration, Market Development, Product Development, and Diversification was first formulated by
- (A) Ansoff
 - (B) Drucker
 - (C) Porter
 - (D) Prahlad
- (vi) Price fixation for the first time takes place when
- (A) a company develops or acquires a new product.
 - (B) introducing existing product into a new geographic area or a new distribution channel.
 - (C) a service, the company bids for a new contract work.
 - (D) All of the above

Answer any two questions from the following:

12×2=24

7. (a) 'There are primarily three levels of strategies in the organisation'. List the three levels. Build up one or two meaningful sentences to clarify the role of each level.
- (b) What is meant by SWOT analysis? 8+4=12
8. (a) Categorise seven-steps process of Contingency Planning.
- (b) How does Matrix Organisation Structure differ from SBU Structure? Analyse related advantages and disadvantages of Matrix Organisation Structure. 6+6=12
9. Write short notes on any three of the following: 4×3=12
- (a) Corporate Planning
 - (b) Definition of the terms 'Re-engineering' and 'Process' in Business Process Re-engineering
 - (c) Stages of Strategic Management Framework
 - (d) Steps involved in the formulation of production strategy



INTERMEDIATE EXAMINATION

June 2018

P-9(OMSM)

Syllabus 2016

Operations management and Strategic Management

Time Allowed: 3 Hours

Full Marks: 100

The figures in the margin on the right side indicate full marks.

This paper contains two Sections.

Both Sections are compulsory, subject to instructions provided against each.

All workings must form part of your answer.

Assumptions, if any, must be clearly indicated.

Section - A

Operations Management

1. (a) Choose the correct answer:

1x10=10

- (i) The recent trend in the Production/Operations management which suggests the use of minimal amount of resources to produce a high volume of high quality goods with some variety is referred to as:
 - (a) SCM
 - (b) TQM
 - (c) Lean Production
 - (d) Just-In-Time
- (ii) Effective capacity can NOT be determined by which of the following factors?
 - (a) Product design and product-mix
 - (b) Quantity and quality capabilities
 - (c) Facilities
 - (d) None of the above
- (iii) In which of the following stages the management should try to change its approach by changing its strategy from "buy my product" to "try my product"?
 - (a) Introduction
 - (b) Growth
 - (c) Maturity
 - (d) Decline
- (iv) Conducting occasional check-ups of the products manufactured or assembled to ensure high quality of the production is known as:
 - (a) Planning
 - (b) Scheduling
 - (c) Inspection
 - (d) Routing



- (v) Which one of the following standards is associated with the "Quality Assurance in Final Inspection Test"?
- (a) ISO 9001
 - (b) ISO 9002
 - (c) ISO 9003
 - (d) ISO 9004
- (vi) With reference to project management, identify which of the following statement is NOT correct?
- (a) Gantt chart is a principal tool used in scheduling and also in some methods of loading.
 - (b) Routing is the first step in the production planning.
 - (c) The cost of any activity is proportional to its time of completion.
 - (d) The free float can be calculated by subtracting EFT from EST.
- (vii) Identify which one of the following statement is NOT correct?
- (a) Preventing maintenance includes lubrication, cleaning, periodic overhaul, etc.
 - (b) The two types of cost-cost of premature replacement and cost of breakdown-need to be balanced.
 - (c) Wear and obsolescence are the two main causes of replacement of machinery in every aspect of life.
 - (d) A machine is technically obsolete when another machine can do the same job more efficiently with reduced time and also at a lower cost.
- (viii) To determine where the plant should be located for maximum operating economy and effectiveness, refers to which one of the following?
- (a) Plant layout
 - (b) Facility location
 - (c) Capacity planning
 - (d) Capacity requirement
- (ix) Which of the following models deals with the physical movement of goods from different supply origins to a number of different demand destinations?
- (a) Simulation
 - (b) Transportation
 - (c) Lean operations
 - (d) Line balancing
- (x) One of the objectives of maintenance is:
- (a) to prevent obsolescence.
 - (b) to ensure spare parts management.
 - (c) to satisfy customers.
 - (d) to extend the useful life of Plant & Machinery without sacrificing the level of performance.



(b) Match Column A with Column B:

1x6=6

Column A	Column B
(A) The ability to adapt quickly to changes in volume of demand, in the product mix demanded and in product design or in delivery schedules	(i) Method Study
(B) To address the planning and controlling of a manufacturing process and all of its related support functions	(ii) Maintenance Stores
(C) Degree to which the system can be adjusted to changes in processing requirements	(iii) Flexibility
(D) Eliminating unnecessary motions or by changing the sequence of operation or the process itself	(iv) Network Analysis
(E) Certain specific techniques which can be used for planning, management and control of project	(v) MRP-II
(F) Availability of vital spare parts needs to be ascertained to meet an emergency like breakdown	(vi) Process Flexibility

(c) State whether the following statements are 'True' or 'False':

1x6=6

- (i) The primary concern of production planning and control is the delivery of products to customers or to inventory stocks according to some predetermined schedule.
- (ii) Capacity refers to the minimum load an operating unit can handle.
- (iii) Job-shop process is used when a very highly standardized product is desired in high volumes.
- (iv) The productivity is a measure of how much input is required to achieve a given output.
- (v) One of the limitations of Gantt Chart is that it does not clearly indicate the details regarding progress of activities.
- (vi) Preventive maintenance ensures greater safety to workers.

Answer any three questions from the following:

16x3=48

2. (a) Categorise the objectives of operations management and discuss about each category. 2+4=6

(b) The monthly requirement of raw material for a company is 3200 units. The carrying cost is estimated to be 25% of the purchase price per unit, in addition to ₹ 2.5 per unit. The purchase price of raw material is ₹ 24 per unit.

The ordering cost is ₹ 28 per order.

- (i) You are required to find EOQ and Total cost.
- (ii) What is the total cost when the company gets a concession of 6% on the purchase price if it orders 3200 units or more but less than 6200 units per month?
- (iii) What happens when the company gets a concession of 15% on the purchase price when it orders 6,200 units or more?
- (iv) Which of the above three ways of orders the company should adopt? 4+2+2=10

3. (a) "Virtually all goods or services are made by using some variation of one of three process Strategies". Discuss about each of the three process strategies. Also state the situation during the decline stage of a product life cycle. (2x3)+2=8

(b) Discuss the principles of scheduling. Explain briefly the relationship between routing and scheduling. 6+2=8



4. (a) A blacksmith supervisor in his workshop is considering how he should assign the four jobs that are to be performed, to four of the workers under him. He wants to assign the jobs to the workers such that the aggregate time to perform the jobs is the least. Based on previous experience, he has the information on the time taken by the four workers in performing these jobs and the same is given in the table below:

Time Taken (in minutes) by 4 Workers

Worker	Job			
	A	B	C	D
1	46	40	51	68
2	57	42	63	55
3	49	53	48	64
4	41	45	61	55

Solve the assignment problem for optimal solution using Hungarian Method.

8

- (b) At a tool service centre, the arrival rate is 3 per hour and the service potentials 4 per hour. Simple queue conditions exist. The hourly wage paid to the attendant at the service centre is ₹ 2 per hour and the hourly cost of a machinist away from his work is ₹ 5.

Calculate:

2x4=8

- (i) The average number of machinists being served or waiting to be served at any given time.
- (ii) The average time a machinist spends waiting for service.
- (iii) The total cost of operating the system for an eight-hour day.
- (iv) The cost of the system if there were two attendants working together as a team, each paid ₹ 2 per hour and each able to service on average 3 per hour.

5. (a) The following jobs have to be shipped a week from now(week has 5 working days)

Job	A	B	C	D	E	F
Number of day's work remaining	4	5	8	7	6	3

Sequence the jobs according to priority established by:

4x2=8

- (i) Least slack rule
- (ii) Critical ratio rule

- (b) A cab operations company is experiencing the following number of breakdowns for months over the past 2 years in their new fleet of cabs:

Number of breakdowns	0	1	2	3	4
Number of months this occurred	3	7	9	4	1

Each breakdown costs the firm an average of ₹ 2,500. For a cost of ₹ 1,600 per month, preventive maintenance can be carried out to limit the breakdowns to an average of one per month. Which policy is suitable for the firm?

8



Section - B
(Strategic Management)

6. Choose the correct answer: 1×6=6
- (i) Which one of the following does NOT seem to be an advantage of the strategic management?
- (a) Discharges board responsibility
 - (b) Provides a framework for decision-making
 - (c) Forces an objective assessment
 - (d) It can be expensive
- (ii) Which of the following analyses 'products and businesses by market share and market growth'?
- (a) SWOT Analysis
 - (b) BCG Matrix
 - (c) PEST Analysis
 - (d) Portfolio Analysis
- (iii) Which one of the following is NOT part of the McKinsey's 7-S framework?
- (a) Skills
 - (b) Staff
 - (c) Systems
 - (d) Supervision
- (iv) Which one of the following statement is NOT correct?
- (a) Vision is the statement of the future.
 - (b) The corporate mission is the purpose or reason for its existence.
 - (c) Targets are formed from vision and mission statement of organizations.
 - (d) Goals are objectives that are scheduled for attainment during planned period.
- (v) Which of the following can NOT be called as a strength of an organization?
- (a) Good Industrial relations
 - (b) Incentives from State Government
 - (c) Financially very sound
 - (d) Raw materials source at a distance
- (vi) Strategic Business Unit (SBU) structure does NOT experience one of the following as an advantage:
- (a) Higher career development opportunities
 - (b) Better control of categories of products manufacturing, marketing and distributions
 - (c) High cost approach
 - (d) Help in expanding in different related and unrelated businesses



Answer any two questions from the following:

12×2=24

7. (a) Identify basic elements of strategic vision and discuss about the important purposes served by such strategic vision. $1\frac{1}{2} + 2\frac{1}{2} = 4$
(b) Discuss in brief about the areas of attention for SWOT appraisal. State the purpose of such appraisal. 6+2=8
8. (a) State the different approaches in Strategic Planning. 4
(b) Categorise major reasons of SBU approach. 8
9. Write short notes on any three of the following: 4×3=12
(a) Marketing Plan and Strategy
(b) Geographic and Matrix structure for implementation of organisational strategy
(c) Types of firms/organisations for which BPR can be applied
(d) Difference between strategic management and strategic planning

The Directorate of Studies is committed to keep abreast of CMA Students with the latest amendments/notifications/advancements on each subject on regular basis. Students are requested to visit CMA Students' Portal [<https://icmai.in/studentswebsite/>] regularly to view the updates.