

INTERMEDIATE : PAPER -

8

SYLLABUS - 2016

# COST ACCOUNTING

INTERMEDIATE

## STUDY NOTES



**The Institute of Cost Accountants of India**

CMA Bhawan, 12, Sudder Street, Kolkata - 700 016

First Edition: July 2016  
Revision: October 2017  
Revised Edition: January 2018  
Reprint: January 2019  
Edition: August 2019  
Edition: October 2019  
Reprint: August 2020  
Reprint: October 2020  
Reprint : January 2021  
Reprint : March 2021  
Reprint : September 2021  
**Reprint : January 2022**

**Published by :**

Directorate of Studies  
The Institute of Cost Accountants of India  
CMA Bhawan, 12, Sudder Street, Kolkata - 700 016

**Printed at :**

M/s. Sap Prints Solutions Pvt. Ltd.  
28A, Lakshmi Industrial Estate  
S.N. Path, Lower Parel (W)  
Mumbai - 400 013, Maharashtra

---

Copyright of these Study Notes is reserved by the Institute of Cost Accountants of India and prior permission from the Institute is necessary for reproduction of the whole or any part thereof.

---

# Syllabus - 2016

## PAPER 8: COST ACCOUNTING (CAC)

### Syllabus Structure:

The syllabus comprises the following topics and study weightage:

A	Introduction to Cost Accounting	40%
B	Methods of Costing	30%
C	Cost Accounting Techniques	30%

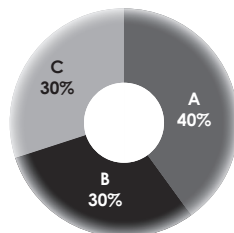

### ASSESSMENT STRATEGY

There will be examination of three hours.

### OBJECTIVES

To provide an in depth study of the Cost Accounting Principles and Techniques for identification, analysis and classification of cost components to facilitate managerial decision making.

### Learning aims

The syllabus aims to test the student's ability to:

- Understand and explain the conceptual framework of Cost Accounting
- Explain the basic concepts and processes in determination of cost of products and services
- Understand the Cost Accounting Standards (CAS)
- Apply marginal costing in decision making
- Apply the concept of Standard Costing for variance analysis

### Skill set required

Level B: Requiring the skill levels of knowledge, comprehension, application and analysis.

1.	<b>Introduction to Cost Accounting</b>	40%
	A. Cost Ascertainment - Elements of Cost	
	B. Cost Accounting Standards	
	C. Cost Book Keeping	
2.	<b>Methods of Costing</b>	30%
3.	<b>Cost Accounting Techniques</b>	30%

## INTRODUCTION TO COST ACCOUNTING [40 MARKS]

### 1. INTRODUCTION TO COST ACCOUNTING:

- (a) Definition, Scope, objectives and significance of cost accounting, its relationship with financial accounting and management accounting
- (b) Cost Objects, Cost centers and Cost Units
- (c) Elements of cost
- (d) Classification of costs

### 2. COST ASCERTAINMENT - ELEMENTS OF COST:

#### (a) Material Costs:

- (i) Procurement of Materials,
- (ii) Inventory Management and Control,

- (iii) Inventory Accounting & Valuation
- (iv) Physical Verification, treatment of losses
- (v) Scrap, spoilage, defectives and wastage.

**(b) Employee Costs:**

- (i) Time keeping, Time booking and payroll,
- (ii) Labour Turnover, Overtime and idle time
- (iii) Principles and methods of remuneration and incentive schemes
- (iv) Employee cost reporting and measurement of efficiency.

**(c) Direct Expenses**

**(d) Overheads:**

- (i) Collection, classification and apportionment and allocation of overheads
- (ii) Absorption and treatment of over or under absorption of overheads
- (iii) Reporting of overhead costs

**3. COST ACCOUNTING STANDARDS (Basic Understanding only)**

**(CAS 1 to CAS 24)**

**4. COST BOOK KEEPING:**

- (a) Cost Accounting Records, Ledgers and Cost Statements
- (b) Items excluded from cost and normal and abnormal items/cost
- (c) Integral accounts
- (d) Reconciliation of cost accounting records with financial accounts
- (e) Infrastructure, Educational, Healthcare and Port services

**METHODS OF COSTING [30 MARKS]**

**5. METHODS OF COSTING:**

- (a) Job Costing
- (b) Batch Costing
- (c) Contract Costing
- (d) Process Costing – Normal and abnormal losses, equivalent production, Joint and By Products.
- (e) Operating Costing or Service Costing – Transport, Hotel and Hospital

**COST ACCOUNTING TECHNIQUES [30 MARKS]**

**6. COST ACCOUNTING TECHNIQUES: (Basic Understanding only)**

- (A) Marginal Costing
  - (i) Meaning of Marginal Cost and Marginal Costing
  - (ii) Absorption Costing vs. Marginal Costing
  - (iii) Break-even analysis
  - (iv) Margin of safety
  - (v) Application of Marginal Costing for decision making **(simple problems only)**
- (B) Standard Costing & Variance Analysis
  - (i) Concept of standard cost and standard costing
  - (ii) Advantages and limitations
  - (iii) Computation of variances relating **to material and labour costs only**
- (C) Budget and Budgetary Control (simple problems only)
  - (i) Concepts, Types of Budgets
  - (ii) Budgetary Control Vs Standard Costing
  - (iii) Advantages and limitations
  - (iv) Preparation of Budgets **(simple problems only)**

# Contents

## COST ACCOUNTING

### Study Note 1 : Introduction to Cost Accounting

1.1	Definition, scope, objectives and significance of Cost Accounting, its relationship with Financial Accounting and Management Accounting	1
1.2	Cost Object, Cost Centers and Cost Units – Elements of Cost	8
1.3	Classification of Cost	14
1.4	Role of Cost Accountants in Organisations	23

### Study Note 2 : Cost Ascertainment - Elements of Cost

2.1	Material Cost (CAS-6)	29
2.2	Employee Costs (CAS-7)	82
2.3	Direct Expenses (CAS-10)	133
2.4	Overheads (CAS-3)	137

### Study Note 3 : Cost Accounting Standards

3.1	Preface to Cost Accounting Standards (CASs)	191
3.2	Objectives and Functions of Cost Accounting Standards Board	192
3.3	CAS 1-24 as issued by The Institute of Cost Accountants of India	194

### Study Note 4 : Cost Book Keeping

4.1	Cost Accounting Records, Ledgers and Cost Statements	205
4.2	Items excluded from Cost and Normal and Abnormal Items/Cost	220
4.3	Non-Integrated Accounting	221
4.4	Integral Accounts	226
4.5	Reconciliation of Cost Accounting Records with Financial Accounts	236
4.6	Infrastructure, Educational, Healthcare and Port Services	249

### Study Note 5 : Methods of Costing

5.1	Job Costing	261
5.2	Batch Costing	275

5.3	Contract Costing	279
5.4	Process Costing – Joint & By-Products	297
5.5	Operating Costing or Service Costing – Transport, Hotel and Hospital	329

### **Study Note 6 : Cost Accounting Techniques**

6.1	Marginal Costing	353
6.2	Standard Costing & Variance Analysis	396
6.3	Budget and Budgetary Control	425

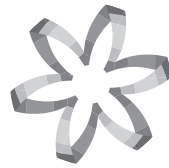

# Cost Accounting









# Study Note - 1

## INTRODUCTION TO COST ACCOUNTING

### This Study Note includes

- 1.1 **Definition, scope, objectives and significance of Cost Accounting its relationship with Financial Accounting and Management Accounting**
- 1.2 **Cost Objects, Cost Centres and Cost Units – Elements of Cost**
- 1.3 **Classification of Costs**
- 1.4 **Role of Cost Accountants in organisations**

### 1.1 DEFINITION, SCOPE, OBJECTIVES AND SIGNIFICANCE OF COST ACCOUNTING, ITS RELATIONSHIP WITH FINANCIAL ACCOUNTING AND MANAGEMENT ACCOUNTING

Way back to 15th Century, no accounting system was there and it was the barter system prevailed. It was in the last years of 15th century Luca Pacioli, an Italian found out the double entry system of accounting in the year 1494. Later it was developed in England and all over the world upto 20th Century. During these 400 years, the purpose of Cost Accounting needs are served as a small branch of Financial Accounting except a few like Royal wallpaper manufactory in France (17th Century), and some iron masters & potters (18th century).

The period 1880 AD- 1925 AD saw the development of complex product designs and the emergence of multi activity diversified corporations like Du Pont, General Motors etc. It was during this period that scientific management was developed which led the accountants to convert physical standards into Cost Standards, the latter being used for variance analysis and control.

During the World War I and II the social importance of Cost Accounting grew with the growth of each country's defence expenditure. In the absence of competitive markets for most of the material required for war, the governments in several countries placed cost-plus contracts under which the price to be paid was cost of production plus an agreed rate of profit. The reliance on cost estimation by parties to defence contracts continued after World War II.

In addition to the above, the following factors have made accountants to find new techniques to serve the industry :-

- (i) Limitations placed on financial accounting
- (ii) Improved cost consciousness
- (iii) Rapid industrial development after industrial revolution and world wars
- (iv) Growing competition among the manufacturers
- (v) To control galloping price rise, the cost of computing the precise cost of product / service
- (vi) To control cost several legislations passed throughout the world and India too such as Essential Commodities Act, Industrial Development and Regulation Act... etc.

Due to the above factors, the Cost Accounting has emerged as a specialised discipline from the initial years of 20th century i.e after World War I and II.



In India, prior to independence, there were a few Cost Accountants, and they were qualified mainly from I.C.M.A. (now CIMA) London. During the Second World War, the need for developing the profession in the country was felt, and the leadership of forming an Indian Institute was taken by some members of Defence Services employed at Kolkata. However, with the enactment of the Cost and Works Accountants of India Act, 1959, the Institute of Cost and Works Accountants of India (Now called as The Institute of Cost Accountants of India) was established at Kolkata. The profession assumed further importance in 1968 when the Government of India introduced Cost Audit under section 233(B) of the Companies Act, 1956. At present it is under Section 148 of the Companies Act, 2013.

Many times we use Cost Accounting, Costing and Cost Accountancy interchangeably. But there are differences among these terms. As a professional, though we use interchangeably we must know the meaning of each term precisely.

**Cost Accounting** : Cost Accounting may be defined as “Accounting for costs classification and analysis of expenditure as will enable the total cost of any particular unit of production to be ascertained with reasonable degree of accuracy and at the same time to disclose exactly how such total cost is constituted”. Thus Cost Accounting is classifying, recording an appropriate allocation of expenditure for the determination of the costs of products or services, and for the presentation of suitably arranged data for the purpose of control and guidance of management.

Cost Accounting can be explained as follows :-

Cost Accounting is the process of accounting for cost which begins with recording of income and expenditure and ends with the preparation of statistical data. It is the formal mechanism by means of which cost of products or services are ascertained and controlled.

Cost Accounting provides analysis and classification of expenditure as will enable the total cost of any particular unit of product / service to be ascertained with reasonable degree of accuracy and at the same time to disclose exactly how such total cost is constituted. For example it is not sufficient to know that the cost of one pen is ₹ 25/- but the management is also interested to know the cost of material used, the amount of labour and other expenses incurred so as to control and reduce its cost. It establishes budgets and standard costs and actual cost of operations, processes, departments or products and the analysis of variances, profitability and social use of funds.

Thus Cost Accounting is a quantitative method that collects, classifies, summarises and interprets information for product costing, operation planning and control and decision making.

**Costing : Costing is defined as the technique and process of ascertaining costs.**

The technique in costing consists of the body of principles and rules for ascertaining the costs of products and services. The technique is dynamic and changes with the change of time. The process of costing is the day to day routine of ascertaining costs. It is popularly known as an arithmetic process. For example If the cost of producing a product say ₹ 200/-, then we have to refer material, labour and expenses accounting and arrive the above cost as follows:

Material	₹	100
Labour	₹	40
Expenses	₹	60
Total	₹	200

Finding out the breakup of the total cost from the recorded data is a daily process. That is why it is called arithmetic process/daily routine. In this process we are classifying the recorded costs and summarizing at each element and total is called technique.



**Cost Accountancy:** Cost Accountancy is defined as '*the application of Costing and Cost Accounting principles, methods and techniques to the science, art and practice of cost control and the ascertainment of profitability*'. It includes the presentation of information derived there from for the purposes of managerial decision making. Thus, Cost Accountancy is the science, art and practice of a Cost Accountant.

- (a) It is a **science** because it is a systematic body of knowledge having certain principles which a cost accountant should possess for proper discharge of his responsibilities.
- (b) It is an **art** as it requires the ability and skill with which a Cost Accountant is able to apply the principles of Cost Accountancy to various managerial problems.
- (c) **Practice** includes the continuous efforts of a Cost Accountant in the field of Cost Accountancy.

Such efforts of a Cost Accountant also include the presentation of information for the purpose of managerial decision making and keeping statistical records.

### Objectives of Cost Accounting

The following are the main objectives of Cost Accounting :-

- (a) To ascertain the Costs under different situations using different techniques and systems of costing
- (b) To determine the selling prices under different circumstances
- (c) To determine and control efficiency by setting standards for Materials, Labour and Overheads
- (d) To determine the value of closing inventory for preparing financial statements of the concern
- (e) To provide a basis for operating policies which may be determination of Cost Volume relationship, whether to close or operate at a loss, whether to manufacture or buy from market, whether to continue the existing method of production or to replace it by a more improved method of production....etc.
- (f) To achieve real and permanent reduction in the unit cost of goods manufactured or services rendered without impairing their suitability for the use intended or diminution in the quality of the product.

### Scope of Cost Accountancy

The scope of Cost Accountancy is very wide and includes the following:-

- (a) **Cost Ascertainment:** The main objective of Cost Accounting is to find out the Cost of product / services rendered with reasonable degree of accuracy.
- (b) **Cost Accounting:** It is the process of Accounting for Cost which begins with recording of expenditure and ends with preparation of statistical data.
- (c) **Analysis of Cost:** It is the process of locating the factors responsible for difference in actual cost from the budgeted costs and fixing up of responsibility for differences in cost. It provides better cost management and helps in taking strategic decisions.
- (d) **Cost Control:** It is the process of regulating the action so as to keep the element of cost within the set parameters.
- (e) **Cost Reports:** This is the ultimate function of Cost Accounting. These reports are primarily prepared for use by the management at different levels. Cost reports helps in planning and control, performance appraisal and managerial decision making.
- (f) **Cost Audit:** Cost Audit is the verification of correctness of Cost Accounts and check on the adherence to the Cost Accounting plan. Its purpose is not only to ensure the arithmetic accuracy of cost records but also to see the principles and rules have been applied correctly.



To appreciate fully the objectives and scope of Cost Accounting, it would be useful to examine the position of Cost Accounting in the broader field of general accounting and other sciences. i.e Financial Accounting, Management Accounting, Engineering and Service Industry.

**Financial Accounting and Cost Accounting:** Financial Accounting is primarily concerned with the preparation of financial statements, which summarise the results of operations for selected period of time and show the financial position of the company at particular dates. In other words Financial Accounting reports on the resources available (Balance Sheet) and what has been accomplished with these resources (Profit and Loss Account). Financial Accounting is mainly concerned with requirements of creditors, shareholders, government, prospective investors and persons outside the management. Financial Accounting is mostly concerned with external reporting.

Cost Accounting, as the name implies, is primarily concerned with determination of cost of something, which may be a product, service, a process or an operation according to costing objective of management. A Cost Accountant is primarily charged with the responsibility of providing cost data for whatever purposes they may be required for.

The **main differences** between Financial and Cost Accounting are as follows:

<b>Financial Accounting</b>	<b>Cost Accounting</b>
(a) It provides the information about the business in a general way. i.e. Profit and Loss Account, Balance Sheet of the business to owners and other outside partners.	(a) It provides information to the management for proper planning, operation, control and decision making.
(b) It classifies, records and analyses the transactions in a subjective manner, i.e. according to the nature of expense.	(b) It records the expenditure in an objective manner, i.e. according to the purpose for which the costs are incurred.
(c) It lays emphasis on recording aspect without attaching any importance to control.	(c) It provides a detailed system of control for materials, labour and overhead costs with the help of standard costing and budgetary control.
(d) It reports operating results and financial position usually at the end of the year.	(d) It gives information through cost reports to management as and when desired.
(e) The users of financial accounting statements are the various stakeholders i.e. shareholders, creditors, financial institutions, banks, government and its various agencies and regulators.	(e) The users of cost accounting information are generally internal management, officials and senior executives of the company.
(f) Generally the financial statements are prepared periodically, for example, quarterly, half-yearly and yearly.	(f) The cost reports and statements are prepared as and when required by the management.
(g) There are standard formats used for presentation of financial information.	(g) There are no such standard formats used for presentation of cost accounting information.
(h) Financial Accounts are accounts of the whole business. They are independent in nature.	(h) Cost Accounting is only a part of the financial accounts and discloses profit or loss of each product, job or service.
(i) Financial Accounts records all the commercial transactions of the business and include all expenses i.e Manufacturing, Office, Selling etc.	(i) Cost Accounting relates to transactions connected with Manufacturing of goods and services, means expenses which enter into production.
(j) Financial Accounts are concerned with external transactions i.e. transactions between business concern and third party.	(j) Cost Accounts are concerned with internal transactions, which do not involve any cash payment or receipt.



(k) Only transactions which can be measured in monetary terms are recorded.	(k) Non-Monetary information likes No of Units / Hours etc are used.
(l) Financial Accounting deals with actual figures and facts only.	(l) Cost Accounting deals with partly facts and figures and partly estimates / standards.
(m) Financial Accounting do not provide information on efficiencies of various workers/ Plant & Machinery.	(m) Cost Accounts provide valuable information on the efficiencies of employees and Plant & Machinery.
(n) Stocks are valued at Cost or Market price whichever is lower.	(n) Stocks are valued at Cost only.
(o) Financial Accounting is a positive science as it is subject to legal rigidity with regarding to preparation of financial statements.	(o) Cost Accounting is not only positive science but also normative because it includes techniques of budgetary control and standard costing.
(p) These accounts are kept in such away to meet the requirements of Companies Act 2013 as per Sec 128 & Income Tax Act, 1961 Sec 44AA.	(p) Generally Cost Accounts are kept voluntarily to meet the requirements of the management, only in some industries Cost Accounting records are kept as per the Companies Act.

### Cost Accounting and Management Accounting

Management Accounting is primarily concerned with management. It involves application of appropriate techniques and concepts, which help management in establishing a plan for reasonable economic objective. It helps in making rational decisions for accomplishment of these objectives. Any workable concept or techniques whether it is drawn from Cost Accounting, Financial Accounting, Economics, Mathematics and Statistics, can be used in Management Accountancy. The data used in Management Accountancy should satisfy only one broad test. It should serve the purpose that it is intended for. A Management Accountant accumulates, summarizes and analysis the available data and presents it in relation to specific problems, decisions and day-to-day task of management. A Management Accountant reviews all the decisions and analysis from management's point of view to determine how these decisions and analysis contribute to overall organizational objectives. A Management Accountant judges the relevance and adequacy of available data from management's point of view.

The scope of Management Accounting is broader than the scope of Cost Accountancy. In Cost Accounting, primary emphasis is on cost and it deals with its collection analysis relevance interpretation and presentation for various problems of management. Management Accountancy utilizes the principles and practices of Financial Accounting and Cost Accounting in addition to other management techniques for efficient operations of a company. It widely uses different techniques from various branches of knowledge like Statistics, Mathematics, Economics, Laws and Psychology to assist the management in its task of maximising profits or minimising losses. The main thrust in Management Accountancy is towards determining policy and formulating plans to achieve desired objective of management. Management Accounting makes corporate planning and strategy effective.

From the above discussion we may conclude that the Cost Accounting and Management Accounting are interdependent, greatly related and inseparable.

### Advantages of Cost Accounting

Cost Accounting has manifold advantages, a summary of which is given below. It is not suggested that having installed a system of Cost Accounting, a concern will expect to derive all the benefits stated here, the nature and the extent of the advantages obtained will depend upon the type, adequacy and efficiency of the cost system installed and the extent to which the various levels of management are prepared to accept and act upon the advice rendered by the cost system.



The Cost Accounting System has the following advantages:-

- (i) A cost system reveals unprofitable activities, losses or inefficiencies occurring in any form such as
  - (a) Wastage of man power, idle time and lost time.
  - (b) Wastage of material in the form of spoilage, excessive scrap etc., and
  - (c) Wastage of resources, e.g. inadequate utilization of plant, machinery and other facilities.
- (ii) Cost Accounting locates the exact causes for decrease or increase in the profit or loss of the business. It identifies the unprofitable products or product lines so that these may be eliminated or alternative measures may be taken.
- (iii) Cost Accounts furnish suitable data and information to the management to serve as guides in making decisions involving financial considerations.
- (iv) Cost Accounting is useful for price fixation purposes. Although sale price is generally related more to economic conditions prevailing in the market than to cost, the latter serves as a guide to test the adequacy of selling prices.
- (v) With the application of Standard Costing and Budgetary Control methods, the optimum level of efficiency is set.
- (vi) Cost comparison helps in cost control. Comparison may be period to period, of the figures in respect of the same unit or factory or of several units in an industry by employing Uniform Costs and Inter- Firm Comparison methods. Comparison may be made in respect of cost of jobs, process or cost centres.
- (vii) A cost system provides ready figures for use by the Government, wage tribunals and boards, and labour and trade unions.
- (viii) When a concern is not working to full capacity due to various reasons such as shortage of demands or bottlenecks in production, the cost of idle capacity can readily worked out and revealed to the management.
- (ix) Introduction of a cost reduction programme combined with operations research and value analysis techniques leads to economy.
- (x) Marginal Costing is employed for suggesting courses of action to be taken. It is a useful tool for the management for making decisions.
- (xi) Determination of cost centres or responsibility centres to meet the needs of a Cost Accounting system, ensures that the organizational structure of the concern has been properly laid responsibility can be properly defined and fixed on individuals.
- (xii) Perpetual inventory system which includes a procedure for continuous stock taking is an essential feature of a cost system.
- (xiii) The operation of a system of cost audit in the organization prevents manipulation and fraud and assists in furnishing correct and reliable cost data to the management as well as to outside parties like shareholders, the consumers and the Government.

### **Limitations of Cost Accounting system**

Like any other system of accounting, Cost Accountancy is not an exact science but an art which has developed through theories and accounting practices based on reasoning and commonsense. Many of the theories cannot be proved nor can they be disproved. They grownup in course of time to become conventions and accepted principles of Cost Accounting. These principles are by no means static, they are changing from day to day and what is correct today may not hold true in the circumstances tomorrow.



Large number of Conventions, Estimates and Flexible factors: No cost can be said to be exact as they incorporate a large number of conventions, estimations and flexible factors such as :-

- (i) Classification of costs into its elements.
- (ii) Materials issue pricing based on average or standard costs.
- (iii) Apportionment of overhead expenses and their allocation to cost units/centres.
- (iv) Arbitrary allocation of joint costs.
- (v) Division of overheads into fixed and variable.
- (vi) Maintenance of Cost Accounting system appears to be expensive since the cost analysis, allocation and absorption of overheads etc. require considerable amount of additional work causing additional expenditure.
- (vii) Since the results shown by the financial accounts differ from those shown by the cost accounts, there is a need for preparing reconciliation statements for verification of accuracy.

Cost Accounting lacks the uniform procedures and formats in preparing the cost information of a product/ service. Keeping in view this limitation, all Cost Accounting results can be taken as mere estimates.

### **Installation of Cost System or Cost Accounting System**

From what has been stated in the preceding sections, it will be seen that there cannot be a readymade cost system suitable for a business. Such system has to be specially designed for an undertaking to meet its specific needs. Before installing a cost system proper care should be taken to study and taken into account all the aspects involved as otherwise the system will be a misfit and full advantages will not be realized from it. The following points should be looked into and the prerequisites satisfied before installing a cost system:-

- (i) The nature, method and stages of production, the number of varieties and the quantity of each product and such other technical aspects should be examined. It is to be seen how complex or how simple the production methods are and what is the degree of control exercised over them.
- (ii) The size, layout and organisation of the factory should be studied.
- (iii) The methods of purchase, receipt, storage and issue of materials should be examined and modified wherever considered necessary.
- (iv) The wage payment methods should be studied.
- (v) The requirements of the management and the policy adopted by them towards cost control should be kept in view.
- (vi) The cost of the system to be installed should be considered. It is needless to emphasize that the installation and operation of system should be economic.
- (vii) The system should be simple and easy to operate.
- (viii) The system can be effectively run if it is appropriate and properly suited to the organisation.
- (ix) Forms and records of original entry should be so designed as to involve minimum clerical work and expenditure.
- (x) The system should be so designed that cost control can be effectively exercised.
- (xi) The system should incorporate suitable procedure for reporting to the various levels of management. This should be based on the principles of exception.



### Requisites of a good Cost Accounting System

There are certain essential features which a good Cost Accounting System should possess. These features are discussed below.

- (i) The cost accounting system should be simple and practical. It should be able to meet the requirements of the organisation.
- (ii) The data and information used by the cost accounting system should be authentic and accurate enough to present accurate reporting in order to facilitate the management for taking right decisions.
- (iii) There is a need for uniformity and consistency in classifying, treating and reporting cost data and information so that it can facilitate comparability of the results of the system.
- (iv) With a view to ensuring clarity of the results there should be integration of the cost accounting system with financial accounting, operation research, statistics, taxation etc.
- (v) The cost accounting system should have enough flexibility in order to accommodate necessary amendments and modifications for the purpose of incorporating changes in technical, regulatory and other requirements.
- (vi) The management should be satisfied with the implementation of cost accounting system that facilitates the management in taking strategic business decisions.

## 1.2 COST OBJECTS, COST CENTERS AND COST UNITS – ELEMENTS OF COST

**Cost: Cost is a measurement, in monetary terms, of the amount of resources used for the purpose of production of goods or rendering services.**

Cost in simple, words, means the total of all expenses. Cost is also defined **as the amount of expenditure (actual or notional) incurred on or attributable to a given thing or to ascertain the cost of a given thing.** Thus it is that which is given or in sacrificed to obtain something. The cost of an article consists of actual outgoings or ascertained charges incurred in its production and sale. Cost is a generic term and it is always advisable to qualify the word cost to show exactly what it meant, e.g., prime cost, factory cost, etc. Cost is also different from value as cost is measured in terms of money whereas value in terms of usefulness or utility of an article.

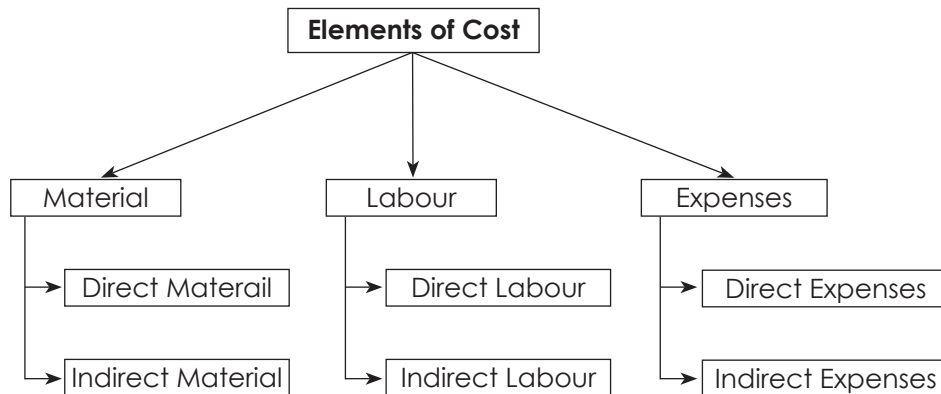

Direct Material + Direct Labour + Direct Expenses = Prime Cost

Indirect Material+ Indirect Labour + Indirect Expenses = Overheads





### Direct Material Cost

Direct material cost can be defined as **'The Cost of material which can be attributed to a cost object in an economically feasible way'**. Direct materials are those materials which can be identified in the product and can be conveniently measured and directly charged to the product. Thus, these materials directly enter the product and form a part of the finished product. For example, timber in furniture making, cloth in dress making, bricks in building a house. The following are normally classified as direct materials :-

- (i) All raw materials, like jute in the manufacture of gunny bags, pig iron in foundry and fruits in canning industry
- (ii) Materials specifically purchased for a specific job, process or order, like glue for book binding, starch powder for dressing yarn
- (iii) Parts or components purchased or produced, like batteries for transistor-radios
- (iv) Primary packing materials like cartons, wrappings, card-board boxes, etc.

### Indirect Material Cost

Indirect materials are those materials which do not normally form a part of the finished product. It has been defined as "materials which cannot be allocated but which can be apportioned to or absorbed by cost centres or cost units". These are:

- (i) Stores used in maintenance of machinery, buildings, etc., like lubricants, cotton waste, bricks and cements
- (ii) Stores used by the service departments, i.e., non-productive departments like Power House, Boiler House and Canteen, etc., and
- (iii) Materials which due to their cost being small, are not considered worthwhile to be treated as direct materials.

### Direct Labour / Employee Cost

The cost of employees can be attributed to a cost object in an economically feasible way. In simple words, it is that labour which can be conveniently identified or attributed wholly to a particular job, product or process or expended in converting raw materials into finished goods. Wages of such labour are known as direct wages. Thus it includes payment made to the following groups of labour:

- (i) Labour engaged on the actual production of the product or in carrying out of an operation or process
- (ii) Labour engaged in adding the manufacture by way of supervision, maintenance, tool setting, transportation of material etc.
- (iii) Inspectors, analysts etc., specially required for such production

### Indirect Labour/ Employee Cost

The labour / employee cost cannot be directly attributed to a particular cost object. The wages of that labour which cannot be allocated but which can be apportioned to or absorbed by cost centres or cost units is known as Indirect Labour. Example of such labour are: charge-hands and supervisors; maintenance workers; men employed in service departments, material handling and internal transport; apprentices, trainees and instructors; clerical staff and labour employed in time office and security office.

### Direct or Chargeable Expenses

Direct expenses are expenses relating to manufacture of a product or rendering a service which can be identified or linked with the cost object other than direct material cost and direct employee



cost. Direct expenses include all expenditure other than direct material or direct labour that is specifically incurred for a particular product or process. Such expenses are charged directly to the particular cost account concerned as part of the prime cost. Examples of direct expenses are: (i) GST; (ii) Royalty; (iii) Architect or Supervisor's fees; (iv) Cost of rectifying defective work; (v) Travelling expenses to the city; (vi) Experimental expenses of pilot projects; (vii) Expenses of designing or drawings of patterns or models; (viii) Repairs and maintenance of plant obtained on hire; and (ix) Hire of special equipment obtained for a contract.

### **Overhead**

Overheads comprise of indirect materials, indirect employee cost and indirect expenses which are not directly identifiable or allocable to a cost object. Overheads may be defined as the aggregate of the cost of indirect material, indirect labour and such other expenses including services as cannot conveniently be charged directly to specific cost units. Thus overheads are all expenses other than direct expenses. In general terms, overheads comprise all expenses incurred for or in connection with, the general organization of the whole or part of the undertaking, i.e., the cost of operating supplies and services used by the undertaking and includes the maintenance of capital assets.

### **Prime Cost**

The aggregate of Direct Material, Direct Labour and Direct Expenses is called Prime Cost. Generally it constitutes 50% to 80% of the total cost of the product, as such, as it is primary to the cost of the product and called Prime Cost.

### **Cost Object**

Cost object is the technical name for a product or a service, a project, a department or any activity to which a cost relates. Therefore the term cost should always be linked with a cost object to be more meaningful. Establishing a relevant cost object is very crucial for a sound costing system. The Cost object could be defined broadly or narrowly. At a broader level a cost object may be named as a **Cost Centre**, where as at a lowermost level it may be called as a **Cost Unit**.

### **Cost Driver**

CIMA terminology defines a Cost Driver as "the factor influencing the level of cost, often used in the context of ABC to denote the factor which links activity resource consumption to produce outputs, for example, the number of purchase orders would be a Cost Driver for procurement cost". In other words, we can say that, the Cost Driver is an activity which is responsible for cost incurrence. An activity may be an event, unit of work etc. Examples of the Cost Drivers are (i) number of machine set-ups, (ii) number of purchase orders, (iii) hours spent on product inspection, (iv) number of tests performed etc.

### **Cost Centre**

CIMA defines a cost centre as "a location, a person, or an item of equipment (or a group of them) in or connected with an undertaking, in relation to which costs ascertained and used for the purpose of cost control". The determination of suitable cost centres as well as analysis of cost under cost centres is very helpful for periodical comparison and control of cost. In order to obtain the cost of product or service, expenses should be suitably segregated to cost centre. The manager of a cost centre is held responsible for control of cost of his cost centre. The selection of suitable cost centres or cost units for which costs are to be ascertained in an undertaking depends upon a number of factors such as organization of a factory, condition of incidence of cost, availability of information, requirements of costing and management policy regarding selecting a method from various choices. Cost centre may be production cost centres operating cost centres or process cost centres depending upon the situation and classification.

Cost centres are of two types-Personal and Impersonal Cost Centre. A personal cost centre consists of person or group of persons. An impersonal cost centre consists of a location or item of equipment or group of equipments.



In a manufacturing concern, the cost centres generally follow the pattern or layout of the departments or sections of the factory and accordingly, there are two main types of cost centres as below :-

- (i) **Production Cost Centre:** These centres are engaged in production work i.e engaged in converting the raw material into finished product, for example Machine shop, welding shops...etc
- (ii) **Service Cost Centre:** These centres are ancillary to and render service to production cost centres, for example Plant Maintenance, Administration...etc

The number of cost centres and the size of each vary from one undertaking to another and are dependent upon the expenditure involved and the requirements of the management for the purpose of control.

### Responsibility Centre

A responsibility centre in Cost Accounting denotes a segment of a business organization for the activities of which responsibility is assigned to a specific person. Thus a factory may be split into a number of centres and a supervisor is assigned with the responsibility of each centre. All costs relating to the centre are collected and the Manager responsible for such a cost centres judged by reference to the activity levels achieved in relation to costs. Even an individual machine may be treated as responsibility centre for cost control and cost reduction.

### Profit Centre/Investment Centre

Profit centre is a segment of a business that is responsible for all the activities involved in the production and sales of products, systems and services. Thus a profit centre encompasses both costs that it incurs and revenue that it generates. Profit centres are created to delegate responsibility to individuals and measure their performance. In the concept of responsibility accounting, profit centres are sometimes also responsible for the investment made for the centre. The profit is related to the invested capital. Such a profit centre may also be termed as investment centre.

### Cost Unit

Cost Unit is a device for the purpose of breaking up or separating costs into smaller sub divisions attributable to products or services. *Cost unit can be defined as a 'Unit of product or service in relation to which costs are ascertained'*. The cost unit is the narrowest possible level of cost object.

It is the unit of quantity of product, service of time (or combination of these) in relation to which costs may be ascertained or expressed. We may, for instance, determine service cost per tonne of steel, per tonne-kilometre of a transport service or per machine hour. Sometimes, a single order or contract constitutes a cost unit which is known as a job. A batch which consists of a group of identical items and maintains its identity through one or more stages or production may also be taken as a cost unit.

A few examples of cost units are given below:

Industry / Product	Cost Unit
Automobile	Number of vehicles
Cable	Metres / kilometres
Cement	Tonne
Chemicals / Fertilizers	Litre / Kilogram / tonne
Gas	Cubic Metre
Power - Electricity	Kilowatt Hour
Transport	Tonne-Kilometre, Passenger-Kilometre
Hospital	Patient Day
Hotel	Bed Night



Education	Student year
Telecom	Number of Calls
BPO Service	Accounts handled
Professional Service	Chargeable Hours

### Cost Allocation

When items of cost are identifiable directly with some products or departments such costs are charged to such cost centres. This process is known as cost allocation. Wages paid to workers of service department can be allocated to the particular department. Indirect materials used by a particular department can also be allocated to the department. Cost allocation calls for two basic factors - (i) Concerned department/product should have caused the cost to be incurred, and (ii) exact amount of cost should be computable.

### Cost Apportionment

When items of cost cannot be directly charged to or accurately identifiable with any cost centres, they are prorated or distributed amongst the cost centres on some predetermined basis. This method is known as cost apportionment. Thus we see that items of indirect costs residual to the process of cost allocation are covered by cost apportionment. The predetermination of suitable basis of apportionment is very important and usually following principles are adopted - (i) Service or use (ii) Survey method (iii) Ability to bear. The basis ultimately adopted should ensure an equitable share of common expenses for the cost centres and the basis once adopted should be reviewed at periodic intervals to improve upon the accuracy of apportionment.

### Cost Absorption

Ultimately the indirect costs or overhead as they are commonly known, will have to be distributed over the final products so that the charge is complete. This process is known as cost absorption, meaning thereby that the costs absorbed by the production during the period. Usually any of the following methods are adopted for cost absorption - (i) Direct Material Cost Percentage (ii) Direct Labour Cost Percentage (iii) Prime Cost Percentage (iv) Direct Labour Hour Rate Method (v) Machine Hour Rate, etc. The basis should be selected after careful maximum accuracy of Cost Distribution to various production units. The basis should be reviewed periodically and corrective action whatever needed should be taken for improving upon the accuracy of the absorption.

### Conversion Cost

This term is defined as the sum of direct wages, direct expenses and overhead costs of converting raw material to the finished products or converting a material from one stage of production to another stage. In other words, it means the total cost of producing an article less the cost of direct materials used. The cost of indirect materials and consumable stores are included in such cost. The compilation of conversion cost is useful in a number of cases. Where cost of direct materials is of fluctuating nature, conversion cost is used to cost control purpose or for any other decision making. In contracts/jobs where raw materials are on account of the buyers conversion cost takes the place of total cost in the books of the producer. Periodic comparison/review of the conversion cost may give sufficient insight as to the level of efficiency with which the production unit is operating.

### Cost Control

Cost Control is defined as the regulation by executive action of the costs of operating an undertaking, particularly where such action is guided by Cost Accounting. Cost control involves the following steps and covers the various facets of the management:

**Planning:** First step in cost control is establishing plans / targets. The plan/target may be in the form of budgets, standards, estimates and even past actual may be expressed in physical as well as monetary terms. These serves as yardsticks by which the planned objective can be assessed.



**Communication:** The plan and the policy laid down by the management are made known to all those responsible for carrying them out. Communication is established in two directions; directives are issued by higher level of management to the lower level for compliance and the lower level executives report performances to the higher level.

**Motivation:** The plan is given effect to and performances starts. The performance is evaluated, costs are ascertained and information about results achieved are collected and reported. The fact that costs are being complied for measuring performances acts as a motivating force and makes individuals endeavor to better their performances.

**Appraisal and Reporting:** The actual performance is compared with the predetermined plan and variances, i.e deviations from the plan are analyzed as to their causes. The variances are reported to the proper level of management.

**Decision Making:** The variances are reviewed and decisions taken. Corrective actions and remedial measures or revision of the target, as required, are taken.

### **Advantages of Cost Control**

The advantages of cost control are mainly as follows

- (i) Achieving the expected return on capital employed by maximising or optimizing profit
- (ii) Increase in productivity of the available resources
- (iii) Reasonable price of the customers
- (iv) Continued employment and job opportunity for the workers
- (v) Economic use of limited resources of production
- (vi) Increased credit worthiness
- (vii) Prosperity and economic stability of the industry

### **Cost Reduction**

Profit is the resultant of two varying factors, viz., sales and cost. The wider the gap between these two factors, the larger is the profit. Thus, profit can be maximised either by increasing sales or by reducing costs. In a competition less market or in case of monopoly products, it may perhaps be possible to increase price to earn more profits and the need for reducing costs may not be felt. Such conditions cannot, however, exist paramount and when competition comes into play, it may not be possible to increase the sale price without having its adverse effect on the sale volume, which, in turn, reduces profit. Besides, increase in price of products has the ultimate effect of pushing up the raw material prices, wages of employees and other expenses- all of which tend to increase costs. In the long run, substitute products may come up in the market, resulting in loss of business. Avenues have, therefore, to be explored and method devised to cut down expenditure and thereby reduce the cost of products. In short, cost reduction would mean maximization of profits by reducing cost through economics and savings in costs of manufacture, administration, selling and distribution.

Cost reduction may be defined as the real and permanent reduction in the unit costs of goods manufactured or services rendered without impairing their suitability for the use intended. As will be seen from the definition, the reduction in costs should be real and permanent. Reductions due to windfalls, fortuitous receipts, changes in government policy like reduction in taxes or duties, or due to temporary measures taken for tiding over the financial difficulties do not strictly come under the purview of cost reduction. At the same time a programme of cost reduction should in no way affect the quality of the products nor should it lower the standards of performance of the business.

Broadly speaking reduction in cost per unit of production may be affected in two ways viz.,

- (i) By reducing expenditure, the volume of output remaining constant, and



- (ii) By increasing productivity, i.e., by increasing volume of output and the level of expenditure remains unchanged.

These aspects of cost reduction are closely linked and they act together - there may be a reduction in the expenditure and the same time, an increase in productivity.

**Cost Control vs. Cost Reduction:** Both Cost Reduction and Cost Control are efficient tools of management but their concepts and procedure are widely different. The differences are summarised below:

Cost Control	Cost Reduction
(a) Cost Control represents efforts made towards achieving target or goal.	(a) Cost Reduction represents the achievement in reduction of cost.
(b) The process of Cost Control is to set up a target, ascertain the actual performance and compare it with the target, investigate the variances, and take remedial measures.	(b) Cost Reduction is not concern with maintenance of performance according to standard.
(c) Cost Control assumes the existence of standards or norms which are not challenged.	(c) Cost Reduction assumes the existence of concealed potential savings in standards or norms which are therefore subjected to a constant challenge with a view to improvement by bringing out savings.
(d) Cost Control is a preventive function. Costs are optimized before they are incurred.	(d) Cost Reduction is a corrective function. It operates even when an efficient cost control system exists. There is room for reduction in the achieved costs under controlled conditions.
(e) Cost Control lacks dynamic approach.	(e) Cost Reduction is a continuous process of analysis by various methods of all the factors affecting costs, efforts and functions in an organization. The main stress is upon the why of a thing and the aim is to have continual economy in costs.

### 1.3 CLASSIFICATION OF COST

Types of costing have been designed to suit the needs of individual business conditions. The basic principles underlying all these methods are the same i.e. to collect and analyze the expenditure according to the elements of costs and to determine the cost of each Cost Centre and or Cost Unit. Classification of cost is the arrangement of items of costs in logical groups having regard to their nature or purpose. Items should be classified by one characteristic for a specific purpose without ambiguity. Scheme of classification should be such that every item of cost can be classified. In view of the above, cost classification may be explained as below:

As per Cost Accounting Standard 1 (CAS-1), the basis for cost classification is as follows:

- Nature of expense
- Relation to Object – Traceability
- Functions / Activities
- Behaviour – Fixed, Semi-variable or Variable
- Management decision making
- Production or Process
- Time Period

Classification of cost is the process of grouping the components of cost under a common designation on the basis of similarities of nature, attributes or relations. It is the process of identification of each item and the systematic placement of like items together according to their common features.

### (a) Classification by Nature of Expense

Costs should be gathered together in their natural grouping such as Material, Labour and Other Direct expenses. Items of costs differ on the basis of their nature. The elements of cost can be classified in the following three categories. 1. Material 2. Labour 3. Expenses

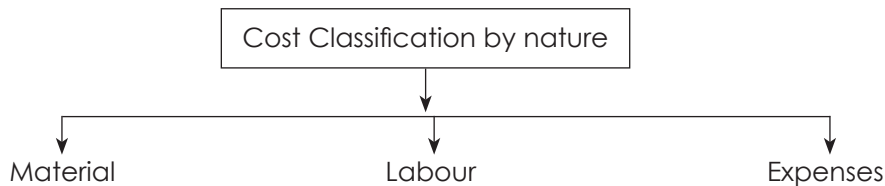

**Material Cost:** Material cost is the cost of material of any nature used for the purpose of production of a product or a service. It includes cost of materials, freight inwards, taxes & duties, insurance ...etc directly attributable to acquisition, but excluding the trade discounts, duty drawbacks and refunds on account of GST etc.

**Labour Cost:** Labour cost means the payment made to the employees, permanent or temporary for their services. Labour cost includes salaries and wages paid to permanent employees, temporary employees and also to the employees of the contractor. Here salaries and wages include all the benefits like provident fund, gratuity, ESI, overtime, incentives...etc

**Expenses:** Expenses are other than material cost or labour cost which are involved in an activity.

### (b) Classification by Relation to Cost Centre or Cost Unit

If expenditure can be allocated to a cost centre or cost object in an economically feasible way then it is called direct otherwise the cost component will be termed as indirect. According to this criteria for classification, material cost is divided into direct material cost and indirect material cost, Labour cost is divided into direct labour and indirect labour cost and expenses into direct expenses and indirect expenses. Indirect cost is also known as overhead.

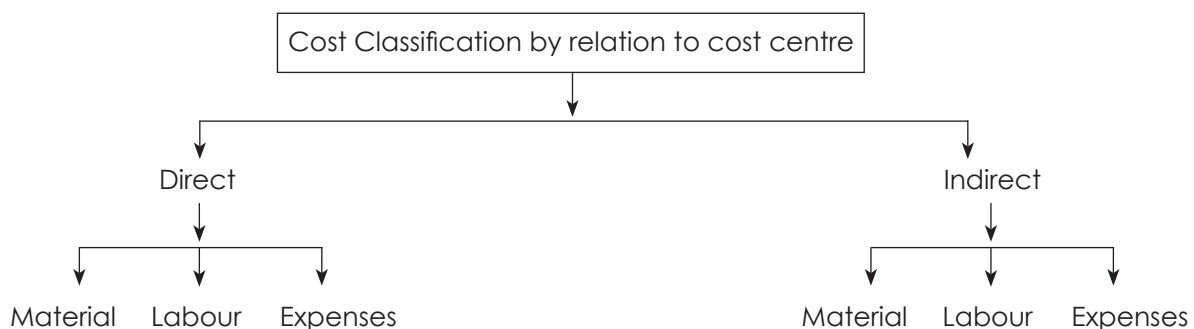

**Direct Material Cost:** Cost of material which can be directly allocated to a cost centre or a cost object in an economically feasible way.

**Direct labour Cost:** Cost of wages of those workers who are readily identified or linked with a cost centre or cost object.

**Direct Expenses:** Expenses other than direct material and direct labour which can be identified or linked with cost centre or cost object.

$$\text{Direct Material} + \text{Direct labour} + \text{Direct Expenses} = \text{Prime Cost}$$



**Indirect Material :** Cost of material which cannot be directly allocable to a particular cost centre or cost object.

**Indirect Labour :** Cost of wages of employees which are not directly allocable to a particular cost centre.

**Indirect expenses:** Expenses other than of the nature of material or labour and cannot be directly allocable to a particular cost centre.

$$\text{Indirect Material} + \text{Indirect Labour} + \text{Indirect Expenses} = \text{Overheads}$$

**(c) Classification by Functions**

A business enterprise performs a number of functions like manufacturing, selling, research...etc.

Costs may be required to be determined for each of these functions and on this basis functional costs may be classified into the following types:-

- (i) Production or Manufacturing Costs
- (ii) Administration Costs
- (iii) Selling & Distribution cost
- (iv) Research & Development costs

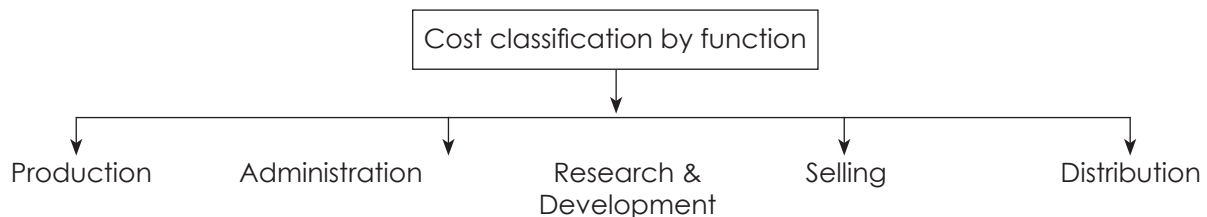

**(i) Production or Manufacturing Costs:** Production cost is the cost of all items involved in the production of a product or service. These refer to the costs of operating the manufacturing division of an undertaking and include all costs incurred by the factory from the receipt of raw materials and supply of labour and services until production is completed and the finished product is packed with the primary packing.

The followings are considered as Production or Manufacturing Costs:-

- (1) Direct Material
- (2) Direct Labour
- (3) Direct Expenses and
- (4) Factory overhead, i.e., aggregate of factory indirect material, indirect labour and indirect expenses.

Manufacturing cost can also be referred to as the aggregate of prime cost and factory overhead.

**(ii) Administration Costs:** Administration costs are expenses incurred for general management of an organization. These are in the nature of indirect costs and are also termed as administrative overheads. For understanding administration cost, it is necessary to know the scope of administrative function. Administrative function in any organization is primarily concerned with following activities :-

- (1) Formulation of policy





- (2) Directing the organization and
- (3) Controlling the operations of an organization. But administrative function will not include control activities concerned with production, selling and distribution and research and development.

Therefore, administration cost is the cost of administrative function, i.e., the cost of formulating policy, directing, organizing and controlling the operations of an undertaking (Administrative cost will include the cost of only those control operations which are not related to production, selling and distribution and research and development). In most of the cases, administration cost includes indirect expenses of following types:

- (1) Salaries of office staff, accountants, directors
- (2) Rent, rates and depreciation of office building
- (3) Postage, stationery and telephone
- (4) Office supplies and expenses
- (5) General administration expenses.

**(iii) Selling & Distribution Costs:** Selling costs are indirect costs related to selling of products or services and include all indirect costs in sales management for the organization. Distribution costs are the costs incurred in handling a product from the time it is completed in the works until it reaches the ultimate consumer.

Selling function includes activities directed to create and stimulate demand of company's product and secure orders. Distribution costs are incurred to make the saleable goods available in the hands of the customer.

Following are the examples of selling and distribution costs:

- (1) Salaries and commission of salesmen and sales managers
- (2) Expenses of advertisement, insurance
- (3) Rent, rates, depreciation and insurance of sales office and warehouses
- (4) Cost of insurance, freight, export, duty, packing, shipping, etc.,
- (5) Maintenance of Delivery vans

**(iv) Research & Development Costs:** Research & development costs are the cost for undertaking research to improve quality of a present product or improve process of manufacture, develop a new product, market research...etc. and commercialization thereof.

R&D Costs comprises of the following:-

- (1) Development of new product
- (2) Improvement of existing products
- (3) Finding new uses for known products
- (4) Solving technical problem arising in manufacture and application of products
- (5) Development cost includes the costs incurred for commercialization/implementation of research findings.

#### **Pre-Production Costs:**

These are costs incurred when a new factory is in the process of establishment, a new project is undertaken, or a new product line or product is taken up but there is no established or formal production to which such costs may be charged. Preproduction costs are normally treated as deferred revenue expenditure and charged to the costs of future production.

**(d) Classification based on Behaviour – Fixed, Semi-variable or Variable**

Costs are classified based on behaviour as fixed cost, variable cost and semi-variable cost depending upon response to the changes in the activity levels.

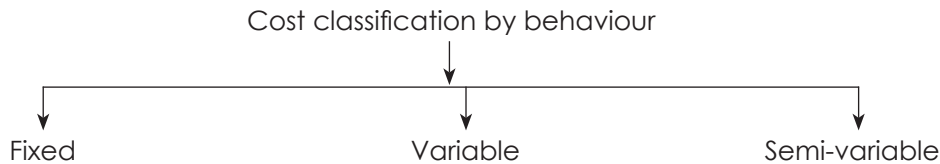

**Fixed Cost:** Fixed cost is the cost which does not vary with the change in the volume of activity in the short run. These costs are not affected by temporary fluctuation in activity of an enterprise. These are also known as period costs. Example: Rent, Depreciation...etc.

**Variable Cost:** Variable cost is the cost of elements which tends to directly vary with the volume of activity. Variable cost has two parts (i) Variable direct cost (ii) Variable indirect costs. Variable indirect costs are termed as variable overheads. Example: Direct labour, Outward Freight...etc.

**Semi-Variable Costs:** Semi variable costs contain both fixed and variable elements. They are partly affected by fluctuation in the level of activity. These are partly fixed and partly variable costs and vice versa. Example: Factory supervision, Maintenance...etc.

**(e) Classification based on Costs for Management Decision Making**

Ascertainment of cost is essential for making managerial decisions. On this basis costing may be classified into the following types.

**Marginal Costing:** Marginal Cost is the aggregate of variable costs, i.e. prime cost plus variable overhead. Marginal cost per unit is the change in the amount at any given volume of output by which the aggregate cost changes if the volume of output is increased or decreased by one unit. Marginal Costing system is based on the system of classification of costs into fixed and variable. The fixed costs are excluded and only the marginal costs, i.e. the variable costs are taken into consideration for determining the cost of products and the inventory of work-in-progress and completed products.

**Differential Cost:** Differential cost is the change in the cost due to change in activity from one level to another.

**Opportunity Cost:** Opportunity cost is the value of alternatives foregone by adopting a particular strategy or employing resources in specific manner. It is the return expected from an investment other than the present one. These refer to costs which result from the use or application of material, labour or other facilities in a particular manner which has been foregone due to not using the facilities in the manner originally planned. Resources (or input) like men, materials, plant and machinery, finance etc., when utilized in one particular way, yield a particular return (or output). If the same input is utilized in another way, yielding the same or a different return, the original return on the forsaken alternative that is no longer obtainable is the opportunity cost. For example, if fixed deposits in the bank are proposed to be withdrawn for financing project, the opportunity cost would be the loss of interest on the deposits. Similarly when a building leased out on rent to a party is got vacated for own purpose or a vacant space is not leased out but used internally, say, for expansion of the production programme, the rent so forgone is the opportunity cost.

**Replacement Cost:** Replacement cost is the cost of an asset in the current market for the purpose of replacement. Replacement cost is used for determining the optimum time of replacement of an equipment or machine in consideration of maintenance cost of the existing one and its productive capacity. This is the cost in the current market of replacing an asset. For example, when replacement cost of material or an asset is being considered, it means that the cost that would be incurred if the material or the asset was to be purchased at the current market price and not the cost, at which it was actually purchased earlier, should be taken into account.



**Relevant Costs:** Relevant costs are costs which are relevant for a specific purpose or situation. In the context of decision making, only those costs are relevant which are pertinent to the decision at hand. Since we are concerned with future costs only while making a decision, historical costs, unless they remain unchanged in the future period are irrelevant to the decision making process.

**Imputed Costs:** Imputed costs are hypothetical or notional costs, not involving cash outlay computed only for the purpose of decision making. In this respect, imputed costs are similar to opportunity costs. Interest on funds generated internally, payment for which is not actually made is an example of imputed cost. When alternative capital investment projects are being considered out of which one or more are to be financed from internal funds, it is necessary to take into account the imputed interest on own funds before a decision is arrived at.

**Sunk Costs:** Sunk costs are historical costs which are incurred i.e. sunk in the past and are not relevant to the particular decision making problem being considered. Sunk costs are those that have been incurred for a project and which will not be recovered if the project is terminated. While considering the replacement of a plant, the depreciated book value of the old asset is irrelevant as the amount is sunk cost which is to be written-off at the time of replacement.

**Normal Cost & Abnormal Cost:** Normal Cost is a cost that is normally incurred at a given level of output in the conditions in which that level of output is achieved. Abnormal Cost is an unusual and typical cost whose occurrence is usually irregular and unexpected and due to some abnormal situation of the production.

**Avoidable Costs & Unavoidable Costs:** Avoidable Costs are those which under given conditions of performance efficiency should not have been incurred. Unavoidable Costs which are inescapable costs, which are essentially to be incurred, within the limits or norms provided for. It is the cost that must be incurred under a programme of business restriction. It is fixed in nature and inescapable.

**Uniform Costing:** This is not a distinct system of costing. The term applies to the costing principles and procedures which are adopted in common by a number of undertakings which desire to have the benefits of a uniform system. The methods of Uniform Costing may be extended so as to be useful in inter-firm comparison.

**Engineered Cost:** Engineered Cost relates to an item where the input has an explicit physical relationship with the output. For instance in the manufacture of a product, there is a definite relationship between the units of raw material and labour time consumed and the amount of variable manufacturing overhead on the one hand and units of the products produced on the other. The input-output relationship can be established the form of standards by engineering analysis or by an analysis of the historical data. It should be noted that the variable costs are not engineered cost but some administration and selling expenses may be categorized as engineered cost.

**Out-of-Pocket Cost:** This is the portion of the cost associated with an activity that involve cash payment to other parties, as opposed to costs which do not require any cash outlay, such as depreciation and certain allocated costs. Out-of-Pocket Costs are very much relevant in the consideration of price fixation during trade recession or when a make-or-buy decision is to be made.

**Managed Cost:** Managed (Programmed or Discretionary) Costs all opposed to engineering costs, relate to such items where no accurate relationship between the amount spent on input and the output can be established and sometimes it is difficult to measure the output. Examples are advertisement cost, research and development costs, etc.,

**Common Costs:** These are costs which are incurred collectively for a number of cost centres and are required to be suitably apportioned for determining the cost of individual cost centres. Examples are: Combined purchase cost of several materials in one consignment, and overhead expenses incurred for the factory as a whole.

**Controllable and Non-Controllable Costs:** Controllable Cost is that cost which is subject to direct control at some level of managerial supervision. Non-controllable Cost is the cost which is not subject to control at any level of managerial supervision.

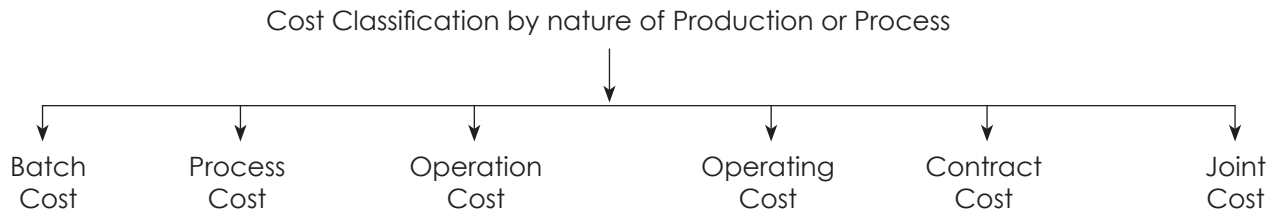
**(f) Classification by nature of Production or Process**

**Batch Costing:** Batch Costing is the aggregate cost related to a cost unit which consists of a group of similar articles which maintains its identity throughout one or more stages of production. In this method, the cost of a group of products is ascertained. The unit cost is a batch or group of identical products instead of a single job, order, or contract. This method is applicable to general engineering factories which produces components in convenient economical batches.

**Process Costing:** When the production process is such that goods are produced from a sequence of continuous or repetitive operations or processes, the cost incurred during a period is considered as Process Cost. The process cost per unit is derived by dividing the process cost by number of units produced in the process during the period. Process Costing is employed in industries where a continuous process of manufacturing is carried out. Costs are ascertained for a specified period of time by departments or process. Chemical industries, refineries, gas and electricity generating concerns may be quoted as examples of undertakings that employ process costing.

**Operation Cost:** Operation Cost is the cost of a specific operation involved in a production process or business activity. The cost unit in this method is the operation, instead of process. When the manufacturing method consists of a number of distinct operations, operation costing is suitable.

**Operating Cost:** Operating cost is the cost incurred in conducting a business activity. Operating cost refer to the cost of undertakings which do not manufacture any product but which provide services. Industries and establishments like power house, transport and travel agencies, hospitals, and schools, which undertake services rather than the manufacture of products, ascertain operating costs. The cost units used are Kilo Watt Hour (KWH), Passenger Kilo-meter and Bed in the hospital....etc. Operating costing method constitutes a distinct type of costing but it may also be classed as a variant of Process Cost since costs in this method are usually compiled for a specified period.

**Contract Costing:** Contract cost is the cost of contract with some terms and conditions between contractee and contractor. This method is used in undertakings, carrying out, building or constructional contracts like constructional engineering concerns, civil engineering contractors. The cost unit here is a contract, which may continue over more than one financial year.

**Joint Costs:** Joint costs are the common cost of facilities or services employed in the output of two or more simultaneously produced or otherwise closely related operations, commodities or services. When a production process is such that from a set of same input two or more distinguishably different products are produced together, products of greater importance are termed as Joint Products and products of minor importance are termed as By-products and the costs incurred prior to the point of separation are called Joint Costs. For example in petroleum industry petrol, diesel, kerosene, naphtha, tar is produced jointly in the refinery process.

**By-product Cost:** By-product Cost is the cost assigned to by-products till the split-off point.

### (g) Classification by Time

A cost item is related to a specific period of time and cost can be classified according to the system of assessment and specific purpose as indicated in the following ways :-

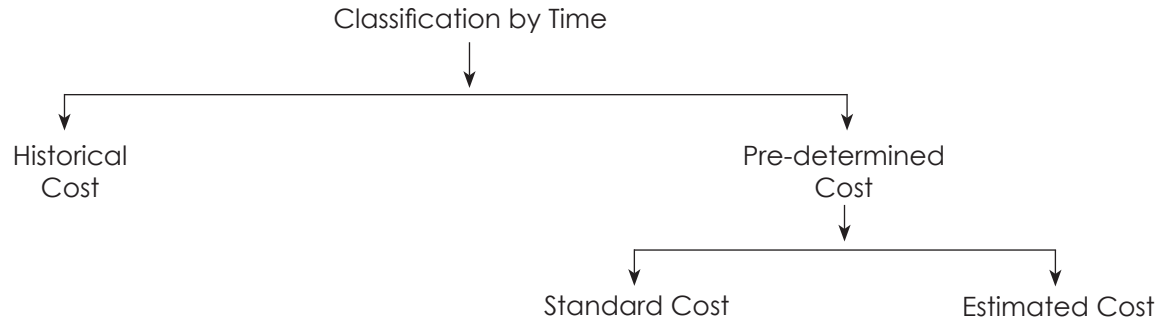

**Historical Costs:** Historical Costs are the actual costs of acquiring assets or producing goods or services. They are post-mortem costs ascertained after they have been incurred and they represent the cost of actual operational performance. Historical Costing follows a system of accounting to which all values are based on costs actually incurred as relevant from time to time.

**Predetermined Costs:** Pre-determined Costs for a product are computed in advance of production process, on the basis of a specification of all the factors affecting cost and cost data. Predetermined Costs may be either standard or estimated.

**Standard Costs:** A predetermined norm applies as a scale of reference for assessing actual cost, whether these are more or less. The Standard Cost serves as a basis of cost control and as a measure of productive efficiency, when ultimately posed with an actual cost. It provides management with a medium by which the effectiveness of current results is measured and responsibility of deviation placed. Standard Costs are used to compare the actual costs with the standard cost with a view to determine the variances, if any, and analyse the causes of variances and take proper measure to control them.

**Estimated Costs:** Estimated Costs of a product are prepared in advance prior to the performance of operations or even before the acceptance of sale orders. Estimated Cost is found with specific reference to product in question, and the activity levels of the plant. It has no link with actual and hence it is assumed to be less accurate than the Standard Cost.

#### Techniques of Costing

- A. Marginal Costing
- B. Standard Costing
- C. Budgetary Control
- D. Uniform Costing

#### A. Marginal costing

Marginal Costing is the ascertainment of marginal costs and of the effect on profit of changes in volume or type of output by differentiating between fixed costs and variable costs. Several other terms in use like Direct Costing, Contributory Costing, Variable Costing, Comparative Costing, Differential Costing and Incremental Costing are used more or less synonymously with Marginal Costing.

The term direct cost should not be confused with direct costing. In absorption costing, direct cost refers to the cost which is attributable to a cost centre of cost unit (e.g., direct labour, direct material and direct expenses including traceable fixed expenses, i.e., the fixed expense which are directly chargeable). In Direct Costing (or Marginal Costing), factory variable overhead is taken as a direct cost while in the Absorption Cost Method, it is Indirect Cost.



## **B. Standard Costing**

Standard Costing is defined as the preparation and use of standard cost, their comparison with actual costs and the measurement and analysis of variances to their causes and points of incidence. Standard Cost is a predetermined cost unit that is calculated from the management's standards of efficient operation and the relevant necessary expenditure. Standard Costs are useful for the cost estimation and price quotation and for indicating the suitable cost allowances for products, process and operations but they are effective tools for cost control only when compared with the actual costs of operation. The techniques of standard costing may be summarised as follows :-

- (i) Predetermination of technical data related to production. i.e., details of materials and labour operations required for each product, the quantum of inevitable losses, efficiencies expected, level of activity, etc.
- (ii) Predetermination of standard costs in full details under each element of cost, viz., labour, material and overhead.
- (iii) Comparison of the actual performance and costs with the standards and working out the variances, i.e., the differences between the actual and the standards.
- (iv) Analysis of the variances in order to determine the reasons for deviations of actuals from the standards.
- (v) Presentation of information to the appropriate level of management to enable suitable action (remedial measures or revision of the standard) being taken.

## **C. Budgetary Control**

Budgetary Control may be defined as the process of continuous comparison of actual costs and performance with the pre-established budgets in relation to the responsibilities of the executives to the specific budgets for the achievement of a target in accordance with the policy of the organisation and to provide a basis for revision of budget. Therefore, Budgetary Control involves mainly establishment of budgets, continuous comparison of actual with budgets for achievement of targets, revision of budgets in the light of changed circumstances.

The classification of budgets into various categories certainly helps to make the budgetary control more effective because the maximum use is made of the functional budgets. Functional Budgets over the goals to be attained by the functional executives and thus assume the greatest significance.

## **D. Uniform Costing**

Uniform Costing may be defined as the application and use of the same costing principles and procedures by different Organizations under the same management or on a common understanding between members of an association. It is thus not a separate technique or method. It simply denotes a situation in which a number of organizations may use the same costing principles in such a way as to produce costs which are of the maximum comparability. From such comparable costs valuable conclusions can be drawn. When the Uniform Costing is made use of by the different concerns the same management it helps to indicate the strengths and/or weaknesses of those concerns. By studying the findings, appropriate corrective steps may be taken to improve the overall efficiency of the organizations. When used by the member concerns of a trade association Uniform Costing helps to reduce expenditure on a comparative marketing, to determine and follow a uniform pricing policy, to exchange information between the members for comprised and improvement and so on.

Inter-firm Comparison as the name denotes means the techniques of evaluating the performances, efficiencies, deficiencies, costs and profits of similar nature of firms engaged in the same industry or business. It consists of exchange of information, voluntarily of course, concerning production, sales cost with various types of break-up, prices, profits, etc., among the firms who are interested or willing to make the device a success. The basic purposes of such comparison are to find out the work points in an organization and to improve the efficiency by taking appropriate measures to wipe out the weakness gradually over a period of time.



## 1.4 ROLE OF COST ACCOUNTANTS IN ORGANISATIONS

In today's business world all organisations irrespective of their size, nature of business, profitability etc. need a wide variety of cost information in making day-to-day operating decisions. The cost accountants collect, assimilate, collate, and analyse all financial information relating to the organisations. They consider many factors such as the cost of raw materials, labour, overheads etc. in order to plan and execute effective management information and control system, inventory control incorporating mathematical models, investment analysis, internal audit, cost audit, project management etc.

The cost accountants perform one of the most important roles in the entire organisations. They deal with the preparation of various reports for the knowledge and decision making by the senior management. Therefore, the companies must provide greater emphasis on the role of the cost accountants.

The role of the cost accountants in the organisations can be enumerated as follows:

- (i) to analyse various elements of cost of production/services such as material, labour, overhead expenses etc.
- (ii) to introduce appropriate costing methods in the organisation so as to facilitate management with the knowledge of cost of production/services for managerial decision making
- (iii) to determine the cost of the new product/service in order to facilitate management in arriving at the correct pricing decisions
- (iv) to determine the feasibility and profitability of the various project proposals considered by the management
- (v) to analyse variances against standard by reason to enable concerned department to initiate corrective action
- (vi) collection, collation of extraneous information for management to compare the company's performance with that of peers and the industry for better appreciation and decision-making.

## GLOSSARY

**Activity based Costing (ABC):** Activity based Costing is a system that focuses on activities as the fundamental cost objects and uses the cost of these activities for compiling the costs of products and other cost objects. The product cost is built up from the cost of the specific activities undertaken to manufacture it.

**Conversion Cost:** Conversion Cost is the cost of converting material input into semi-finished or finished products i.e. the cost incurred in additional direct materials, direct wages, direct expenses and absorbed overhead.

**Cost Absorption:** Cost Absorption is the process of charging to the cost units by means of rates.

**Cost Accountancy:** Cost Accountancy is the application of costing and cost accounting principles, methods and techniques to the science, art and practice of cost control and the ascertainment of profitability. It includes the presentation of information derived therefrom for the purpose of managerial decision making.

**Cost Accounting:** Cost Accounting is a process of accounting for cost which begins with the recording of income and expenditure or the bases on which they are calculated and ends with the preparation of periodical statements and reports for ascertaining and controlling costs.

**Cost Allocation:** Cost Allocation is that part of cost attribution which charges specific cost to a cost centre or cost unit.



**Cost Apportionment:** Cost Apportionment is that part of cost attribution which shares costs among two or more cost centres or cost units in proportion to the estimated benefit received.

**Cost Audit:** Cost Audit is the verification of correctness of cost accounts and check on the adherence to the cost accounting plan. Its purpose is not only to ensure the arithmetical accuracy of cost records but also to ensure that the principles and rules have been applied correctly.

**Cost Centre:** Cost Centre is a location, function or items of equipment in respect of which costs may be ascertained and related to cost units for control purposes.

**Cost Control:** Cost Control is the process of regulating the action so as to keep the element of cost within the set parameters.

**Cost Driver:** Cost Driver is the factor influencing the level of cost, often used in the context of ABC to denote the factor which links activity resource consumption to produce outputs, for example, the number of purchase orders would be a cost driver for procurement cost.

**Cost Management:** Cost Management is an application of management accounting concepts, methods of collections, analysis and presentation of data to provide the information needed to plan, monitor and control costs.

**Cost Object:** Cost Object is anything for which a separate measurement of cost is required. Cost object may be a product, a service, a project, a customer, a brand category, an activity, a department or a programme etc.

**Cost Reduction:** Cost Reduction is the achievement of real and permanent reduction in the unit cost of goods manufactured or services rendered without impairing their suitability for the use intended or diminution in the quality of the product.

**Cost Unit:** Cost Unit is a unit of product or service in relation to which costs are ascertained.

**Cost:** Cost is the amount of expenditure (actual or notional) incurred on or attributable to a specified article, product or activity.

**Costing:** Costing is the technique and process of ascertaining costs.

**Financial Accounting:** Financial Accounting is the organisation and presentation of a firm's accounts for information of the management as well as the various stakeholders.

**Investment Centre:** Investment Centre is a profit centre whose performance is measured by its return on capital employed.

**Management Accounting:** Management Accounting is the application of the principles of accounting and financial management to create, protect, preserve and increase value for the stakeholders of for-profit and not-for-profit enterprises in the public and private sectors.

**Profit Centre:** Profit Centre is a part of business accountable for costs and revenues.

**Responsibility Centre:** Responsibility Centre is a unit or function of an organisation headed by a manager having direct responsibility for its performance.

**Revenue Centre:** Revenue Centre is a responsibility centre which is accountable for generation of revenue for the organisation.

**Sunk Cost:** Sunk Cost is the cost incurred in purchasing a capital asset. Depreciation is in the nature of a recovery of sunk cost due to the past management decision.





**SELF EXAMINATION QUESTIONS:**

1. Define profit centre.
2. State the objective of Cost Accounting.
3. Cost may be classified in a variety of ways according to their nature and the information needs of the management" Discuss.
4. State the benefits accrue out of Cost Accounting.
5. What is meant by Cost Centre?
6. What are the essential features of a good Cost Accounting system?
7. What are the factors to be considered before installation of a Cost Accounting system?
8. Discuss the roles of a Cost Accountant in an organisation.
9. State the method of costing followed by each of the following industries?
  - (a) Crane manufacturing
  - (b) Bridge construction
  - (c) Road-roller manufacturing
  - (d) Iron and steel manufacturing
  - (e) Power generation company
  - (f) Transport service
  - (g) Hospitality service
10. Write short notes on the following:
  - (a) Out of Pocket Cost.
  - (b) Sunk Cost
  - (c) Opportunity Cost
  - (d) Imputed Costs

**Multiple Choice Questions:**

1. Batch Costing is suitable for-
  - A. Sugar Industry
  - B. Chemical Industry
  - C. Pharma Industry
  - D. Oil Industry
2. Joint Cost is suitable for-
  - A. Infrastructure Industry
  - B. Ornament Industry.
  - C. Oil Industry
  - D. Fertilizer Industry



3. Cost units of Hospital Industry is-
  - A. Tonne
  - B. Student per year
  - C. Kilowatt Hour
  - D. Patient Day
  
4. Cost units of Automobile Industry is-
  - A. Cubic meter
  - B. Bed Night
  - C. Number of Call
  - D. Number of vehicle
  
5. Depreciation is a example of-
  - A. Fixed Cost
  - B. Variable Cost
  - C. Semi Variable Cost
  - D. None of these
  
6. Process costing method is suitable for:
  - A. Steel industry
  - B. Crane manufacturing organization
  - C. Road roller manufacturing company
  - D. Transport industry
  - E. None of the above
  
7. Which of the following classification is meant for distinction between direct cost and indirect cost?
  - A. Function
  - B. Element
  - C. Variability
  - D. Controllability
  - E. None of the above
  
8. Which of the following is applicable for Cost Control?
  - A. It is related with the future
  - B. It is a corrective function
  - C. It ends when the targets are achieved
  - D. It challenges the standards set
  - E. None of the above



9. ----- is anything for which a separate measurement of cost is required.
- A. Cost driver
  - B. Cost centre
  - C. Cost unit
  - D. Cost object
10. Ticket counter in a Metro station is an example of:
- A. Profit centre
  - B. Investment centre
  - C. Cost centre
  - D. Revenue centre
11. Which of the following is an example of functional classification of cost?
- A. Direct labour cost
  - B. Direct material cost
  - C. Factory overhead
  - D. Indirect material cost

[Ans: C, C, D, D, A, A, B, C, D, D, C]

**State whether the following statement is True (or) False:**

- 1. Differential Cost is the change in the cost due to change in activity from one level to another.
- 2. Cost unit of Hotel industry is student per year.
- 3. Multiple Costing is suitable for the banking Industry.
- 4. Direct Expenses are expenses related to manufacture of a product or rendering of services.
- 5. Profit is result of two varying factors sales sales and variable cost.
- 6. Cost Accounting is not required for a non-profit organisation such as medical hospital.
- 7. Cost reduction and cost control means the same thing.
- 8. Notional costs and imputed costs means the same thing.
- 9. Cost Accounting is a branch of Financial Accounting.
- 10. Opportunity cost is recorded in the costing books of accounts.
- 11. Conversion costs are recorded as direct cost.
- 12. All store items such as lubricant oil, cotton waste etc. is regarded as direct material cost

[Ans: T, F, F, T, F, F, F, T, F, F, F, F]



**Fill in the blanks:**

1. Differential cost is the change in the cost due to change in \_\_\_\_\_ from one level to another.
2. Management accounting is primarily concerned with \_\_\_\_\_.
3. In Cost Accounting stock are valued at \_\_\_\_\_ only.
4. Profit is the resultant of two varying factors viz \_\_\_\_\_ and \_\_\_\_\_.
5. \_\_\_\_\_ cost are historical costs which are incurred in the past.
6. A responsibility centre in which a manager is responsible for costs only is called \_\_\_\_\_.
7. \_\_\_\_\_ costs are not considered for decision making because all past costs are not relevant.
8. \_\_\_\_\_ expenses are not included in the cost sheet.

[Ans: (1) activity; (2) management; (3) cost; (4) sales, cost; (5) sunk;  
(6) Cost Centre; (7) Sunk; (8) Notional.

**Match the following:**

1	Historical Cost	A	Specific Situation
2	Opportunity Cost	B	Student year
3	Relevant Cost	C	Imputed Cost
4	Cost unit for education	D	Value of alternative foregone
5	Notional Cost	E	Sunk cost

[Ans: (1) - (E); (2) - (D); (3) - (A); (4) - (B); (5) - (C).



## Study Note - 2

### COST ASCERTAINMENT - ELEMENTS OF COST

#### This Study Note includes

- 2.1 Material Costs (CAS - 6)
- 2.2 Employee Costs (CAS - 7)
- 2.3 Direct Expenses (CAS - 10)
- 2.4 Overheads (CAS - 3)

#### 2.1 MATERIAL COST (CAS-6)

Material is a substance (Physics term) that forms part of or composed of a finished product. i.e material refers to the commodities supplied to an undertaking for the purpose of consumption in the process of manufacturing or of rendering service or for transformation into products. The term 'Stores' is often used synonymously with materials, however, stores has a wider meaning and it covers not only raw materials consumed or utilised in production but also such other items as sundry supplies, maintenance stores, fabricated parts, components, tools, jigs, other items, consumables, lubricants.....etc. Finished and partly finished products are also often included under the term 'Stores'. Materials are also known as Inventory. The term Materials / Inventory covers not only raw materials but also components, work-in-progress and finished goods and scrap also.

Material cost is the significant constituent of the total cost of any product. It constitutes 40% to 80% of the total cost. The percentages may differ from industry to industry. But for manufacturing sector the material costs are of greatest significance. Inventory also constitutes a vital element in the Working Capital. So it is treated as equivalent to cash. Therefore the analysis and control on Material Cost is very important.

#### Objectives of Material Control System

*Material Control:* The function of ensuring that sufficient goods are retained in stock to meet all requirements without carrying unnecessarily large stocks.

The objectives of a system of material control are as following:-

- (a) To make continuous availability of materials so that there may be uninterrupted flow of materials for production. Production may not be held up for want of materials.
- (b) To purchase requisite quantity of materials to avoid locking up of working capital and to minimise risk of surplus and obsolete stores
- (c) To make purchase competitively and wisely at the most economical prices so that there may be reduction of material costs
- (d) To purchase proper quality of materials to have minimum possible wastage of materials
- (e) To serve as an information centre on the materials knowledge for prices, sources of supply, lead time, quality and specification



(f) Study of Material can be better explained as follows:

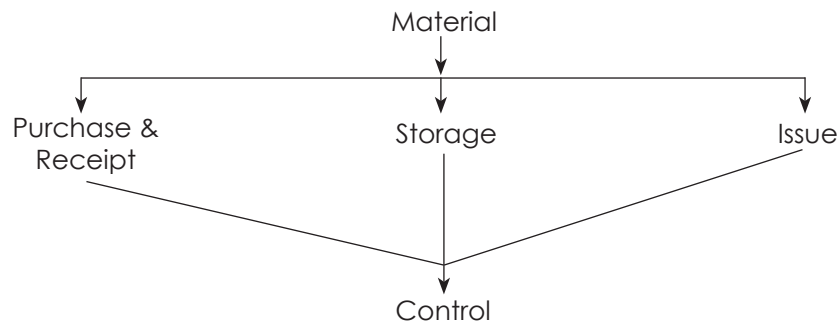

### Requisites of Material Control System

- (a) Coordination and cooperation between the various departments concerned viz purchase, receiving, inspection, storage, issues and Accounts and Cost departments
- (b) Use of standard forms and documents in all the stages of control
- (c) Classification, coordination, standardization and simplification of materials
- (d) Planning of requirement of material
- (e) Efficient purchase organization
- (f) Budgetary control of purchases
- (g) Planned storage of materials, physical control as well as efficient book control through satisfactory storage control procedures, forms and documents
- (h) Appropriate records to control issues and utilization of stores in production
- (i) Efficient system of Internal Audit and Internal Checks
- (j) System of reporting to management regarding material purchase, storage and utilization

### Importance of Proper Recording and Control of Material

Materials constitute a significant part for manufacturing of products in an organisation. Being an input and a significant element of cost, it requires proper attention of the management because the cost control begins from here. Therefore, it is necessary that the principles of 3Es (Economy, Efficiency and Effectiveness) i.e. economy in procurement, efficiency in handling of material and effectiveness in manufacturing the desired product as per the standard is ensured.

The importance of proper recording and control of materials are enumerated below:

1. Price of the final product
2. Quality of final product
3. Continuity of production
4. Stock holding and Stock out cost
5. Wastage and losses
6. Regular information about availability and utilisation of materials



### Elements of Material Control

Material control involves efficient functioning of the following activities:

- (a) Purchasing of materials
- (b) Receiving of materials
- (c) Inspection of materials
- (d) Storage of materials
- (e) Issuing materials
- (f) Maintenance of inventory records
- (g) Stock audit

### Purchase Flow

The main functions of a purchase department are as follows :-

- (a) What to purchase? – Right Material with good quality
- (b) When to purchase? – Right Time
- (c) Where to purchase? – Right Source
- (d) How much to purchase? – Right Quantity
- (e) At what price to purchase? – Right Price

To perform these functions effectively, the purchasing department follows the following procedure:-

- (a) Receiving purchase requisitions
- (b) Exploring the sources of supply and choosing the supplier
- (c) Preparation and execution of purchase orders
- (d) Receiving materials
- (e) Inspecting and testing materials
- (f) Checking and passing of bills for payment

### Purchase Organisation

Purchasing involves procurement of materials of requisite quantity and quality at economic price. It is of extreme importance particularly to a manufacturing concern because it has bearing on all vital factors of manufacture such as quantity, quality, cost, efficiency, economy, prompt delivery, volume of production and so on. Purchase department in a business concern can be organized into two types i.e Centralised Purchasing System and De-centralised Purchasing System. Purchasing process in most of the organisation is a centralised function because the advantages of a centralised purchasing out weight its disadvantages. Lets us see the merits and demerits of both the systems.

### Merits of a centralised & De-merits of decentralised purchase organization

- (a) When materials are purchased favourable terms (Trade discount, Economies of transport...etc) can be obtained because the quantity involved will be large. In case of decentralised system these benefits cannot be realised.
- (b) Specialised purchasing officer can be appointed with the specific purpose of highly efficient purchases functions of the concern. In case of decentralised purchase system, the business entity cannot afford a specialised purchasing officer in every location.



- (c) Effective control can be exercised over the stock of materials because duplication of purchase of the same materials may easily be avoided in centralised purchase system, where as in decentralised purchase system, duplication of purchase of same material cannot be avoided.
- (d) Under centralised purchase system effective control can be exercised on the purchases of all the materials as the purchase function is channelised through one track which would make the system of receiving, checking and inspection efficient. Where as in decentralised purchase system it is very difficult to exercise controls.
- (e) Under centralised system of purchase materials, components and capital equipments can be suitably standardised so that the maximum purchasing benefits be availed of, storage facilities can be improved and available production facilities can be greatly utilised to the maximum possible extent. Under decentralised purchase system standardization of materials, storage facilities.....etc is very difficult to achieve.
- (f) Under centralised system of purchase closer cooperation between the financial and purchasing departments can be achieved which may not be easy under decentralised purchase system.

#### **De-Merits of a centralised & Merits of decentralised purchase organization**

- (a) It may take unnecessarily long time to place a purchase order under centralised purchase system because to collect the relevant data from various departments/ branches/locations may take more time. These delays can be avoided under decentralised purchase system.
- (b) In case of centralised purchasing system, branches at different places cannot take advantage of localised purchasing, whereas under decentralised purchase system localization savings can be realised.
- (c) Due to the Chances of misunderstanding / miscommunication between the branch and the centralised purchasing office may result in wrong purchase of material also. Whereas under decentralised purchase system, the chances of miscommunication/ misunderstanding is very limited.
- (d) Centralised system will lead to high initial costs because a separate purchasing department for purchase of materials is to be setup. No such costs are required to be incurred in the decentralised system.
- (e) Replacement of a defective item may take long time resulting in strain on smooth production flow under centralised system of purchase. No such delay in decentralised system.

Now let us see the various material control documents in detail.

#### **Bill of Material**

Bill of Material is a complete schedule of parts and materials required for a particular order prepared by the Drawing Office and issued by it together with necessary blue prints of drawings. For standard products, printed copies of Bill of Material are kept with blank spaces for any special details of modification to be filled in for a particular job/order. The schedule details everything, even to bolts and nuts, sizes and weights. The document solves a number of useful purposes, such as:

- (a) It provides a quantitative estimate of budget of material required for a given job, process or operation which might be used for control purposes.
- (b) It substitutes material requisitions and expedite issue of materials.
- (c) The store-keeper can draw up a programme of material purchases and issue for a given period.
- (d) It provides the basis for charging material cost to the respective job/process.





The specimen form of Bill of Materials is shown below:

<b>Modern Ltd</b>										
<b>Bill of Materials</b>										
No.....						Order No.....				
Date.....						Job No.....				
Assembly drawing no.....										
Component parts			Materials			For use of purchase dept				
Symbol No.	Description	No. reqd.	Description	Code No.	Qty. Reqd.	Date	Reqn no.	Order No.	Date of delivery	Remarks
Purchase dept. Copy	Date of order Delivery:		Prepared by:			Purchase order given by:				
			Checked by:							

**Material Requisition Note**

Material Requisition is a document issued by a department in charge requesting the Storekeeper to issue certain materials to a job or standing order number. It is an important document as it authorises issue of materials from stores and thereby should be authenticated by appropriate authority. It forms the basis of crediting the Marginal Account in the stores ledger as the materials are taken out on the strength of such documents. The corresponding debit to work-in-progress account or Job Account for standing order number is also made on the basis of such documents. This document enables the Accounts Department to value the issue of the materials to find out the cost of materials issued. The storekeeper uses this department to check total item wise issues made by him during a certain period by adding up the details of issue from this document.

**Purchase Requisition**

Purchases Requisition is a request made to the Purchase Department to procure materials of given description and of the required quality and quantity within a specified period. It is a formal request and it authorizes the Purchase Department to issue a Purchase Order to secure materials intended for periodic requirements of a given material or materials to provide guidance to the Purchase Department to estimate the future requirements in order to secure maximum purchase benefits in the form of higher discount and better credit terms. The extent and range of materials requirements provide a basis for preparation of a purchase budget. The actual requirements of a given period can be summarised from the purchases requisition and compared with the purchase budget in order to determine the variances and the reasons thereof. This form is prepared by storekeeper for regular items and by the departmental head for special materials not stocked as regular items.

The Purchase Requisition is prepared in three copies. Original will be sent to Purchase department, Duplicate copy will be retained by the indenting (request initiating) department and the triplicate will be sent to approver for approving the purchase requisition.

Purchase Requisition provides the three basic things :-

- (a) What type of material is to be purchased?
- (b) When to be purchased?
- (c) How much is to be purchased?



The specimen form of Purchase Requisition is as shown below :

<b>Modern Ltd</b>					
<b>Purchase Requisition or Indent</b>					
Purchase Req Type: Special / Regular :  Purchase Req No : <span style="float: right;">Purchase Requisition Date :</span>  Department :					
S.No	Material Code	Description of the Goods	Quantity Required	Material Required by date	Remarks
Requested by			Approved by		
<b>For use in Purchase Dept.</b>					
Quotations from					
(1)	PO Placed : Yes /No				
(2)	PO No:				
(3)					

A number of factors should be considered before deciding from where the purchase should be made viz. inquiry and call for tenders or quotations, analysis of tenders called, selection of the appropriate source with appropriate fixation of price, quality, time of delivery, terms of payment, mode of delivery, etc.

**Purchase Order**

Purchase Order (PO) is a request made in writing to selected supplier to deliver goods of requisite quality, quantity, (as per the purchase requisition) at the prices, terms and conditions agreed upon. It is a commitment on the part of the purchaser to accept the delivery of goods contained in the Purchase Order if the terms included therein, are fulfilled. Purchase Order contains the following details :-

- (a) Purchase Order No; (b) PO Date; (c) Supplier Name and Address; (d) Material Code; (e) Material description; (f) Grade & Other particulars of the material; (g) Quantity to be supplied; (h) Price; (i) Place of delivery; (j) Taxes; (k) Terms of Payment (Credit period) .....etc

Usually a purchase order is made in five copies, one each for suppliers, Receiving/Stores Department, Originating Department, Accounts Department and filing. Thus we see that all the departments concerned with the materials are informed fully about all the details of every purchases and it becomes easier for everyone to follow up on any relevant matter.



<b>Modern Ltd</b>							
<b>Purchase Order</b>							
To Supplier XXXXXX				PO No:			
Address				PO date:			
				Quotation			
				Reference:			
				PR No:			
Please supply the following items in accordance with the instructions mentioned there in on the following terms and conditions.							
S.No	Material Code	Material Description	Quantity	Rate per Unit	Amount	Delivery Date	Remarks
Packing & Freight							
Taxes							
Total Amount							
Delivery: Goods to be delivered at Delivery date: Payment Terms:							
							Authorised signatory

**Receipt & Inspection of Materials**

*Goods Received cum Inspection Note*

The stores department will receive the material after the gate entry. It will compare the quantities received with the PO Quantity. It is a valuable document as it forms the basis of accounting entry in the stores ledger and stock records. It is the document basis for quality control department to carry inspection of the material in warded.

It also forms the basis of payments to be made to the supplier in respect of the materials supplied by him. Suppliers invoices are checked with goods received notes which such for actual receipt of the goods supplied by the supplier. One copy of such note is also sent to Inspection Department who after inspection of materials approves the note for Stores Department to receive the materials. Outstanding Goods Received Notes which are not linked with supplier's bills enable the Accounts Department to estimate at the year end the liability for goods purchased for which supplier's bills not received.



The specimen copy of the Goods Received cum Inspection Note as below:

<b>New India Ltd</b>																																																							
<b>Goods Received cum Inspection Note</b>																																																							
Received from:				GRN No:																																																			
Received at:				GR Date:																																																			
				PO Ref No:																																																			
				Gate Entry No:																																																			
<table border="1" style="width: 100%; border-collapse: collapse;"> <thead> <tr> <th style="width: 10%;">S.No</th> <th style="width: 10%;">Material code</th> <th style="width: 20%;">Material Description</th> <th style="width: 10%;">Quantity Received</th> <th style="width: 10%;">Quantity Accepted</th> <th style="width: 10%;">Qty Rejected</th> <th style="width: 10%;">Reason for Rejection</th> <th style="width: 10%;">Remarks</th> </tr> </thead> <tbody> <tr><td> </td><td> </td><td> </td><td> </td><td> </td><td> </td><td> </td><td> </td></tr> <tr><td> </td><td> </td><td> </td><td> </td><td> </td><td> </td><td> </td><td> </td></tr> <tr><td> </td><td> </td><td> </td><td> </td><td> </td><td> </td><td> </td><td> </td></tr> <tr><td> </td><td> </td><td> </td><td> </td><td> </td><td> </td><td> </td><td> </td></tr> <tr><td> </td><td> </td><td> </td><td> </td><td> </td><td> </td><td> </td><td> </td></tr> </tbody> </table>								S.No	Material code	Material Description	Quantity Received	Quantity Accepted	Qty Rejected	Reason for Rejection	Remarks																																								
S.No	Material code	Material Description	Quantity Received	Quantity Accepted	Qty Rejected	Reason for Rejection	Remarks																																																
Prepared by				Inspected by																																																			
Received by				Storekeeper																																																			

### Material Transfer Note

Material Transfer Note is a document used for transferring the material from one department to other department or one site to other site or one job to other job. The need for Material Transfer Note arises under the following conditions:

- (a) Great urgency for such materials as normal procedure for requisitioning the materials may result in delay in completion of the job.
- (b) Where two jobs are being executed side by side or very near to each other and stores department is situated at a great distance, adoption of normal procedure for requisitioning the materials may mean unnecessary expenditure in handling and transportation, especially in cases of heavy materials (e.g. iron rails).
- (c) Frequent shifting of materials (for returning to stores and for re-issue) may result in wastage or breakage.
- (d) If the goods are of perishable nature (e.g. Vegetable or Fruits) and refrigeration may not keep them fresh for a long time.

### Procedure to be followed to transfer the material

- (a) Transferring supervisor will prepare a Material Transfer Note giving all the details of the materials transferred and will send this note to the supervisor of the job to which materials being transferred.
- (b) Transferee supervisor will sign the note in token of receipt of the materials and send it back to the transferring supervisor.
- (c) This note will then be send to Cost Office where necessary entries will be passed and respective job accounts debited and credited.



### Material Return Note

At times materials have to be returned to the suppliers after these are received in the factory. If the return takes place before the preparation of Goods Received Note, such materials will not be included and shown in the stores ledger. However, if the material is returned after the entry into the Goods Received Note, a document called "Material Return Note" will be prepared simultaneously to exclude the quantity and value of the returned material from the stores ledger.

### Purchase Quantity

Important requirement for an efficient system of purchase control is to ensure that only the correct quantity of materials is purchased. The basic factors to be considered while fixing the ordering quantity are as follows :-

- (a) There should be no overstocking.
- (b) Materials should always be available in sufficient quantity to meet the requirements of production and to avoid plant shut down.
- (c) Purchases should be made in economic lots.

Other factors to be considered are quantity already ordered, availability of funds, business cycle... etc.

Purchase department in manufacturing concerns is usually faced with the problem of deciding the quantity of various items, which they should purchase basing on the above factors. If purchases of material are made in bulk then inventory cost will be high. On the other hand if the order size is small each time then the ordering cost will be very high. In order to minimise ordering and carrying costs it is necessary to determine the order quantity which minimises these two costs.

### Economic Order Quantity: (EOQ)

The total costs of a material usually consist of Buying Cost + Total Ordering Cost + Total Carrying Cost.

Economic Order Quantity is 'The size of the order for which both ordering and carrying cost are minimum'.

**Ordering Cost:** The costs which are associated with the ordering of material. It includes cost of staff posted for ordering of goods, expenses incurred on transportation, inspection expenses of incoming material....etc

**Carrying Cost:** The costs for holding the inventories. It includes the cost of capital invested in inventories. Cost of storage, Insurance.....etc

The assumptions underlying the Economic Ordering Quantity (EOQ): The calculation of economic order of material to be purchased is subject to the following assumptions:-

- (a) Ordering cost per order and carrying cost per unit per annum are known and they are fixed.
- (b) Anticipated usage of material in units is known.
- (c) Cost per unit of the material is constant and is known as well.
- (d) The quantity of material ordered is received immediately i.e lead time is Zero.

The famous mathematician 'WILSON' derived the formula used for determining the size of order for each purchases at minimum ordering and carrying costs, which is as below :-

$$\text{Economic Ordering Quantity} = \sqrt{\frac{2AO}{C}}$$

Where,

A = Annual demand /Consumption

O = Ordering Cost per order

C = Carrying Cost per unit per annum.

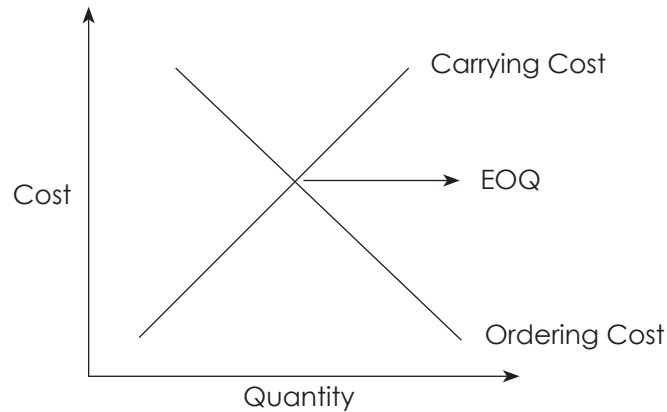
**Graphical representation of EOQ:****Illustration 1**

Calculate the Economic Order Quantity from the following information. Also state the number of orders to be placed in a year.

Consumption of materials per annum	:	10,000 kg
Order placing cost per order	:	₹ 50
Cost per kg. of raw materials	:	₹ 2
Storage costs	:	8% on average inventory

**Solution:**

$$EOQ = \sqrt{\frac{2 \times A \times O}{C}}$$

A = Units consumed during year = 10,000 Kg.

O = Order cost per order = ₹50

C = Inventory carrying cost per unit per annum  $2 \times 8\% = ₹ 0.16$

$$EOQ = \sqrt{\frac{2 \times 10,000 \text{ (units)} \times ₹ 50}{₹ 0.16}}$$

EOQ = 2,500 kg.

$$\begin{aligned} \text{No. of orders to be placed in a year} &= \frac{\text{Total consumption of materials per annum}}{\text{EOQ}} \\ &= \frac{10,000 \text{ kg}}{2,500 \text{ kg}} \\ &= 4 \text{ Orders per year} \end{aligned}$$



### Illustration 2

The average annual consumption of a material is 18,250 units at a price of ₹ 36.50 per unit. The storage cost is 20% on an average inventory and the cost of placing an order is ₹ 50. How much quantity is to be purchased at a time?

#### Solution:

$$\begin{aligned} \text{EOQ} &= \sqrt{\frac{2 \times 18,250 \text{ (units)} \times ₹ 50}{20\% \text{ of } ₹ 36.50}} \\ &= \sqrt{\frac{18,25,000}{7.3}} \\ &= 500 \text{ Units} \end{aligned}$$

### Material Storage & Control

Once the material is received, it is the responsibility of the stores-in-charge, to ensure that material movements in and out of stores are done only against the authorized documents. Stores-in-charge is responsible for proper utilization of storage space & exercise better control over the material in the stores to ensure that the material is well protected against all losses such as theft, pilferage, fire, misappropriation ...etc.

#### Duties of store keeper

The duties of store-keeper are as follows :-

- (a) To exercise general control over all activities in stores department
- (b) To ensure safe storage of the materials
- (c) To maintain proper records
- (d) To initiate purchase requisitions for the replacement of stock of all regular materials, whenever the stock level of any item in the store reaches the Minimum Level
- (e) To initiate the action for stoppage of further purchasing when the stock level approaches the Maximum Level
- (f) To issue materials only in required quantities against authorized requisition documents
- (g) To check and receive purchased materials forwarded by the receiving department and to arrange for storage in appropriate places

#### Different classes of stores

Broadly speaking, there are three classes of stores

- (a) Central Stores
- (b) Decentralised stores
- (c) Sub-Store (Imprest Store)

#### Centralised stores

The usual practice in most of the concerns is to have a central store. Separate store to meet the requirements of each production department are not popular because of the heavy expenditure involved. In case of centralised stores materials are received by and issued from one stores department. All materials are kept at one central store. The advantages and disadvantages of this type of store are set out as follows:



### **Advantages of centralised stores**

- (a) Better control can be exercised over stores because all stores are housed in one department. The risk of obsolescence of stores can be minimised.
- (b) The economy of staff-experts, or clerical, floor space, records and stationery are available.
- (c) Better supervision is certainly possible.
- (d) Obsolescence of the stores items can be kept under strict vigil and control.
- (e) Centralised material handling system can be put into operation thus further economising on space, personnel and equipments.
- (f) Investment in stocks can be minimized.

### **Disadvantages of centralised stores**

- (a) The transportation costs of the materials may increase because the movements of the stores may be for a greater distance since the storing is centralised.
- (b) If the user departments are far away from the stores there may be delay in receipt of the stores by those departments.
- (c) Breakdown of inter-departmental transport system may hold up the entire process, and similarly labour problem in the centralised stores may bring the entire concern to standstill.
- (d) There is greater chance of losses through fire, burglary or some other unhappy incidents.
- (e) It may not be safe to have some hazardous elements bunched together in the centralised stores.

### **Decentralised stores**

Under this type of stores, independent stores are situated in various departments. Handling of stores is undertaken by the store keeper in each department. The departments requiring stores can draw them from their respective stores situated in their departments. The disadvantages of centralised stores can be eliminated, if there are decentralised stores. But these types of stores are uncommon because of heavy expenditure involved.

### **Central stores with sub-stores**

In large organizations, factories / workshops may be located at different places which are far from the central stores. So in order to keep the transportation costs and handling charges to the minimum level, sub-stores should be situated near to the factory. For each item of materials a quantity is determined and this should be kept in the stock at the beginning of any period. At the end of a period, the store keepers of each sub-store will requisition from the central stores the quantity of the materials consumed to bring the stock up to the predetermined quantity. In short this type of stores operates in a similar way to a petty cash system, so this system of stores is also known as the imprest system of stores control.

### **Advantages**

- (a) It ensures the prompt issue of stores.
- (b) It confines the advantages of centralised stores with sub-stores and at the same time it does not sacrifice the centralised control.
- (c) It reduces handling cost of materials.
- (d) It avoids the maintenance of elaborate inventory records.





## Control of the Stores

### Classification and Codification of Material

In case of large organizations the number and types of materials used is considerable and unless each item is distinguished and stored separately it would be impossible to find them out when they are required for production or any other operation. It may happen that either one type of material is in excess or another type may be altogether non-existent. It is therefore, essential that a proper system of classification and codification.

Classified into different categories according to their nature or type, viz., mild steel, tool steel, brass, bronze, copper, glass, timber, etc., and then again within such broad classification into rounds; bars, strips; angles, etc. There are two steps in the classification and codification of materials - determination of the number of items, their nature, other characteristics and classification of the items of comparable nature or type into suitable groups or classes.

Various classes of coding are in practice and the common types are stated below:

- (a) **Alphabetical Scheme:** Alphabets are only used for codification. Like Mild Steel Sheets are coded as MSS.
- (b) **Numeric Scheme :** In this scheme numerals are used instead of alphabets, For example If steel is given main code of 300 mild steel may be coded as 310 and mild steel sheet may be coded as 311, mild steel bar may be coded as 312.
- (c) **Decimal Scheme:** It is similar to the numeric scheme in which the groups are represented by number and digits after the decimal indicate sub-groups of items. For example, where the steel is coded as 3.00 mild steel may be coded as 3.10 and mild steel sheet can be coded as 3.11 and mild sheet bar as 3.12 and so on.
- (d) **Block Scheme:** In this case block of number are allotted for classification of specific groups such as for material classification the block of number 1 to 999 may be reserved, for raw materials; 1000 to 1999 for stores and spares; 2000 to 2999 for finished goods.
- (e) **Combination Scheme :** Here the code structure takes in account both alphabetic and numeric schemes and strikes a balance between the two. Mild steel by coded as MS and the sheets, bars, strips, rounds of mild steel may be coded as MS01, MS02, MS04 and so on. This code is most commonly used because this system has got the advantage of both the alphabetic and numeric systems and is quite flexible in nature.

### Advantages of Classification & Codification of materials

- (a) The procedure assists in the easy identification and location of the materials because of their classification.
- (b) It minimises the recording of the nature/ type of the materials with detailed description on every document relating to the transaction of materials.
- (c) Codification is a must in the case of mechanisation of the stores accounting.
- (d) The method is simple to operate and definitely saves time and money in respect of both physical location/ identification of materials as well as recording of the materials.

After the material classification and codification is done for all the materials, for each material code we have to fix the Minimum Level, Maximum Level, Re-order Level and Re-order Quantity. It is the storekeeper's responsibility to ensure inventory of any material is maintained between the Minimum Level and Maximum Level.

### Maximum Level

The Maximum Level indicates the maximum quantity of an item of material that can be held in stock at any time. The stock in hand is regulated in such a manner that normally it does not exceed this level.



While fixing the level, the following factors are to be taken into consideration:

- (a) Maximum requirement of the store for production purpose, at any point of time
- (b) Rate of consumption and lead time
- (c) Nature and properties of the Store: For instance, the maximum level is necessarily kept low for materials that are liable to quick deterioration or obsolescence during storage.
- (d) Storage facilities that can be conveniently spared for the item without determinant to the requirements of other items of stores.
- (e) Cost of storage and insurance
- (f) Economy in prices: For seasonal supplies purchased in bulk during the season, the maximum level is generally high.
- (g) Financial considerations: Availability of funds and the price of the stores are to be kept in view. For costly items, the maximum level should be as low as possible. Another point to be considered is the future market trend. If prices are likely to rise, the concern may like to stock-piling for keeping large stock in reserve for long-term future uses and in such a case, the level is pushed up.
- (h) Rules framed by the government for import or procurement. If due to these and other causes materials are difficult to obtain and supplies are irregular the maximum level should be high.
- (i) The maximum level is also dependent on the economic ordering quantity.

**Maximum Level = Re-Order Level + Re-Order Qty – (Minimum Rate of Consumption × Minimum Re-Order Period)**

#### **Minimum Level**

The Minimum Level indicates the lowest quantitative balance of an item of material which must be maintained at all times so that there is no stoppage of production due to the material being not available. In fixing the minimum level, the following factors are to be considered :-

- (a) Nature of the item: For special material purchased against customer's specific orders, no minimum level is necessary. This applies to other levels also.
- (b) The minimum time (normal re-order period) required replenishing supply: This is known as the Lead Time and are defined as the anticipated time lag between the dates of issuing orders and the receipt of materials. Longer the lead time, lower is minimum level, the re-order point remaining constant.
- (c) Rate of consumption (normal, minimum or maximum) of the material.

**Minimum Level = Re-Order level – (Normal Rate of Consumption × Normal Re-Order Period)**

#### **Re-Order Level**

When the stock in hand reach the ordering or re-ordering level, store keeper has to initiate the action for replenish the material. This level is fixed somewhere between the maximum and minimum levels in such a manner that the difference of quantity of the material between the Re-ordering Level and Minimum Level will be sufficient to meet the requirements of production up to the time the fresh supply of material is received.

The basic factors which are taken into consideration in fixing a Re-ordering Level for a store item include minimum quantity of item to be kept, rate of consumption and lead time which are applied for computing of this level.

**Re-Ordering level = Minimum Level + Consumption during lead time**  
**= Minimum Level + (Normal Rate of Consumption × Normal Re-order Period)**

**Another formula for computing the Re-Order level is as below:**

**Re-Order level = Maximum Rate of Consumption × Maximum Re-Order period (lead time)**



### Danger Level

It is the level at which normal issue of raw materials are stopped and only emergency issues are only made. This is a level fixed usually below the Minimum Level. When the stock reaches this level very urgent action for purchases is indicated. This presupposed that the minimum level contains a cushion to cover such contingencies. The normal lead time cannot be afforded at this stage. It is necessary to resort to unorthodox hasty purchase procedure resulting in higher purchase cost.

The practice in some firms is to fix danger level below the Re-Ordering Level but above the Minimum Level. In such case, if action for purchase of an item was taken when the stock reached the Re-Ordering Level, the Danger Level is of no significance except that a check with the purchases department may be made as soon as the Danger Level is reached to ensure that everything is all right and that delivery will be made on the scheduled date.

$$\text{Danger Level} = \text{Normal Rate of Consumption} \times \text{Maximum Reorder Period for emergency purchases}$$

### Illustration 3

The components A and B are used as follows:

Normal usage	.... 300 units per week each
Maximum usage	.... 450 units per week each
Minimum usage	.... 150 units per week each
Reorder Quantity	.... A 2,400 units; B 3,600 units.
Reorder period	.... A 4 to 6 weeks, B 2 to 4 weeks.

Calculate for each component:

- (a) Re-order Level (b) Minimum Level (c) Maximum Level (d) Average Stock Level.

### Solution:

	Particulars	A	B
a)	Reorder Level [Max. Consumption × Max. Re-order Period]	2700 units (450 × 6)	1800 units (450 × 4)
b)	Minimum Level [ROL – (Normal Consumption × Normal Re-order period)]	1200 units [2700 – (300×5)]	900 units [1800 – (300×3)]
c)	Maximum Level [ROL + ROQ – (Min. Consumption × Min. Re-order Period)]	4500 units [2700 + 2400 – (150×4)]	5100 units [1800 + 3600 – (150 × 2)]
d)	Average Stock Level [Min. Level + Max. Level] / 2 OR [Min. Level + ½ Re-order Quantity]	2850 units [4500 + 1200]/2 (or) 2400 units 1200 + ½ (2400)	3000 units [5100 + 900]/2 (or) 2700 units 900 + ½ (3600)



### Stores Records

The bin cards and the stores ledger are the two important stores records that are generally kept for making a record of various items.

#### Bin Card

Bin Card is a quantitative record of receipts, issues and closing balance of items of stores. Separate bin cards are maintained for each item and are placed in shelves or bins. This card is debited with the quantity of stores received, credited with the quantity of stores issued and the balance of quantity of store is taken after every receipt or issue. The balance quantity of the item may be easily known at any time. To have an up to date balance of stores, the principle of '*before touching the item, bin card should be touched*'. For each item of stores, Material Code, Minimum Quantity, Maximum Quantity, Ordering Quantity, Balance Quantities are stated on the bin card. Bin card is also known as 'Bintag' or 'Stock card'.

BIN CARD OF APHME LTD							
Material Code:				Maximum Level:			
Mat. Description:				Minimum Level:			
Location:				Re-ordering level:			
Unit of Measurement:							
Date	Doc No.	Received from / Issued to	Receipts	Issue	Balance	Verification with Stores ledger Date & Verified By	

#### Stores Ledger

Stores Ledger is maintained by the costing department to make record of all receipts, issues of materials with quantities, values (Sometimes unit rates also). Ledger resembles with bin cards except that receipts, issues and balances are shown along with their money value. The ledger contains an account for every item of stores in which receipts, issues and balances are recorded both in quantity and value.



**Stores Ledger of Krishna Engineering Ltd.**

Material code:  
Bin No:  
Material Description:  
Location:

Minimum Qty:  
Maximum Qty:  
Ordering Qty:

Date	Receipts				Issues				Balance		
	GR No	Qty	Rate	Amount	SR No	Qty	Rate	Amount	Qty	Rate	Amount

**Difference between Bin Card and Stores Ledger**

Bin Card	Stores Ledger
(a) It is maintained by the store keeper.	(a) It is maintained in the Costing department.
(b) It contains only quantitative details of materials received, issued and returned to stores.	(b) It contains information both in quantity and value.
(c) Entries are made when transactions take place.	(c) It is always posted after the transaction.
(d) Each transaction is individually posted.	(d) Transactions may be summarized and then posted.
(e) Inter-department transfers do not appear in Bin-card.	(e) Material transfers from one job to another job are recorded for costing purpose.

**Reconciliation of Stores ledger and Bin Card**

Normally there should not be any difference between the quantities shown in the Bin Card and the Stores Ledger. However, in practice differences arise mainly due to the following reasons :-

- (a) Arithmetical error in working out the balances
- (b) Non-posting of a document either in a bin card or in the stores ledger may be due to non receipt of a document.
- (c) Posting in the wrong bin card or in the wrong sheet (code) of the stores ledger



- (d) Posting of receipts under issue and vice-versa.
- (e) Materials issued or received on loan or for approval are sometimes entered in bin card, but not in stores ledger.

Any difference between the stores ledger and bin card defeats the purpose for which the two separate sets are maintained and renders physical stocking ineffective as the correct book balance for the purpose of comparison with physical balance is not available. So to control or reduce the mismatch between the stores ledger and bin card and maintain the correct balance in the books of accounts various methods are followed.

### **Perpetual Inventory System**

Perpetual Inventory System may be defined as 'a system of records maintained by the controlling department, which reflects the physical movements of stocks and their current balance'. Thus it is a system of ascertaining balance after every receipt and issue of materials through stock records to facilitate regular checking and to avoid closing down the firm for stock taking. To ensure the accuracy of the perpetual inventory records (bin card and Stores ledger), physical verification of stores is made by a programme of continuous stock taking.

The operation of the perpetual inventory system may be as follows :-

- (a) The stock records are maintained and up to date posting of transactions are made there in so that current balance may be known at any time.
- (b) Different sections of the stores are taken up by rotation for physical checking. Every day some items are checked so that every item may be checked for a number of times during the year.
- (c) Stores received but awaiting quality inspection are not mixed up with the regular stores at the time of physical verification, because entries relating to such stores have not yet been made in the stock records.
- (d) The physical stock available in the store, after counting, weighing, measuring or listing as the case may be, is properly recorded in the bin cards / Inventory tags and stock verification sheets.

Perpetual inventory system should not be confused with continuous stock taking; Continuous stock taking is an essential feature of perpetual inventory system. *Perpetual inventory means the system of stock records and continuous stock taking, where as continuous stock taking means only the physical verification of the stock records with actual stocks.*

In continuous stock taking, physical verification is spread throughout the year. Everyday 10 to 15 items are taken at random by rotation and checked so that the surprise element in stock verification may be maintained and each item may be checked for a number of times each year. On the other hand the surprise element is missing in case of periodical checking, because checking is usually done at the end of year.

### **Advantages of perpetual inventory system**

- (a) The system obviates the need for the physical checking of all items of stock and stores at the end of the year.
- (b) It avoids the dislocation of the routine activities of the organisation including production and despatch.
- (c) A reliable and detailed check on the stores is maintained.
- (d) Errors, irregularities and loss of stock through other methods are quickly detected and through necessary action recurrence of such things in future is minimised.



- (e) As the work is carried out systematically and without undue haste the figures are readily available.
- (f) Actual stock can be compared with the authorised maximum and minimum levels, thus keeping the stocks within the prescribed limits. The disadvantages of excess stocks are avoided and capitalised up in stores materials cannot exceed the budget.
- (g) The recorder level of various items of stores are readily available thus facilitating the work of procurement of stores.
- (h) For monthly or quarterly financial statements like Profit and Loss Account and Balance Sheet the stock figures are readily available and it is not necessary to have physical verification of the balances.

### **Periodical Stock Verification**

This system envisages physical stock verification at a fixed date/period during the year. Generally under this system the activity takes place at the end of the accounting period or a date close to such date. Usually the system is opened in the following manner :-

- (a) A period of 5/7 days, depending on the magnitude of the work is chosen during which all the items under stock are verified physically and such period is known as 'cut-off' period. During this period there are no movements of stock items and neither 'receipts' nor are 'issues permitted.
- (b) The items are physically counted/measured depending on their nature and are noted down in records which are signed by the auditors if they are present in stock verification.
- (c) The bin cards balances are also checked and initiated. Generally the physical balances and bin card balances of various items should be same unless shortage/excesses are there or the recording/ balancing in the cards are incorrect.
- (d) After the physical verification is completed work sheets are countersigned by the godown supervisors and the stock verified.
- (e) Thereafter reconciliation statement is prepared item wise where the physical balances and bin card balances are different.
- (f) Then the balance as per bin cards and as per stores ledger is also compared and necessary adjustments are made to show the correct position of stock at the year end.
- (g) Finally the shortages/excess statement is prepared by the concerned departments and are placed before the higher management for their approval for adjustments.

### **ABC Analysis**

The "ABC Analysis" is an analytical method of stock control which aims at concentrating efforts on those items where attention is needed most. It is based on the concept that a small number of the items in inventory may typically represent the bulk money value of the total materials used in production process, while a relatively large number of items may present a small portion of the money value of stores used resulting in a small number of items be subjected to greater degree of continuous control.

Under this system, the materials stocked may be classified into a number of categories according to their importance, i.e., their value and frequency of replenishment during a period. The first category (we may call it group 'A' items) may consist of only a small percentage of total items handled but combined value may be a large portion of the total stock value. The second category, naming it as group 'B' items, may be relatively less important. In the third category, consisting of group 'C' items, all the remaining items of stock may be included which are quite large in number but their value is not high.



This concept may be clear by the following example:

Category	No. of Items	% of the Total No. of Items	Value Amount (₹)	% of the Total Value Item	Average Value Amount (₹)
A	75	6	70,000	70	933
B	375	30	20,000	20	53
C	800	64	10,000	10	12
	1250	100	1,00,000	100	998

Category 'A' items represent 70% of the total investment but as little as only 6% of the number of items. Maximum control must be exercised on these items. Category 'B' is of secondary importance and normal control procedures may be followed. Category 'C' comprising of 64% in quantity but only 10% in value, needs a simpler, less elaborate and economic system of control.

**The advantages of ABC analysis are:**

- Close and stricter control of those items which represent a major portion of total stock value is maintained.
- Investment in inventory can be regulated and funds can be utilised in the best possible manner. 'A' class items are ordered as and when need arises, so that the working capital can be utilised in a best possible way.
- With greater control over the inventories, savings in material cost will be realised.
- It helps in maintaining enough safety stock for 'C' category of items.
- Scientific and selective control helps in the maintenance of high stock turnover ratio.

**VED Analysis**

VED stands for Vital, Essential and Desirable- analysis is used primarily for control of spare parts. The spare parts can be classified in to three categories i.e Vital, Essential and Desirable- keeping in view the criticality to production.

**Vital:** The spares, stock-out of which even for a short time will stop the production for quite some time, and where in the stock-out cost is very high are known as Vital spares. For a car Assembly Company, *Engine* is a vital part, without the engine the assembly activity will not be started.

**Essential:** The spares or material absence of which cannot be tolerated for more than few hours or a day and the cost of lost production is high and which is essential for production to continue are known as Essential items. For a car assembly company 'Tyres' is an essential item, without fixing the tyres the assembly of car will not be completed.

**Desirable:** The Desirable spares are those parts which are needed, but their absence for even a week or more also will not lead to stoppage of production. For example, CD player, for a car assembly company.

Some spares though small in value, may be vital for production, requires constant attention. Such spares may not pay attention if the organization adopts ABC analysis.

**FSN Analysis**

FSN analysis is the process of classifying the materials based on their movement from inventory for a specified period. All the items are classified in to F-Fast moving, S- Slow moving and N-Non-moving Items based on consumption and average stay in the inventory. Higher the stay of item in the inventory, the slower would be the movement of the material. This analysis helps the store keeper / purchase department to keep the fast moving items always available & take necessary steps to dispose off the non-moving inventory.





### Just-in-Time

Just in time (JIT) is a production strategy that strives to improve a business return on investment by reducing in-process inventory and associated carrying costs. Inventory is seen as incurring costs, or waste, instead of adding and storing value, contrary to traditional accounting. In short, the Just-in-Time inventory system focuses on "the right material, at the right time, at the right place, and in the exact amount" without the safety net of inventory.

The advantages of Just-in-Time system are as follows :-

- Increased emphasis on supplier relationships. A company without inventory does not want a supply system problem that creates a part shortage. This makes supplier relationships extremely important.
- Supplies come in at regular intervals throughout the production day. Supply is synchronized with production demand and the optimal amount of inventory is on hand at any time. When parts move directly from the truck to the point of assembly, the need for storage facilities is reduced.
- Reduces the working capital requirements, as very little inventory is maintained.
- Minimizes storage space.
- Reduces the chance of inventory obsolescence or damage.

### Inventory Turnover Ratio

Inventory Turnover signifies a ratio of the value of materials consumed during a given period to the average level of inventory held during that period. The ratio is worked out on the basis of the following formula:

$$\text{Inventory Turnover Ratio} = \frac{\text{Value of material consumed during the period}}{\text{Value of average stock held during the period}}$$

The purpose of the above ratio is to ascertain the speed of movement of a particular item. A high ratio indicates that the item is moving fast with a minimum investment involved at any point of time. On the other hand a low ratio indicates the slow moving item. Thus Inventory Turnover Ratio may indicate slow moving dormant and obsolete stock highlighting the need for appropriate managerial actions.

### Illustration 4

Compute the Inventory turnover ratio from the following:

Opening Stock - ₹10,000

Closing Stock - ₹16,000

Material Consumed - ₹78,000

### Solution:

$$\text{Inventory Turnover Ratio} = \frac{\text{Value of material consumed during the period}}{\text{Value of average stock held during the period}}$$

$$\begin{aligned} \text{Average Stock} &= \frac{\text{Opening Stock} + \text{Closing Stock}}{2} \\ &= \frac{10,000 + 16,000}{2} = 13,000 \end{aligned}$$

$$\begin{aligned} \therefore \text{Inventory Turnover Ratio} &= \frac{78,000}{13,000} \\ &= 6. \text{ (times)} \end{aligned}$$



### Valuation of Material Receipts

Principles of valuation of receipt of materials as per CAS-6 (limited Revision 2017) are as follows:-

- (a) The material receipt should be valued at purchase price including duties and taxes, freight inwards, insurance and other expenditure directly attributable to procurement (net of trade discounts, rebates, taxes and duties refundable) that can be quantified with reasonable accuracy at the time of acquisition.
- (b) Finance costs incurred in connection with the acquisition of materials shall not form part of the material cost.
- (c) Self manufactured item shall be valued including the direct material, direct labour, direct expenses, factory overheads, share of administrative overheads relating to the production but excluding share of other administrative overheads, finance cost and marketing overheads. In case of captive consumption, valuation shall be in accordance with Cost Accounting Standard-4.
- (d) Spares which are specific to an item of equipment shall not be taken into inventory, but shall be capitalised with cost of specific equipment. Cost of Capital spares and / or insurance spares, whether procured with the equipment or subsequently, shall be amortized over a period, not exceeding the useful life of the equipment.
- (e) Normal loss or spoilage of material prior to reaching the factory or at places where the services are provided shall be absorbed in the cost of balance materials net of amounts recoverable from suppliers, insurers, carriers or recoveries from disposal.
- (f) Losses due to shrinkage or evaporation and gain due to elongation or absorption or moisture ...etc before the material is received is absorbed in material cost to the extent they are normal, with corresponding adjustment in quantity.
- (g) The foreign exchange component of imported material cost is converted at the rate on the date of transaction (material / service recording in books of accounts). Any subsequent change in the exchange rate till payment or otherwise shall not form part of the material cost.
- (h) Any demurrage or detention charges, or penalty levied by transport or other authorities shall not form part of the cost of materials.
- (i) Subsidy/grant/incentive and any such payment received / receivable with respect to any material shall be reduced from cost for ascertainment of the cost of the cost object to which such amounts are related.

### Valuation of Material Issues

Principles of valuation of issue of materials as per CAS-6 (Limited Revision, 2017) are as follows :-

- (a) Issues shall be valued using appropriate assumptions on cost flow such as FIFO, LIFO, and Weighted average rate. The method of valuation shall be followed on a consistent basis.
- (b) Where materials are accounted at standard cost, the price variances related to materials shall be treated as part of material cost.
- (c) Any abnormal cost shall be excluded from the material cost.
- (d) Wherever the material cost includes the transportation costs, determination of transportation cost shall be based on CAS-5, i.e Equalised Transportation Costs.
- (e) Material cost may include imputed costs not considered in Financial Accounts.
- (f) Self manufactured components and sub-assemblies item shall be valued including the direct material, direct labour, direct expenses, factory overheads, share of administrative overheads relating to the production but excluding share of other administrative overheads, finance cost and marketing overheads. In case of captive consumption, the valuation shall be in accordance with Cost Accounting Standard-4.



- (g) The material cost of normal scrap / defectives which are rejects shall be included in the material cost of goods manufactured. The material cost of actual scrap / defectives, not exceeding the normal shall be adjusted in the material cost of good production. Material cost of abnormal scrap/ defectives should not be included in material cost but treated as loss after giving credit to the realisable value of such scrap / defectives.

Materials issued from stores should be priced at the price at which they are carried in inventory. Material may be purchased from different suppliers at different prices in different situations, where as consumption may happen the entire inventory at a time or at different lots....etc. So issue of materials should be valued after considering the following factors:-

- (a) Nature of business and production process.
- (b) Management policy relating to the closing stock valuation.
- (c) Frequency of purchases and price fluctuations.

Several **methods of pricing of material issues** have been evolved; these may be classified into the following:-

#### **Cost Price Method**

- (a) First in First out
- (b) Last-in-first out
- (c) Base Stock Method

#### **Specific price method**

- (a) Average Price Method
- (b) Simple Average Price Method
- (c) Weighted Average Price Method
- (d) Moving Simple Average Method
- (e) Moving Weighted Average Method

#### **Market Price Methods**

- (a) Replacement Method
- (b) Realisable Price Method

#### **Notional Price Methods:**

- (a) Standard Price Method
- (b) Inflated Price Method

We may now briefly discuss all the above methods

#### **(1) First in – First Out Method**

It is a method of pricing the issue of materials in the order in which they are purchased. In other words the materials are issued in the order in which they arrive in the store. This method is considered suitable in times of falling price because the material cost charged to production will be high while the replacement cost of materials will be low. In case of rising prices this method is not suitable.

#### **Advantages of FIFO**

- (a) It is simple and easy to operate.
- (b) In case of falling prices, this method gives better results.
- (c) Closing stocks represents the market prices.



### **Disadvantages**

- (a) If the prices fluctuate frequently, this method may lead to clerical errors.
- (b) In case of rising prices this method is not advisable.
- (c) The material costs charged to same job are likely to show different rates.

### **(2) Last-in-First Out Method**

Under this method the prices of last received batch (lot) are used for pricing the issues, until it is exhausted and so on. During the inflationary period or period of rising prices, the use of LIFO would help to ensure the cost of production determined approximately on the above basis is approximately the current one. Under LIFO stocks would be valued at old prices, but not represent the current prices.

### **Advantages**

- (a) The cost of materials issued will be either nearer to and/or will reflect the current market price.
- (b) In case of falling prices profit tends to rise due to lower material cost

### **Disadvantages**

- (a) The computations become complicated if too many receipts are there.
- (b) Companies having JIT system will face this problem more.

### **(3) Base Stock Method**

A minimum quantity of stock under this method is always held at a fixed price as reserve in the stock, to meet a state of emergency, if arises. This minimum stock is known as Base Stock and is valued at a price at which the first lot of materials is received and remains unaffected by subsequent price fluctuations. The quantity in excess of the base stock may be valued either on the LIFO basis or FIFO basis. This method is not an independent method as it uses FIFO or LIFO. Its advantages and disadvantages therefore will depend upon the use of the other method.

### **(4) Specific Price Method**

This method is useful, especially when the materials are purchased for a specific job or work order, and as such these materials are issued subsequently to that specific job or work order at the price at which they were purchased. The cost of materials issued for production purposes to specific jobs represent actual and correct costs. This method is specific for non-standard products. This method is difficult to operate, especially when purchases and issues are numerous.

### **(5) Simple Average Price Method**

Under this method materials issued are valued at average price, which is computed by dividing the total of all units rate by the number of units.

Material Issue Price = Total of unit prices of each purchase / Total No of Units

This method is useful, when the materials are received in uniform lots of similar quantity and prices do not fluctuate considerably.

### **(6) Weighted Average Price Method**

This method removes the limitation of Simple Average Method in that it also takes into account the quantities which are used as weights in order to find the issue price. This method uses total cost of material available for issue divided by the quantity available for issue.

Issue Price = Total Cost of Materials in stock / Total Quantity of Materials in stock



### (7) Moving Simple Average Price Method

Under this method the rate for material issue is determined by dividing the total of the periodic simple average prices of a given number of periods by the number of periods. For determining the moving simple average price, it is necessary to fix up first period to be taken for determining the average. Suppose a three monthly period is decided upon and moving average rate for the month of April is to be computed. Under such situation, we have to make a simple list of the simple average price from January to March, add them up, and divide the total by three. To compute the moving average for May, we have to omit simple average rate pertains to January and add the rate relating to the April and divide the total by three.

### (8) Moving Weighted Average Price Method

Under this method, the issue, rate is computed by dividing the total of the periodic weighted average price of a given number of periods by the number of periods.

### (9) Replacement Method

Replacement price is defined as the price at which it is possible to purchase an item, identical to that which is being replaced or revalued. Under this method, materials issued are valued at replacement cost of the items. Advantage of this method is issue cost reflects the current market price. But the difficult involved under this method is determination of market price of material before each issue.

### (10) Realisable Price method

Realisable price means a price at which the material to be issued can be sold in the market. This price may be more or less than the cost price, at which it was originally purchased.

### (11) Standard Price Method

Under this method, materials are priced at some predetermined rate of standard price irrespective of the actual purchase cost of the materials. Standard cost is usually fixed after taking into consideration the current price, anticipated market trends. This method facilitates the control of material cost and task of judging the efficiency of purchase department. But it is very difficult to fix the standard price when the prices fluctuates frequently.

### (12) Inflated Price Method

In case of materials that suffers loss in weight due to natural or climatic factors ex: evaporation...etc the issue price of the materials is inflated to cover up the losses.

### Illustration 5

Prepare a statement showing the pricing of issues, on the basis of

- (a) Simple Average and
- (b) Weighted Average methods from the following information pertaining to Material-D

2016 March	1	Purchased 100 units @ ₹10 each
	2	Purchased 200 units @ ₹ 10.2 each.
	5	Issued 250 units to Job X vide M.R.No.12
	7	Purchased 200 units @ ₹10.50 each
	10	Purchased 300 units @ ₹10.80 each
	13	Issued 200 units to Job Y vide M.R.No.15
	18	Issued 200 units to Job Z vide M.R.No.17
	20	Purchased 100 units @ ₹11 each
	25	Issued 150 units to Job K vide M.R.No.25

**Solution:****(a) Simple Average Method:****Stores Ledger Account**

Date	Receipts			Issue			Balance	
	Qty.	Price Amount (₹)	Value Amount (₹)	Qty.	Price Amount (₹)	Value Amount (₹)	Qty.	Value Amount (₹)
2016								
March 1	100	10	1000	--	--	--	100	1000
March 2	200	10.2	2040	--	--	--	300	3040
March 5	--	--	--	250	10.10 <sup>(1)</sup>	2525	50	515
March 7	200	10.5	2100	--	--	--	250	2615
March 10	300	10.8	3240	--	--	--	550	5855
March 13	--	--	--	200	10.50 <sup>(2)</sup>	2100	350	3755
March 18	--	--	--	200	10.65 <sup>(3)</sup>	2130	150	1625
March 20	100	11	1100	--	--	--	250	2725
March 25	--	--	--	150	10.90 <sup>(4)</sup>	1635	100	1090

**Working Notes:**

- Calculation of Price for Issue on March 5th  
 $= (10 + 10.2) / 2 = ₹10.10$
- Calculation of Price for Issue on March 13th  
 $= (10.2 + 10.5 + 10.8) / 3 = ₹10.5$
- Calculation of Price for Issue on March 18th  
 $= (10.5 + 10.8) / 2 = ₹10.65$
- Calculation of Price for Issue on March 25th  
 $= (10.8 + 11) / 2 = ₹10.90$

**(b) Weighted Average Method:****Stores Ledger Account**

Date	Receipts			Issue			Balance	
	Qty.	Price Amount (₹)	Value Amount (₹)	Qty.	Price Amount (₹)	Value Amount (₹)	Qty.	Value Amount (₹)
2016								
March 1	100	10	1000	--	--	--	100	1000
March 2	200	10.2	2040	--	--	--	300	3040
March 5	--	--	--	250	10.13 <sup>(1)</sup>	2533	50	507
March 7	200	10.5	2100	--	--	--	250	2607
March 10	300	10.8	3240	--	--	--	550	5847
March 13	--	--	--	200	10.63 <sup>(2)</sup>	2126	350	3721
March 18	--	--	--	200	10.63 <sup>(3)</sup>	2126	150	1595
March 20	100	11	1100	--	--	--	250	2695
March 25	--	--	--	150	10.78 <sup>(4)</sup>	1617	100	1078

**Working Notes:**

1. Calculation of price for Issue on March 5<sup>th</sup>  
=  $3040/300 = ₹10.13$
2. Calculation of price for Issue on March 13<sup>th</sup>  
=  $5847/550 = ₹10.63$
3. Calculation of price for Issue on March 18<sup>th</sup>  
=  $3721/350 = ₹10.63$
4. Calculation of price for Issue on March 25<sup>th</sup>  
=  $2695/250 = ₹10.78$

**Illustration 6**

The stock of material held on 1-4-2015 was 400 units @ 50 per unit. The following receipts and issues were recorded. You are required to prepare the Stores Ledger Account, showing how the values of issues would be calculated under Base Stock Method, both through FIFO AND LIFO base being 100 units.

- |           |                                     |
|-----------|-------------------------------------|
| 2-4-2015  | Purchased 100 units @ ₹55 per unit  |
| 6-4-2015  | Issued 400 units                    |
| 10-4-2015 | Purchased 600 units @ ₹55 per unit  |
| 13-4-2015 | Issued 400 units                    |
| 20-4-2015 | Purchased 500 units @ ₹65 per unit. |
| 25-4-2015 | Issued 600 units                    |
| 10-5-2015 | Purchased 800 units @ ₹70 per unit  |
| 12-5-2015 | Issued 500 units                    |
| 13-5-2015 | Issued 200 units                    |
| 15-5-2015 | Purchased 500 units @ ₹75 per unit  |
| 12-6-2015 | Issued 400 units                    |
| 15-6-2015 | Purchased 300 units @ ₹ 80 per unit |



**Solution:**

**Stores Ledger Account [under Base Stock through FIFO Method]**

Date	Receipts			Issue			Balance		
	Qty.	Price Amount (₹)	Value Amount (₹)	Qty.	Price Amount (₹)	Value Amount (₹)	Qty.	Price Amount (₹)	Value Amount (₹)
1-4-2015	--	--	--	--	--	--	100	50	5,000
							300	50	15,000
2-4-2015	100	55	5,500	--	--	--	100	50	5,000
							300	50	15,000
							100	55	5,500
6-4-2015	--	--	--	300	50	15,000			
				100	55	5,500	100	50	5,000
10-4-2015	600	55	33,000	--	--	--	100	50	5,000
							600	55	33,000
13-4-2015	--	--	--	400	55	22,000	100	50	5,000
							200	55	11,000
20-4-2015	500	65	32,500	--	--	--	100	50	5,000
							200	55	11,000
							500	65	32,500
25-4-2015	--	--	--	200	55	11,000	100	50	5,000
				400	65	26,000	100	65	6,500
10-5-2015	800	70	56,000	--	--	--	100	50	5,000
							100	65	6,500
							800	70	56,000
12-5-2015	--	--	--	100	65	6,500	100	50	5,000
				400	70	28,000	400	70	28,000
13-5-2015	--	--	--	200	70	14,000	100	50	5,000
							200	70	14,000
15-5-2015	500	75	37,500	--	--	--	100	50	5,000
							200	70	14,000
							500	75	37,500
12-6-2015	--	--	--	200	70	14,000	100	50	5,000
				200	75	15,000	300	75	22,500
15-6-2015	300	80	24,000	--	--	--	100	50	5,000
							300	75	22,500
							300	80	24,000





**Stores Ledger Account [under Base Stock through LIFO Method]**

Date	Receipts			Issue			Balance		
	Qty.	Price Amount (₹)	Value Amount (₹)	Qty.	Price Amount (₹)	Value Amount (₹)	Qty.	Price Amount (₹)	Value Amount (₹)
1-4-2015	--	--	--	--	--	--	100	50	5,000
							300	50	15,000
2-4-2015	100	55	5,500	--	--	--	100	50	5,000
							300	50	15,000
							100	55	5,500
6-4-2015	--	--	--	100	55	5,500			
				300	50	15,000	100	50	5,000
10-4-2015	600	55	33,000	--	--	--	100	50	5,000
							600	55	33,000
13-4-2015	--	--	--	400	55	22,000	100	50	5,000
							200	55	11,000
20-4-2015	500	65	32,500	--	--	--	100	50	5,000
							200	55	11,000
							500	65	32,500
25-4-2015	--	--	--	500	65	32,500	100	50	5,000
				100	55	5,500	100	55	5,500
10-5-2015	800	70	56,000	--	--	--	100	50	5,000
							100	55	5,500
							800	70	56,000
12-5-2015	--	--	--	500	70	35,000	100	50	5,000
							100	55	5,500
							300	70	21,000
13-5-2015	--	--	--	200	70	14,000	100	50	5,000
							100	55	5,500
							100	70	7,000
15-5-2015	500	75	37,500	--	--	--	100	50	5,000
							100	55	5,500
							100	70	7,000
							500	75	37,500
12-6-2015	--	--	--	400	75	30,000	100	50	5,000
							100	55	5,500
							100	70	7,000
							100	75	7,500
15-6-2015	300	80	24,000	--	--	--	100	50	5,000
							100	55	5,500
							100	70	7,000
							100	75	7,500
							300	80	24,000



## Other Important concepts under Materials

### 1. Valuation of Work-in-Progress

Unlike closing stock of finished goods, which is valued at cost or market price, whichever is lower, work-in-progress is always valued on the basis of cost. The problem arises whether overheads should be included in the costs of work-in-progress.

There are three ways of valuing work-in-progress.

#### (a) At Prime Cost

This is a conservative method of valuation. Overheads are not added to prime cost for valuing work-in-progress. As a result of the exclusion of overheads, the cost of the subsequent period is understated and the cost of production for the current period is inflated to that extent.

#### (b) Prime Cost plus Variable Overheads

Under Marginal Costing method, work-in-progress is valued at prime cost plus variable overheads. Fixed overheads are excluded on the basis that these are period costs and should be recovered from revenue, i.e., sales, only.

#### (c) At Total Cost

The valuation is done at full costs inclusive of both variable and fixed overheads. The logic behind this method is that work-in-progress should carry the proportionate cost of the overheads and cost of production of completed items should not be burdened. This method is most commonly used.

### 2. Abnormal and Normal Wastage of Materials

Wastage may be classified as normal or abnormal according to the circumstances.

Normal wastage denotes that part of the wastage which is generally bound to arise in a manufacturing process on account of evaporation, shrinkage of basic raw materials or on account of typical manufacturing process being involved. Usually such wastage remains within certain normal ratio or percentage of the input.

On the other hand, abnormal wastage is that loss which does not arise in the ordinary course of manufacturing process but is the result of certain adverse circumstances such as power failure, major breakdown of machinery non-availability of the basic raw materials, etc. It is generally not possible to estimate the extent of such wastage before as they are much more than the normal ratio/percentage of loss compared to the input of basic materials.

Since the normal wastage of the materials is an unavoidable and uncontrollable issue, it should be recovered through good production. The cost of such normal wastages will be recovered as production overhead and apportioned on the number of units produced. Necessary allowance should however be made for any amount which the wastage should realize when it is disposed of. On the contrary, the cost of abnormal wastage should be separately collected and charged off to the Costing Profit and Loss Account so as not to vitiate the Production Cost of good units produced.

### 3. Waste

**Definition :** This is the residue such a smoke, dust, gases, slag, etc., which arises in course of manufacturing process and practically no measurable sale or utility value. In certain types of processes and operations, some material physically disappears on account of shrinkage, evaporation etc., with the result that the quantity of the output is less than the input. Such wastage is termed invisible waste where the residual instead of fetching any value, creates a problem for its dispose which entails further costs. Special arrangements have to be made for disposal and refuse, effluent, obnoxious gases, etc.

**Accounting:** As waste has practically no value, its accounting is relatively simple. The effect of the waste is to reduce the quantity of output; In order to arrive at the unit cost of the process, operation,



or job, the total cost of the process, etc., is distributed over the reduced output, i.e., the units of good production only. The cost of abnormal waste, should, however, be excluded from the total cost and charged to the Profit and Loss Account.

The actual waste is observed against standards and periodically reported to the management.

#### **4. Scrap**

This is also in the form of incidental material residue coming out of certain types of manufacturing processes but it is usually in small amounts and has low measurable utility or market value, recoverable without further processing. Numerous examples of scrap may be given; scrap may arise in the form of turnings, borings, trimmings, fillings, shavings etc., from metals on which machine operations are carried out; saw dust and trimmings in the timber industry; dead heads and bottom ends in foundries; and cuttings, pieces, and split in leather industries. Scrap should always be physically available unlike waste which may or may not be present in the form of a residue.

**Accounting treatment of scrap is as follows:**

##### **(a) Sales Credited to Revenue**

In this method, the scrap is not cost and its value does not, therefore, appear separately in the Cost Accounts. Only a quantitative record of the scrap returned to storeroom from the shops is maintained and the sale value realised from time to time is credited to the Profit and Loss Account as miscellaneous revenue.

##### **(b) Credit to Overhead**

In this method and in the following method the scrap is assigned a cost. The cost is usually the sale value of the scrap less selling and distribution costs. If the scrap has no ready market but has only utility or use value, and is taken as a credit to manufacturing overhead. The effect of this credit is to reduce the overhead recovery rate. When predetermined overhead rates are in use, it is more expedient to credit an estimated allowance for the scrap instead of the amount of actual scrap.

##### **(c) Credit to Jobs**

The scrap is assigned a cost and is traced to the job which yielded the scrap. This affords a reasonable amount of credit to the jobs and widely different.

##### **(d) Transfer to Other Jobs**

Scrap arising in one job may be issued for utilization in another job. Such transfers of scrap from one job to another should be affected through Material Transfer Notes. Alternatively, scrap may be returned to store room and subsequently issued to another job for utilization. The latter method is more appropriate when some further processing is required on the scrap before it can be utilised for other jobs.

#### **Control of Scrap**

Scrap is also an unavoidable residue material arising in the process of manufacture. The basic difference between scrap and waste is that while waste may not have any value, scrap must necessarily have a value, though a comparatively small one. Scrap may be sold or re-used in some process. In some industries, arising of scraps of various types in significant quantities is a regular feature and in such cases, it would be worth while having a proper administrative set-up for control of scrap. A Scrap Survey Committee may be constituted which would be responsible for such matters as (1) classifying the various types of scrap; (2) Assessing the quantum of each; and (3) Deciding upon the manner of their use or disposal.

Control of scrap should start from the designing stage of the products. At the designing stage, the type, shape and form of materials which all result in the minimum of waste or the least quantity of scrap in manufacturing process are decided. The quantity of scrap resulting from a process also depends upon the manufacturing equipment used and the efficiency of the operative who performs the work. In order to minimise scrap, production should be planned so that the best possible equipment is used and properly trained personnel are employed on the job.



## 5. Spoilage

**Definition:** When production does not come up to the standard specifications or quality it has to be rejected outright. The components or materials are so damaged in the manufacturing process that they cannot be brought back to the normal specifications by repairs or reconditioning. Some spoiled work may be sold as seconds but in most cases, the entire production is sold for small value in the form of scrap or treated as waste if it has no market value. Spoilage involves not only loss of materials but also of labour and manufacturing overhead incurred up to the stage when the spoilage incurred.

### Accounting and Control of Spoilage

Spoilage arises when the production output is damaged in such a manner and to such an extent that it cannot be used for the original purpose for which it was designed but is to be disposed off in some suitable manner without further processing. The distinction between scrap and spoiled work is that while normal scrap arises mostly as a result of the processing of materials, spoilage occurs due to some defect in operations or materials which may or may not be inherent in the manufacturing process or operation. Further, scrap has always a relatively low but some definite value, but the value of spoilage may range from low, if it is a waste, to comparatively high values if the spoilage is to be sold as seconds.

Spoilage involves not only the loss of material but also labour and manufacturing overheads.

## 6. Treatment of Packing Cost

Packing materials is of two types - primary and secondary. Primary containers are essential to put the goods in a saleable condition like ink in a bottle, jam in a jar, etc. Secondary containers are required for delivery/transportation like crates, etc., they are returnable and reusable.

The cost of primary containers should be charged off as a production overhead and included in production cost. On the other hand, the cost of secondary containers should charge as a selling and distribution overhead. The cost of reusable container should be charged when they could not be used any more due to damage, wear and tear, etc. In some cases, the primary packing materials may be made decorative with a view to promote sales, and in such a case a part of the primary packing materials should be apportioned as a selling cost.

## 7. Carriage and Cartage Expenses

Carriage and Cartage Expenses are incurred in the course of movement of materials or goods. Materials may mean direct materials or indirect materials. The treatment of the Carriage and Cartage Expenses differ with the kind of materials/goods transported. The carriage and cartage expenses relating to raw materials are treated as a part of direct materials cost and those relating to distribution of materials or finished goods are treated as distribution overhead. In case where the carriage and cartage are abnormal due to any reason the same is charged off to be costing Profit and Loss Account.

## 8. Treatment of Tools Cost

Tools may be classified as (i) large tools and (ii) small tools, large tools are normally capitalised and depreciation charged to Factory Overheads. For small tools the following treatment may apply:

- (a) Capitalization Method: In line with large tools.
- (b) Revaluation Method: At the end of the year revaluation for unused life of the tools is made and the difference between original cost and revalued cost is charged as factory overheads.
- (c) Write-off-Method: Whenever such small tools are issued the department is debited with the cost. Alternatively cost of tools issued during a period is accumulated and distributed to various departments on some suitable basis, e.g., hours worked.



### 9. Treatment of Discount Allowed by Suppliers for Bulk Purchases

Discounts Allowed on purchases are of two types, viz., Cash Discount and Quantity and Trade Discount. Cash Discount is usually allowed for prompt payment and the Quantity and Trade Discount for heavy purchases. The amount of the latter discount is already credited in the invoice and the net landed cost of the material exclusive of the discount is considered as the material cost.

### 10. Treatment of Variance Detected at Stock Taking

If the variances are due to normal causes, i.e., due to normal dry age, shrinkage, evaporation, etc., these are valued at the ruling ledger rates of the items of material concerned and the amount is taken as an item of stores overhead and recovered from production as a percentage of direct material cost consumed. If the variances are due to abnormal causes, viz., theft, fraud, misappropriation etc., these are valued by writing off to Costing Profit and Loss Account.

#### Illustration 7

Prepare a Stores Ledger Account from the following information adopting FIFO method of pricing of issues of materials.

- 2016 March
1. Opening Balance 500 tonnes @ ₹200
  3. Issue 70 tonnes
  4. Issue 100 tonnes
  5. Issue 80 tonnes
  13. Received from suppliers 200 tonnes @ ₹190
  14. Returned from Department A 15 tonnes.
  16. Issued 180 tonnes
  20. Received from supplier 240 tonnes @ ₹195
  24. Issue 300 tonnes
  25. Received from supplier 320 tonnes @ ₹200
  26. Issue 115 tonnes
  27. Returned from Department B 35 tonnes
  28. Received from supplier 100 tonnes @ ₹200

**Solution:**

#### Stores Ledger Account [FIFO Method]

Date	Receipts			Issue			Balance		
	Qty.	Price Amount (₹)	Value Amount (₹)	Qty.	Price Amount (₹)	Value Amount (₹)	Qty.	Price Amount (₹)	Value Amount (₹)
2016 March 1	--	--	--	--	--	--	500	200	1,00,000
March 3	--	--	--	70	200	14,000	430	200	86,000
March 4	--	--	--	100	200	20,000	330	200	66,000
March 5	--	--	--	80	200	16,000	250	200	50,000
March 13	200	190	38,000	--	--	--	250	200	50,000
							200	190	38,000
March 14	15	200	3,000	--	--	--	250	200	50,000



							200	190	38,000
							15	200	3,000
March 16	--	--	--	180	200	36,000	70	200	14,000
							200	190	38,000
							15	200	3,000
March 20	240	195	46,800	--	--	--	70	200	14,000
							200	190	38,000
							15	200	3,000
							240	195	46,800
March 24	--	--	--	70	200	14,000	--	--	--
				200	190	38,000	--	--	--
				15	200	3,000	--	--	--
				15	195	2,925	225	195	43,875
March 25	320	200	64,000	--	--	--	225	195	43,875
							320	200	64,000
March 26	--	--	--	115	195	22,425	110	195	21,450
							320	200	64,000
March 27	35	195	6,825	--	--	--	110	195	21,450
							320	200	64,000
							35	195	6,825
March 28	100	200	20,000	--	--	--	110	195	21,450
							320	200	64,000
							35	195	6,825
							100	200	20,000

### Illustration 8

From this information provided as under, you are required to prepare a statement showing how the issues would be priced if LIFO method is followed.

- 2016 Feb:
1. Opening Balance 100 units at ₹10 each.
  2. Received 200 units at ₹10.50 each.
  3. Received 300 units at ₹10.60 each.
  4. Issued 400 units to Job A vide M.R.No.015.
  6. Issued 120 to Job B vide M.R.No.020.
  7. Received 400 units at ₹11 each.
  8. Issued 200 units to Job B vide M.R.No.031
  12. Received 300 units at ₹11.40 each.
  13. Received 200 units at ₹11.50 each.
  17. Issued 400 units to Job D vide M.R. No. 040.



**Solution:**

**Stores Ledger Account [LIFO Method]**

Date	Receipts			Issue			Balance		
	Qty.	Price Amount (₹)	Value Amount (₹)	Qty.	Price Amount (₹)	Value Amount (₹)	Qty.	Price Amount (₹)	Value Amount (₹)
2016 Feb 1	--	--	--	--	--	--	100	10.00	1,000
Feb 2	200	10.50	2,100	--	--	--	100	10.00	1,000
							200	10.50	2,100
Feb 3	300	10.60	3,180	--	--	--	100	10.00	1,000
							200	10.50	2,100
							300	10.60	3,180
Feb 4	--	--	--	300	10.6	3,180	100	10.00	1,000
				100	10.50	1,050	100	10.5	1,050
Feb 6	--	--	--	100	10.50	1050	--	--	--
				20	10.00	200	80	10.00	800
Feb 7	400	11.00	4,400	--	--	--	80	10.00	800
							400	11.00	4,400
Feb 8	--	--	--	200	11.00	2200	80	10.00	800
							200	11.00	2,200
Feb 12	300	11.40	3,420	--	--	--	80	10.00	800
							200	11.00	2,200
							300	11.40	3,420
Feb 13	200	11.50	2,300	--	--	--	80	10.00	800
							200	11.00	2,200
							300	11.40	3,420
							200	11.50	2,300
Feb 17	--	--	--	200	11.50	2300	80	10.00	800
				200	11.40	2280	200	11.00	2,200
							100	11.40	1,140

**Illustration 9**

Prepare Stores Ledger Account showing pricing of material issues on Replacement Price basis from the following particulars.

Opening balance 400 units at ₹4 each

10-3-2016 Received 100 units at ₹4.10 each

15-3-2016 Issued 300 units to Job XY vide M.R.No.14 17-3-2016 Received 200 units at ₹4.30 each

20-3-2016 Issued 250 units to Job AB vide M.R.No.20

25-3-2016 Received 400 units @ ₹4.50 each



26-3-2016 Issued 200 units to Job JK vide M.R.No.27 27-3-2016 Received 100 units @₹4.60 each.

30-3-2016 Issued 300 units to Job PQ vide M.R.No.32.

Replacement Price on various dates :  
 15-3-2016 ₹4.20  
 20-3-2016 ₹4.40  
 26-3-2016 ₹4.60 &  
 30-3-2016 ₹4.80.

**Solution:****Stores Ledger Account [Replacement Price Basis]**

Date	Receipts			Issue			Balance		
	Qty.	Price Amount (₹)	Value Amount (₹)	Qty.	Price Amount (₹)	Value Amount (₹)	Qty.	Price Amount (₹)	Value Amount (₹)
2016 Mar 1	--	--	--	--	--	--	400	4.00	1,600
10-3-2016	100	4.10	410	--	--	--	500	4.02	2,010
15-3-2016	--	--	--	300	4.20	1260	200	3.75	750
17-3-2016	200	4.30	860	--	--	--	400	4.03	1,610
20-3-2016	--	--	--	250	4.40	1,100	150	3.40	510
25-3-2016	400	4.50	1,800	--	--	--	550	4.20	2,310
26-3-2016	--	--	--	200	4.60	920	350	3.97	1,390
27-3-2016	100	4.60	460	--	--	--	450	4.11	1,850
30-3-2016	--	--	--	300	4.80	1,440	150	2.7310	410

**Illustration 10**

Stocks are issued at a standard price and the following transactions occurred for a specific material:

1st January	Opening Stock	10	tonnes at ₹240 per ton
4th January	Purchased	5	tonnes at ₹260 per ton
5th January	Issued	3	tons
12th January	Issued	4	tons
13th January	Purchased	3	tons at ₹250 per ton
19th January	Issued	4	tons
26th January	Issued	3	tons
30th January	Purchased	4	tons at ₹280 per ton
31st January	Issued	3	tons.

The debit balance of price variation on 1st January was ₹20. Show the stock account for the material for the month of January, indicating how you would deal with the difference in material price variance, when preparing the Profit and Loss Account for the month.





**Solution:**

$$\begin{aligned} \text{Standard Price} &= \frac{(240 \times 10) + 20}{10} \\ &= ₹ 242 \end{aligned}$$

**Stores Ledger Account**

Date	Receipts			Issue			Balance	
	Qty.	Price Amount (₹)	Value Amount (₹)	Qty.	Price Amount (₹)	Value Amount (₹)	Qty.	Value Amount (₹)
1st January	--	--	--	--	--	--	10	2,400
4th January	5	260	1,300	--	--	--	15	3,700
5th January	--	--	--	3	242	726	12	2,974
12th January	--	--	--	4	242	968	8	2,006
13th January	3	250	750	--	--	--	11	2,756
19th January	--	--	--	4	242	968	7	1,788
26th January	--	--	--	3	242	726	4	1,062
30th January	4	280	1,120	--	--	--	8	2,182
31st January	--	--	--	3	242	726	5	1,456

Material price variance is ₹ 246 which is to be transferred to debit of costing P & L A/c.

**Working :**

$$\begin{aligned} \text{Stock at standard price} &= 5 \times 242 &&= 1,210 \\ \text{Material Price Variance} &= 1,210 - 1,456 &&= 246 \text{ (A)} \end{aligned}$$

**Illustration 11**

Receipts and issues of an item of stores are made as follows: There was no balance before 9th January.

	Receipts		Issues
	Quantity	Price (₹)	Quantity
January 9th	10	17.0	
19th	25	10.0	
20th			10
29th			20
30th	15	8.0	
February 13th	20	12.0	
27th	10	16.9	
28th			40
March 30th	20	20.0	
31st			20

(i) What is the simple average of February receipts ?



- (ii) What are the moving monthly simple average price for January -February and February-March?
- (iii) If a weighted average is used for pricing issues how does the value of the balance in stock change during January?
- (iv) If a weighted average price is calculated at the end of each month and is then used for pricing the issued of that month, what will be the value of the month-end balance?

**Solution:****(i) Simple Average Price of February Receipts.**

$$\text{Simple Average Price of February Receipts} = (12 + 16.9) / 2 = ₹ 14.45$$

**(ii) Simple Average Price of January Receipts**

$$\text{Simple Average Price of January Receipts} = (17 + 10 + 8) / 3 = ₹ 11.67$$

$$\text{Moving monthly average for Jan-Feb} = (11.67 + 14.45) / 2 = ₹ 13.06$$

$$\text{Moving monthly average for Feb-March} = (14.45 + 20) / 2 = ₹ 17.225$$

**(iii) Stores Ledger Account (under weighted average method for January)**

Date	Receipts			Issue			Balance	
	Qty.	Price Amount (₹)	Value Amount (₹)	Qty.	Price Amount (₹)	Value Amount (₹)	Qty.	Value Amount (₹)
Jan 9th	10	17	170	--	--	--	10	170
Jan 19th	25	10	250	--	--	--	35	420
Jan 20th	--	--	--	10	12	120	25	300
Jan 29th	--	--	--	20	12	240	5	60
Jan 30th	15	8	120	--	--	--	20	180

**(iv) Calculation of the Value of month-end balance**

Date	Quantity	Value
Jan 9th	10	170
Jan 19th	25	250
Jan 30th	15	120
	50	540
(-) Issues	30 (10.8)	324
Jan-Balance	20	216
Feb 13th	20	240
Feb 27th	10	169
Feb Balance	50	625
(-) Issues	40 (12.5)	500
	10	125
March 30th	20	400
	30	525
(-) Issues	20 (17.5)	350
Balance	10	175



**Illustration 12**

Two components A and B are used as follows:

Normal usage = 50 per week each

Re-order quantity = A- 300; B-500

Maximum usage = 75 per week each

Minimum usage = 25 per week each

Re-order period: A - 4 to 6 weeks; B - 2 to 4 weeks

Calculate for each component

(a) Re-order level; (b) Minimum level; (c) Maximum level; (d) Average stock level.

**Solution:**

	Particulars	A	B
a)	Reorder Level [Max. Consumption × Max. Re-order Period]	450 units (75 × 6)	300 units (75 × 4)
b)	Minimum Level [ROL – (Normal Consumption × Normal Re-order period)]	200 units [450 – (50×5)]	150 units [300 – (50×3)]
c)	Maximum Level [ROL + ROQ – (Min. Consumption × Min Re-order period)]	650 units [450 + 300 – (25×4)]	750 units [300 + 500 – (25 × 2)]
d)	Average Stock Level [Min. Level + Max. Level] / 2 or [Min. Level + ½ × ROQ]	425 units [200 + 650] / 2 (or) or 350 units 200 + ½ (300)	450 units [150 + 750] / 2 (or) or 400 units 150 + ½ (500)

**Illustration 13**

Anil company buys its annual requirement of 36,000 units in six installments. Each unit costs ₹1 and the ordering cost is ₹25. The inventory carrying cost is estimated at 20% of unit value. Find the total annual cost of the existing inventory policy. How much money can be saved by using E.O.Q?

**Solution:**

$$\begin{aligned}
 \text{EOQ} &= \sqrt{\frac{2 \cdot \text{A.O}}{C}} \\
 &= \sqrt{\frac{2 \times 36,000 \times 25}{1 \times 20\%}} \\
 &= \sqrt{\frac{18,00,000}{0.2}} \\
 &= 3,000 \text{ units}
 \end{aligned}$$

**Statement Showing computation of comparative inventory cost of existing policy and proposed EOQ policy:**

	Particulars	Existing Policy		EOQ	
(i)	Purchase Cost	(36000 x 1)	36000	(36000 x 1)	36000
(ii)	Ordering Cost	[36000/6000 x 25]	150	[36000/3000 x 25]	300
(iii)	Carrying Cost	[1/2 x 6000 x 1 x 20%]	600	[1/2 x 3000 x 1 x 20%]	300
			36,750		36,600

Saving by using EOQ = 36,750 – 36,600 = ₹ 150

**Illustration 14**

The annual demand for an item is 3,200 units. The units cost is ₹6 and inventory carrying charges is 25% p.a. If the cost of one procurement is ₹150, determine:

- (a) E.O.Q (b) No. of orders per year (c) Time between two consecutive orders.

**Solution:**

$$\begin{aligned}
 \text{(a) EOQ} &= \sqrt{\frac{2.A.O}{C}} \\
 &= \sqrt{\frac{2 \times 3,200 \times 150}{6 \times 25\%}} \\
 &= \sqrt{\frac{9,60,000}{1.5}} \\
 &= 800 \text{ units}
 \end{aligned}$$

$$\text{(b) No. of orders per year} = A / \text{EOQ} = 3200 / 800 = 4 \text{ orders} \quad (A = \text{Annual demand})$$

$$\begin{aligned}
 \text{(c) Time between two consecutive orders} &= \text{No. of months in years} / \text{No. of orders} \\
 &= 12/4 = 3 \text{ Months}
 \end{aligned}$$

**Illustration 15**

A company manufactures a special product which requires a component 'Alpha'. The following particulars are collected for the year 2015.

- |    |                          |                 |
|----|--------------------------|-----------------|
| 1. | Annual demand of Alpha   | 8,000 units     |
| 2. | Cost of placing an order | ₹ 200 per order |
| 3. | Cost per unit of Alpha   | ₹ 400           |
| 4. | Carrying cost % p.a.     | 20%             |

The company has been offered a quantity discount of 4% on the purchase of 'Alpha' provided the order size is 4,000 components at a time.

**Required:**

- (a) Compute the economic order quantity.  
 (b) Advise whether the quantity discount offer can be accepted.



**Solution:**

**(a) Calculation of Economic Order Quantity**

$$EOQ = \sqrt{\frac{2AO}{C}}$$

$$EOQ = \sqrt{\frac{2 \times 8,000 \times 200}{400 \times 20\%}}$$

= 200 units

**(b) Evaluation of Profitability of Different Options of Order Quantity**

(i) When EOQ is ordered

Purchase Cost	(8,000 units x ₹ 400)	32,00,000
Ordering Cost	[(8,000 units / 200 units) x ₹ 200]	8,000
Carrying Cost	(200 units x ₹ 400 x ½ x 20/100)	8,000
<b>Total Cost</b>		<b>32,16,000</b>

(ii) When quantity discount is accepted

Purchase Cost	(8,000 units x ₹ 384)	30,72,000
Ordering Cost	[(8,000 units / 4000 units) x ₹ 200]	400
Carrying Cost	(4000 units x ₹ 384 x ½ x 20/100)	1,53,600
<b>Total Cost</b>		<b>32,26,000</b>

**Advise:**

The total cost of inventory is lower if EOQ is adopted. Hence, the company is advised not to accept the quantity discount.

**Illustration 16**

From the following particulars with respect to a particular item of materials of a manufacturing company, calculate the best quantity to order:

<b>Ordering quantities (tonne)</b>	<b>Price per ton Amount (₹)</b>
Less than 250	6.00
250 but less than 800	5.90
800 but less than 2,000	5.80
2,000 but less than 4,000	5.70
4,000 and above	5.60

The annual demand for the material is 4,000 tonnes. Stock holding costs are 20% of material cost p.a. The delivery cost per order is ₹6.00

**Solution:****Statement showing computation of total inventory cost at different order sizes (Annual Demand = 4000 tonnes)**

	Particulars	Ordering Quantities				
		200	250	800	2000	4000
(i)	Purchasing cost	24000 (4000×6)	23600 (4000×5.9)	23200 (4000×5.8)	22800 (4000×5.7)	22400 (4000×5.6)
(ii)	No. of orders	20	16	5	2	1
(iii)	Ordering Cost (₹ 6)	120	96	30	12	6
(iv)	Average size of order	100	125	400	1000	2000
(v)	Inventory Carrying cost per unit	1.2 (6×20%)	1.18 (5.9×20%)	1.16 (5.8×20%)	1.14 (5.7×20%)	1.12 (5.6×20%)
(vi)	Inventory carrying cost (iv x v)	120	147.5	464	1140	2240
(vii)	Total Inventory Cost (iii + i + vi)	24240	23843.5	23694	23952	24646

For the above computations the best quantity to order is 800 units.

**Illustration 17**

The particulars relating to 1,200 kgs. of a certain raw material purchased by a company during June, were as follows:-

Lot prices quoted by supplier and accepted by the Company for placing the purchase order :

Lot upto 1,000 kgs. @ ₹22 per kg.

Between 1,000 - 1,500 kgs, @ ₹20 per kg.

Between 1500 -2000 kgs. @ ₹18 per kg.

Trade discount – 20%.

Additional charge for containers @ ₹10 per drum of 25 kgs.

Credit allowed on return of containers, @ ₹8 per drum.

GST at 12% on raw material and 5% on drums.

Total freight paid by the purchaser ₹240/-

Insurance at 2.5% (on net invoice value) paid by the purchaser.

Stores overhead applied at 5% on total purchase cost of material.

The entire quantity was received and issued to production.

The containers are returned in due course. Draw up a suitable statement to show :-

- Total cost of material purchased and
- Unit cost of material issued to production.



**Solution:**

**Statement showing computation of total cost of material purchased and unit cost of material issued for production.** Amount (₹)

Particulars	Unit Cost	Total Cost (1,200 kgs)
Basic price of material	20.00	24,000.00
(-) Trade discount (20%)	4.00	4,800.00
	16.00	19,200.00
(+) Drum charges (1,200/25 x 10)	0.40	480.00
(+) GST 19,200 x 12% = 2,304 480 x 5% = 24 = 2,328	1.94	2,328.00
Net Invoice Value	18.34	22,008.00
(+) Insurance (22,008 x 2.5%)	0.4585	550.20
(+) Freight paid	0.2000	240.00
	18.9985	22,798.20
(-) Credit for drums returned (1,200 / 25 x 8)	0.3200	384.00
Total Cost of Material Purchased	18.6785	22,414.20
(+) Stores overhead (22,414.20 x 5%)	0.9339	1,120.71
Material cost issued to production	19.6124	23,534.91

**Illustration 18**

From the following data for the year ended 31st Dec, 2016, calculate the inventory turnover ratio of the two items, and put forward your comments on them.

	Material A Amount (₹)	Material B Amount (₹)
Opening stock on 1-1-2016	10,000	9,000
Purchase during the year 2016	52,000	27,000
Closing on 31-12-2016	6,000	11,000

**Solution:**

$$\text{Material Inventory Turnover Ratio} = \frac{\text{Cost of Material Used}}{\text{Average Stock}}$$

$$\begin{aligned} \text{For A} &= \frac{10,000 + 52,000 - 6,000}{(10,000 + 6,000)/2} \\ &= 7 \text{ times} \end{aligned}$$

$$\begin{aligned} \text{For B} &= \frac{9,000 + 27,000 - 11,000}{(9,000 + 11,000)/2} \\ &= 25,000 / 10,000 \\ &= 2.5 \text{ times} \end{aligned}$$



Material Inventory turnover ratio indicates the efficiency of the management with which they are able to utilize their inventory. It indicates the existence or non-existence of non moving items, dormant items, slow moving items etc. in inventory. If the ratio is high, the efficiency is said to be high and on the other hand if the ratio is low, the efficiency is said to be low.

In view of above, in the instant case, we may say that Material A used better than Material B.

### Illustration 19

From the details given below, calculate:

- (i) Re-ordering level
- (ii) Maximum level
- (iii) Minimum level
- (iv) Danger level

Re-ordering quantity is to be calculated on the basis of following information:

- (a) Cost of placing a purchase order is ₹ 20
- (b) Number of units to be purchased during the year is 5,000
- (c) Purchase price per unit inclusive of transportation cost is ₹ 50
- (d) Annual cost of storage per units is ₹ 5
- (e) Details of lead time:                      Average 10 days, Maximum 15 days, Minimum 6 days.  
For emergency purchases 4 days
- (f) Rate of consumption:                      Average: 15 units per day,  
Maximum: 20 units per day

### Solution:

$$\text{EOQ} = \sqrt{\frac{2 \times 5,000 \times 20}{5}}$$

$$= 200 \text{ units}$$

$$\text{Min. Rate of Consumption} = (15 \times 2) - 20$$

$$= 10 \text{ units per day}$$

(i) Re-order Level	= Maximum usage per period x Maximum Re-order Period
(ROL)	= 20 units per day x 15 days = 300 units
(ii) Maximum level	= ROL + ROQ – (Min. Rate of Consumption x Min. Re-order Period)
	= 300 units + 200 units – (10 units per day x 6 days)
	= 440 units
(iii) Minimum level	= ROL – (Average Rate of Consumption x Average Re-order Period)
	= 300 units – (15 units per day x 10 days)
	= 150 units
(iv) Danger level	= Average Consumption x Lead time for Emergency Purchases
	= 15 units per day x 4 days = 60 units





**Illustration 20**

M/s Tubes Ltd. are the manufacturers of picture tubes for T.V. The following are the details of their operation during the year 2015:

Average monthly market demand	2,000 Tubes
Ordering Cost	₹100 per order
Inventory carrying cost	20% per annum
Cost of tubes	₹ 500 per tube
Normal usage	100 tubes per week
Minimum usage	50 tubes per week
Maximum usage	200 tubes per week
Lead time to supply	6 – 8 weeks

**Compute from the above:**

- (i) Economic order quantity. If the supplier is willing to supply quarterly 1,500 units at a discount of 5% is it worth accepting?
- (ii) Re-order level
- (iii) Minimum level of stock
- (iv) Maximum level of stock

**Solution:**

A = Annual usage of tubes = Normal usage per week x 52 weeks  
 = 100 tubes x 52 weeks = 5,200 tubes  
 O = Ordering cost per order = ₹ 100 per order  
 C = Inventory carrying cost per unit per annum  
 = 20% x ₹ 500 = ₹ 100 per unit, per annum

**Economic Order Quantity:**

$$E.O.Q = \sqrt{\frac{2AO}{C}} = \sqrt{\frac{2 \times 5,200 \times 100}{100}} = 102 \text{ tubes (approx.)}$$

**If the supplier is willing to supply 1,500 units at a discount of 5% is it worth accepting?**

Total cost (when order size is 1,500 units) = Cost of 5,200 units + Ordering cost + Carrying cost.

$$5,200 \text{ units} \times ₹ 475 + \left( \frac{5,200 \text{ units}}{1,500 \text{ units}} \times ₹ 100 \right) + (1,500 \text{ units} \times 20\% \times ₹ 475) \div 2$$

$$= ₹ 24,70,000 + ₹ 346.67 + ₹ 71,250$$

$$= ₹ 25,41,596.67$$

**Total cost (when order size is 102 units)**

$$= 5,200 \text{ units} \times ₹ 500 + \left( \frac{5,200 \text{ units}}{102 \text{ units}} \times ₹ 100 \right) + (102 \text{ units} \times 20\% \times ₹ 500) \div 2$$

$$= ₹ 26,00,000 + ₹ 5,098.03 + ₹ 5,100 = ₹ 26,10,198.03$$



Since the total cost under quarterly supply of 1,500 units with 5% discount is lower than that when order size is 102 units, the offer should be accepted. While accepting this offer capital blocked on order size of 1,500 unit per quarter has been ignored.

**Re-order Level:**

= Maximum Consumption × Maximum Re-order Period

= 200 units × 8 weeks = 1,600 units.

**Minimum level of Stock:**

= Re-order Level - Normal Usage × Average Re-order Period

= 1,600 units - 100 units × 7 weeks = 900 units.

**Maximum level of Stock:**

= Re-order Level + Re-order Quantity – Min. Usage x Min.-Re-order Period

= 1,600 units + 102 units – 50 units x 6 weeks

= 1,402 units.

## GLOSSARY

**ABC Analysis:** A B C Analysis is the analysis of a range of items, e.g. stock levels, customers, etc. into three groups, viz. A = most important, B = important, C = less important.

**Bin Card:** Bin Card is a prime entry record of the quantity of stocks, kept on in/out/balance, held in designated storage areas.

**Danger Level:** Danger Level is the level where only emergency materials are issued and normal issue of materials is stopped.

Danger Level = Normal Rate of Consumption × Maximum Re-order period for emergency purchases.

**Defectives:** Defectives are the goods that can be rectified and turned out as good units by using additional labour or other services.

**Direct Material Cost:** Direct Material Cost is the cost of materials entering into and becoming constituent elements of a product or saleable service and which can be identified separately in product costs.

**First in First Out (FIFO):** FIFO is a method of pricing material issues using the oldest purchase price first.

**Goods Received Note:** Goods Received Note is a document prepared by the Goods Receiving Department that unpacks the goods received and verify the quantities and other details.

**Indirect Material Cost:** Indirect Material Costs are the materials costs which are not charged directly to a product, e.g. cotton waste, cleaning materials, etc.

**Just-in-Time (JIT) Inventory System:** Just-in-Time (JIT) Inventory System is a system in which materials are purchased when it is actually needed for production purpose. It is a Japanese philosophy which is used for managing all types of inventory, purchase and production functions in an organisation. The main purpose of this philosophy is to reduce inefficiency and unproductive time and cost in the production process.

**Last in First Out (LIFO):** LIFO is a method of pricing material issues using the last purchase price first.



**Material Control:** Material Control is the systematic control on procurement, storage and usage of materials with a view to maintaining even flow of materials and avoiding at the same time the excessive investment in inventories.

**Material Return Note:** Material Return Note is a document accompanied with the goods returned from the factory back to the stores.

**Material Requisition Note:** Material Requisition Note is a document used to authorise and record the issue of materials from the store.

**Material Transfer Note:** Material Transfer Note is a document prepared when the material is transferred from one department to another.

**Maximum Level:** Maximum Level is the maximum limit up to which the stock can be stored at any time.  

$$\text{Maximum Level} = \text{Re-order Level (ROL)} + \text{Re-order quantity (ROQ)} - (\text{Minimum Rate of Consumption} \times \text{Minimum Re-order Period})$$

**Minimum Level:** Minimum Level is the minimum quantity that must be retained in stock.  

$$\text{Minimum Level} = \text{Re-order Level (ROL)} - (\text{Normal rate of Consumption} \times \text{Normal Re-order Period})$$

**Purchase Order:** Purchase Order is a request in writing to the supplier to supply certain specified materials at the specified rates and within a specified period.

**Purchase Requisition:** Purchase Requisition is a document prepared by the store keeper to initiate the process of purchase by the purchasing department.

**Re-order Level:** Re-order Level is the quantity of materials fixed in advance at which level the stock should be re-ordered.

$$\begin{aligned} \text{Re-order Level} &= \text{Minimum Level} + \text{Consumption During Lead Time} \\ &= \text{Minimum Level} + (\text{Normal Rate of Consumption} \times \text{Normal Re-order Period}) \end{aligned}$$

Or

$$\text{Re-order Level} = \text{Maximum Rate of Consumption} \times \text{Maximum Re-order Period (Lead Time)}$$

**Scrap:** Scrap is the discarded material which has some recovery value and which is usually either disposed of without further treatment or reintroduced into the production process in place of raw material.

**Simple Average Price:** Simple Average Price is the average price of issuing materials which is computed by dividing the total of all units rate by the number of units.

$$\text{Simple Average Issue Price} = \text{Total of unit prices of each purchase} \div \text{Total number of units}$$

**Spoilage:** Spoilage is the goods damaged beyond rectification to be sold without further processing.

**Stores Ledger:** Stores Ledger is a ledger containing a separate account for each item of material and component stored giving details of the receipts, issues and balance both in terms of quantity and value.

**Vital, Essential and Desirable (VED) Analysis:** VED analysis is an inventory analysis in which inventories are classified on the basis of its criticality for the production function and final product.

**Wastage:** Wastage is the portion of basic raw material lost in processing having no recoverable value.

**Weighted Average Price:** Weighted Average Price is a method of pricing material issues using a price calculated by dividing the total cost of material in stock by the total quantity in stock.

$$\text{Weighted Average Issue Price} = \text{Total Cost of Materials in Stock} \div \text{Total Quantity of Materials in Stock}$$



**SELF EXAMINATION QUESTIONS:**

1. What is the prime objective of material control? It is said that in any system of material control there are always two counteracting or opposing factors. What are these and why do these factors arise?
2. What are the principal forms generally required to be used in connection with purchasing and receiving of stores? Briefly describe them and design any one of the forms that are used.
3. Explain the meaning and importance of material control and mention the main requisites of an adequate system of material control.
4. What is a purchase order? To whom should the copies of a purchase order be sent and why? Give a specimen form of purchase order, assuming the particulars to be filled in.
5. Enumerate the advantages and disadvantages of a centralised stores system.
6. What is Re-ordering Level? Explain its relationships with Maximum and Minimum Stock Levels. What are the factors to be considered in fixing Re-ordering Level and Quantity? Under what circumstances would you recommend revision of levels?
7. What is Bin Card? Give a specimen form of the Bin Card and discuss its utility.
8. "The Perpetual Inventory System is an Integral part of material control". Discuss this statement by bringing out briefly the salient features and the advantages of this system.
9. What is Economic Order Quantity? How is it calculated?
10. What are the main factors which you would consider before selecting a method of pricing material issues?
11. What is meant by Bill of Materials? When will you recommend drawal of stores under Bill of Materials as opposed to individual requisition?
12. What are the stores that normally come under "Packing Materials"? What are the major classifications of packing expenses and how they are treated in cost?
13. How would you deal with the following in Cost Accounts?
  - (a) Packing cost
  - (b) Cost of Tools
14. Write short notes on the following:
  - (a) ABC analysis.
  - (b) VED analysis.
  - (c) Treatment of Scrap in costing.
  - (d) Valuation of work in progress.
  - (e) Moving Average Price Method of material issue valuation.
  - (f) Just in time
  - (g) Bin Card vs. Stores Ledger
  - (h) Principles of valuation of receipt of material as per CAS – 6.
  - (i) Re-order level



- (j) Maximum stock level
  - (k) Minimum stock level
15. How normal and abnormal loss of material are treated in Cost Accounts?
16. Discuss the concept of ABC Analysis as a measure of inventory control?
17. Which of the following statements are true?
- (a) Perpetual inventory system enables management to ascertain stock at any time without physical inventory being taken.
  - (b) Continuous stock taking is not an essential feature to the perpetual inventory system.
  - (c) Bin card is a record of both quantities and value.
  - (d) VED analysis is used primarily for control of spare parts.
  - (e) ABC analysis is not based on the concept of selection inventory management.
  - (f) Stores ledger is maintained in the stores department.
  - (g) Purchase requisition is usually prepared by the storekeeper.
  - (h) In centralised purchasing all purchases are made by the purchasing department.
  - (i) Weighted average method of pricing issue of materials involves adding all the different prices and dividing by the number of such prices.
  - (j) Material returned note is prepared to keep a record of return of surplus materials to stores.
  - (k) Under the average price method of valuing material issues, a new issue price is determined after each purchase.

(Ans: [True: a, d, g, h, j and k]; [False : b, c, e, f, i])

### PRACTICE PROBLEMS

18. Your factory buys and used a component for production at ₹ 10 per piece. Annual requirement is 2,000 numbers. Carrying cost of inventory is 10% p.a. and ordering cost is ₹ 40 per order. The purchase manager argues that as the ordering cost is very high, it is advantageous to place a single order for the entire annual requirement. He also says that if we order 2,000 pieces at a time we can get a 3% discount from the supplier. Evaluate this proposal and makes your recommendations.

**Ans:** Proposal of the purchase manager not acceptable because it increases cost by ₹ 10; buy 400 units (i.e., EOQ) at a time is not economical.

19. P Ltd. uses three types of materials A, B and C for production of 'X', the final product. The relevant monthly date for the components are as given below:

	A	B	C
Normal usage (in units)	200	150	180
Minimum usage (in units)	100	100	90
Maximum usage (in units)	300	250	270
Re-order Quantity (in units)	750	900	720
Re-order period (in months)	2 to 3	3 to 4	2 to 3

**Calculate for each component:**

- (a) Re-order Level
- (b) Minimum Level
- (c) Maximum Level
- (d) Average Stock Level

**Ans:**

A	900 units	1,000 units	810 units
B	400 units	475 units	360 units
C	1,450 units	1,600 units	1,350 units
D	775 units	925 units	its

The purchases and issues of material X in the month of January 2015, is as follows:

Jan.	3 Purchase	800 units @ ₹ 20 per unit
Jan.	8 Purchase	700 units @ ₹ 18 per unit
Jan.	9 Issue	600 units
Jan.	11 Issue	800 units
Jan.	17 Purchase	800 units @ ₹ 20 per unit
Jan.	25 Purchase	500 units @ ₹ 25 per unit
Jan.	31 Issue	1000 units

The standard price per unit of material is ₹ 20 fixed for the year 2015. Show the Stores Ledger entries and determine the price variance for the month of January.

(Ans: Value of Stock on January 31, 2015 ₹ 9,100; Price Variance ₹ 1,100 Un-favourable)

20. XYZ company buys in lots of 500 boxes which is a 3 month supply. The cost per box is ₹125 and the ordering cost is ₹150. The inventory carrying cost is estimated at 20% of unit value.

What is the total annual cost of the existing inventory policy?

How much money could be saved by employing the economic order quantity? (Ans: Saving by adopting EOQ = ₹ 2,977)



21. Following information in an inventory problem is available:

Annual demand	8,400 units
Unit price (₹)	2.4
Ordering cost (₹)	4.0
Storage cost (₹)	2%
Interest rate	10% p.a.
Lead time	1/2 month

Calculate EOQ, Reorder level and total annual inventory cost. How much does the total inventory cost vary if the unit price is changed to ₹5 ?

**(Ans: Variation in Inventory Cost = 42,201)**

22. A cast iron foundry is importing forged steel moulds for making its castings. The moulds are of four different sizes A,B,C and D and their CIF values are US \$4,140; 4,160; 6,340, and 7,875 respectively. Customs duty may be assumed at 45% and clearing charges 5% of CIF value. The number of castings that can be made out of each mould is:

A - 1,000 B - 2,000, C - 1,800 and D - 1,500.

The weight of each casting out of A is 300 kg. B - 400 kg. C - 500 kg and D - 700 Kg. The casting suffer a normal rejection of 10%. You are required to calculate the average cost of mould per tonne of saleable casting.

(For conversion assume US \$ 1 = ₹ 8)

**(Ans: Cost per tonne of saleable castings = A = ₹ 184; B = ₹ 69.33; C = ₹ 93.93; D = ₹ 100)**

23. G Ltd. produces a product which has a monthly demand of 4,000 units. The product required a component X which is purchased at ₹ 20. For every finished product, one unit of component is required. The ordering cost is ₹ 120 per order and the holding cost is 10% p.a.

You are required to calculate: Economic order quantity.

If the minimum lot size to be supplied is 4,000 units. What is the extra cost, the company has to incur?

What is the minimum carrying cost, the company has to incur?

**(Ans: Minimum carrying cost = ₹ 2,400)**



**MULTIPLE CHOICE QUESTIONS**

1. Which of the following is considered as normal loss of material?  
A. Pilferage      B. Loss due to accident      C. Loss due to careless handling of material  
D. None of these.
2. The most important element of cost is-  
A. Material      B. Labour      C. Overheads      D. All of these
3. Direct material is a –  
A. Administration Cost    B. Selling and Distribution cost    C. All of these    D. None of these
4. Continuous stock taking is a part of-  
A. ABC analysis    B. Annual stock taking      C. Perpetual Inventory      D. None of these
5. Which of the following is considered as accounting record?  
A. Bin Card      B. Bill of material      C. Store Ledger      D. None of these
6. Direct material can be classified as  
A. Fixed cost      B. Semi-variable cost    C. Variable cost      D. Prime cost  
E. None of the above
7. In most of the industries, the most important element of cost is  
A. Labour      B. Overheads      C. Administration Cost      D. Material  
E. All of the above
8. In which of following methods of pricing, costs lag behind the current economic values?  
A. Replacement price method      B. Last-in-first out price method  
C. First-in-first out price method      D. Weighted average price method  
E. None of the above
9. In which of the following methods, issues of materials are priced at pre-determined rate?  
A. Replacement price method      B. Inflated price method  
C. Specific price method      D. Standard price method  
E. None of the above
10. Which of the following methods smoothes out the effect of fluctuations when material prices fluctuate widely?  
A. FIFO    B. Simple Average    C. LIFO    D. Weighted average    E. None of the above
11. Under the FSN system of inventory control, inventory is classified based on:  
A. Value of items of inventory      B. Criticality of the item of inventory for production  
C. Frequency of items of inventory use    D. Volume of material consumption  
E. None of the above





12. Materials are issued from one process to another, based on:
- A. Bill of Materials                      B. Material Requisition Note              C. Purchase Requisition Note
- D. Material Transfer Note              E. None of the above

[Ans: C, A, D, C, C, C, D, C, D, D, C, D]

**State whether the following statement is True (or) False:**

1. Waste and Scrap of material have small realization value.
2. Slow moving materials have a high turnover ratio.
3. Bin card are not the part of accounting records.
4. ABC analysis is based on the principle of management by exception.
5. Store ledger is maintained inside the stores by store keeper.

[Ans: F, F, T, T, F]

**Fill in the Blanks:**

1. Store Ledger is kept and maintained in \_\_\_\_\_.
2. Goods Received Note is prepared by the \_\_\_\_\_.
3. Transfer of surplus material from one job or work order is recorded in \_\_\_\_\_.
4. \_\_\_\_\_ is discount allowed to the bulk purchaser.
5. \_\_\_\_\_ is a document which records the return of unused materials.

[Ans: Cost Office, Receiving department, Material Transfer Note, Quantity Discount, Material return Note.]

**Match the followings:**

1	Production strategy	A	ABC Analysis
2	Analytical method of stock control	B	JIT
3	Process of classifying Material	C	Control of Scrap
4	Unavoidable residue material	D	Costing department
5	Store ledger	E	FSN Analysis

[Ans: (1) - (B); (2) - (A); (3) - (E); (4) - (C); (5) - (D).]

**2.2 EMPLOYEE COSTS (CAS - 7)**

Labour is an important element of cost and for overall cost control and cost reduction, Labour Cost is of paramount importance. Labour Cost is also called as Employee Cost. However, for control and reduction of Labour Cost, it is essential to compute the Labour Cost in a scientific manner and hence there should be proper systems and processes and documentation, which will help computation of Labour Cost in a scientific manner. It should be remembered that Labour is not like material as there is a human aspect involved in it. Therefore, there should be a comprehensive study of all related aspects of Labour Cost and then only computation and control over the same will be possible. Attention should also be paid to the productivity aspect. Low productivity results in higher Labour Cost per unit while higher productivity will reduce the Labour Cost per unit. All these aspects of Labour Cost are discussed in detail in this chapter. Study of Labour or Employee Cost can better be explained as follows:

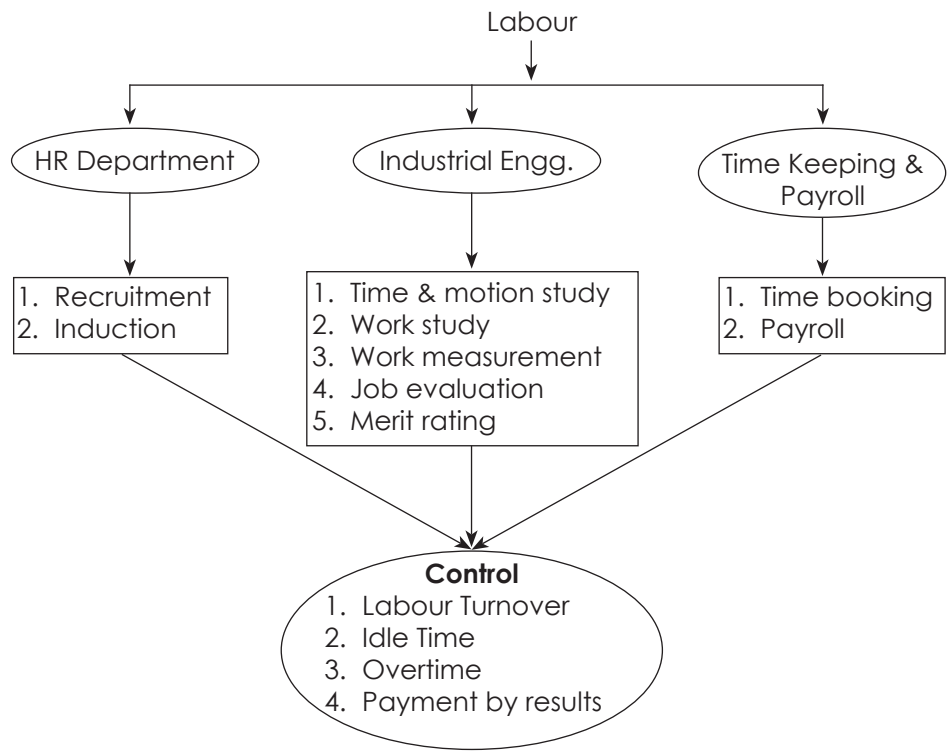

As per CAS-7, (limited Revision - 2017) Employee cost is the benefits paid or payable in all forms of consideration given for the service rendered by employee (including temporary, part time and contract employee) of an entity.

**Various aspects of Labour Cost Control**

In the modern competitive environment, it is essential to make efforts for controlling and reducing the Labour Cost. Systematic efforts are required in order to achieve this target. The following steps will be useful in controlling and reducing the Labour Cost.

**A. Classification of Labour cost**

The first step in the direction of controlling and reducing the Labour Cost is proper classification of the same. The Labour Cost is classified into Direct Cost and Indirect Cost. Direct Labour Cost is the cost that



can be identified with a product unit. It can also be described as cost of all Labour incurred for altering the construction, composition or condition of the product. Indirect Labour Cost is the cost, which cannot be identified with a product unit. It represents the amount of wages which is paid to the workers who are not directly engaged on the production but it includes wages paid to the workers and assistants working in departments like purchasing, store keeping, time office, maintenance, and other service and production departments. In other words, indirect wages are the wages paid to the workers who facilitate the production rather than actually engaged in production. The Direct Labour Cost can be charged directly to the job or product units and is included in the prime cost. Indirect Labour Cost is included in the overhead cost. Direct Labour Cost is variable in nature and can be controlled by strictly adhering to the norms and standards set by the management. Indirect Labour Cost can be controlled by establishing Labour budgets and comparing the actual Indirect Labour Cost with the budgeted Labour Cost. Any difference between the two is analysed carefully and suitable corrective action is taken.

### **B. Production Planning**

Effective control over the Labour Cost Can be achieved through proper production planning. Production planning includes activities like planning, scheduling, routing, machine loading, product and process engineering, work study etc. With the help of work study, time and motion study can be conducted which will help in fixation of standard time for a particular job. A comparison between the standard time and actual time is constantly made to find out the difference between the two. Suitable corrective action can be taken if it is noted that the actual time taken is constantly more than the standard time allowed for the job.

### **C. Labour Budget**

Budget and budgetary control are effective tools for cost control and cost reduction. A Labour budget can be prepared which will set the target for the Labour Cost which will again facilitate comparison between the Budgeted Labour Cost and the Actual Labour Cost.

### **D. Labour Standards**

Standards can be set for Labour Cost against which the Actual Labour Cost can be compared. Standard Labour Cost is the cost, which should have been incurred for producing a particular quantity of production. While fixing the Standard Labour Cost, use of time and motion study is made to fix up the standard time that should be taken for the actual production.

### **E. Labour Performance Report**

There should be a system of periodic Labour efficiency and utilisation reports. These reports will give an idea about the efficiency and productivity of the Labour.

### **F. Incentive Schemes**

Improving the Labour productivity is one of the important ways to reduce the Labour Cost per unit. Productivity can be improved by motivating the workers. Offering monetary and non monetary incentives can help to improve the productivity substantially. However, there should be a periodic review of the incentive schemes and therefore incentive schemes report should be prepared at periodic intervals.

### **G. Labour Cost Accounting**

There should be a proper cost accounting system, which will identify the Direct and Indirect Labour Cost. Similarly the cost accounting department should be able to generate and maintain records for time keeping, time booking, idle and overtime, impact of incentive schemes, per unit of Labour, cost due to Labour Turnover and other relevant records.

Thus from the above mentioned points, it will be clear that there is a need to control the Labour Cost and it can be done by the combined efforts of various departments.



### Principles of measurement of Employee (CAS-7)

The guide lines for ascertaining the Labour Cost / Employee Cost are as follows:-

- (a) Employee Cost shall be ascertained taking into account the gross pay including all allowances payable along with the cost to the employer of all the benefits.
- (b) Bonus whether payable as a statutory minimum or on a sharing of surplus shall be treated as part of Employee Cost. Ex-gratia payable in lieu of or in addition to bonus shall also be treated as part of the Employee Cost.
- (c) Remuneration payable to managerial personnel including executive directors on board and other officers of a corporate body under a statute will be considered as part of the Employee Cost of the year under reference, whether the whole or part of the remuneration is considered as a percentage of profits.

Explanation: Remuneration paid to non executive directors shall not form part of employee cost but shall form part of administrative overhead.

- (d) Separation costs related to voluntary retirement, retrenchment, termination...etc shall be amortized over the period of benefitting from such costs.
- (e) Employee Cost shall not be included any Imputed Costs.
- (f) Any subsidy, grant, incentive or any such received or receivable with respect to any employee cost shall be reduced from ascertainment of Cost of the cost project to which such amounts are related.
- (g) Any abnormal cost where it is material and quantifiable shall not form part of the Employee Cost.
- (h) Penalties, damages paid to statutory authorities or other third parties shall not form part of the Employee Cost.
- (i) The cost of free housing, free conveyance and any other similar benefits provided to an employee shall be determined at the total cost of all resources consumed in providing such benefits.
- (j) Any recovery from employees towards the facilities provided shall be reduced from the Employee Cost.
- (k) Cost of idle time is ascertained by the idle hours multiplied by the hourly rate applicable to idle employee or a group of employee.
- (l) Where Employee Cost is accounted at standard cost, variances due to normal reasons related to employee cost shall be treated as part of Employee Cost. Variances due to abnormal reasons shall be treated as part of abnormal cost.
- (m) Any change in the cost accounting principles applied for the determination of the Employee Cost should be made only if it is required by law or for compliance with Cost Accounting Standard or change would result in a more appropriate way of presentation of Cost Statement.

### Control of Labour Cost

Labour cost consists of the total amount of wages paid to the workers and other expenses related thereto. It includes hourly or piece-rates payable to the workers. It may be excessive due to inefficiency of labour force, high idle time and overtime payments, increase in spoilage, waste and defective production due to lack of supervision and inspection, high labour turnover and other matters. Therefore it is clearly seen that the control of labour cost is essential in every organization to cut down the cost of production and to improve the labour productivity/efficiency. The following departments play a vital role in Labour Cost Control:-

#### (a) Human Resources Department

This department is responsible for the execution of policies regarding appointment, discharge, transfer, promotion, classification of labour, wage and incentive systems, etc, which have been formulated by



the board of directors or executive committee. It normally maintain detailed records of attendance, leave records, overtime and shift records from which various calculations of wages, allowances, overtime, incentives are made. Reports concerning labour turnover, recruitment, productivity, utilization, absenteeism as well as reports on labour cost, idle time, various cost ratios etc., are prepared here for submission to higher authorities for necessary action.

#### **(b) Engineering, Industrial Engineering Department**

This department helps to maintain control over working conditions, production methods, job performances by preparing plans and specification for each job scheduled for production, maintaining safety and efficient working conditions, initiating and supervising research and development activities, making method study, motion study, and time study, setting piece-rates, making job evaluation, merit rating and job analysis, measuring labour productivity and in general suggesting ways and means to improve labour efficiency/productivity thereby cutting down the effective labour cost.

#### **(c) Time Keeping Department**

The function of this department is mainly to keep, maintain the time for which each and every worker has worked including the check-in and check-out time. The records are kept separately for different shift and irregular working periods like overtime period. The records are such kept that the departments wise/product wise/process wise/ batch wise/job wise/operation wise allocation of labour cost is possible. The entire correctness of calculation of payroll, overtime payments, incentive payments, overhead allocation depend on the records maintained by this department and as such the importance of the functions rendered by this department cannot be over emphasised.

#### **(d) Payroll Department**

This departments is responsible for preparation of payroll and also basically to maintain records of job classification, department wage rates to prepare each man's earnings, to allocate those earnings to various cost centres to summarise various deductions and employers' share of provident fund, state insurance and other items, and also to summarise overtime payments and incentive payments wherever applicable.

#### **(e) Cost-Accounting Department**

This department is responsible for the accumulation and compilation of all cost data relating to the element Labour. It analyses the payroll cost to effectively render routine and special labour, cost reports thereby disclosing the amount of normal, and abnormal idle time, direct labour, indirect labour, overtime and departmental labour costs and variances between actual and standard labour costs. These reports are used by the top management to effectively control the labour cost and also to improve the labour productivity/efficiency.

#### **Important factors for the control of Employee Cost**

The factors which need consideration for the purpose of controlling employee cost effectively are as follows:

- (a) Assessment of manpower requirements
- (b) Control over time-keeping and time-booking
- (c) Time & Motion Study
- (d) Control over idle time and overtime
- (e) Control over employee turnover
- (f) Wage and Incentive systems
- (g) Job Evaluation and Merit Rating
- (h) Employee productivity



### Collection of Employee Cost

It is the responsibility of the Cost Accounting Department to ascertain the effective wages per hour in each department and analyse the total payment of wages of each department into:

- (a) the amount included in the direct cost of goods produced or jobs completed
- (b) the amount treated as indirect employee and thus included in overheads
- (c) the amount treated as the cost of idle time
- (d) the amount treated as abnormal loss/gain and to be transferred to profit and loss account

In this process the costs of various jobs are ascertained and the proper recording of time spent by the employees can be ensured.

### Time Keeping

Like Personnel Department, this department also plays an important role in labour cost control through maintaining record of each worker's time in and time out during regular working period and reporting the time of each worker for each department, operation or production order. Thus this department is responsible for recording the attendance time of each worker accurately. This will ensure punctuality and discipline in the company and will have a positive impact on the morale of each worker. Time keeping is a statutory requirement also and therefore accurate recording of time should be ensured. The important role of time keeping from the point of view of labour costing and control can be summarized as given below:

- (a) It shows the total number of hours worked by each workman and so the calculation of his wage becomes possible. This is applicable where the workers are paid wages as per the time rate.
- (b) Time keeping promotes punctuality and discipline amongst the workers. In the absence of the time keeping system, there will be not only indiscipline amongst them but the workers who are otherwise punctual and disciplined will be frustrated.
- (c) Certain benefits like pension, gratuity and leave with pay, provident fund, promotion, and salary scale are linked with the continuity of service. Attendance records in this regard, can be helpful in computation of these benefits.
- (d) Computation of Labour hours becomes possible through time keeping records. This will be useful in overhead apportionment and absorption, which may be made on the basis of Labour hours.
- (e) Time keeping is a statutory requirement under Labour laws.
- (f) The time keeping records can be used for further analysis like for fixation of standard time and finding out idle time as well as the efficiency of Labour. It can be used by researchers as well as by Government Authorities for various purposes.

### Methods of Time Keeping

The above-mentioned points highlight the importance of the time keeping. The question that we have to answer now is that what are the methods of time keeping? The answer to this is given in the following paragraphs. The methods of time keeping are explained below:

- (1) Attendance Records:** This is the simplest and the oldest method of marking attendance of workers. In this method, every worker signs in an attendance register against his name. Leaves taken by workers as well as late reporting is marked on the attendance register itself. The main limitation of this system is that in case there is large number of workers, there may be large queues for signing the muster. Similarly there is little control over marking the attendance time and hence there may be irregularities in time recording.



- (2) **Disc Method:** This is one of the older methods of recording time. A disc, which bears the identification number of each worker, is given to each one. When the worker comes in, he picks up his disc from the tray kept near the gate of the factory and drops in the box or hooks it on a board against his number. Same procedure is followed at the time of leaving the factory. The box is removed at starting time, and the time keeper becomes aware of late arrivals by requiring the workers concerned to report him before starting. The time keeper will record in an Attendance Register any late arrivals and workers leaving early. He will also enter about the absentees in the register on daily basis. The main limitation of this method is that there is a possibility of marking the attendance of a worker by his friend i.e. by a proxy. Secondly if the number of workers is large, there will be a delay in recording time due to manual operation of this system.
- (3) **Time Recording Clocks or Clock Cards:** This is mechanized method of time recording. Each worker punches the card given to him when he comes in and goes out. The time and date is automatically recorded in the card. Each week a new card is prepared and given to the worker so that weekly calculation of wages will be possible. If wages are paid on monthly basis, a new card may be given in each month. Due to advancement of technology, giving a new card each month is also not required as the same card continued till the worker either leaves the service or retires from the service. The only limitation of this method, [in fact it is the limitation of all the methods of time keeping] is that though the time in and time out are recorded, the records do not show the productive time of the worker, i.e. how he has spent the time in the factory. Thus if a worker comes in at 8 am and leaves at 5 pm, he has spent 9 hours in the company, which can be ascertained from the time keeping records. However, how he has spent time, is not shown by these records. For showing the productive time, separate records showing time booking are to be prepared. The time booking records can also be combined with time keeping records so that there is no need to keep dual records.
- (4) **Bio-metric Attendance System:** According to Bio-metric attendance system, attendance of the employees is marked by recognising an employee based on physical and behavioural traits. An employee's unique identity like finger print, face and retina image etc. are kept in a database which is matched at the time of marking of attendance before the attendance device for this purpose. Bio-metric attendance system includes finger print recognition system, face recognition system, Time and attendance tracking technology etc. This system reduces the risk of time manipulation and proxy attendance. However, it may not be possible for small organisations due to cost associated with set-up and maintenance of this system.

### Essentials of a Good Time Keeping System

A good time keeping system is supposed to have the following requirements.

- (i) System of time-keeping should be such as not to allow proxy for another employee under any circumstances.
- (ii) There should be a provision of recording of time of piece employees so that regular attendance and discipline can be maintained.
- (iii) Time of arrival as well as time of departure of employees should be recorded so that total time of employees can be recorded and wages can be calculated accordingly.
- (iv) Method of recording of time should be mechanical as far as possible so that chances of disputes regarding time may not arise between employees and the time-keeper.
- (v) Late-comers should record late arrivals. The time-keeper should adhere to this discipline strictly.



- (vi) The system should be simple, smooth and quick. Unnecessary queuing for marking attendance should be avoided.
- (vii) The system should be reviewed periodically to prevent any error or loophole.

### Time Booking

In time keeping we have seen that the basic objective of time keeping is to mark the attendance time, i.e. time in and time out. Time keeping aims at keeping a check on the number of hours spent by a worker in the factory. However, it does not record the productive time of the workers. It means the time keeping methods do not provide information about how the time is spent by the workers in the factory. For example, the time keeping record will show that the worker has reported for duty at 8 am and left at 6 pm, thus, he has spent 10 hours in the company. But the analysis of these 10 hours is not provided by the time keeping. In view of this there is a need to have a system, which will tell about the productive time spent by the workers in the factory. The method, which supplies this information, is known as 'Time Booking Methods' and the recording the time spent by a worker in each job, process or operation is known as 'Time Booking'. The objects of time booking are as follows:-

- (i) To determine the productive time spent by the worker on the job or operation. This helps in finding out the idle time and controls the same
- (ii) To determine the quantity and value of work done
- (iii) To determine earnings like wages and bonus
- (iv) To determine the efficiency of workers

### Time Booking Methods

The following methods are used for time booking:-

- (1) Daily Time Sheet:** In this method, each worker records the time spent by him on the work during the day, for which a sheet is provided to each worker. The time is recorded daily and hence accuracy is maintained. However, the main limitation of this method is lot of paper work is involved as daily sheets are maintained on daily basis by each worker.
- (2) Weekly Time Sheets:** The only difference between the daily time sheet and weekly time sheet is that these time sheets are maintained on weekly basis. This means that each worker prepares these sheets weekly rather than daily. This helps in reducing the paper work to a great extent.  
The only care to be taken is that since the information is filled up on daily basis, there may be inaccuracies and hence filling the information should be done on daily basis only.
- (3) Job Ticket:** Job tickets are given to all workers where time for commencing the job is recorded as well as the time when the job is completed. The job tickets are given for each job and the recording of the time as mentioned above helps to ascertain the time taken for each job. After completing one job, the worker is given another job.
- (4) Labour Cost Card:** This card is meant for a job, which involves several operations or stages of completion. Instead of giving one card to each worker, only one card is passed on to all workers and time taken on the job is recorded by each one of them. This card shows the aggregate labour cost of the job or the product.
- (5) Time and Job Card:** This card is a combined record, which shows both, the time taken for completion of the job as well as the attendance time. Therefore there is no need to keep separate record of both, time taken and attendance time.

Thus we may distinguish time keeping and time booking, that the time keeping is simply maintaining attendance of the workers i.e the time of arrival and the time of departure and there by the time spent by the worker in the organization is measured, where as time booking is not only maintaining the time spent by the workers in the organization, but also the time spent on each & every job including the idle time with reasons are recorded.





### Work Study

In order to motivate workers, it is necessary to design a proper incentive system of payment of wages. Money is the strongest motivating factor and hence monetary incentive system become essential. In any incentive system, the bonus is paid by comparing the standard performance/production with the actual performance, i.e. actual production. Bonus is paid if the actual performance is higher than the standard one. However, for deciding the standard performance, standard time, i.e. time that is allowed doing a particular job should be fixed against which the actual time taken should be compared. The Work Study which includes, the Job Study, and the Method Study ensures the fixation of standard time to do a particular job and thus has become extremely important in the designing of the incentive system. Work Study components are discussed below.

### Method Study

Method Study is done to improve the methods of production and to achieve the most efficient use of the resources like, manpower, machines and materials. Method Study has the following stages:-

- (a) Method Study is generally conducted for the jobs, which involve complex operations as well as costly operations. Hence the first step is to select jobs, which are having complexity of operations.
- (b) There should be a detailed study of related aspect of the selected job. Information about the job like, purpose, location, sequence, relationship with other work, methods of working, operators, requirement of skilled workers, facilities required etc. should be collected.
- (c) The crucial step is that after studying the relevant aspects of the job, there should be development of the improved method of doing the job. An improved method of job might change the location and sequence of the work, methods of production and the layout for the job. The improved method will result in more efficiency, more simplicity and effectiveness and job will be done in a better manner.
- (d) The developed method should be applied in doing the job.
- (e) For any new method, a follow up is always required. For method study also a constant follow up is necessary to ensure that the method selected is implemented properly. Thus method study ensures efficient use of resources by reducing unnecessary work and helps to achieve highest production.

### Work Measurement

The Work Measurement aims at determining the effective time required to perform a job. The ineffective, wasteful or avoidable time is separated from required time to complete the work. The effective time so established in work measurement can be used for the following purposes:-

- (a) Incentive wage schemes which require data about the time allowed and time taken for a particular job
- (b) Improving utilization of men, machines and materials
- (c) Assisting in production control
- (d) Assisting in setting labour standards
- (e) Cost control and reduction

The following stages are involved in work measurement:-

- (i) Selection of work
- (ii) Measuring the actual time taken in the work done
- (iii) Making comparison between the standard time and the actual time



## Job Evaluation

It is necessary for the management of any organization to establish proper wage and salary structure for various jobs. For doing this in a scientific manner, it is necessary to determine the relative value of jobs and hence a job evaluation is done. Job Evaluation is a technique of analysis and assessment of jobs to determine their relative value within the firm. It aims at providing a rational and equitable basis for differential salaries and wages for different classes of workers. Job Evaluation has the following objectives:-

- (a) It helps in developing a systematic and rational wage structure as well as job structure.
- (b) Job Evaluation aims at removing the controversies and disputes relating to salary between the employers and employees. Thus the employees and also the employer remain satisfied.
- (c) Another important objective of Job Evaluation is to bring fairness and stability in the wage and salary structure so as to ensure full cooperation of workers in implementing various policies of the employers.
- (d) Job Evaluation discloses characteristics and conditions relating to different jobs. This is very useful at the time of recruiting of workers as only suitable workers can be recruited. This avoids square pegs in round holes.

## Methods of Job Evaluation

Methods of job evaluation are as follows:-

**(1) Point Ranking Method:** In this method each job is analyzed in terms of various job factors or characteristics. The characteristics are skills required, efforts involved, working conditions, hazards, responsibility and so on. In other words the job factors are the requirements needed for performing the job effectively. Each job factor is given weightage or points depending upon its value for the job. For example, for certain jobs, maximum value is assigned to experience while for some jobs, education may be the most crucial factor. Finally each job is ranked in the order of points or weights secured by them. The wage structure can be suitably designed according to the points assigned to each job. The method is quite sound in principle but difficulties may be faced assigning the weights to each job.

**(2) Ranking Method:** In this method, jobs are ranked in order of importance on the basis of skills required, experience requirements, working conditions etc. Jobs are rearranged in an order, which can be either from the lowest to the highest or in the reverse. Wage scales are determined in terms of ranks. Though this method is quite simple to operate and less costly as well as easy for understanding, it is suitable when the size of the organization is small and jobs are few and well defined. In a large organization, where jobs are quite complex, this method is not beneficial.

**(3) Grading Method:** This method is an improvement over the ranking method. Under this method, each job is analyzed in terms of a predetermined grade and then assigned a grade or class. Grades are established after making an investigation of job factors, such as complexity in the job, supervision, responsibility, education etc.

## Merit Rating

Job Evaluation is the rating of the job in order to bring rationality in the wage and salary structure in the organization. On the other hand Merit Rating is the comparative evaluation and analysis of individual merits of the employees. The Merit Rating aims at evaluation and ranking the individual employees in order to plan and implement rational promotional policies in the organization. Merit Rating has the following objectives:-

- (a) To evaluate the merit of an employee for the purpose of promotion, increment, reward and other benefits
- (b) To establish and develop a wage system and incentive scheme
- (c) To determine the suitability of an employee for a particular job



- (d) To analyze the merits or limitations of a worker and help him to develop his capability and competence for a job
- (e) To examine characteristics like cooperation, quality of work done, attendance and regularity, education, skill, experience, character and integrity and initiative

Thus it can be understood that Merit Rating is extremely useful for organizations for evaluating the employees. However the main limitations are that the rating can be subjective which will give rise to the disputes and there is a possibility that past performance of an employee may be given too much importance.

### **Difference between Merit Rating and Job Evaluation**

The difference between the Merit Rating and Job Evaluation are as follows:-

- (a) Job Evaluation is the assessment of the relative worth of jobs within a business enterprise and Merit Rating is the assessment of the employees with respect to a job.
- (b) Job Evaluation helps in establishing a rational wage and salary structure. On the other hand, Merit Rating helps in fixing fair wages for each worker in terms of his competence and performance.
- (c) Job Evaluation brings uniformity in wages and salaries while Merit Rating aims at providing a fair rate of pay for different workers on the basis of their performance.

### **Time and Motion Study**

The study of time and motion is essential for designing an incentive system. Time Study determines the time to be spent on the job. Standard time is the time that should be taken for completing a particular job under standard or normal working conditions. For fixation of standard time, Motion Study is necessary. Thus, the Motion Study precedes the Time Study. Motion Study means dividing the job into fundamental elements or basic operations of the job or process and studying them in detail to eliminate the unnecessary elements or motions. After investigation all movements in a job, process or operation, the Motion Study aims at finding out the most scientific and systematic way of performing the job. After eliminating unnecessary motions, the time that should be taken to perform these motions is decided with the help of a stop-watch. In the time so fixed, some allowance is added in the same for normal idle time, which is due to fatigue, change of job, change of tools, and preventive maintenance of machines and so on. Thus standard time for a job or process is arrived at. The Time and Motion Study aims at:-

- (a) Eliminating unnecessary motions, thereby reducing inefficiency
- (b) Improving methods, procedures, techniques, and processes relating to a job
- (c) Effective utilization of men, material, machines and time
- (d) Improving working environment, layout and design of plant and equipment

The following are the *benefits* of Time and Motion Study:-

- (a) Effective utilization of resources like men, material, machine and time
- (b) Helps in assessment of labour
- (c) Helps in designing incentive system as many of the incentive systems are based on standard time
- (d) Preparation of labour budget
- (e) Proper planning of production for preparation of production budget
- (f) Helps in improving labour productivity by designing best method for performing a job or process
- (g) Improvement of work methods



### Payroll Department

Roll of Payroll Department is of crucial importance in overall Labour Cost computation and control. The main responsibilities of this department are preparation of payroll from clock cards, job or time tickets, or time sheet. The payroll shows the amount of wages payable to each worker showing the gross wages payable, the deductions and the net wages payable. For doing this calculation, they have to work in collaboration with the time office, personnel department, Cost Accounting department and with the concerned department in which the worker is working. The functions of this department are given below:-

- (a) To compute the wages of the employees
- (b) To prepare a detailed wages sheet showing the gross wages payable, various deductions and other payroll liabilities
- (c) To maintain individual employee payroll records
- (d) To prepare department wise summaries of wages
- (e) Compilation of Labour statistics for management
- (f) To install and implement an effective internal check system for preventing frauds and irregularities in payment of wages
- (g) To detect and prevent ghost workers

### Cost Accounting Department

The Cost Accounting department is responsible for analyzing the Labour Cost for the purpose of computation and control of the same. It is responsible for the accumulation and classification of all cost data of which Labour Cost is one of the important components. The Cost Accounting department classifies the Labour Cost into direct and indirect, compares the actual Labour Cost with the budgeted cost, compute unit Labour Cost and compiles the data for further analysis of the Labour Cost. The data generated can be useful for the management in taking decisions.

### Payroll Procedure

Following activities and the responsibility to discharge such activities are mentioned hereunder:

Activity	Responsibility
(i) Attendance and time details	(i) Time-keeping department
(ii) Preparation of list of employees and other details	(ii) Personnel/HR department
(iii) Computation of wages and other incentives	(iii) Payroll department
(iv) Payment to employees	(iv) Cost/Accounting department
(v) Discharge of statutory liabilities	(v) Cost/Accounting department

### Overtime Wages / Overtime Premium

The Factories Act provides for payment of overtime wages at double usual rates of wages. Even where the Act is not applicable, the practice is to pay for overtime work at higher rates usually in accordance with a standing agreement between the employer and the workers. Hence, payment of overtime consists of two elements, viz., the normal (i.e., usual) amount and the extra payment, i.e., the premium. As per CAS-7, the overtime. Overtime premium is defined as 'Overtime is the time spent beyond the normal working hours which is usually paid at a higher rate than the normal time rate. The extra amount payable beyond the normal wages & salaries for beyond the normal working hours is called Overtime Premium'.



### Treatment of Overtime in Cost Records

As per CAS-7 (Limited Revision 2017), Overtime Premium shall be assigned directly to the cost object or treated as overheads depending on the economic feasibility and specific circumstances requiring such overtime.

When overtime is worked due to exigencies or urgencies of the work, the basic / normal payment is treated as Direct Labour Cost and charged to Production or cost unit on which the worker is employed. Whereas the amount of premium (extra amount) is treated as overhead.

If overtime is spent at the request of the customer, then the entire amount (including overtime premium) is treated as direct wages and should be charged to the job.

When the overtime is worked due to lack of capacity as general policy of the company, then the total amount paid is treated as direct wages which is computed at the estimated rate based on the figures of the previous years.

Overtime worked on account of the abnormal conditions such as flood, earthquake, etc., should not be charged to cost, but to costing Profit and Loss Account if integrated accounts are maintained.

It will thus be seen that overtime involves payment of increased wages and should be resorted to only when extremely essential. The disadvantages attached to overtime working are as follows :

- (a) It involves excess labour cost.
- (b) There is decrease in productivity. Output is usually proportionate to the excess time worked as efficiency during late hours is diminished.
- (c) Work in the evenings increases lighting cost.
- (d) Continuous work for long periods leads to fatigue and defective work.
- (e) It falls upon the health of the workers.
- (f) Overtime work if not properly distributed among the workers may lead to discontentment.
- (g) There is an unusual strain on plant and machinery.
- (h) Once overtime is resorted to for some time, the workers take the overtime wages as part of their normal earnings and resist future attempts to discontinue overtime work.
- (i) There is a tendency to keep the work pending to be done during overtime period or to intentionally slow down in order to compel the management to sanction overtime.

It may, however, be said in favour of overtime work that it increases the productive capacity of the concern as more work is done with the existing resources. Overtime work is particularly useful in pulling up backlog in production arising due to shutdown, breakdown, power failure and such other contingencies.

Though overtime work cannot be completely eliminated, it is essential that proper control should be exercised to keep it to the minimum. The following steps should be taken to control the Overtime:

- (a) All overtime work should be duly authorised after investigating the necessity thereof.
- (b) Overtime cost should be recorded separately and shown against the department incurring it. This will enable proper investigation and planning of production in future.
- (c) If overtime tends to be a permanent feature, the necessity of recruiting more men and shifting working should be considered.
- (d) If overtime is due to lack of plant or machinery or other resources, steps may be taken to install more machines, or to give subcontracts alternatively, to restrict production so as to complete it within the normal time.



### Idle Time

Idle Time Cost represents the wages paid for the time lost during which the worker does not work, i.e. time for which wages are paid, but no work is done. As per CAS-7 (Limited Revision 2017), Idle Time is 'The difference between the time for which the employees are paid/payable to employees and the employees time booked against the cost object'. This happens because due to various causes for which he is not responsible, the worker remains idle but full wages are paid to him. Even for workers who are paid on the basis of output, idle time payment may be required to be made.

The causes leading to idle time may be broadly classified into four categories, viz.:-

- (i) *Normal, inherent or unavoidable idle time*: Time lost between the gate and place of work, break for tea, time interval between one job and another, time for tool setting, adjustment of machine, etc.
- (ii) *Normal idle time* such as waits for jobs, tools, materials or instructions, small power failures, small breakdown of machines and tools, and atmospheric conditions
- (iii) *Abnormal idle time* such as those arising due to breakdown for considerable period, non-availability of raw materials, slack supervision, strikes or lock-outs, fire flood, storm, etc.
- (iv) *Concealed idle time* such as manipulation of job breaking, wastage of time due to under-employment, i.e., unnecessary work like cleaning, grass cutting and gardening to employ idle men, and employment of skilled workers on unskilled jobs

Idle time should not be booked directly to jobs or production orders because such a practice not only increases the cost of direct labour, but also vitiates comparison of idle time costs from time to time. In booking of time, idle or waiting time should not normally record in the job card but on separate idle time cards. Separate cards or registers may be provided for recording idle time according to the causes which give rise to it.

### Treatment of Idle Time

As per CAS-7 (Limited Revision 2017), Idle Time Cost shall be assigned direct to the cost object or treated as overheads depending on the economic feasibility and specific circumstances causing such idle time.

Treatment of different categories of Idle Time are as below:-

- (a) Unavoidable idle time above would be for insignificant periods. In Cost Accounts, this is allowed to remain merged in the Production Order or Standing Order Number on which the worker was otherwise employed.
- (b) Normal Idle Time is booked to factory or works overhead. For the purpose of effective control, each type of idle time, i.e., idle time classified according to the causes is allocated to a separate Standing Order Number.
- (c) Abnormal Idle Time would usually be heavy in amount involves longer periods and would mostly be beyond the control of the management. Payment for such idle time is not included in cost and is adjusted through the Costing Profit and Loss Account or included in Profit and Loss Account, when the accounts are integrated.
- (d) Tendency to conceal Idle Time should be discouraged. It is a non-effective time and the resultant loss of profit due to reduced production activity but also increases the cost per unit of production as the fixed costs continue to be incurred, irrespective of the reduced quantum of production due to loss of labour time. Idle Time should, therefore, be highlighted prominently so that action can be taken to remove the causes thereof. Although for obvious reasons, it is not possible to record minor details, vigilance is necessary for finding out long-term idleness among the workers.



### Idle Time Preventive Measures

Idle Time may be eliminated or reduced to a large extent by taking suitable preventive measures such as (a) proper planning of production in advance, thus reducing imbalances in production facilities, (b) timely provisioning of materials, (c) regular maintenance of machines so as to avoid breakdown, and (d) careful watch over the labour utilization statement. The remedial measure to be taken will, no doubt, depend upon the particular factor or situation which caused the Idle Time.

### General principles in designing the system of remuneration to Employee

Remuneration is the reward for labour under normal circumstances and is generally based on either time spent or on the result produced. The former is called "time-related" remuneration and the latter is known as "Piece-related" remuneration. The fixation of method of remuneration in a proper manner is vitally important for any organisation because it deals with the most sensitive item of the input, i.e., Labour.

The general principles which should be considered in designing a proper method of labour remuneration is summarized below:-

- (a) The basis should be simple to understand and the various segments of the system, should clearly mention in detail.
- (b) The employees should be able to accept the method without any doubts or hesitation in their mind.
- (c) The method should be flexible enough to adopt any changes or variation which may become inevitable at a later stage.
- (d) The method should be able to cut down/stabilize the labour turnover which is often causes due to unsatisfactory or unacceptable method of remuneration.
- (e) The method should assure fair wages to the employees so that both the employers and the employees can gain by such methods, the former by way of higher productivity and the latter by way of higher earnings.
- (f) Incentive payments should be a part of the method of remuneration with a view to increase the labour productivity.
- (g) The method should be able to minimise the level of absentees so that avoidable wastages in labour cost can be reduced.
- (h) The method should ultimately result into higher production and improved quality of the output.

### Methods of Wage Payment

One of the important components of Labour Cost Control is the wages system. A system of wage payment, which takes care of both, i.e. providing guarantee of minimum wages as well as offering incentive to efficient workers helps to motivate the workers to a great extent. It should also be remembered that high wages do not necessarily mean high labour cost because it may be observed that due to high wages the productivity of workers is also high and hence the per unit cost of production is actually decreased. On the other hand, if low wages are paid, it may result in lower productivity and hence higher wages do not necessarily mean high cost.

The following are the various methods of payment of wages.

#### A. Time Rate System

- (a) At ordinary levels
- (b) At high wage levels and
- (c) Graduated Time Rate

#### B. Piece Rate

- (a) Straight Piece Rate



- (b) Piece Rate with Guaranteed Day Rates and
- (c) Differential Piece Rates

**C. Bonus Systems**

- (a) Individual Bonus for Direct Workers
- (b) Group Bonus for Direct Workers and
- (c) Bonus for Indirect Workers

**D. Indirect Monetary Incentives**

- (a) Profit Sharing and
- (b) Co-partnerships

**E. Non monetary incentives like job security, social and general welfare, sports, medical facilities etc.**

These methods are discussed in the following paragraphs:-

**A. Time Rate Method**

**Time Rate at Ordinary Levels**

Under this method, rate of payment of wages per hour is fixed and payment is made accordingly on the basis of time worked irrespective of the output produced. However, overtime is paid as per the statutory provisions. The main benefit of this method for the workers is that they get guarantee of minimum income irrespective of the output produced by them. If a worker is not able to work due to genuine reasons like illness or physical disability, he will continue to get the wages on the basis of time taken for a particular job. This method is used in the following situation:-

- (a) Where the work requires high skill and quality is more important than the quantity.
- (b) Where the output/services is not quantifiable, i.e. where the output/services cannot be measured.
- (c) Where the work done by one person is dependent upon other person, in other words where a individual worker has no control over the work.
- (d) Where the speed of production is governed by time in process or speed of a machine.
- (e) Where the workers are learners or inexperienced.
- (f) Where continuous supervision is not possible.

The main advantage of this method is that the worker is assured of minimum income irrespective of the output produced. He can focus on quality as there is no monetary incentive for producing more output. However, the main limitation of this method is that it does not offer any incentive to the efficient workers. Efficient and inefficient workers are paid at the same rate of wages and hence there is a possibility that even an efficient worker may become inefficient due to lack of incentive.

**Time Rate at High Wage Levels**

This system is a variation of time rate at ordinary levels in the sense that in this system, workers are paid at time rate but the rate is much higher than that is normally paid in the industry or area. In this method, the workers are paid according to the time taken and overtime is not normally allowed. This method offers a very strong incentive to workers and it can attract talented workers in the industry. However, care should be taken that productivity also increases; otherwise the cost will go on increasing.

**Graduated Time Rate**

Under this method payment is made at time rate, which varies according to personal qualities of the workers. The rate also changes with the official cost of living index.





Thus this method is suitable for both employer and employees.

### **B. Piece Rate Method**

This method is also called as payment by results where the workers are paid as per the production achieved by them. Thus if a worker produces higher output, he can earn higher wages.

Under the piece rate system of wage payment the workers receive a flat rate of wages either for time worked or for units manufactured.

The **advantages** of such a system are summarised below:-

- (a) As the workers are paid on the basis of the results, i.e., for each unit produced, job performed or number of operations completed, there is a tendency on their part to increase their production so that they may earn more wages.
- (b) The increased production thus achieved results in the reduction of overhead expenses per unit of production even through total overheads may increase. The increase in overheads will be relatively small as compared to the increase in turnover.
- (c) The wages being paid on the basis of production, the management know the labour cost per unit or per job.
- (d) The workers are rewarded for their efficiency because the inefficient workers will not get as much as the efficient workers.
- (e) The workers are very careful in handling their tools and machinery, etc., because on the proper maintenance of these depends their higher efficiency and in turn, their higher wages.
- (f) This method is very simple to operate.

The **Disadvantages** on the other hand are as follows:-

- (a) It is not easy to determine the piece work rate on an equitable basis. When a rate has been fixed and later on it is found to be too high, it is very difficult to reduce it as its reduction will cause dissatisfaction and friction among the workers.
- (b) As the labour cost per unit remains the same, the employees do not gain as a result of increase in productivity except to some extent in the form of reduction in overheads. As such if the overhead expenses per unit are relatively small, the advantage to the employer will not be significant.
- (c) Sometimes quantity may increase at the cost of quality. For the reason, a strict inspection has to be maintained in the form of quality control. This will result into additional expenditure.
- (d) Materials may be used in excessive quantities and may be handled carelessly on account of the workers' efforts to achieve high output.
- (e) This method may cause discontentment amongst those who are slow and those who are paid on time basis.
- (f) The workers may in an attempt to increase production, handle the machines carelessly causing major damage or breakdown.

The following are the variations of this method.

#### **Straight Piece Rate**

In this method, rate per unit is fixed and the worker is paid according to this rate. For example, if the rate per unit is fixed at ₹10, and the output produced is 300 units, the remuneration to the worker will be ₹10 X 300 units = ₹3,000. This method thus offers a very strong incentive to the workers and is particularly suitable where the work is repetitive. The benefits of this method are as follows:-

- (a) The method is simple and provides a very strong incentive to the workers by linking the monetary reward directly to the results.



- (b) Productivity can be increased substantially if the rate of pay includes a really adequate incentive.
- (c) Higher productivity will result in lowering the cost per unit.

However, the main limitation of this method is that if a worker is not able to work efficiently due to reasons beyond his control, he will be penalized in the form of lower wages.

### Differential Piece Rates

Under these methods, the rate per standard hour of production is increased as the output level rises. The increase in rates may be proportionate to the increase in output or proportionately more or less than that as may be decided. In other words, a worker is paid higher wages for higher productivity as an incentive. The rate per unit will be higher in this case as compared to the rate paid to a worker with lower productivity. For deciding the efficiency, comparison is made between the standard production and actual production of the worker. If the actual production is more, the worker qualifies for higher rate of wages. The Differential Piece Rate methods will be useful when the production is of repetitive type, methods of production are standardized and the output can be identified with individual workers. The following are the major systems of differential piece rate system:-

- (i) Taylor (ii) Merrick (iii) Gantt Task and Bonus

### Taylor's Differential Piece Rate System

Taylor is regarded as father of scientific management and he has recommended a system of Differential Piece Rate. According to him, there are only two classes of workers, efficient and inefficient. He suggests that while efficient workers should be encouraged to the maximum possible extent, the inefficient workers should be penalized. In order to do this, he has suggested two rates for the two classes of workers. Thus according to Taylor, if the workers are efficient, they should be paid @ 120% of the normal piece rate and if they are inefficient, they should be paid @ 80% of the normal piece rate. For measuring efficiency, each worker will be given a standard production quantity to be produced in the time allowed and the actual production should be compared with the same. If a worker exceeds the standard, he will be regarded as efficient while if he fails to do so, he will be regarded as inefficient. The positive and negative points of this system are as follows:-

#### Merits:-

- (a) There is a very strong incentive to the workers, which helps to achieve higher productivity.
- (b) Due to the incentive, best workers are attracted to the company.
- (c) This method is quite simple and hence easy to understand.

#### Limitations:

- (a) Slow workers and beginners are penalized severely. Similarly workers get penalized for reasons beyond their control, e.g. medical reasons, accidents etc. Therefore it is said that there is no human element in this system.
- (b) In an anxiety to produce more, quality may be neglected in order to achieve higher quantity of production.

### Illustration 1

From the following particulars, calculate the earnings of workers X and Y and also comment on the labour cost.

Standard time allowed: 20 units per hour

Normal time rate: ₹30 per hour

Differential Rate to be applied:

80% of piece rate when below standard



120% of piece rate at or above standard

In a particular day of 8 hours, X produces 140 units while Y produces 165 units.

**Solution:**

Standard production per day is 20 units × 8 hours = 160 units

Worker 'X' produces 140 units which means he is below standard and will get wages @ 80% of the normal piece rate.

**X's earnings:**

Normal piece rate = ₹30 per hour/20 units = ₹1.5 per unit

80% of the normal piece rate = ₹1.20 per unit

Earnings = ₹1.20 × 140 units = ₹168

Labour cost per unit = ₹168/140 units = ₹1.20

**Y's Earnings:**

Y has produced more than the standard production of 160 units and hence he will get wages @ 120% of normal piece rate. His earnings will be as shown below.

Normal piece rate = ₹30 per hour/20 units = ₹1.50 per unit

120% of normal piece rate = ₹1.80 per unit

Earnings = ₹1.80 × 165 units = ₹297

Labour cost per unit = ₹2.97/165 units = ₹1.80

**Comment:** Labour cost increases from ₹1.20 per unit to ₹1.80 per unit. Taylor's system is resisted on this ground as well as on the ground that it is very harsh on the workers.

**Merrick Differential Piece Rate System**

Merrick's system is modification of Taylor's system and is comparatively less harsh on the workers. The scale of remunerations is as follows:-

**Production Rates of Payment**

Up to 83% of production - Normal piece rate

83% to 100% of production - 110% of ordinary piece rate

Above 100% of production - 120% of ordinary piece rate

As mentioned earlier, this method is less harsh on the workers as compared to Taylor's system. It is particularly useful to beginners and also offers an incentive who have potential of higher productivity.

**Gantt Task Bonus Plan**

In this method, there is a combination of time rate, bonus and piece rate plan. The remuneration is computed as shown below:

Production below standard - Guaranteed time rate

Production at standard - Bonus of 20% [normally] of time rate

Production above standard - High piece rate for the entire output

This method assures minimum wages for even too less efficient workers and hence is a preferred method of payment of wages. It also offers reasonably good incentive to efficient workers. However, the main



limitation is that the method is complicated to understand by the workers and hence may create confusion amongst them.

### Illustration 2

X, Y and Z are three workers working in a manufacturing company and their output during a particular 40 hours week was 96, 111 and 126 units respectively. The guaranteed rate per hour is ₹10 per hour, low piece rate is ₹4 per unit, and high piece rate is ₹6 per unit. High task is 100 units per week. Compute the total earnings and labour cost per unit under Taylor, Merrick and Gantt Task Bonus Plan.

#### Solution:

##### (a) Taylor Plan:

High task is 100 units

Worker X = Actual output is 96 units, which is less than the standard. This means he is inefficient and will get 80% of the normal piece rate i.e. @ ₹4.80 per unit. His wages will be = ₹4.80 × 96 units = ₹460.80.

Worker Y = Actual output is 111 units which is more than the standard. This means he is efficient and will get 120% of the normal piece rate i.e. ₹7.20 per unit. His wages will be = ₹7.20 × 111 units = ₹799.20

Worker Z = Actual output is 126 units, more than the standard. This means his wages will be = ₹7.20 × 126 units = ₹907.20.

##### (b) Merrick Plan:

Worker X = High task is 100 units, actual output is 96, this means that the efficiency level is 96%. As per Merrick Plan, wages of X will be 110% of normal piece rate which is ₹6.60 per unit = ₹6.60 × 96 units = ₹633.6

Worker Y = High task is 100 units, actual output is 111 units, efficiency level is 111%. Y will be entitled for wages @ 120% of normal piece rate i.e. @ ₹7.20 per unit. His wages will be, ₹7.20 × 111 units = ₹799.2

Worker Z = High task is 100 units, actual output is 126 units, efficiency level is 126%. Z will get at higher piece rate @ ₹7.20 per unit. His wages will be ₹7.20 × 126 units = ₹907.2

##### (c) Gantt Task and Bonus Plan:

Worker X = ₹10 × 40 hours = ₹400 [X will get guaranteed time rate as his output is below the high task]

Worker Y = ₹6 × 111 units = ₹666 [High piece rate as output is above standard]

Worker Z = ₹6 × 126 units = ₹756 [High piece rate as output is above standard]

### Emerson's Efficiency System

Under this system minimum time wages are guaranteed. Bonus in addition to minimum day wages is given to the worker beyond a certain efficiency level. A worker who is able to attain efficiency measured by his output which is equal to 2/3<sup>rd</sup> of this standard efficiency or above, is deemed to be an efficient worker who deserves encouragement.

The scheme provides for payment of bonus at various levels of efficiency ranging from 66.67% to 150% in the following manner:

- (i) for a performance below 66.67% efficiency, only time rate wages is paid without any bonus
- (ii) for a performance between 66.67% and 100% efficiency, bonus varies between 0.01% and 20%



- (iii) above 100% efficiency level, bonus of 20% of basic wages + 1% for each 1% increase in efficiency is admissible

Emerson's Efficiency System is superior to other differential piece rate as it encourages the slow worker to do better than before. It does not pre-suppose a high degree of average performance. The wages are guaranteed on time basis.

### Points Scheme–Bedaux System

Under this system the quantum of work that can be performed by a worker is expressed in Bedaux Points or B's. These points represent the standard time expressed in terms of minutes that are necessary to perform a job. The standard numbers of points in terms of minutes are determined after analysing each operation or job in detail. Each such minute consists of the time required to complete a fraction of the operation or the job and also an allowance for rest due to fatigue. The workers who are not able to complete the tasks allotted to them within the standard time are paid only the normal daily rate of wages. Those workers who are able to increase their efficiency rate which is equal to the wages for time saved as indicated by excess of B's earned (i.e. standard time for work done – over actual time) are paid 75% of the time saved.

### Individual Bonus Plans

We have seen earlier that in the time rate system, the workers are paid according to the time taken while in case of piece rate system, the output produced by the worker decides his wages as rate per unit is fixed rather than rate per hour. In the premium bonus plan, the gain arising out of increased productivity is shared by both, the employer and employee.

The bonus to be paid to the workers is computed on the basis of savings in the hours, i.e. the difference between the time allowed and time taken. The time allowed is the standard time, which is fixed by conducting a time and motion study by the work-study engineers. While fixing the standard time, due allowance is given for physical and mental fatigue as well as for normal idle time. The actual time taken is compared with this standard time and bonus is payable to the worker if the time taken is less than the standard time.

The individual bonus schemes commonly used are as follows.

- (a) Halsey Premium Plan
- (b) Halsey-Weir Premium Plan
- (c) Rowan Plan
- (d) Barth Variable Sharing Plan

These methods are discussed below:-

#### (a) Halsey Premium Plan

This plan was introduced by F.A. Halsey, an American engineer. In this plan, bonus is paid on the basis of time saved. Standard time is fixed for a job and if the actual time taken is less than the same, the worker becomes eligible for bonus. However bonus is paid equal to wages of 50% of the time saved. A worker is assured of time wages if he takes longer time than the allowed time. The formula for computing the total wages is as follows.

$$\text{Total Earnings} = H \times R + 50\% [S - H] R$$

Where, H = Hours worked, R = Rate per hour, S = Standard time

#### Illustration 3

Time allowed for a job is 48 hours; a worker takes 40 hours to complete the job. Time rate per hour is ₹15. Compute the total earnings of the worker.

**Solution:**

$$\text{Total Earnings} = H \times R + 50\% [S - H] R$$

$$\text{Total Earnings} = 40 \times ₹15 + 50\% [48 - 40] ₹15$$

$$\text{Total Earnings} = ₹600 + ₹60 = ₹660$$

**(b) Halsey – Weir Plan**

Under this method, there is only one difference as compared to the Halsey Plan and that is instead of 50% bonus for the time saved, it is  $33\frac{1}{3}\%$  of the time saved. Accordingly the formula for this method is modified as follows.

$$\text{Total Earnings} = H \times R + 33\frac{1}{3} [S-H]R$$

H = Hours worked. R = Rate per hour, S = Standard time

**(c) Rowan Plan**

This premium bonus plan was introduced by Mr. James Rowan. It is similar to that of Halsey Plan in respect of time saved, but bonus hours are calculated as the proportion of the time taken which the time saved bears to the time allowed and they are paid for at time rate. The formula for computation of total earnings is as follows:-

$$\text{Total Earnings} = H \times R + [S - H]/S \times H \times R$$

Where H = Hours worked, R = Rate per hour, S = Standard time,

**(d) Barth Variable Sharing Plan:**

In this system, the total earnings are calculated as follows:

$$\text{Total Earnings} = R \times \sqrt{S \times H}$$

H = Hours worked, R = Rate per hour, S = Standard time.

**Group Bonus Plan**

The plans described above are all individual bonus plans. Many times output of individuals cannot be measured. Similarly, the output of individual is dependent on the performance of the group. In such cases, rather than implementing individual bonus systems, group bonus system is implemented. The total amount of bonus, which is determined according to productivity, can then be shared equally or in agreed proportion between the group members. The main objects of group bonus system are as follows:-

- (a) Creation of team spirit
- (b) Elimination of excessive waste of materials and time
- (c) Recognition of group efforts
- (d) Improving productivity

Different Group Bonus Schemes in use are as follows:-

- (i) **Budgeted Expenses Bonus:** Under this system, bonus is based on the savings in actual total expenditure compared with the budgeted expenditure.
- (ii) **Cost Efficiency Bonus:** In this method, standards are set for expenses like material, labour and overheads. The actual expenditure against these standards is measured and if there is a savings in actual expenditure as compared to the standards, a portion of such savings is distributed as bonus amongst the workers.
- (iii) **Pristman System:** In this method, production standards are set in units or points and actual production is compared with the standards. If the actual production exceeds the standard, the workers are paid additional wages equal to the percentage of output over standard. Obviously no bonus is



payable if actual production does not exceed the standard production. This method is mainly used in foundries.

- (iv) **Towne Profit Sharing Plan:** In this method standards are set for costs [mainly labour cost] and the actual cost is compared with the standards. If there is a saving in the costs, the saving is shared by workers and supervisory staff in agreed proportion. The principle behind this method is that if there is a saving in the cost, not only the workers but the supervisory staff should also get the reward because the cost reduction is the joint efforts of both the types of staff. Hence both, workers and supervisors share it.
- (v) **Waste Reduction Bonus:** This system of bonus is based on savings in the material cost. If there is a saving in the material cost, the workers share the same in the agreed proportion. This system is generally used in industries where cost of material is very high.
- (vi) **Rucker Plan:** The amount of bonus is linked with 'value added' in this system. The 'value added' is obtained by deducting the cost of material and services from sales value. In other words, value added is the total of labour, overheads and profits. Under this plan, employees receive a constant proportion of value added. For example, if the target ratio of labour cost to value added is 70%, and the actual ratio comes to 68%, 2% of the actual value added is distributed as group bonus, so that the ratio of direct labour cost to value added is maintained at 70%. Normally instead of distributing the entire bonus, some proportion is distributed and the remaining is transferred to reserve fund.
- (vii) **Scanlon Plan:** This method is similar to the Rucker plan as discussed above except that the ratio of labour cost to the sales is taken instead of direct labour cost to added value. Normally bonus is paid based on average of last three years ratios. A part of the bonus may be transferred to bonus equalization fund for future use when the workers do not get bonus under this scheme.

### Bonus System for Indirect Workers

Indirect workers do not take part in the production process directly but they play important role in the production process. It is difficult to chalk out a bonus system for indirect workers, as there is a difficulty in measuring their output. However it is advisable to plan a bonus system for indirect workers in order to motivate them for better productivity. Bonus to indirect workers is paid on the basis of output of the department, saving in time or expenditure against the budgeted, product quality, reduction of waste and scrap and reduction of labour turnover.

### Indirect Monetary Incentives

These methods aim at giving additional remuneration based on the prosperity of the concern. The following schemes fall in this category:-

- (a) **Profit Sharing:** In this system, the profits of the organization are shared by workers in agreed proportion. The Payment of Bonus Act 1965 in India makes it mandatory to pay minimum bonus of 8.33% of salary and maximum bonus of 20% of salary to the workers.
- (b) **Co-partnership:** In this system, the workers get an opportunity to participate in the ownership of the organization and to receive the part of share of profits. The employees are given assistance to purchase shares of the company. Thus the employees get dividend and bonus also. These schemes help to boost the morale of workers to a great extent.

### Non-Monetary Incentives

These incentives are given in addition to monetary incentives for further boosting the moral of the employees. Though these benefits do not result in additional remuneration, they help to improve productivity by boosting the morale of the employees.

Some of the non-monetary incentives are as follows:-

- (a) Free education and training
- (b) Medical benefits



- (c) Subsidized canteens
- (d) Superannuation benefits like pensions, gratuity, life assurance schemes etc
- (e) Sports and recreation facilities, housing facilities, long service awards
- (f) Job security, promotion schemes
- (g) Benevolent funds and welfare fund

### **Treatment of some of the Employee Cost items in Costing**

#### **(a) Supervisors salary / Foreman's Salary**

The foreman is mainly concerned with the supervision of man and machines in the workshop and so his salary is 'works indirect expenses' and must be charged to Works Expenses Account and included in works overhead. It is apportioned on the basis of degree of supervision required on such machine or men.

If he devotes equal time for all the machines his salary should be equally charged off against all of them. In case he devoted more time to a particular machine or to a particular batch of workers, proportionately higher share of his salary should be borne by that particular machine or batch of workers.

#### **(b) Bonus Under Payment of Bonus Act, 1965**

The Payment of Bonus Act, 1965 provides that to the eligible employees a minimum bonus @ 8-1/3% of gross annual earning will have to be paid irrespective of profits made or losses incurred. If there is adequate profit a higher bonus is paid but upto the maximum limit of 20% of gross earnings. Therefore it is clear that the minimum bonus is a definite charge against profit because even in case of loss this bonus is payable and according to the classification of labour-direct or indirect- should be included in direct labour cost or production overhead. The portion of bonus over and above the minimum is based on profit and should be charged off to Costing Profit and Loss Account and not taken into the cost at all. However, some accountants argued that this portion of bonus should also be taken into the cost in appropriate heads of Direct Labour or Production Overhead. But the former treatment should be taken as more sensible.

#### **(c) Leave Travel Assistance**

Leave Travel Assistance is paid to practically all the employees presently and therefore can be considered as a regular element of labour or staff cost as the case may be. This expenditure is of a fixed nature and can be easily predetermined. Depending whether the assistance is payable to direct labour, indirect labour or staff the expenditure should be treated as Direct Labour Cost, Production Overhead Cost or Administrative Selling Overhead Cost and should be appropriately charged.

#### **(d) Night Shift Allowance**

It is customary practice that the persons working in night shifts are paid some extra and such an allowance is known as night shift allowance. Such additional expenditure caused by general pressure of work in excess of normal capacity are charged to general production overhead because otherwise job performed during days will be cheaper than the jobs completed during night which by no means a fair proposition. If the additional expenditure is incurred extremely as a result of pressing demands from customers such expenditure should directly be charged to the job concerned. On the other hand if the night shifts are run for a fault of the particular department the night shift allowance should be charged as the departmental overhead applicable to the concerned department.



**(e) Fringe Benefits**

Fringe benefits are those expenses which are spent by an employer against the individual employees for their welfare. Normally such expenses do not form a part of their pay packet, e.g., ESI contribution made by an employer. Such expenses may be recovered separately as a percentage on labour cost or at an hourly rate. Alternatively, those may be treated as overheads and apportioned to cost centres on the basis of wages/salary cost.

**(f) Work on Holidays and Weekly off Days**

Usually work on such days is to be paid at a higher rate than the normal days' rate. The extra payment involved is treated in the same manner as in the cases of **overtime premium** as stated before (refer treatment of overtime). Normal wages are charged direct to the work orders/ job/process handled during the period.

**(g) Attendance Bonus**

This is paid to workers based on satisfactory attendance over a stated period and is a fringe benefit. The cost is to be collected under a standing order number and charged as a departmental overhead as the expenses cannot be allocated to cost units directly.

In case the cost is disproportionate from months to months, a proportionate amount may be charged in each period to avoid variation in cost.

When the cost is of a regular nature it may be booked as direct wages and charged by an inflated rate over the Direct Labour Cost. But this is however, not a sound policy.

**(h) Employer's contribution to Employees' Provident Fund**

This is an obligatory charge under the Employees Provident Fund Act of 1952 and the scheme framed there under. This should be treated as part of direct wages of workers. The direct wages paid should be inflated for the cost involved and the products of jobs charged at an inflated rate. An alternative treatment can be made as such that the contribution for the indirect workers is an item of overhead.

**(i) Lost time due to a major overhauling of a machine as result of severe breakdowns**

Manufacturing concerns having a number of machines in the factory usually follow a maintenance schedule whereby the entire factory is overhauled once a year. The related cost of such period consisting mainly of fixed cost is estimated and apportioned as a manufacturing/factory overhead over the annual production. But a sudden and severe breakdown may upset the production plan and call for major overhaul of machine. Such an occurrence is certainly abnormal and all costs related to the breakdown and overhaul should be collected through a separate standing order number and transferred to the costing Profit and Loss Account thereby into distorting the normal cost of production

**Labour Turnover**

Labour Turnover of an organisation is change in the labour force during a specified period measured against a suitable index. The rate of Labour Turnover in an industry depends upon several factors such as, nature of the industry, its size, location and composition of the labour force. A controlled level of Labour Turnover is considered desirable because it helps the firm to adjust the size of its labour force in response to needs such as for seasonal changes or changes in technology.

**Causes of Labour Turnovers**

The causes giving rise to high labour turnover may be broadly classified under the following the heads:

- (i) Personnel Causes:** Workers may leave employment purely on personal grounds, e.g.,
  - (a) Dislike for the job, locality or environments



- (b) Domestic troubles and family responsibilities
- (c) Change of line for betterment
- (d) Retirement due to old age and ill health
- (e) Death

In all such cases, personal factors count the most and employer can practically do nothing to help the situation.

**(ii) Unavoidable Causes :** In certain circumstances it becomes obligatory on the part of the management to ask some of the workers to leave. These circumstances are:

- (a) Retrenchment due to seasonal trade, shortage of any material and other resources, slack market for the product, etc.
- (b) Discharge on disciplinary grounds
- (c) Discharge due to continued or long absence

**(iii) Avoidable Causes:** Under this head, may be grouped the causes which need the attention of the management most so that the turnover may be kept low by taking remedial measures. The main reasons for which workers leave are:

- (a) Unsuitability of job
- (b) Low pay and allowance
- (c) Unsatisfactory working conditions
- (d) Unhappy relations with co-workers and unsatisfactory behaviour of superiors
- (e) Dispute between rival trade unions
- (f) Lack of transport, accommodation, medical and other factors
- (g) Lack of amenities like recreational centres, schools, etc.

The above causes may also be classified in a different manner under three heads, viz., Financial Causes, Social and Economic Causes and Psychological Causes relating to human relationship.

### Measurement of Labour Turnover

It is essential for any organisation to measure the Labour Turnover. This is necessary for having an idea about the turnover in the organisation and also to compare the Labour Turnover of the previous period with the current one. The following methods are available for measurement of the Labour Turnover:-

**(a) Additions Method:** Under this method, number of employees added during a particular period is taken into consideration for computing the Labour Turnover. The method of computing is as follows.

$$\text{Labour Turnover} = (\text{Number of additions}/\text{Average number of workers during the period}) \times 100$$

**(b) Separation Method:** In this method, instead of taking the number of employees added, number of employees left during the period is taken into consideration. The method of computation is as follows.

$$\text{Labour Turnover} = (\text{Number of separations}/\text{Average number of workers during the period}) \times 100$$

**(c) Replacement Method:** In this method neither the additions nor the separations are taken into consideration. The number of employees replaced is taken into consideration for computing the Labour turnover.

$$\text{Labour Turnover} = (\text{Number of replacements}/\text{Average number of workers during the period}) \times 100$$



**(d) Flux Method:** Under this method Labour Turnover is computed by taking into consideration the additions as well as separations. The turnover can also be computed by taking replacements and separations also. Computation is done as per the following methods.

Labour Turnover =  $\frac{1}{2}$  [Number of additions + Number of separations] / Average number of workers during the period  $\times 100$

Labour Turnover =  $\frac{1}{2}$  [Number of replacements + Number of separations] / Average number of workers during the period  $\times 100$

### Cost of Labour Turnover

Increasing Labour Turnover is a double edged malady. It reduces the productivity of labour and resulting in high costs. The cost of Labour Turnover may be analyzed under two broad headings, Preventive Cost and Replacement Costs. Preventive Costs refer to all those items of expenditure which are incurred in order to keep the workers satisfied and thus to act as discouragement against leaving employment. Replacement Costs are those costs which are incurred for the recruitment and training of new hands and the resulting losses, wastages and lowering of productivity due to the inexperience and inefficiency of the new labour force.

### Preventive Costs may be further grouped under the following heads

#### 1. Personnel administration

Most concerns would have a Personnel Department which is entrusted with recruitment, training, and other problems arising out of the employment of the labour force. Obviously, the entire expenditure of the department cannot be treated as labour turnover costs but a portion of the costs which related to the efforts of the Personnel Manager in maintaining good relationship between the management and the staff should be treated as Preventive Labour Turnover Cost. The labour force remains satisfied if properly looked after and if grievances are sympathetically considered.

#### 2. Medical Service (Preventive and Curative)

Care for own health and that of family members gets prior consideration with the workers who prefer those concerns where medical services are available. Further, a healthy worker is an asset of the firm as he is able to make substantial contribution towards higher efficiency and productivity.

#### 3. Welfare activities and Schemes

These include facilities like subsidised canteens, co-operative store, laundry and washing services, sports, housing schemes, transport, and educational facilities. These facilities are as good as higher wages offering incentive to the worker to stay with the firm.

#### 4. Miscellaneous Schemes such as Pension or Provident Fund Schemes, Bonus, High Wage and Other Incentive Schemes

Greater the advantage these prerequisites offer, the lower will be the rate of Labour Turnover.

### Replacement Costs consist of the following:

#### 1. Loss of output due to delay in obtaining new workers

As suitable workers may not be available readily, there is a time gap before a new worker can replace the old one. During this period, some output may be maintained by retaining surplus labour force to meet such contingencies or by working overtime. All such extra cost should be taken as labour turnover cost.

#### 2. Employment Department Expenses

With the increase in the tempo of recruitment, additional work is thrown on the Employment or Personnel Department. Administrative expenditure is incurred for the selection, test and medical examination of the new hands for writing initial document like service records, fund accounts, etc.



### 3. Induction Training for new workers

Unless skilled workers are recruited (more likely on higher rates of pay ) who can be at right way put on jobs, the average worker has to be given some induction training before he is fit to be put on his assigned work. For certain categories of skilled and highly skilled jobs, intensive training for some period may be essential.

### 4. Inefficiency of new workers

The efficiency of new hands be generally low, productivity is reduced and cost increases.

### 5. Cost of tool and machine breakage

While on training and the initial stages of work after completion of training, the worker is likely to break tools more frequently on account of his inexperience.

### 6. Cost of Scrap and Defective Work

A new worker is likely to spoil work and although in most cases responsibility can be fixed on him and no wages paid for the scrapped work, the expenditure incurred on material and wages for the earlier operations done on the job becomes waste.

### 7. Cost of Accidents

On account of his inexperience, the new worker is apt to disregard safety rules and he is thus more prone to accidents. It may be noted that the increases in labour costs due to high Labour Turnover contribute to create an inflationary trend in the industry.

### Measures to reduce Labour Turnover

Labour Turnover may be reduced by removing its avoidable causes and taking preventive remedial measures. The various measures may be summarised as follows:

- (i) Efficient, sympathetic and impartial personal administration
- (ii) Effective communication system to keep the workers informed on matters that affect them
- (iii) Improving working conditions and placing the right man on the right jobs
- (iv) Job enrichment to reduce boredom and monotony and to provide job satisfaction
- (v) Introducing fair rates of pay and allowance and incentives, pensions, gratuity, etc.
- (vi) Strengthening welfare measures
- (vii) Augmenting recreational activities and schemes

### Illustration 4

During October 2015, the following information is obtained from the Personnel Department of a manufacturing company. Labour force at the beginning of the month 1900 and at the end of the month 2100. During the month, 25 people left while 40 persons were discharged. 280 workers were engaged out of which only 30 were appointed in the vacancy created by the number of workers separated and the rest on account of expansion scheme. Calculate the Labour Turnover by different methods.

#### Solution:

Computation of Labour Turnover

#### Additions Method:

Number of Additions/Number of average workers during the period =  $280 / 2000 \times 100 = 14\%$

#### Separation Method:

Number of Separations/Number of average workers during the period =  $(25+40)/2000 \times 100 = 3.25\%$

#### Replacement Method:

Number of Replacements / Number of average workers during the period =  $30/2000 \times 100 = 1.5\%$



**Flux Method:**

$\frac{1}{2}$  [Number of Additions + Number of Separations] / Number of average workers during the period  
 =  $[\frac{1}{2}(280 + 65) / 2000] \times 100 = 173/2000 \times 100 = 8.63\%$

**Note:** Average number of workers in all the above methods is computed by taking Opening number of workers + Closing number of workers / 2 = 1900 + 2100/2 = 2000

**Illustration 5**

The management of XYZ Ltd. is worried about the increasing Labour Turnover in the factory and before analyzing the causes and taking remedial steps; they want to have an idea of the profit foregone as a result of Labour Turnover during the last year. Last year's sales amounted to ₹83, 03,300 and the profit/volume ratio was 20%. The total number of actual hours worked by the direct Labour force was 4.45 lakhs. As a result of the delays by the Personnel department in filling vacancies due to Labour Turnover, 1,00,000 potentially productive hours were lost. The Actual Direct Labour hours included 30, 000 hours attributable to training new recruits, out of which, half of the hours were unproductive. The cost incurred consequent on Labour turnover revealed, on analysis the following. Settlement cost due to leaving: ₹43, 820 & Recruitment costs: ₹26,740. Selection costs: ₹12,750, & Training costs: ₹30,490

Assuming that the potential production lost as a consequence of Labour Turnover could have been sold at prevailing prices, find the profit foregone last year on account of Labour Turnover.

**Solution:**

We will have to calculate the profit foregone by calculating the amount of contribution lost and the additional cost that was incurred as a result of the Labour Turnover. This is done in the following manner.

I. Actual productive hours: Actual hours worked – Unproductive training hours  
 = 4,45,000 – 15,000 [50% of 30, 000]  
 = 4,30,000 actual productive hours.

II. Total hours lost: 1,00,000 hrs  
 Sales lost [₹83,03,300 × 1,00,000]/4,30,000 = ₹19,31,000  
 Loss of contribution – 20% of ₹19,31,000 = ₹3,86,200

**Statement Showing Profit Foregone**

	Amount (₹)
Contribution lost:	3,86,200
Settlement cost due to leaving:	43,820
Recruitment cost:	26,740
Selection cost:	12,750
Training cost:	<u>30,490</u>
Profit foregone:	<u>5,00,000</u>

**Illustration 6**

Calculate the total earnings and effective rate of earnings per hour of three operators under Rowan System and Halsey System from the following particulars.

The standard time fixed for producing 1 dozen articles is 50 hours. The rate of wages is ₹1/- per hour.

The actual time taken by three are as follows:-

- A 45 hours
- B 40 hours
- C 30 hours.



**Solution:**

**Computation of Total Earnings of workers under Halsey Plan**

Earnings under Halsey Plan = Hours worked × Rate per hour + (50% × Time saved × Rate per hour)

Worker	Earnings	Effective Rate
A	$E = (45 \times 1) + 50/100 (50-45) \times 1$ = 47.5	Effective Rate = $47.5/45$ = 1.06
B	$E = (40 \times 1) + 50/100 (50-40) \times 1$ = 45	Effective Rate = $45/40$ = 1.125
C	$E = (30 \times 1) + 50/100 (50-30) \times 1$ = 40	Effective Rate = $40/30$ = 1.33

**Computation of Total Earnings of workers under Rowan Plan**

Earnings under Rowan Plan =

$$\text{Hours worked} \times \text{Rate per hour} + \left( \frac{\text{Time saved}}{\text{Time allowed}} \times \text{Hours worked} \times \text{Rate per hour} \right)$$

	Earnings	Effective Rate
A	$E = (45 \times 1) + [50-45 / 50] 45 \times 1$ = 45 + 4.5 = 49.5	Effective Rate = $49.5/45$ = 1.1
B	$E = (40 \times 1) + [50-40 / 50] 40 \times 1$ = 40 + 8 = 48	Effective Rate = $48/40$ = 1.2
C	$E = (30 \times 1) + [50-30 / 50] 30 \times 1$ = 30 + 12 = 42	Effective Rate = $42/30$ = 1.4

**Illustration 7**

A workman takes 9 hours to complete a job on daily wages and 6 hours on a scheme of payment by results. His hourly rate is 25 p. The Material cost of the product is ₹4 and factory overheads are recovered at 150% of the total direct wages. Calculate the factory cost of the product under following methods:-

- (a) Time rate system    (b) Halsey Plan    (c) Rowan Plan.

**Solution:**

**Computation of factory cost under three systems:**

Amount (₹)

	Time Rate System	Halsey Plan	Rowan Plan
Material	4.00	4.00	4.00
Labour <b>(working notes)</b>	2.25	1.88	2.00
Overheads (150% of total direct wages)	3.38	2.82	3.00
<b>Factory Cost</b>	<b>9.63</b>	<b>8.70</b>	<b>9.00</b>

**Working Notes:**

Amount (₹)

	Time Rate System	Halsey Plan	Rowan Plan
Labour	$9 \times 0.25$	$6 \times 0.25 + 1/2 (9-6) \times 0.25$	$6 \times 0.25 + (9-6 / 9) \times 6 \times 0.25$
	<b>2.25</b>	<b>1.88</b>	<b>2.00</b>



**Illustration 8**

A worker under the Halsey method of remuneration has a day rate of ₹12 per week of 48 hours, plus a cost of living bonus of 10 p. per hour worked. He is given 8 hours task to perform, which he performs in 6 hours, he is allowed 30% of the time saved as premium bonus. What would be his earnings under Halsey Plan and Rowan Plan.

**Solution:**

**Computation of earnings of worker under Halsey Plan:**

$$\begin{aligned} \text{Earnings under Halsey Plan} &= \text{Hours worked} \times \text{Rate per hour} + (30\% \times \text{Time Saved} \times \text{Rate per hour}) \\ &= (6 \times 0.25) + 30/100 (8-6) \times 0.25 &= 1.65 \\ (+) \text{ Cost of Living Bonus } (6 \times 0.1) & &= 0.60 \\ \text{Earnings under Halsey Plan} & &= \underline{\underline{\text{₹}2.25}} \end{aligned}$$

**Computation of earnings of worker under Rowan Plan:**

Earnings under Rowan Plan =

$$\begin{aligned} \text{Hours worked} \times \text{Rate per hour} + \left( \frac{\text{Time saved}}{\text{Time allowed}} \times \text{Hours worked} \times \text{Rate per hour} \right) \\ &= (6 \times 0.25) + (8-6 / 8) \times 6 \times 0.25 &= 1.88 \\ (+) \text{ Cost of Living Bonus } (6 \times 0.1) & &= 0.60 \\ & &= \underline{\underline{\text{₹}2.48}} \end{aligned}$$

Earnings under Halsey Plan = ₹2.25

Earnings under Rowan Plan = ₹2.48

**Illustration 9**

In a factory guaranteed wages at the rate of ₹ 1.80 per hour are paid in a 48 hour week. By time and motion study it is estimated that to manufacture one unit of a particular product 20 minutes are taken, the time allowed is increased by 25% . During the week A produced 180 units of the product. Calculate his wages under the following methods:

- (a) Time Rate
- (b) Piece Rate with a guaranteed weekly wage
- (c) Halsey premium Bonus
- (d) Rowan Premium Bonus

**Solution:**

**(a) Calculation of wages under Time Rate System**

$$\begin{aligned} \text{Earnings under time wages} &= \text{TR} \\ &= 48 \times 1.8 = \text{₹}86.4 \end{aligned}$$

**(b) Calculation of wages under Piece Rate with a Guaranteed Wage Rate**

$$\begin{aligned} \text{Normal Time for one unit} &= 20 \text{ minutes} \\ (+) \text{ Relaxation allowance @ 25\%} &= 5 \text{ minutes} \\ \text{Standard Time} &= 25 \text{ minutes} \end{aligned}$$



No. of pieces per hour =  $60/25$  pieces.

Piece Rate = Hourly Rate / No. of pieces per hour  
=  $1.8 \div (60/25)$   
= 0.75

Earnings under Piece Rate =  $180 \times 0.75$  = ₹ 135

**(c) Calculation of wages under Halsey Premium Bonus**

Standard time for actual production =  $180 \times 25 / 60$  = 75 hours

Earnings under Halsey Plan =  
=  $(48 \times 1.8) + 50/100 (75-48) \times 1.8$   
=  $86.4 + 24.3$  = ₹ 110.70

**(d) Calculation of wages under Rowan Premium Bonus**

Standard time for actual production =  $180 \times 25 / 60$  = 75 hours

Earnings under Rowan Plan =  $(48 \times 1.8) + (75-48 / 75) \times (48 \times 1.8)$   
=  $86.4 + 31.104$  = ₹ 117.50

**Illustration 10**

Calculate the earnings of workers A and B under Straight Piece Rate system and Taylor's Differential Piece Rate system from the following particulars:-

Normal rate per hour - ₹1.80

Standard time per unit 20 seconds

Differentials to be applied are:

80% of the piece rate below the standard;

120% of the piece rate at or above standard.

A produced 1,300 units per day of 8 hours & B -1,500 units per day of 8 hours.

**Solution:**

Pieces per minute =  $60/20$  = 3 units

Units per hour =  $60 \times 3$  = 180 units

Normal piece rate =  $1.8 / 180$  = ₹ 0.01

Standard production in actual time =  $8 \times 180 = 1440$  units

**Earnings under Straight Piece Rate:**

Earnings of A =  $1300 \times 0.01$  = ₹ 13.00

Earnings of B =  $1500 \times 0.01$  = ₹ 15.00

**Earnings under Taylor's Differential Piece Rate:**

A's efficiency =  $1300 / 1440 \times 100 = 90.28\%$

= < 100%

A's Earnings =  $1300 \times 0.01 \times 80\%$

= ₹ 10.42

B's efficiency =  $1500 / 1440 \times 100 = 104.17\%$

= > 100 %





$$\begin{aligned} \text{B's Earnings} &= 1500 \times 0.01 \times 120\% \\ &= ₹ 18 \end{aligned}$$

**Illustration 11**

The following particulars apply to a particular job:

Standard production per hour	-	6 units
Normal rate per hour	-	₹ 1.20
Mohan produced	32 units	
Ram produces	42 units	
Prasad produces	50 units	

Calculate the wages of these workers under Merrick Differential Piece Rate System.

**Solution:**

**Calculation of wages of workers under Merrick Differential Piece Rate System**

Normal Piece rate	= 1.2 / 6	= 0.20	
Standard Production	= 6 x 8 (assumed hrs)	= 48 units	
Mohan's efficiency	= 32/48 x 100	= 66.67%	(< 83%)
Mohan's Earnings	= 32 x 0.2	= ₹ 6.4	
Ram's efficiency	= 42/48 x 100	= 87.5%	(> 83 but < 100%)
Ram's Earnings	= 42 x 0.2 x 110/100	= ₹ 9.24	
Prasad's efficiency	= 50/48 x 100	= 104.17%	(> 100%)
Prasad's Earnings	= 50 x 0.20 x 120/100	= ₹ 12	

**Illustration 12**

In a manufacturing concern the daily wage rate is ₹2.50. The standard output in a 6 day week is 200 units representing 100% efficiency. The daily wage rate is paid without bonus to those workers who show up to 66 2/3% of the efficiency standard. Beyond this there is a bonus payable on a graded scale as below:-

- 82% efficiency - 5% bonus
- 90% Efficiency - 9% bonus
- 100% efficiency - 20% bonus

Further increase of 1% for every 1% further rise in efficiency. In a 6 day week A produced 180 units; B 164 units; C 200 units; D 208 units and E 130 units.

Calculate the earnings of these workers.

**Solution:**

A's efficiency	= (180 / 200) x 100 = 90%	
A's Earnings	= (6 x 2.5) + 9% of (6 x 2.5)	= ₹ 16.35
B's efficiency	= (164 / 200) x 100 = 82%	
B's Earnings	= (6 x 2.5) + 5% of (6 x 2.5)	= ₹ 15.75
C's efficiency	= (200 / 200) x 100 = 100%	



$$\text{C's Earnings} = (6 \times 2.5) + 20\% \text{ of } (6 \times 2.5) = ₹ 18.00$$

$$\text{D's efficiency} = (208 / 200) \times 100 = 104\%$$

$$\text{D's Earnings} = (6 \times 2.5) + 24\% \text{ of } (6 \times 2.5) = ₹ 18.60$$

$$\text{E's efficiency} = (130 / 200) \times 100 = 65\%$$

$$\text{E's Earnings} = 6 \times 2.5 = ₹ 15.00$$

**Illustration 13**

Workmen of a particular grade working on 8 hour shift duty are guaranteed a wage of ₹ 32. An incentive scheme is in operation according to which production bonus is earned directly proportional to performance but only after 100% performance is reached. Four workmen A,B,C and D produce 48, 60, 75 and 90 units respectively in 6 hours working on a job which has standard time of 6 minutes per unit as measured work content. Remaining 2 hours of the shift are spent in doing unmeasured work for which no incentive bonus can be paid. Find for each workman:

- The production performance level achieved;
- Total earnings for the day.

**Solution:****Statement showing computation of performance achieved and total earnings of 4 workers:**

	Particulars	A	B	C	D
I	Standard output (6 x 60 / 6)	60	60	60	60
II	Actual output	48	60	75	90
III	Performance level	80%	100%	125%	150%
IV	Wages for measured work (6 x 4)	24	24	24	24
V	Bonus [C = 24 x 25%] [D = 24 x 50%]	--	--	6	12
VI	Wages for unmeasured work (2 x 4)	8	8	8	8
VII	Total earnings (IV + V + VI)	32	32	38	44

**Illustration 14**

The following particulars for the first week of September, 2015 relate to X and Y two workers employed in a factory:

	X	Y
a) Job Completed — units	3,600	4,200
b) Out of above output rejected and unsalable	540	420
c) Time allowed	12 Mts/dozen	3 Hrs./200 units
d) Basic wage rate per hour	₹ 5	₹ 6
e) Hours worked	45	50

The normal working hours per week are fixed at 42 hours. Bonus is paid @ 2/3 of the basic wage rate for gross time worked and gross output produced without deduction for rejected output. The rate of overtime for first 4 hours is paid at time plus 1/3 and for next 4 hours is paid at time plus 1/2.

From the above data calculate for each employed

- Number of bonus hours and amount of bonus earned;
- Total wages earned including basic wages overtime premium and bonus;
- Direct wages cost per 100 saleable units.



**Solution:**

	Particulars	X	Y
1.	No. of units completed	3,600	4,200
2.	Rejected units	540	420
3.	Saleable units	3,060	3,780
4.	Standard time	60 hrs	63 hrs
5.	Actual time worked	45 hrs	50 hrs
6.	Bonus hours	15 hrs	13 hrs
7.	Amount of bonus	50 (15 x 5 x 2/3)	52 (13 x 6 x 2/3)
8.	Overtime wages	20 (3 x 5 x 4/3)	68 [(4 x 6 x 4/3) + (4 x 6 x 3/2)]
9.	Basic wages	210 (42 x 5)	252 (42 x 6)
10.	Total wages (7 + 8 + 9)	280	372
11.	Direct wage cost of 100 saleable units.	9.15 (280 / 3060) x 100	9.84 (372 / 3780) x 100

**Illustration 15**

From the following particulars work out the earnings for the week of a worker under

- (a) Straight Piece Rate
- (b) Differential Piece Rate
- (c) Halsey Premium System
- (d) Rowan System

Number of working hours per week — 48

Wages per hour — ₹3.75

Normal time per piece — 20 Min

Normal output per week — 120 pieces

Actual output for the week — 150 pieces

Differential piece rate — 80% of the piece rate when output is below standard and 120% above standard.

**Solution:**

**Computation of earnings for the week of a worker**

(a) Piece rate =  $(48 \times 3.75) / 120 = ₹ 1.5$

Earnings under Straight Piece Rate =  $150 \times 1.5 = ₹ 225$

(b) Efficiency =  $(150 / 120) \times 100 = 125\% (> 100\%)$

Earnings under Differential Piece Rate =  $150 \times 1.5 \times 120/100$   
= ₹ 270



$$(c) \text{ Standard time for actual production} = 48 \times (150 / 120) = 60 \text{ hrs}$$

$$\begin{aligned} \text{Earnings under Halsey Plan} &= (48 \times 3.75) + 50/100(60 - 48) \times 3.75 \\ &= 180 + 22.5 = ₹ 202.5 \end{aligned}$$

$$\begin{aligned} (d) \text{ Earnings under Rowan Plan} &= (48 \times 3.75) + [(60-48 / 60) \times (3.75 \times 48)] \\ &= 180 + 36 = ₹ 216 \end{aligned}$$

**Illustration 16**

Ten men work as a group. When the weekly production of the group exceeds standard (200 pieces per hour) each man in the group is paid a bonus for the excess production in addition to his wages at hourly rates. The bonus is computed thus:

The percentage of production in excess of the standard amount is found and one-half of this percentage is considered as the men's share. Each man in the group is paid as bonus this percentage of a wage rate of ₹ 3.20 per hour. There is no relationship between the individual workman's hourly rate and the bonus rate. The following is the week's records.

	Hours Worked	Production
Monday	90	22,100
Tuesday	88	22,600
Wednesday	90	24,200
Thursday	84	20,100
Friday	88	20,400
Saturday	<u>40</u>	<u>10,200</u>
	<u>480</u>	<u>1,19,600</u>

- (a) Compute the rate and amount of bonus for the week;  
 (b) Compute the total pay of Jones who worked 41 ½ hours and was paid ₹2 per hour basic and of Smith who worked 44 ½ hours and was paid ₹ 2.50 per hour basic.

**Solution:**

$$\text{Standard production in actual time} = 480 \times 200 = 96,000$$

$$\text{Excess of actual production over standard} = 1,19,600 - 96,000 = 23,600.$$

$$\% \text{ of excess over standard} = (23,600 / 96,000) \times 100 = 24.58\%$$

$$\% \text{ of bonus} = 1/2 \times 24.58 = 12.29\%$$

$$\text{Bonus rate per hour} = 3.2 \times 12.29\% = 0.393$$

$$\text{Total bonus for week} = 480 \times 0.393 = ₹ 188.64$$

**Computation of Total Earnings of Jones & Smith:**

Particulars		Jones		Smith
Basic wages	41.5 x 2	83.00	44.5 x 2.5	111.25
Bonus	41.5 x 0.393	16.31	44.5 x 0.393	17.49
<b>Total Earnings</b>		<b>99.31</b>		<b>128.74</b>

**Illustration 17**

A manufacturer introduces a new machinery into his factory with the result that production per worker is increased. The workers are paid by results and it is agreed for every 2% increases in average individual output, an increase of 1% on the rate of wages will be paid.

At the time the machinery is installed the selling price of the products falls by 8-1/3%. Show the net saving in production costs which would be required to offset the losses expected from the turnover and bonus paid to workers.

	1 <sup>st</sup> period	II <sup>nd</sup> period
No. of workers	175	125
Number of articles produced	16,800	14,000
Wages paid	33,600	
Total Sales	75,600	

**Solution:**

$$\text{No. of units per worker in period I} \quad \text{---} \quad = 16,800 / 175 = 96$$

$$\text{No. of units per worker in period II} \quad \text{---} \quad = 14,000 / 125 = 112$$

$$\text{Increase in production per worker} \quad \text{---} \quad = 16 \text{ units}$$

$$\% \text{ of increase in output} = 16/96 \times 100 \quad \text{---} \quad = 16 \frac{2}{3} \%$$

$$\text{Wages in Period I} = 33,600$$

$$\text{Wages in Period II} = 33,600 \times (125 / 175) = 24,000$$

$$\text{Increase in wages} = 24,000 \times 8.33\% [16.67 \times \frac{1}{2} = 8.33] = 2,000$$

$$\text{Sales in Period I} = 75,600$$

$$\text{Sales in Period II} = 75,600 \times (14,000 / 16,800) = 63,000$$

$$\text{Decrease in Sales} = 63,000 \times 8 \frac{1}{3} \% = 5,250$$

$$\text{Total loss due to increase in wages \& reduction in sales} = 5,250 + 2,000$$

$$= 7,250$$

To offset the loss, the saving in other must be ₹ 7,250

**Illustration 18**

A work measurement study was carried out in a firm for 10 hours and the following information was generated.

Units produced	:	350
Idle time	:	15%
Performance rating	:	120%
Allowance time	:	10% of standard time.

What is the standard time for task?

**Solution:****Calculation of standard time for task**

Total time = 10 x 60	= 600 minutes
(-) Down time or Idle time @ 15%	= <u>90 minutes</u>
Actual time	= <u>510 minutes</u>
Normal Time = 510 x 120%	= 612 minutes
(+) Relaxation allowance (10% or 1/10 on standard time i.e. 1/9 on normal time)	= <u>68 minutes</u>
Standard time for job	= <u>680 minutes</u>
Standard time for each unit = 680/350	= 1.943 minutes

**Illustration 19**

The extracts from the payroll of M/s. Maheswari Bros. is as follows:-

Number of employees at the beginning of 2015	150
“ “ “ “ “ “ “ end of 2015	200
“ “ resigned	20
“ “ discharged	5
“ replaced due to resignation and discharges	20

Calculate the Labour Turnover Rate for the factory by different methods.

**Solution:**

- 1) Separation Method =  $25 \div (150 + 200 / 2) \times 100$   
=  $0.1429 \times 100$   
= 14.29 %
- 2) Replacement Method =  $(20 / 175) \times 100$   
= 11.43%
- 3) Flux Method =  $(25 + 20) \div 175 \times 100$   
= 25.71%

**Illustration 20**

In a factory bonus to workman is paid according to Rowan Plan. Time allotted for a job is 40 hours and the normal rate of wages is ₹ 1.25 per hour. The factory overhead charges are 50 paise per hour for the hours taken.

The factory cost of a work order, executed by a worker is ₹ 161.875. The cost of material in each case is ₹100.

Calculate the hours of time taken by the workman to complete the work order.



**Solution:**

Let 'T' be the time taken by worker.

$$\begin{aligned} \text{Earnings} &= 1.25 T + [(40-T) / 40] \times [1.25 T] \\ &= 1.25 T + [(50T - 1.25 T^2) / 40] \\ &= [50T + 50 T - 1.25T^2] / 40 \\ &= [100 T - 1.25T^2] / 40 \end{aligned}$$

Materials + Wages + Factory Overheads = Factory Cost

$$\begin{aligned} \Rightarrow 100 + [100 T - 1.25T^2] / 40 + 0.5 T &= 161.875 \\ \Rightarrow 4000 + 100 T - 1.25T^2 + 20T &= 6475 \\ \Rightarrow 1.25T^2 - 120 T + 2475 &= 0 \\ \Rightarrow 5T^2 - 480 T + 9900 &= 0 \\ \Rightarrow T^2 - 96T + 1980 &= 0 \end{aligned}$$

$$T = \frac{96 \pm \sqrt{9216 - 7920}}{2}$$

$$T = \frac{96 \pm 36}{2}$$

T = 66 (or) 30

T = 30 hours (because actual time should not be more than standard time).

**Illustration 21**

Two fitters, a labourer and a boy undertake a job on piece rate basis for ₹1,290. The time spent by each of them is 220 ordinary working hours. The rates of pay on time rate basis, are ₹1.50 per hour for each of the two fitters, ₹1 per hour for the labourer and ₹0.50 per hour for the boy.

The amount of piece-work premium and the share of each worker, when the piece -work premium is divided proportionately to the wages paid.

Compute the selling price of the above job on the basis of the following additional data:-

Cost of the direct material ₹2,010; works overhead at 20% of prime cost; selling overhead at 10% of works cost and profit at 25% on cost of sales.

**Solution:**

**Statement showing computation of earnings of each person**

Amount (₹)

Particulars	F <sub>1</sub>	F <sub>2</sub>	Labourer	Boy	Total
Basic wages	330 (220x1.5)	330	220 (220x1)	110 (220x0.5)	990
Bonus	100	100	67	33	300
	430	430	287	143	1290

**Computation of Selling Price of Job**

Particulars	Amount (₹)
Materials	2,010
Labour	1,290
Prime Cost	3,300
(+) Works Overhead @ 20%	660
Works cost	3,960
(+) S & D overheads @ 10%	396
Cost of sales (or) Total Cost	4,356
(+) Profit @ 25%	1,089
Selling Price	5,445

**Illustration 22**

Two workmen, Vishnu and Shiva, produce the same product using the same material. Their normal wage rate is also the same. Vishnu is paid bonus according to the Rowan System, while Shiva is paid bonus according to Halsey System. The time allowed to make the product is 100 hours. Vishnu takes 60 hours while Shiva takes 80 hours to complete the product. The factory overhead rate is ₹10 per man-hour actually worked. The factory cost for the product for Vishnu is ₹7,280 and for Shiva it is ₹7,600.

You are required:-

- to find the normal rate of wages;
- to find the cost of materials;
- to prepare a statement comparing the factory cost of the products as made by the two workmen.

**Solution:**

Let 'R' be the wage rate and 'M' be the material cost.

$$\begin{aligned}\text{Earnings of Vishnu} &= 60 R + [(100-60) / 100] \times [60R] \\ &= 60R + 24R = 84R\end{aligned}$$

Material + Wages + Factory Overheads = Factory Cost.

$$M + 84R + 600 = 7,280$$

$$\Rightarrow M + 84 R = 6,680 \quad \rightarrow (1)$$

$$\text{Earnings of Shiva} = 80 R + 50\% \text{ of } (100-80) \times R$$

$$= 80 R + 10 R$$

$$= 90 R$$

Material + Wages + Factory Overheads = Factory Cost.

$$M + 90R + 800 = 7,600$$

$$\Rightarrow M + 90 R = 6,800 \quad \rightarrow (2)$$

Solving Equation (1) & (2), we get

$$M + 84 R = 6,680$$

$$M + 90 R = 6,800$$

$$- 6R = -120$$

$$R = 20$$





Substitute the value of 'R' in Equation (2), we get

$$M + 90 R = 6,800$$

$$\Rightarrow M + 90 (20) = 6,800$$

$$\Rightarrow M + 1800 = 6,800$$

$$\Rightarrow M = 5,000$$

$$\begin{aligned} \text{Wages of Vishnu} &= (60 \times 20) + [(100-60) / 100] \times [60 \times 20] \\ &= 1200 + 480 = ₹ 1680 \end{aligned}$$

$$\begin{aligned} \text{Wages of Shiva} &= (80 \times 20) + 50\% (100 - 80) \times 20 \\ &= 1600 + 200 = ₹ 1800 \end{aligned}$$

- (a) Normal Rate of wages = ₹ 20
- (b) Material Cost = ₹ 5,000
- (c) Statement comparing the factory cost of the products as made by the two workmen.

Particulars	Vishnu	Shiva
Material	5,000	5,000
Labour	1,680	1,800
Overheads	600	800
Factory Cost	7,280	7,600

**COST ACCOUNTING STANDARD-7 (Limited Revision 2017): EMPLOYEE COST**

Employee cost: The aggregate of all kinds of consideration paid, payable and provisions made for future payments for the services rendered by employees of an enterprise (including temporary, part time and contract employees). Consideration includes wages, salary, contractual payments and benefits, as applicable or any payment made on behalf of employee. This is also known as Labour Cost.

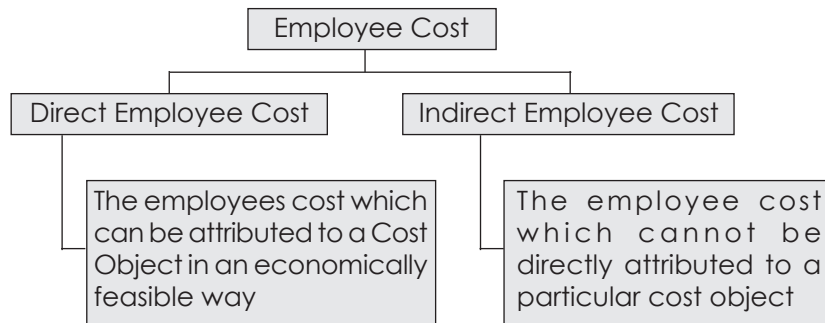

**Principles of Measurement of Employee Cost:** The principles to be followed for measurement of employee cost are:

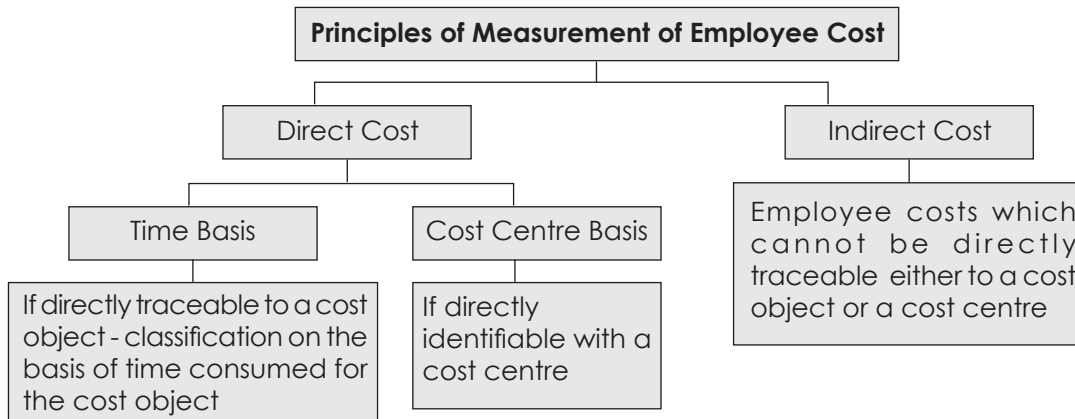

**Measurement of Employee Cost: Inclusions and Exclusions:**

The following items are to be '**included**' for the purpose of measuring employee cost:

- (i) Any payment made to an employee either in cash or kind
- (ii) Gross payments including all allowances payable and includes all benefits
- (iii) Bonus, ex-gratia, sharing of surplus, remuneration payable to Managerial personnel including Executive Directors and other officers
- (iv) Any amount of amortization arising out of voluntary retirement, retrenchment, termination, etc
- (v) Variance in employee payments/costs, due to normal reasons (if standard costing system is followed)
- (vi) Any perquisites provided to an employee by the employer

The following items are to be '**excluded**' for the purpose of measuring employee cost:

- (i) Remuneration paid to Non-Executive Director
- (ii) Cost of idle time [ = Hours spent as idle time x hourly rate]
- (iii) Variance in employee payments/costs, due to abnormal reasons ( if standard costing system is followed)
- (iv) Any abnormal payment to an employee – which are material and quantifiable
- (v) Penalties, damages paid to statutory authorities or third parties
- (vi) Recoveries from employees towards benefits provided – this should be adjusted/reduced from the employee cost
- (vii) Cost related to labour turnover – recruitment cost, training cost and etc
- (viii) Unamortized amount related to discontinued operations.

**Illustration 23****Measurement of Employee Cost**

Basic pay ₹5,00,000; Lease rent paid for accommodation provided to an employee ₹2,00,000, amount recovered from employee ₹40,000, Employer's Contribution to P.F. ₹75,000, Employee's Contribution to P.F. ₹75,000; Reimbursement of Medical expenses ₹67,000, Hospitalisation expenses of employee's family member borne by the employer ₹19,000, Festival Bonus Rs.20,000, Festival Advance ₹30,000. Compute the Employee cost.

**Solution:**

Computation of Employee Cost

	Particulars	Amount (₹)
	Basic Pay	5,00,000
<b>Add</b>	Net cost to employer towards lease rent paid for accommodation provided to an employee  [ = lease rent paid less amount recovered from employee] = [2,00,000 (-) 40,000]	1,60,000
<b>Add</b>	Employer's Contribution to PF	75,000
<b>Add</b>	Reimbursement of Medical Expenses	67,000
<b>Add</b>	Hospitalisation expenses of employee's family member paid by the employer	19,000
<b>Add</b>	Festival Bonus	20,000
	<b>Employee Cost</b>	<b>8,41,000</b>

**Note:**

- (i) Festival advance is a recoverable amount, hence not included in employee cost.
- (ii) Employee's contribution to PF is not a cost to the employer, hence not considered.

**Illustration 24****Measurement of Employee Cost (with special items)**

Gross pay ₹10,30,000 (including cost of idle time hours paid to employee ₹25,000); Accommodation provided to employee free of cost [this accommodation is owned by employer, depreciation of accommodation ₹1,00,000, maintenance charges of the accommodation ₹90,000, municipal tax paid for this accommodation ₹3,000], Employer's Contribution to P.F. ₹1,00,000 (including a penalty of ₹2,000 for violation of PF rules), Employee's Contribution to P.F. ₹75,000. Compute the Employee cost.

**Solution:**

Computation of Employee Cost

	Particulars	Amount (₹)
	Gross Pay ( net of cost of idle time) =[10,30,000 (-) 25,000]	10,05,000
<b>Add</b>	Cost of accommodation provided by employer = Depreciation (+) Municipal Tax paid (+) maintenance charges = 1,00,000 + 90,000 + 3,000 = 1,93,000	1,93,000
<b>Add</b>	Employer's Contribution to PF excluding penalty paid to PF authorities [= 1,00,000 (-) 2,000]	98,000
	<b>Employee Cost</b>	<b>12,96,000</b>

**Note:**

- (i) Assumed that the entire accommodation is exclusively used by the employee. Hence, cost of accommodation provided includes all related expenses/costs, since these are identifiable/traceable to the cost centre.
- (ii) Cost of idle time hours is assumed as abnormal. Since it is already included in the gross pay, hence excluded.
- (iii) Penalty paid to PF authorities is not a normal cost. Since, it is included in the amount of contribution, it is excluded.

**Illustration 25****Measurement of Employee Cost (with special items)**

**Trial Balance as on 31.3.2017 (relevant extracts only)**

Particulars	Amount (₹)	Particulars	Amount (₹)
Materials consumed	25,00,000		
Salaries	15,00,000	Special Subsidy received from Government towards Employee salary	2,75,000
Employee Training Cost	2,00,000	Recoverable amount from Employee out of perquisites extended	35,000
Perquisites to Employees	4,50,000		
Contribution to Gratuity Fund	4,00,000		



Particulars	Amount (₹)	Particulars	Amount (₹)
Lease rent for accommodation provided to employees	3,00,000		
Festival Bonus	50,000		
Unamortised amount of Employee cost related to a discontinued operation	90,000		

**Solution:**

Computation of Employee Cost

	Particulars	Amount (₹)
	Salaries	15,00,000
<b>Add</b>	Net Cost of Perquisites to Employees = Cost of Perquisites (-) amount recoverable from employee = 4,50,000 (-) 35,000	4,15,000
<b>Add</b>	Lease rent paid for accommodation provided to employee	3,00,000
<b>Add</b>	Festival Bonus	50,000
<b>Add</b>	Contribution to Gratuity Fund	4,00,000
<b>Less</b>	Special subsidy received from Government towards employee salary	(2,75,000)
	<b>Employee Cost</b>	<b>23,90,000</b>

**Note:**

- (i) Recoverable amount from employee is excluded from the cost of perquisites.
- (ii) Employee training cost is not an employee cost. It is to be treated as an Overhead, hence, not included.
- (iii) Special subsidy received is to be excluded, as it reduces the cost of the employer.
- (iv) Unamortized amount of employee cost related to a discontinued operation is not an includible item of cost.

**Employee cost reporting and measurement of efficiency****Employee cost reporting**

1. **Direct Employee costs shall be presented as a separate cost head in the cost statement:** Direct employees are those who work on a product directly, either manually or by using machines. They are directly involved in the production of a finished product, that can be easily traced to the product. Examples are assembly-line workers in an automobile factory or employee working on spindle / loom in textile industry. Direct Employee cost is to be presented as a separate item in the cost statement.
2. **Indirect Employee costs shall be presented in cost statements as a part of overheads relating to respective functions e.g. manufacturing, administration, marketing etc:** Indirect employee cost is not directly traceable to a cost object / product and forms part of overheads. The word 'overheads' is used for a type of cost that cannot be directly allocated to a cost object or product, but can be assigned to cost objects.



Employees whose services are indirectly related to production include product designers, job supervisors, foreman, product inspectors, and the like. Employee cost of such employees is considered part of Production overheads. Salaries of employees working on administrative activities such as administration, personnel, accounts, and the like are classified as part of administrative overheads. Similarly, salaries of employees engaged in marketing / selling activities and distribution activities are part of Selling and Distribution Overheads.

- The cost statement shall furnish the resources consumed on account of Employee cost, category wise such as wages salaries to permanent, temporary, part time and contract employees piece rate payments, overtime payments, Employee benefits (category wise) etc wherever such items form a material part of the total Employee cost: Direct employee cost is to be exhibited as a separate item in the cost statement as per CAS 7 (Limited Revision 2017).***

### **Measurement of efficiency**

For many businesses, including most small businesses, the most significant cost is labour. Salaries and wages comprise the major line-item expense for most retail and small-scale manufacturing companies, but labour also tends to be responsive to productivity improvements. To reduce labour costs, entrepreneurs should consider measuring employee efficiency and setting aggressive performance targets to get most of their Employee Costs.

### **Measuring Productivity**

Productivity is simply the amount of units of a product or service that an employee handles in a defined time frame. An employee who makes mechanical device might make 20 mechanical devices per hour, or an employee at a coffee shop might service 15 customers per hour. Simple productivity is neither good nor bad, and in service industries, it might vary according to factors beyond the employee's control, like the number of customers who present for service. Productivity is the basic measure of employee work output.

### **Determining Unit of Service (UOS)**

Productivity and efficiency require a defined unit of service. UOS analysis is usually job-specific, and is most relevant to employees who have jobs that are repetitive. For example, a spot welder might have "welds completed" or "parts completed" as his UOS, whereas a housekeeper in a hotel might have "rooms cleaned per shift" as her UOS. Some jobs, particularly professional jobs that have variable output, defy reasonable UOS measurements.

### **Measuring Efficiency**

Efficiency is a ratio of an employee's actual time to perform each UOS against the theoretical time needed to complete it. For example, an employee who packages DVDs might put together 80 DVDs in one hour. If the best-practice target is 100 DVDs in an hour--measured by a time study--then the employee is 80 percent effective and has the capacity to produce 20 more units per hour. It is usually helpful to report separately the percentage of an employee's paid time that is actually spent performing direct work. For example, an employee who is paid for working 8.0 hours but because of meetings and lunch breaks only works 6.0 hours only spends 75 percent of her time being "productive" in terms of UOS analysis. Only the six hours spent working should be factored into efficiency scoring.

### **Benchmarks and Targets**

Some industries have basic benchmarks already established. For example, telephone call centers have service levels that identify the ideal amount of time that common transactions should take, that are consistent across industries. However, most companies will have to establish for themselves how long basic tasks should take, and set performance targets accordingly. The task of baseline measuring should be done with a time study, which averages the amount of time that multiple transactions take or assesses the amount of time an average employee performs the task. It may not be ideal to require employees to be 100 percent efficient, particularly when the employees lack control over their own



productivity--like in customer-service jobs when employees wait for customers to call or stop by. If an employee can never hit 100 percent, then morale may suffer.

### Longitudinal Reporting

The real benefit to measuring employee efficiency is in longitudinal reporting. Calculating efficiency over a period of time can identify opportunities to reorganize staffing, or add or remove employees based on the company's volume of business, and an individual employee's long-term productivity can factor into merit increases and bonuses. Efficiency scoring can also help with predictive modeling. If it takes 90 seconds to produce a mechanical device, and employees are operating at 75 percent efficiency, then instead of producing 40 widgets per hour, only 30 will be produced.

## GLOSSARY

**Abnormal Idle Time:** Abnormal Idle Time arises on account of abnormal causes and is generally charged to Costing Profit & Loss Account.

**Differential Piece Rate:** Differential Piece Rates are applicable for different levels of output below and above the standard.

**Differential Time Rate:** Under Differential Time Rate System of wage payment different hourly rates are fixed for different levels of efficiency. A fixed rate is paid up to a certain level and thereafter the hourly rate increases gradually depending on the efficiency level.

**Direct Labour Cost:** Direct Labour Cost is the cost of remuneration for employee's efforts and skills applied directly to a product or saleable service and which can be identified separately in product costs.

**Direct Labour Cost Rate:** Direct Labour Cost Rate is the rate calculated by dividing the budgeted or estimated overhead cost attributable to a cost centre by the amount of direct labour cost expected to be incurred.

**Employee Cost:** Employee Costs are the benefits paid or payable to the employees of an entity, whether permanent or temporary, for the services rendered by them. It includes payments made in cash or kind.

**Idle Time:** Idle Time is the period of time for which the shop floor is available for production but is not utilised due to shortage of materials, tools, operators etc.

**Indirect Labour Cost:** Indirect Labour Costs are the labour costs which are not charged directly to a product, e. g. supervision.

**Labour Turnover:** Labour Turnover is the rate of change in employee force during a specified period due to resignation, retirement and retrenchment. If the employee turnover is high, it is a signal of instability and may affect the profitability of the firm.

**Normal Idle Time:** Normal Idle Time is the time which cannot be avoided or reduced in the normal course of business. The cost of normal idle time is generally charged to the cost of production.

**Overtime:** Overtime is the time an employee works beyond the normal working hours.

Generally, over time is to be paid to the employees' at double the rate of normal hours.

**Overtime Premium:** Overtime Premium is the amount of extra payment paid to an employee for extra work done.

**Straight Piece Work:** Straight Piece Work system of wage payment is the system whereby wages is paid to the workers on the basis of number of units produced by them irrespective of time spent for production.



**Time Booking:** Time Booking refers to the recording of details of work done and the time spent by an employee on each job or process.

**Time Keeping:** Time Keeping refers to recording and keeping of the employees' attendance time.

**Time Rate System:** Time Rate System is the system of wage payment whereby wages to an employee is paid on the basis of time irrespective of production volume.

**SELF EXAMINATION QUESTIONS:**

1. What is Labour Turnover and what are the costs associated with it?
2. What are the causes of Labour Turnover? Suggest remedial measures to reduce the Labour Turnover?
3. How do you measure Labour Turnover?
4. What are the various methods of Time Keeping and Time Booking? Also distinguish Time Keeping and Time Booking.
5. How do you treat idle time in Cost Accounts as per CAS – 7?
6. How do you treat overtime in Cost Accounts?
7. What are the various wage payment methods?
8. What are the essentials of good remuneration system?
9. What are the advantages and disadvantages of Piece Rate System?
10. How do you treat the following in Cost Accounts:
  - (a) Supervisor's salary
  - (b) Night shift allowance
  - (c) Last time due to major overhauling
11. Write short notes on:
  - (a) Time and Motion Study
  - (b) Works study and Work Measurement.
  - (c) Job Evaluation
  - (d) Merit Rating
  - (e) Straight Piece Rate vs. Differential Piece Rate
  - (f) Halsey Plan
  - (g) Rowan Plan
  - (h) Guide lines for ascertaining the Labour Cost as per CAS – 7
12. State whether the following statements are true or false?
  - (a) Time recording clocks can be successfully used for recording time of workers in large undertakings.
  - (b) Outworkers are those who are sent to sites or customer's premises for performing work.
  - (c) Idle time arises only when workers are paid on time basis.
  - (d) Personnel department is concerned with proper recruitment, placement and training of workers.
  - (e) Wages paid for abnormal idle time are added to wages for calculating prime cost.



- (f) In India, if a worker works for more than 8 hours on any day or for more than 40 hours in a week, he is treated to be engaged in overtime.
- (g) The two principal systems of wage payment are payment on the basis of time and payment on the basis of work done.
- (h) The piece rate system of wage payment cannot be successfully applied where quantity of output can be measured.
- (i) A good system of wage payment should not ensure equal pay for equal work.

[Ans: (True : a; b; c; d; g) (False : e; f; h; i)]

- 13. How to report the employee cost in the Cost Statement?
- 14. Discuss the means to measure Employee efficiency?
- 15. "High wages do not necessarily mean high Labour Cost". Comment.
- 16. Explain in detail "Work Study".
- 17. Write a short note on Job Evaluation and Merit rating.

**PRACTICE PROBLEMS:**

- 18. What will be the earnings of a worker at 60 paise per hour when he takes 100 hours to do a volume of work for which the standard time is 160 hours the plan of payment for bonus is on a sliding scale as under:

Within the first 10% saving in the Standard time, the Bonus is : 40% of the Time Saved.  
Within the second 10% saving in the Standard Time, the bonus is : 50% of the Time Saved.  
Within the third 10% saving in the Standard Time, the bonus is : 60% of the Time Saved.  
Within the Fourth 10% saving in the Standard Time, the Bonus is : 70% of the Time Saved.  
For the rest of the time saved : 75% of the Time Saved.

[Ans: Total earnings ₹ 79.44]

- 19. Using Taylor's differential piece rate system find out the earnings of X and Y from the following particulars:

Standard time per piece	- 20 minutes
Normal rate per hour	- 90 paise
In a 9 hour day : X produced	- 25 units
Y produced	- 30 units

[Ans: X : ₹ 6.23; Y : ₹ 15.75]

- 20. The following are particulars applicable to a work process.

Time rate	- ₹5 per hour.
High task	- 40 units per week.
Piece rate above high task	- ₹6.50 per unit.

In a 40 hour week, the production of the workers:

A - 35 units B - 40 Units C - 41 units D - 52 units

Calculate the wages of the workers under Gantt Task Bonus.

[Ans: A : ₹ 200; B : ₹ 240; C : ₹ 266.5; D : ₹ 338]





21. In a unit, 10 men work as a group. When the production of the group exceeds the Standard output of 200 pieces per hour, each man is paid an incentive for the excess production in addition to his wages at hourly rates. The incentive is at half the percentage, the excess production over the standard hours bears to the standard production. Each man is paid an incentive at the rate of this percentage of a wage rate of ₹2 per hour. There is no relation between the individual work man's hourly rate and the bonus rate.

In a week, the hours worked are 500 hours and total production is 1,20,000 units.

- a) Compute the total amount of bonus for the week.  
 b) Calculate the total earnings of two workers A and B of the group:  
     A worked 44 hours and his basic rate per hour was ₹ 2.20  
     B worked 48 hours and his basic rate per hour was ₹ 1.90

[Ans: a) Total Bonus for the week is ₹ 100

b) Earnings of A : ₹ 105.6; B : ₹ 100.8]

22. In a factory bonus system, bonus hours are credited to the employee in the proportion of time taken which time saved based to time allowed. Jobs are carried forward from one week to another. No overtime is worked and payment is made in full for all units worked, and including those subsequently rejected.

From the following information you are required to Calculate for each employee

- (a) The bonus hours and amount of bonus earned;  
 (b) The total wages cost; and  
 (c) The wages cost of each good unit produced.

	A (₹)	B (₹)	C (₹)
Basic wage rate/hour	0.25	0.40	0.30
Units produced	2,500	2,200	3,600
Time allowed/100 units	2 hr.36 min	3 hrs.	1 hrs.30 min.
Time taken	52 hrs.	75 hrs.	48 hrs.
Rejects	100 units	40 units	400 units.

[Ans: A : 13 hrs; B : Nil; C : 6 hrs

Amount of bonus A : ₹ 2.6; B : Nil; C : ₹ 1.6

Total wages cost A : ₹ 15.6; B : ₹ 30; C : ₹ 16

Cost of good units produced A : ₹ 0.0065; B : ₹ 0.0139; C : ₹ 0.005]

23. In a factory bonus to workman is paid according to using the Rowan plan. Time allotted for a job is 40 hours and the normal rate of wages is ₹ 1.25 per hour. The factory overhead charges are 50 paise per hour for the hours taken.

The factory cost of a work order executed by a worker is ₹ 155.468. The cost of material is ₹100.

Calculate the hours of time taken by the workman to complete the work order.

[Ans: Actual hrs 25]

### Multiple Choice Questions

1. In which of the following incentive plan of payment, wages on time basis are not Guaranteed?  
 A. Halsey plan  
 B. Rowan plan  
 C. Taylor's differential piece rate system  
 D. Gantt's task and bonus system



2. Under the high wage plan, a worker is paid
  - A. At a time rate higher than the usual rate
  - B. According to his efficiency
  - C. At a double rate for overtime
  - D. Normal wages plus bonus
3. Cost of idle time arising due to non availability of raw material is
  - A. Charged to costing profit and loss A/c
  - B. Charged to factory overheads
  - C. Recovered by inflating the wage rate
  - D. Ignored
4. When overtime is required for meeting urgent orders, overtime premium should be
  - A. Charged to costing profit and loss A/c
  - B. Charged to overhead costs
  - C. Charged to respective jobs
  - D. Ignored
5. Wages sheet is prepared by
  - A. Time -keeping department
  - B. Personnel department
  - C. Payroll department
  - D. Engineering department
6. Time and motion study is conducted by the
  - A. Time -keeping department
  - B. Personnel department
  - C. Payroll department
  - D. Engineering department
7. Labour turnover is measured by
  - A. Number of workers replaced average number of workers
  - B. Number of workers left / number in the beginning plus number at the end
  - C. Number of workers joining / number in the beginning of the period
  - D. All of these
8. Idle time is
  - A. Time spent by workers in factory
  - B. Time spent by workers in office
  - C. Time spent by workers off their work
  - D. Time spent by workers on their job



9. Over time is
  - A. Actual hours being more than normal time
  - B. Actual hours being more than standard time
  - C. Standard hours being more than actual hours
  - D. Actual hours being less than standard time
10. Time keeping refers to
  - A. Time spent by workers on their job
  - B. Time spent by workers in factory
  - C. Time spent by workers without work
  - D. Time spent by workers on their job
11. Time and motion study is conducted by
  - A. Personal department
  - B. Time keeping department
  - C. Engineering department
  - D. Payroll department
  - E. None of the above
12. Labour productivity is measured by comparing
  - A. Total output with total man-hours
  - B. Added value for the product with total wage cost
  - C. Actual time and standard time
  - D. All of the above
13. If the time saved is less than 50% of the standard time, then the wages under Rowan and Halsey premium plan on comparison gives:
  - A. Equal wages under two plans
  - B. More wages to workers under Halsey plan than Rowan plan
  - C. More wages to workers under Rowan plan than Halsey Plan
  - D. None of the above
14. Idle time is the time under which
  - A. No productivity is given by the workers
  - B. Full wages are paid to workers
  - C. None of the above
  - D. All of the above
15. Identify, which one of the following, does not account for increasing labour productivity
  - A. Motivating workers
  - B. Job satisfaction
  - C. Proper supervision and control
  - D. High labour turnover
  - E. None of the above



16. Under Taylor's differential piece rate scheme, if a worker fails to complete the task within the standard time, then he is paid
- 83% of the piece work rate
  - 175% of the piece work rate
  - 67% of the piece work rate
  - 125% of the piece work rate
  - None of the above

[Ans: C, A, A, B, C, D, A, C, A, B, C, D, C, D, D, A]

**State whether the following statements are True (or) False:**

- Direct employee cost shall be presented as a separate cost head in the financial statement.
- As per the Payment of Bonus Act, 1965 the maximum limit of bonus is 20% of gross earning.
- Flux method is means for measurement of labour turnover.
- Is overtime premium is directly assigned to cost object?
- Idle time represents the wages paid for the time cost during which the workkrs not work.

[Ans: 1. False; 2. True; 3. True; 4. True; 5. True.]

**Fill in the Blanks:**

- In a company there were 1200 employee on the rolls at the beginning of a year and 1180 at the end. During the year 120 persons left services and 96 replacements were made. The labour turnover to flux method is \_\_\_\_\_ %.
- In \_\_\_\_\_ systems, two piece rates are set for each job.
- In \_\_\_\_\_ Systems, basic of wages payment is the quantity of work.
- The formula for computing wages under time rate is \_\_\_\_\_.
- In Halsey plan, a worker gets bonus equal to \_\_\_\_\_ of the time saved.
- Under Grantt Task and Bonus Plan, no bonus is payable to a worker, if his efficiency is less than \_\_\_\_\_.
- Wages sheet is prepared by \_\_\_\_\_ department.
- Cost of normal idea time is charged to \_\_\_\_\_.
- Ideal time arises only when workers are paid on \_\_\_\_\_ basis.
- Normal idle time costs shuld be change to \_\_\_\_\_ which that due to abnormal reasons should be change to \_\_\_\_\_.

[Ans: 9.08, Gaylor's differential piece rate, Piece rate, Hour worked × rate per hour, 50%, 100%, Pay Roll Department, Factory Overhead, Time, Production overhead + Costing P/L A/c]

**Match the following:**

1	Labour turnvoer	A	8.33% of Salary
2	Barth variable sharing plan	B	Work beyond normal working hours
3	Minimum bonus	C	Merit rating
4	Overtime Premium	D	Replacement method
5	Assessment of employee with respect to a job	E	Total Earnings = $R \times \sqrt{S \times H}$

[Ans: 1. D; 2. E; 3. A; 4. B; 5. C]



### 2.3 DIRECT EXPENSES (CAS – 10)

Direct expense or chargeable expense is that which can be allocated to a cost centre or cost unit and indirect expense is that which needs to be apportioned. There may be items of expense direct in relation to some cost centre. Thus rent and rates, heating & lighting, depreciation & insurance are often allocated or charged directly to the appropriate service cost centre, the totals of service department cost are however, apportioned to other cost centres before being absorbed by cost units as overheads. These costs are direct costs of the first cost centre, but indirect costs of other production cost centres, as well as being indirect cost of cost units.

**Direct expenses as defined in CAS-10 (Limited Revision 2017), 'Expenses relating to manufacture of a product or rendering a service, which can be identified or linked with the cost object other than direct material cost and direct employee cost'.**

The more a factory is departmentalized, the greater will be the proportion of expenses which can be classified as direct. Thus cost of medicines, first aid, and other expenses in connection with the medical service are direct expenses of medical service department, but if there is no medical service department, the expenses would have been distributed to all the cost centres at the very beginning.

The following expenses may be treated as direct expenses:-

- (a) Cost of patents, royalty payment;
- (b) Hire charges in respect of special machinery or plant;
- (c) Cost of special patterns, cores, designs or tools;
- (d) Experimental costs and expenditure in connection with models and pilot schemes;
- (e) Architects, surveyors and other consultants fee;
- (f) Travelling expenses to sites;
- (g) Inward charges and freight charges on special material.

A direct expense in relation to a product forms part of the Prime Cost. Indirect expenses are treated as Overheads. In relation to products, direct material is a material that becomes a part of it and can be physically traced in some form in the finished products, where as the direct expenses are cost providing services or other kinds of special charges, but no trace of them can be obtained in the finished product like raw material. Both the direct material and direct expenses forms part of the Prime Cost.

#### **General principles of measurement of Direct Expenses as per CAS-10**

- (a) Identification of direct expenses shall be based on traceability in an economically feasible manner.
- (b) Direct expenses incurred for bought out resources shall be determined at invoice price including all taxes and duties and any other expenditure directly attributable there to net of trade discounts, taxes and duties refundable or to be credited.
- (c) Direct expenses paid/incurred in lump-sum or which are in the nature of one time payment shall be amortized on the basis of estimated output or benefit to be derived from such expenses.
- (d) Finance cost incurred in connection with self generated or procured resources shall not form part of the direct expenses.
- (e) Any subsidy or grant or incentive or any amount received or receivable with respect to any direct expenses shall be reduced for ascertainment of the cost of the cost object.



- (f) Penalties / damages paid to statutory authorities or other third parties shall not be form part of the direct expenses.
- (g) Any change in the cost accounting principles applied for measurement of the direct expenses should be made only if it is required by law or for compliance with the requirements of a Cost Accounting Standard or a change would result in a more appropriate preparation or presentation of Cost Statement of the organization.
- (h) Credit / recoveries relating to direct expenses, material and quantifiable shall be deducted to arrive at the net direct expenses.
- (i) Any abnormal portion of direct expenses where is material and quantifiable shall not form part of the direct expenses.

**The Cost Statement shall disclose the following items of Direct Expenses as per CAS-10:**

- (a) The basis of distribution of direct expenses to cost objects / cost units
- (b) Quantity and rates of items of direct expenses as applicable
- (c) Where direct expenses are accounted at standard cost the price and usage variance
- (d) Direct expenses representing procurement of resources and expenses incurred in connection with resources generated
- (e) Direct expenses paid or payable to related parties
- (f) Direct expenses incurred in foreign currency
- (g) Any subsidy / incentive and any such payment received from direct expenses
- (h) Credits or recoveries relating to the direct expenses
- (i) Any abnormal portion of direct expenses
- (j) Penalties and damages excluded from the direct expenses
- (k) Disclosure shall be made only when material, significant and quantifiable. Disclosures shall be made in the body of the Cost Statement or as a foot note or as a separate schedule.

**Cost Accounting Standard-10 : Direct Expenses**

**Direct Expenses: Expenses relating to manufacture of a product or rendering a service, which can be identified or linked with the cost object other than direct material cost and direct employee cost.**

Examples of Direct Expenses are royalties charged on production, job charges, hire charges for use of specific equipment for a specific job, cost of special designs or drawings for a job, software services specifically required for a job, travelling Expenses for a specific job.

**Measurement of Direct Expenses: Inclusions and Exclusions**

The following items are to be '**included**' for the purpose of measuring employee cost:

- (i) Costs which are directly traceable/identifiable with the cost object
- (ii) Expenses incurred for the use of bought in resources
- (iii) Price variance if such expenses are accounted for at standard cost

The following items are to be '**excluded**' for the purpose of measuring employee cost:

- (i) If not traceable/identifiable should be considered as overheads
- (ii) Finance cost is not a direct expense
- (iii) Imputed cost (example, if the owner of a company engages himself for facilitating the production or gets actively engaged in production or rendering of services, this would be an imputed cost)
- (iv) Recoveries, credits, subsidy, grant, incentive or any other which reduces the cost
- (v) Penalty, damages paid to statutory authorities

**Illustration 1: Measurement of Direct Expenses**

Royalty paid on sales ₹30,000; Royalty paid on units produced ₹20,000, hire charges of equipment used for production ₹2,000, Design charges ₹15,000, Software development charges related to production ₹22,000. Compute the Direct Expenses.

**Solution:**

Computation of Direct Expenses

	Particulars	Amount (₹)
	Royalty paid on Sales	30,000
<b>Add</b>	Royalty paid on units produced	20,000
<b>Add</b>	Hire charges of equipment used for production	2,000
<b>Add</b>	Design Charges	15,000
<b>Add</b>	Software development charges related to production	22,000
	<b>Direct Expenses</b>	<b>89,000</b>

**Note:**

- Expenses are related to either manufacturing of the product or rendering of service
- These costs are directly identifiable and can be linked with the cost object and are not related to direct material cost or direct employee cost. Hence, these are considered as Direct Expenses.

**Illustration 2: Measurement of Direct Expenses – allocation to cost object products (in a multi-product situation)**

A manufacturing unit produces two products X and Y. The following information is furnished:

Particulars	Product X	Product Y
Units produced ( Qty)	20,000	15,000
Units Sold (Qty)	15,000	12,000
Machine Hours utilised	10,000	5,000
Design charges	15,000	18,000
Software development charges	24,000	36,000

Royalty paid on sales ₹54,000 [@ ₹2 per unit sold, for both the products]; Royalty paid on units produced ₹35,000 [@ ₹1 per unit purchased, for both the products], Hire charges of equipment used in manufacturing process of Product X only ₹5,000, Compute the Direct Expenses.

**Solution:**

Computation of Direct Expenses

	Particulars	Product X	Product Y
	Royalty paid on Sales (15000*2) (12000*2)	30,000	24,000
<b>Add</b>	Royalty paid on units produced (20000*1) (15000*1)	20,000	15,000
<b>Add</b>	Hire charges of equipment used in manufacturing process of Product X only	5,000	—
<b>Add</b>	Design Charges	15,000	18,000
<b>Add</b>	Software development charges related to production	24,000	36,000
	<b>Direct Expenses</b>	<b>94,000</b>	<b>93,000</b>



**Note:**

- (i) Royalty on production and royalty on sales are allocated on the basis of units produced and units sold respectively. These are directly identifiable and traceable to the number of units produced and units sold. Hence, this is not an apportionment.
- (ii) No adjustments are made related to units held, i.e. closing stock.

**SELF EXAMINATION QUESTIONS:**

- 1. Write a short note on Direct Expenses.
- 2. What are the disclosure requirements as per CAS-10 (Limited Revision 2017)?
- 3. List down the principle of measurement of Direct Expenses.
- 4. Compute the value of Direct Expenses based on the following data Royalty paid on units produced ₹ 50,000, Software development charges relating to production ₹ 36,000, Design charges ₹ 17,500, Hire charges of equipment used for production ₹ 5,500. [Ans: ₹ 1,09,000]

**Multiple Choice Questions:**

- 1. Royalty paid on sales ₹ 89,000 and Software development charges related to product is ₹ 22,000. Calculate Direct Expenses.  
A. 1,11,100                      B. 1,11,000                      C. 111,110                      D. 1,10,000
- 2. Direct Expenses ——— includes imputed cost.  
A. Shall                      B. Shall not                      C. None of these
- 3. Direct Expenses does not meet the test of materiality can be ——— part of part of overhead.  
A. Treated                      B. Not treated                      C. All of the these                      D. None of these
- 4. Example of Direct Expenses.  
A. Rent                      B. Royalty charged on production                      C. Bonus to employee                      D. None of these
- 5. A manufacturing Industry produces product P, Royalty paid on sales is ₹ 23,500 and design charges paid for the product is 1,500. Compute the Direct Expenses.  
A. 25,000                      B. 22,000                      C. 26,500                      D None of these [Ans: B ,B, A, B, A ]

**State whether the following statement is True (or) False:**

- 1. If an expense can be identified with a specific cost unit, it is treated as direct expense.
- 2. Travelling expenses to site is a direct expense.
- 3. Identification of direct expenses shall be based on traceability in an economically feasible manner.
- 4. CAS 9 is for Direct Expenses as issued by the Cost Accounting Standards Board (CASB) of the Institute of Cost Accountants of India.
- 5. Finance Cost shall form part of Direct Expense.

[Ans: T , T, T, F, F ]

**Fill in the Blanks:**

- 1. Direct Expenses relating to \_\_\_\_\_ or \_\_\_\_\_.
- 2. Penalties/ damages paid to statutory authorities' \_\_\_\_\_ be form part of Direct Expenses.
- 3. A Direct Expenses related to a \_\_\_\_\_ form part of the Prime Cost.
- 4. Direct Expenses incurred for brought out resources shall be determined at \_\_\_\_\_.
- 5. Direct Expenses incurred lump-sum shall be \_\_\_\_\_.

[Ans: Manufacture of a product or rendering of service, Shall Not, Product, Invoice Price, Amortized.]





## 2.4 OVERHEADS (CAS - 3)

An overhead is the amount which is not identified with any product. The name overhead might have come due to the reason of over and above the normal heads of expenditure. It is the aggregate of indirect material, indirect labour and indirect expenditure. The generic term used to denote indirect material, indirect labour and indirect expenses. Thus overheads forms a class of cost that cannot be allocated or absorbed but can only be apportioned to cost units.

In earlier days, overheads were not given much importance, because the prime cost constitutes 50-80% of the total cost. However, with the modern trend towards the mechanisation, automation, and mass production, overhead costs have grown considerably in size and in many undertakings the proportion of overhead costs to the total costs of products is appreciably high. High overheads do not indicate inefficiency if the increase in overheads is due to the following likely causes:

- (a) Improved methods of managerial control like Accountancy, Production Control, Work Study, Cost and Management Accountancy...etc. In the process of reducing costs of other elements, viz. direct material and direct labour, overhead costs are likely to increase.
- (b) Large scale production or mass production.
- (c) Use of costly machines and equipments increases the amounts of depreciation, maintenance expenditure and similar other items of overhead costs.
- (d) Less human efforts are necessary with automatic machines. A major portion of the cost is allocated direct to machines, thus increasing the machine overhead costs.
- (e) Increased efficiency and productivity of labour has the effect of pushing up the overhead to direct labour ratio.

According to CIMA, overhead costs are defined as, 'the total cost of indirect materials, indirect labour and indirect expenses'. Thus all indirect costs like indirect materials, indirect labour, and indirect expenses are called as 'overheads'. Examples of overhead expenses are rent, taxes, depreciation, maintenance, repairs, supervision, selling and distribution expenses, marketing expenses, factory lighting, printing stationery etc. **As per CAS-3, overheads are defined as follows 'Overheads comprise costs of indirect materials, indirect employees and indirect expenses which are not directly identifiable or allocable to a cost object in an economically feasible manner'**

### Overhead Accounting

The ultimate aim of Overhead Accounting is to absorb them in the product units produced by the firm. Absorption of overhead means charging each unit of a product with an equitable share of overhead expenses. In other words, as overheads are all indirect costs, it becomes difficult to charge them to the product units. In view of this, it becomes necessary to charge them to the product units on some equitably basis which is called as 'Absorption' of overheads. The important steps involved in Overhead Accounting are as follows:-

- (a) Collection, Classification and Codification of Overheads.
- (b) Allocation, Apportionment and Reapportionment of overheads.
- (c) Absorption of Overheads.

As mentioned above, the ultimate of Overhead Accounting is 'Absorption' in the product units. This is extremely important as accurate absorption will help in arriving at accurate cost of production. Overheads are indirect costs and hence there are numerous difficulties in charging the overheads to the product units.



Study of Overheads can be better understood from the following diagram:

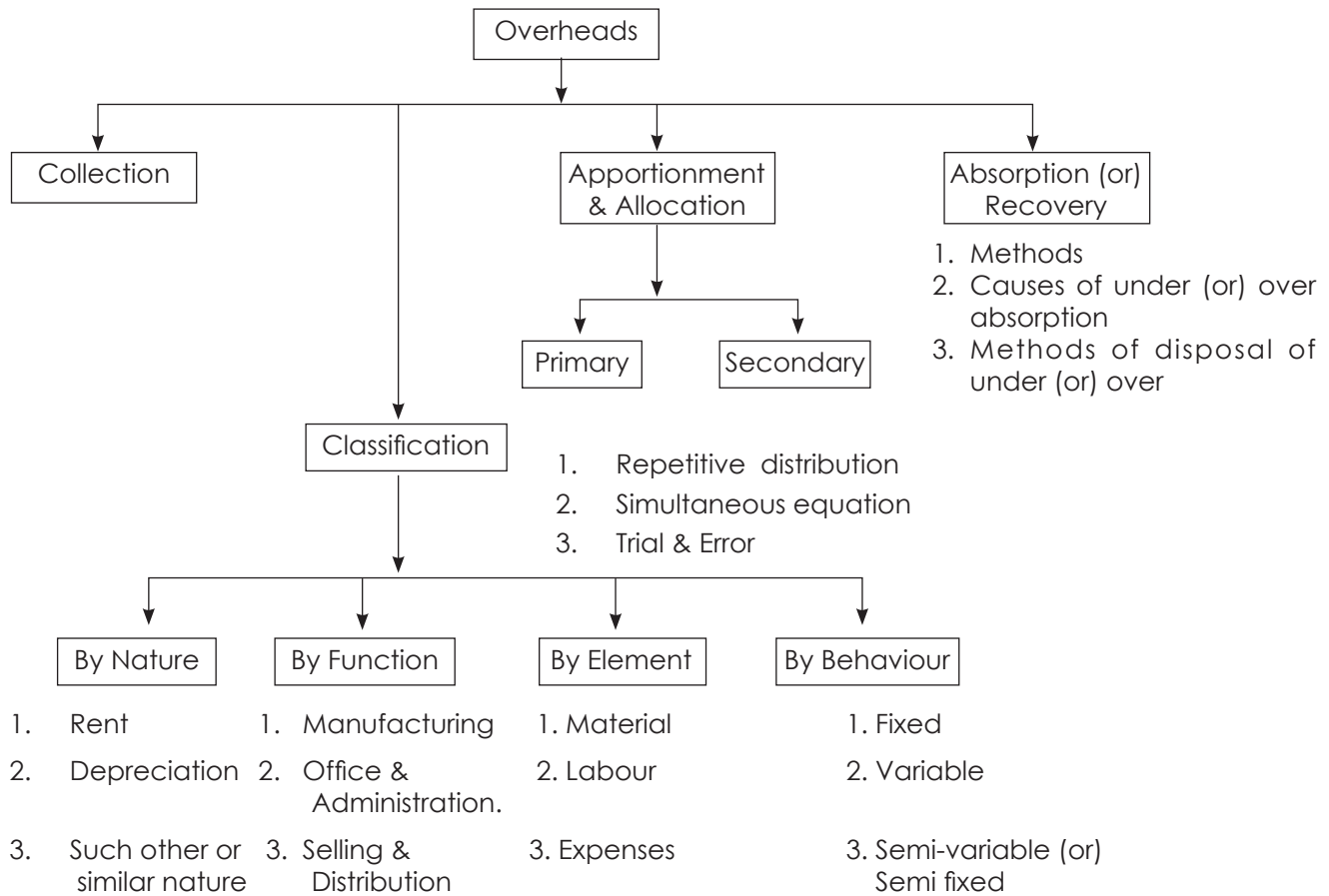

**(a) Collection, Classification and Codification of Overheads**

These concepts are discussed below:-

**Collection of Overheads**

Document	Overhead Costs	Nature
Stores Issue note, purchase voucher	Indirect material	Consumables, lubricants etc.
Payroll sheets, time sheets	Indirect labour	Wages, salaries, contribution to statutory benefits, bonus, incentives, idle time
Cash books	Indirect material, Indirect labour & indirect expenses	All type of costs
Subsidiary records – journal	Indirect material, Indirect labour & indirect expenses	For provisions of costs that are not actually paid for
Other reports	Indirect expenses	Depreciation, scrap, wastage etc.



Overheads collection is the process of recording each item of cost in the records maintained for the purpose of ascertainment of cost of each cost centre or unit.

The following are the source documents for collection of overheads:-

- (i) Stores Requisition
- (ii) Wages Sheet
- (iii) Cash Book
- (iv) Purchase Orders and Invoices
- (v) Journal Entries
- (vi) Other Registers and Records

Source document and the nature of overheads are enumerated as below.

For the purpose of overhead accounting, collection of overheads is very important. It is necessary to identify the indirect expenses and the above mentioned source documents are used for this. Proper collection of overhead expenses will help to understand accurately the total overhead expenses.

### **Classification of Overheads**

Classification is defined by CIMA as, 'the arrangement of items in logical groups having regard to their nature (subjective classification) or the purpose to be fulfilled (Objective classification). In other words, classification is the process of arranging items into groups according to their degree of similarity. Accurate classification of all items is actually a prerequisite to any form of cost analysis and control system. Classification is made according to the following basis:

**Based on Elements:** Indirect Materials, Indirect labour and Indirect expenses.

**Based on Functions of the organisation:** Manufacturing overheads, Administrative overheads, Selling and Distribution overheads, Research & Development overheads.

**Based on the Behaviour:** Fixed Overheads, Variable Overheads & Semi variable overheads.

### **Classification according to Elements**

According to this classification overheads are divided according to their elements. The classification is done as per the following details:-

#### **Indirect Materials**

Materials which cannot be identified with the given product unit of cost centre is called as indirect materials. As per CAS-3 indirect material cost is defined as 'Materials, the cost of which cannot be directly attributed to a particular cost object'. For example, lubricants used in a machine is an indirect material, similarly thread used to stitch clothes is also indirect material. Small nuts and bolts are also examples of indirect materials.

#### **Indirect Labour**

As per CAS-3, indirect employee cost is the employee cost, which cannot be directly attributed to a particular cost object. Wages and salaries paid to indirect workers, i.e. workers who are not directly engaged on the production are examples of indirect wages.

#### **Indirect Expenses**

As per CAS-3, Indirect Expenses are expenses, which cannot be directly attributed to a particular cost object. Expenses such as rent and taxes, printing and stationery, power, insurance, electricity, marketing and selling expenses etc. are the examples of indirect expenses.

### **Functional Classification**

Overheads can also be classified according to their functions.



This classification is done as given below:-

### **Manufacturing Overheads**

As per CAS-3, Indirect Cost involved in the production process or in rendering service. Manufacturing overheads has different names such as Production Overheads, Works Overheads, Factory Overheads. Indirect expenses incurred for manufacturing are called as Manufacturing Overheads. For example, factory power, works manager's salary, factory insurance, depreciation of factory machinery and other fixed assets, indirect materials used in production etc. It should be noted that such expenditure is incurred for manufacturing but cannot be identified with the product units.

Manufacturing is a separate function like administration, selling and distribution. The term manufacturing stands for activities, which begin with receipt of order and end with completion of finished product. Manufacturing Overhead represents all manufacturing costs other than direct materials and direct labour. These costs cannot be identified specifically with or traced to cost object in an economically feasible way. In other words, manufacturing overhead are indirect manufacturing costs. The term overhead is peculiar and therefore, there is a growing tendency to prefer the term indirect manufacturing cost to overhead. Following synonyms have been used for Manufacturing Overhead:-

- (i) Factory overhead;
- (ii) Manufacturing overhead;
- (iii) Factory on cost;
- (iv) Works on cost;
- (v) Factory burden and;
- (vi) Manufacturing expenses.

Given below are a few examples of different items included in different groups of manufacturing overhead:

**Indirect Material Cost:** Glue, thread, nails, rivets, lubricants, cotton waste, etc.

**Indirect Labour Cost:** Salaries and wages of foremen and supervisors, inspectors, maintenance, labour, general labour; idle time etc.

**Indirect Services Costs:** Factory Rent, factory insurance, depreciation, repair and maintenance of plant and machinery, first aid, rewards for suggestions for welfare, repair and maintenance of transport system and apportioned administrative expenses etc.

Manufacturing Overhead further explains in apportionment, allocation and absorption.

### **Administrative Overheads**

Indirect expenses incurred for running the administration are known as Administrative Overheads. As per CAS-3, Administrative Overheads are defined as Cost of all activities relating to general management and administration of an organisation.

As per the functional classification, Administration Overheads comprise of those indirect costs which are related to the general administrative function in the company. Such functions are related to policy formulation, directing the organisation and controlling the operations of the company. Administration overheads are incurred for the benefit of organisation as a whole. Controlling them is difficult for they do not vary with most of the variables viz. production or sales. Examples of such overheads are, office salaries, printing and stationery, office telephone, office rent, electricity used in the office, salaries of administrative staff etc. The size as well as control over these overheads depends largely on decisions of management. Organisations growing very fast face the problem of controlling Administrative Overheads. Multi-location set up leads to duplication of many administrative costs.

### **Collection and Absorption of Administration Overheads**

The collection of overheads is done firstly by nature of the expenses through the chart of accounts. Administrative departments in an organisation could be Corporate Office, Finance and Accounts,



Company Secretary, Human resources, Legal, General Administration. The overheads that are common to all these departments are apportioned on some suitable basis e.g. in the following manner:

- (a) For Office rent, rates & taxes - Floor space as the basis,
- (b) For Depreciation on office building - Floor space as the basis
- (c) For Legal fees - No of cases handled as the basis
- (d) For Salaries of common staff - Ratio of salaries of departments as the basis
- (e) For Typist pool - No of documents typed as the basis

Absorption of the Administrative Overheads into cost units is very difficult. Many times it is advised that these overheads may not be absorbed into product units because of the difficulty and non-relevance of them with production activity. Normally, the Administrative Overheads are totalled together and then using a suitable basis, a rate of recovery is arrived at to absorb the same. It could be mostly a percentage of Works cost or factory cost. Based on the principle of '*charging what the traffic can bear*', the absorption could be on the basis of a percentage of gross profit. Whatever method selected, it will be arbitrary and could lead to erroneous conclusions. A Cost Accountant has to use all the experience and history of the organisation before he selects a particular method to adopt.

### **Treatment of Administration Overheads**

There are three different ways of treating the administration overheads as follows:-

#### **1) Apportion between Production and Selling & Distribution functions**

This treatment is based on the logic that the administrative functions are for the entire company and these functions facilitate both production as well as selling. In other words, the absorption of Administration Overheads would happen through Production and Selling Overheads. This means these overheads lose their identity. The problem is of course, selection of basis to divide these overheads over the two principal functions of production and selling.

#### **2) Transfer to P & L Account**

This method agrees that administrative costs are all time based costs and as such bear no relation what is produced or what is sold. These are mainly of fixed nature. Hence there is no point in dividing them further to be included in the cost of production or cost of selling. They should be simply charged to the P & L Account. However, this may lead to undervaluation of stocks.

#### **3) Treating as a separate addition to cost of production & sales**

In this method, administration is treated as a separate function and is added as a separate line in the cost computation sheet for a job or an order. Here again, the basis for inclusion as a part of cost of a job is a difficult choice. Generally, a percentage of factory cost is taken as a basis. A care needs to be taken to ensure that the Administration Overheads are charged equitably to Cost of Sales, FG stock and WIP as well.

### **Controlling Administration Overheads**

Given the nature of these expenses, they cannot be controlled at the lower level of management. They can be better controlled by top management as they pertain to formulating policy and directing the organisation. The first step in the control mechanism is proper classification of expenses & departmentalisation. The actual expenses are collected for each department and then compared with a bench mark. Deviation are analysed and causes for increase are mitigated by fixing responsibility on the departmental head.



The control benchmarking can be done with respect to:

- (i) Figures of the previous year. Expenses could be compared with the figures of previous year and increase or decrease are analysed. However, comparison with previous year may not help as the condition may have totally changed from one year to the other.
- (ii) Use of budgets. Budgets are estimates for the current year, and they take into account the changed conditions. They also built in the year's complete plan which would factor all changes in the cost structure. It is advisable to compare budgeted overheads with actual for control purpose.
- (iii) Use of standards. Although very scientific, this method is difficult to operate. Administrative activities (being very subjective) cannot be standardised. On a certain level it can be applied e.g. the time taken to process a voucher by accountant can be standardised, or time taken for processing a payment could be standardised.

### **Selling and Distribution Overheads**

As per CAS-3, *Selling Overheads*, also known as *Selling Costs*, are the expenses related to sale of products and include all *Indirect Expenses in sales management for the organization*. Overheads incurred for getting orders from consumers are called as *Selling Overheads*. On the other hand, overheads incurred for execution of order are called as *Distribution Overheads*. As per CAS-3, *Distribution Overheads*, also known as *Distribution Cost*, are the cost incurred in handling a product from the time it is ready for dispatch until it reaches the ultimate consumer. Examples of *Selling Overheads* are sales promotion expenses, marketing expenses, salesmen's salaries and commission, advertising expenses etc. Examples of *Distribution Overheads* are warehouse charges, transportation of outgoing goods, packing, commission of middlemen etc.

The magnitude of S & D Overheads in the total cost would depend on many factors such as nature of the product, type of customers, spread of market, statutory restrictions etc. A consumer product needs heavy expense on advertising. A sale to institutions rather than individual customers needs a different selling effort. Distribution Costs will increase if the spread of the market is large. Some activities cannot be advertised at all such as a Doctor, a Cost Accountant. The total magnitude of S & D Costs and the proportion of selling and distribution efforts will decide the treatment thereof and control mechanisms to be used. For some of selling expenses there may not be a direct relationship with the product. If a company incurs expense on advertising, it may be difficult to relate to a specific product unless it's a product advertisement. But further, there may be a substantial time lag between the expense and the benefit arising out of that. In case of Distribution Costs many of them may be possibly linked to the product.

### **Collection and Absorption of S&D Overheads**

While classifying the S & D Costs are properly bifurcated and coded accordingly. This could be done by having separate account codes for *Selling Overheads* such as: advertising, sale commission, travelling expense, communication, exhibition, market survey, free samples, credit & collection costs, bad debts, and *Distribution* expenses such as: transportation vehicle related expenses, warehousing and storage at different places, depreciation. Depending upon the size of the organization, there may be proper departmentalization of S&D activities. The departments could be:

- Sales head office
- Sales regional offices
- Depots
- Direct selling department
- Dealers management
- Credit and collection (commercial)



The costs are collected through various source documents under the above heads and for the above departments. For absorption, the basis to be used will have practical difficulties, as one will have to look for a relationship between the expenses and the cost unit. Some expenses like sales commission, shipping costs, and direct selling expenses can be absorbed directly. The other expenses can be absorbed on the basis of either sales value, cost of goods sold, gross profit or number of units sold. Out of these the sales value method is the most commonly used.

### **Control over Selling & Distribution Expense**

The S & D Expenses are related to sales and distribution activity which is externally focused. The extent of these expenses depend mainly on external factors like consumer profile, changing habits, technology improvements etc. Controlling these expenses does not mean capping them. It aims at increasing the effectiveness of these expenses e.g. getting maximum sales per rupee of S & D Expenses. For control purpose, a great care should be taken to ensure correct classification and collection of S & D Overheads. The collected expenses must be analysed to assess the effect of them on sales. Such analysis could be done as follows:

- (a) Analysis of sales and S & D Expenses by geographical locations – This could be regions, zones, domestic and international etc.
- (b) Analysis by type of customers - This could be done as institutional, government, retail etc.
- (c) Analysis by products or services – This may be done as range of products, the application of products, brands etc.
- (d) Analysis by salesmen.
- (e) Analysis by channel of distribution – This analysis pertains to wholesalers, retailers, commission agents etc.

The analysis of sales, profits and S & D expenses on the basis of above factors will give a good insight into the performance as well as control over expenses. All these three parameters may be compared with

- Previous year;
- Budget for the current year or
- Standards for the current year

### **Research and Development Overheads**

Research Cost is defined as the cost of searching for new or improved products, new applications of material, or new or improved methods, process, systems or services. In the modern days, firms spend heavily on Research and Development. Expenses incurred on research and development is known as Research and Development Overheads. Research may be of the following types:

- (i) Pure or basic research to gain general know-how regarding the production or market, not directed towards any particular product.
- (ii) Applied research which applies the basic knowledge in practice. i.e improvement of existing products, new process, exploring of new products, improved measures of safety, etc.

Development cost is the cost of the process which begins with the implementation of the decision to use scientific or technical knowledge to produce a new or improved product or to employ a new or improved method, process, system, etc. and ends with the commencement of formal production of that product by that method. Development starts where the research ends. Development cost is the expenditure incurred for putting the results of research on a practical commercial basis.

### **Special features of Research & Development Costs**

The features are as follows:-

- (a) Expenditure is incurred ahead of the actual production and may not be charged to current production.



- (b) The amount of expenditure may often be substantial.
- (c) The expenditure may at times be entirely in fructuous, yielding no tangible results.
- (d) Benefit of the expenditure may be realized over a number of years.
- (e) Difficulty in fixation of standards for control.

### Collection of R&D Overheads

Accumulation of Research and Development Overheads is essential for the following reasons:-

- (a) For review cost to date
- (b) For planning the activities subsequent to research
- (c) For evaluation of performance with relation to past performance or for inter-firm comparison

The collection of R&D Overheads is made through the following documents. Material requisitions, labour time cards, invoices, vouchers (royalty, patent, license. etc). Research & Development expenditure may be identified by its nature i.e basic or applied research or development by the elements of cost, by business sector, by project. Each Research & Development project is allotted a project work order number. Separate series of work orders or codes should be used to distinguish from regular work orders.

R & D overheads can be accumulated as follows:-

- (a) All expenditure under the direct elements (direct material, labour and expenses) must be charged to the work orders.
- (b) Expenses like supervisor salary, material handling charges, maintenance of equipments can be directly allocated to particular research work order.
- (c) Items of general overheads like depreciation of building, depreciation of maintenance equipment, share of purchase department expenses may be suitably apportioned to the research work order.

### Accounting of R&D Overheads

Accounting of Research & Development Cost arise due to the following causes:-

- (a) The expenditure is in the nature of pre-production costs and there is a considerable time lag between the incidence and expenditure and realization of benefit.
- (b) There is no immediate production, or the production is so small that it becomes difficult to charge such costs to products.

It is because of these difficulties that the accounting of Research and Development Costs has been a subject of some controversy. Three methods are available for charging Research and Development Costs as:

- (a) Charging off to the current year Profit & Loss Account
- (b) Capitalization so that cost may be amortized on a long term basis.
- (c) Deferment and charge-off to costs of the next two or three years-a short/medium term amortization

Research and Development may be regarded as a function of production and the Research & Development Costs may be charged to costs to be recovered through the general overhead rates. There are many arguments for and against charging the Research & Development Costs in current revenue. The arguments in support of this method are as follows:-

- (a) All research & development expenses may not result in new processes or saleable products.
- (b) Some of the research & development projects may result in failures.
- (c) These expenses may be incurred simply to maintain the present competitive position of the concern.





- (d) It is difficult to assess the period over which the know-how or knowledge acquired may be spread over.
- (e) It may be more advantageous to recover a substantial portion of the cost immediately, as the life of the new products are uncertain.
- (f) In certain cases, the effect of these research costs on future revenues may be doubtful.

The classification used for cost collection is mostly combination of elemental and functional. The behavioural classification cannot be used for booking of costs; it is used only for analysis and decision making.

Elements	Material	Labour	Expense
Factory or production or manufacturing or works overheads	Nuts & bolts, consumables, lubricants, welding electrodes, cleaning materials, nails, threads, ropes etc.	Salaries & wages to foremen, supervisors, inspectors, maintenance labour, idle time	Factory lighting & heating, factory rent, power & electricity, factory insurance, depreciation on machinery, repairs
Administrative Overheads	Printing & stationery, office supplies	Salary of office staff, managers, directors, and other administrative departments as IT, audit, credit, taxation	General office rent, insurance, telephones, fax, travel, legal fees, depreciation on office assets
Selling Overheads	Price lists, catalogues, mailings, advertising material such as leaflets, danglers, samples, free gifts, exhibition material	Salaries of sales staff & managers, commission on sales, bonus on schemes	Sales office expenses, travelling, subscription to sales magazines, bad debts, rent & insurance of showrooms, cash discount, brokerage, market research
Distribution overheads	Secondary packing, material items used in delivery vans	Salaries of delivery staff such as drivers, dispatch clerk, logistic manager	Carriage outwards, forwarding expenses, rent & insurance of warehouses & depots, insurance, running expenses & depreciation of delivery vans

**Classification based on behaviour**

**Fixed Overheads/Period Costs**

The amount of overhead tends to remain fixed for all volumes of production within a certain range. Examples of Fixed Overheads are Audit fee, Interest on capital, Depreciation of plant & machinery, Insurance, Rent of buildings, etc. A fixed overhead represents constant expenditure incurred during a period without regarding to the volume of production during that period. Even when production completely ceases in a particular period, this constant amount of expenditure will continue to be incurred partially, if not wholly. Therefore the Fixed Overheads are also known as Period Costs. Sometimes these costs are also termed as Shutdown or Stand-by Costs.

### Features of Fixed Costs

Fixed Costs are stated to be by and large uncontrollable, in the sense they are not influenced by the action of a specified member of an undertaking. For example, the supervisor has practically no control over the fixed costs like depreciation of plant & machinery. The production supervisor can only see that the maximum possible utilization of the assets is made.

The fixed overhead amount is constant per period; the cost per unit of production varies with the volume. This variation is inverse since with increase in production, cost per unit decreases as the same amount of fixed overheads is spread over larger units of production.

### Factors affecting the Fixed Overheads

When a plant or a department is completely idle and there is no production, several items of Fixed Overheads disappear. Fixed Overheads are thus, of two types, viz. a lower standing fixed cost when production is nil and a higher running fixed cost when the plant is running. For instance, maintenance expenditure incurred at plant shutdown has to be increased to a higher level when production starts.

Any long term change in the productive capacity of an undertaking also affects the basic characteristic of fixed overhead. Fixed costs are constant for short term periods only, within a limited range of capacity.

Another factor that affects the fixed nature of fixed overhead is the change in basic price level.

Graphical representation of Fixed Costs is depicted as below:

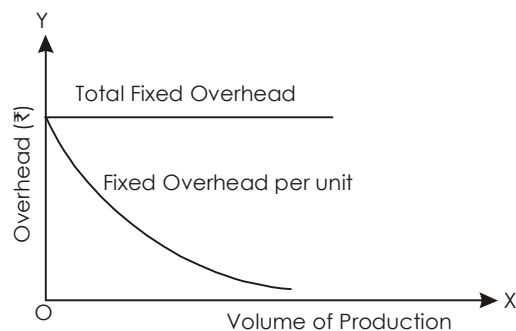

Fixed Costs may be broadly classified into three basic types:-

- (i) Fixed costs that have no casual relationship with the volume of output and are incurred mainly as results of policy decisions of the management. Research, development, design, employee training, advertisement and marketing expenses are examples of this expenditure. Accountants term such costs as discretionary fixed costs (also known as programmed costs or managed costs).
- (ii) Fixed costs that do not change significantly in the short term such as depreciation, rent, etc.
- (iii) Fixed costs that are fixed for short period for a particular capacity, but change considerably when there is a long-term change in the volume or capacity.

### Variable Overheads

Variable Costs are those which vary totally in direct proportion to the volume of output. These costs per unit remain relatively constant with changes in production. Thus Variable Costs fluctuate in total amount but tend to remain constant per unit as production activity changes. Examples are indirect material, indirect labour, lubricants, cost of utilities, etc.

The variable overhead costs seldom reveal the characteristics of perfect variability. i.e an expenditure which varies directly with variation in the volume of output. They simply tend to vary rather than vary



directly in direct proportion of output. We come across three types of variable overhead expenses in actual practice as explained below:-

- (i) 100% variable expenses. For all production the variable expenditure remains constant.
- (ii) The expense per unit of production is low at lower ranges of output but gradually increases as production goes up.
- (iii) The expenses per unit of production are more at lower ranges of output but gradually decrease with the decrease with the increase in production.

Nature of variable expenses is shown as below:-

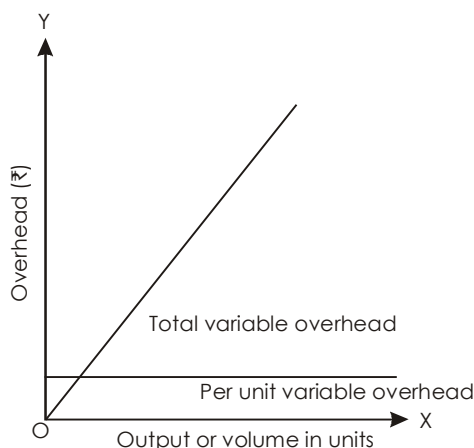

The relationship of fixed and variable overheads with the volume of output is exhibited in the following table. The range of output is considered as 5000-10000 units. Variable overheads are taken at ₹2 per unit and fixed overheads are assumed to be at the level of ₹25000. Can you check for yourself how the graph will look like for the following figures?

Output units	Fixed Overheads	Variable Overheads	Total Overheads	Overheads per unit		
				Fixed	Variable	Total
5000	25000	10000	35000	5.00	2.00	7.00
6000	25000	12000	37000	4.17	2.00	6.17
7500	25000	15000	40000	3.33	2.00	5.33
8000	25000	16000	41000	3.13	2.00	5.13
9000	25000	18000	43000	2.78	2.00	4.78
10000	25000	20000	45000	2.50	2.00	4.50

**Semi-Variable Overheads**

These are a sort of mixed or hybrid costs, partly fixed and partly variable costs. For example Telephone expenses, include a fixed portion of annual charge plus variable charge according to the calls. Thus total telephone expenses are semi-variable.

Semi-variable overheads are of two types:-

- (i) The expenses which change with the change in volume of output, but the variation cost is less than proportionate to change in output. Examples are power & fuel, lighting, repairs and maintenance of buildings, etc.



- (ii) The costs tend to remain constant within certain range of output, then jump up and remain constant for another range and so on.

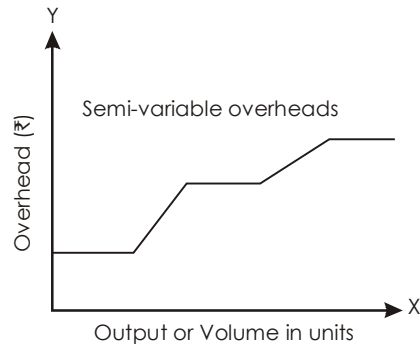

Semi variable cost need to be classified into fixed and variable due to the following reasons:

- Effective Cost Control:** Fixed costs are in the nature of policy costs or discretionary costs and as such can be controlled by the management. However variable costs can be controlled at lower levels. Separation of two elements facilitate the fixation of responsibility, preparation of overhead budget and exercise effective control.
- Decision Making:** The classification is very useful in management decisions relating to utilization of capacity. If cost information is to be of use in such problems, it is essential that fixed and variable costs which behave differently with changes in volume should be segregated.
- Preparation of Break-even Charts:** Separation of fixed and variable cost is essential for the study of cost volume profit relationship and for the preparation of breakeven charts and profit charts.
- Marginal Costing:** The basic requirement of the technique of Marginal Costing is the separation of fixed and variable costs. While the latter are taken into consideration for the determination of Marginal Cost and contribution, the fixed costs are treated separately.
- Method of Absorption Costing:** Separate method may be adopted for determination of rates for fixed and variable costs for absorption in production. Further a separate fixed overhead rate also serves as a measure of utilization of the facilities of the undertaking; any under recovery or under absorption denotes the idle or surplus capacity or production efficiency.
- Flexible Budget:** In a Flexible Budget, the budgeted amounts vary with the levels of activity & fixed cost remains constant. It is the variable cost that varies. Breakup of overhead cost into fixed and variable is therefore necessary for establishment of budget and for the purpose of variance analysis.

#### Methods of classification of semi variable cost in fixed and variable

- Graphical Method** – The costs at number of levels are plotted on a graph, x-axis represents the volume and y-axis represents the amount of expenditure. A straight line known as regression line or line of best fit is drawn between the points, plotted in such a manner that there are equal number of points on both the sides of a line and as far as practicable, pairs of points on either side are in equal distance from the line. Points falling far beyond the line are erratic and are not considered. If the regression line is drawn carefully so that most of the plotted points are on the line or not far from it, the scatter chart provides a fairly accurate method for the separation of fixed and variable.
- Simultaneous Equations** – This uses the straight line equation of  $y = m x + c$  where  $y$  represents total cost,  $m$  is variable cost per unit,  $x$  is the level of output and  $c$  is fixed costs. The total costs at two different volumes are put into these equations which are solved for the values of  $m$  and  $c$ .
- High and Low Method** – The highest and lowest levels of output and costs are taken and the differential is found. This difference arises only due to variable costs. The remaining portion will be



fixed costs. Under this method the variable cost per unit will be computed first and then the fixed cost will be derived. Variable cost per unit is computed by dividing the difference in cost at highest level and lowest level with the difference in volume between highest and lowest level.

- (d) **Least Square Method** – This statistical tool uses straight line equation and finds the line of best fit to solve the equations. Also known as Simple Regression Method. Under this method first the mean of volume and mean of costs are computed. The deviations in volume (x) from the mean and deviation in cost (y) from mean are computed.

### Codification of Overheads

It is always advisable to codify the overhead expenses. Codification helps in easy identification of different items of overheads. There are numerous items of overheads and a code number to each one will facilitate identification of these items easily. Codification can be done by allotting numerical codes or alphabetical codes or a combination of both. Whatever system is followed, it should be remembered that the system is simple for understanding and easy to implement without any unnecessary complications.

Cost Centre codes	Department name
1100	Turning department
1200	Grinding Department
1300	Components manufacturing
1400	Assembly
2100	Maintenance
2200	Quality control
2300	Stores
3100	HR & Administration
3200	Accounts

You may observe the logic in giving the codes. All codes starting with 1 are production departments, all codes starting with 2 are factory related services and all codes starting with 3 are general services. This coding helps collection of costs on functional basis and also to identify an item of expense directly to a department or cost centre.

### Allocation, Apportionment and Reapportionment of Overheads

After the collection, classification and codification of overheads, the next step is allocation and apportionment of overheads into the product units. The following steps are required to complete this process.

#### Departmentalisation

Before the allocation and apportionment process starts, the first step in this direction is 'Departmentalization' of overhead expenses. Departmentalization means creating departments in the firm so that the overhead expenses can be conveniently allocated or apportioned to these departments. For efficient working and to facilitate the process of allocation, apportionment and reapportionment process, an organization is divided into number of departments like, machining, personnel, fabrication, assembling, maintenance, power, tool room, stores, accounts, costing etc and the overheads are collected, allocated or apportioned to these departments. This process is known as 'departmentalization' of overheads which will help in ascertainment of cost of each department and control of expenses.

#### Allocation

CIMA defines Cost Allocation as, 'the charging of discrete, identifiable items of cost to cost centres or cost units'. In simple words *complete distribution of an item of overhead to the departments or*



products on logical or equitable basis is called allocation. Where a cost can be clearly identified with a cost centre or cost unit, then it can be allocated to that particular cost centre or unit. In other words, allocation is the process by which cost items are charged directly to a cost unit or cost centre. For example, electricity charges can be allocated to various departments if separate meters are installed, depreciation of machinery can be allocated to various departments as the machines can be identified, salary of stores clerk can be allocated to stores department, cost of coal used in boiler can be directly allocated to boiler house division. Thus allocation is a direct process of identifying overheads to cost units or cost centres. So the term allocation means allotment of whole item of cost to a particular cost centre or cost object without any division.

### Apportionment

Cost Apportionment is the allotment of proportions of items to cost centers. Wherever possible, the overheads are to be allocated. However, if it is not possible to charge the overheads to a particular cost centre or cost unit, they are to be apportioned to various departments on some suitable basis. This process is called as 'Apportionment' of overheads. The basis for apportionment is normally predetermined and is decided after a careful study of relationships between the base and the other variables within the organisation. The Cost Accountant must ensure that the selected basis is the most logical. A lot of quantitative information has to be collected and constantly updated for the purpose of apportionment. The basis selected should be applied consistently to avoid vitiations. However, there should be a periodical review of the same to revise the basis if needed.

*In simple words, distribution of various items of overheads in proportions to the departments or products on logical or equitable basis is called apportionment.*

A general example of various bases that may be used for the purpose of apportionment is shown below:

Overhead item	Basis
Rent and building	Floor space occupied by each department
General Lighting	No. of light points in each department
Telephones	No. of extensions in a department
Depreciation of factory building	Floor space
Material handling	No. of material requisitions or Value of material issued

The above list is not exhaustive and depending upon peculiarities of the organisation, it could be extended. *This allocation and/or apportionment is called as **primary distribution of overheads**.*

### Distinction between Allocation & Apportionment

Although the purpose of both allocation and apportionment is identical, i.e to identify or allot the costs to the cost centres or cost unit, both are not the same.

Allocation deals with the whole items of cost and apportionment deals with proportion of items of cost.

Allocation is direct process of departmentalization of overheads, where as apportionment needs a suitable basis for sub-division of the cost.

Whether a particular item of expense can be allocated or apportioned does not depends on the nature of expense, but depends on the relation with the cost centre or cost unit to which it is to be charged.

### Principles of Apportionment of Overhead Cost

#### (i) Services Rendered

The principle followed in this method is quite simple. A production department which receives maximum services from service departments should be charged with the largest share of the overheads. Accordingly, the overheads of service departments are charged to the production departments.



(ii) **Ability to Pay**

This method suggests that a large share of service department's overhead costs should be assigned to those producing departments whose product contributes the most to the income of the business firm. However the practical difficulty in this method is that, it is difficult to decide the most paying department and hence difficult to operate.

(iii) **Survey or Analysis Method**

This method is used where a suitable base is difficult to find or it would be too costly to select a method which is considered suitable. For example, the postage cost could be apportioned on a survey of postage used during a year.

(iv) **Efficiency Method**

Under this method, the apportionment of expenses is made on the basis of production targets. If the target is exceeded, the unit cost reduces indicating a more than average efficiency. If the target is not achieved, the unit cost goes up, disclosing there by, the inefficiency of the department.

**Illustration 1**

A factory has 3 production departments (P1, P2, P3) and 2 service departments (S1 & S2). The following overheads & other information are extracted from the books for the month of January 2016.

Expense	Amount (₹)
Rent	6,000
Repair	3,600
Depreciation	2,700
Lighting	600
Supervision	9,000
Fire Insurance for stock	3,000
ESI contribution	900
Power	5,400

Particulars	P1	P2	P3	S1	S2
Area sq ft	400	300	270	150	80
No. of workers	54	48	36	24	18
Wages	18,000	15,000	12,000	9,000	6,000
Value of plant	72,000	54,000	48,000	6,000	
Stock Value	45,000	27,000	18,000		
Horse power of plant	600	400	300	150	50

Allocate or apportion the overheads among the various departments on suitable basis.

**Solution:**

The primary distribution of overheads is as follows:-

Amount (₹)

Expense	Total	Basis	P1	P2	P3	S1	S2
Rent	6,000	Area sq ft	2,000	1,500	1,350	750	400
Repair	3,600	Plant value	1,440	1,080	960	120	-
Depreciation	2,700	Plant value	1,080	810	720	90	-



Lighting	600	Area sq ft	200	150	135	75	40
Supervision	9,000	No of workers	2,700	2,400	1,800	1,200	900
Fire Insurance for stock	3,000	Stock value	1,500	900	600	-	-
ESI contribution	900	Wages	270	225	180	135	90
Power	5,400	Horse power	2,160	1,440	1,080	540	180
Total	31,200		11,350	8,505	6,825	2,910	1,610

### Secondary Distribution of Production Overheads

After the primary distribution as shown above is over, the next step is to re-distribute the service department costs over the production departments. This also needs to be done on some suitable basis, as there may not be a direct linkage between services and production activity. The products actually do not pass through the service departments. So does it mean that the service cost is not a part of cost of production? It very much is the part of production cost! Hence the loading of service costs onto the production departments is necessary. *This process is called secondary distribution of overheads.*

The basis for secondary distribution is dependent on:-

- (i) The nature of service given e.g. it may be maintenance department or stores.
- (ii) Measurement of service based on surveys or analysis
- (iii) General use indices

In the above Illustration No. 1, the costs of S1 (₹2910) and that of S2 (₹1610) will have to be loaded on to the totals of P1, P2 and P3.

Some examples of the bases that can be used to distribute cost of different service departments:

Service department	Basis
Quality	No of inspection done
Maintenance	No of maintenance calls or Material usage for maintenance or Time spent on maintenance
Stores	Indirect material cost or No of issue slips or Quantity of material issued or Value of stock handled
Canteen, welfare	No workers
Internal transport	No. of trucks or trolleys used or Tonne-miles consumed
Payroll office	No. of labour hours
Purchase office	No of purchase orders or Value of material purchased

Again this is not an exhaustive list and could differ from company to company. Many times percentage estimation is also done for such distribution if the service cannot be measured on the basis of any of the above bases. It may be decided that the cost of S1 is to be distributed as P1-40%, P2-25% and P3-35%. Such arbitrary method should be avoided as far as possible.





## Methods of Secondary Distribution

### (a) Direct Distribution Method

This method is based on the assumption that one service department does not give service to other service department/s. Thus between service departments there is no reciprocal service exchange. Hence under this method, service costs are directly loaded on to the production departments. This is simple, but the assumption may not be correct. Can we say that the canteen service is not available to other service departments like labour office or stores or maintenance department? This is incorrect and thus the method should not be used as far as possible.

In the above example consider that if the S1 and S2 costs are to be distributed on assumption of services rendered as S1 to P1 - 40%, P2-30% and P2-10% and the S2 costs are on the basis of 5:3:2, then the table for redistribution of S1 and S2 costs over the production departments P1, P2 and P3 will be as given below.

Department	Total	Basic	P1	P2	P3
Overheads as per primary distribution	26,680		11,350	8,505	6,825
Distribution of S1	2,910	40%;30%;30%	1,164	873	873
Distribution of S2	1,610	5:3:2	805	488	322
Total	31,200		13,319	9,861	8,020

### (b) Step Distribution Method

This method does away with the assumption made under above method, but only partly. It recognises that a service department may render service to the other service department, but does not receive service from it. In above example, S1 may render services to S2 but not vice versa, i.e. S2 may not render service to S1. In such situation, cost of that service department will be distributed first which render services to maximum number of other service departments. After this, the cost of service department serving the next large number of departments is distributed. This process is continued till all service departments are over. Because it is done in steps, it is called as Step Method of Distribution.

### Illustration 2

A manufacturing company has two production departments Fabrication and Assembly and 3 service departments as Stores, Time Office and Maintenance. The departmental overheads summary for the month of March 2016 is given below:

Fabrication	- ₹24000
Assembly	- ₹16000
Stores	- ₹5000
Time office	- ₹4000
Maintenance	- ₹3000

Other information relating to the department was:

Particulars	Production departments		Service departments		
	Fabrication	Assembly	Stores	Time office	Maintenance
No of employees	40	30	20	16	10
No of stores requisition slips	24	20			6
Machine Hours	2400	1600			

Apportion the costs of service departments to the production departments.

**Solution:**

We will have to determine the sequence in which the service departments should be selected for distribution and the bases on which each of them will be distributed. The following logical bases are decided based on the additional information given:

Time office	- No of employees
Stores	- No of stores requisitions
Maintenance	- Machine hours

Also, it can be easily noticed that the time office serves maximum departments (i.e. both production departments, stores & maintenance departments). Stores serve the next larger number of departments (i.e. both production departments and maintenance department).

Maintenance department serves only production departments. Hence the sequence for distribution will be time office, stores and maintenance. This is shown in the following table:

Amount (₹)							
Particulars	Total	Basis	Fabrication	Assembly	Time office	Stores	Maintenance
As per primary distribution	52,000	as given	24,000	16,000	4,000	5,000	3,000
Time office	4,000	no of employees	1,600	1,200	(4,000)	800	400
Stores	5,800	no of req. slips	2,784	2,320		(5,800)	696
Maintenance	4,096	Machine hours	2,458	1,638			(4,096)
		Total	30,842	21,158			

Please notice when we distribute the time office costs first, the charge to stores department is ₹800. This makes the total cost of stores to be distributed as ₹5800 (5000+800). Same is the logic for ₹4096 of Maintenance department.

**(c) Reciprocal Service Method:** This method takes cognizance of the fact that service departments may actually give as well as receive services from and to the other service departments on reciprocal basis. Such inter-departmental exchange of service is given due weight in the distribution of the overheads. There are two methods used for distribution under this logic. One is called Repeated Distribution Method and the other Simultaneous Equation Method.

**(d) Repeated Distribution Method:** This is a continuous distribution of overhead costs over all departments. The decided ratios are used to distribute the costs of service departments to the production and other service departments. This is continued till the figures of service departments become 'nil' or 'negligible'.

**Illustration 3**

The summary as per primary distribution is as follows:

Production departments A- ₹2400; B- ₹2100 & C- ₹1500

Service departments X – ₹700; Y- ₹900

Expenses of service departments are distributed in the ratios of:

X dept. : A- 20%, B- 40%, C- 30% and Y- 10%

Y dept. : A- 40%, B- 20%, C- 20% and X- 20%

Show the distribution of service costs among A, B and C under repeated distribution method.



**Solution:**

Amount (₹)

Particulars	Production departments			Service departments	
	A	B	C	X	Y
As per primary distribution	2400	2100	1500	700	900
Service dept X	140	280	210	(700)	70
Service dept Y	388	194	194	194	(970)
Service dept X	38.8	77.6	58.2	(194)	19.4
Service dept Y	7.76	3.88	3.88	3.88	(19.4)
Service dept X	0.776	1.552	1.164	(3.88)	0.388
Total	2975.336	2657.032	1967.244	0	0.388

It can be noticed that the undistributed balance in service department is very negligible and thus can be ignored for further distribution

**(e) Simultaneous Equations Method:** Under this method, simultaneous equations are formed using the service departments' share with each other. Solving the two equations will give the total cost of service departments after loading the inter- departmental exchange of services. These costs are then distributed among production departments in the given ratios.

In the above Illustration No. 3, service dept X gives 10% of its service to Y and receives 20% of Y's service.

Let 'x' be the total expenses of dept X (its own + share of Y) and

'y' be the total expenses of dept Y (its own + share of X)

This can be expressed as:

'x' = 700 + 20% of 'y' and

'y' = 900 + 10% of 'x'

i.e.  $x = 700 + 0.2y$  and

$y = 900 + 0.1x$

Multiplying both equations by 10, we get

$10x = 7000 + 2y$  i.e.  $10x - 2y = 7000$  and

$10y = 9000 + x$  i.e.  $-x + 10y = 9000$

Now multiplying 2nd equation by 10, and then adding the two equations we get,

$98y = 97000$

Thus  $y = 990$  and  $x = 898$

Based on this we distribute the service department costs over production departments.

**Redistribution Statement**

	Department				
	A	B	C	X	Y
Primary Distribution	2400	2100	1500	700	900
X	180	359	269	(898)	90
Y	396	198	198	198	(990)
<b>Total</b>	<b>2976</b>	<b>2657</b>	<b>1967</b>	—	—

**(f) Trial and Error method**

This method is to be followed when the question of distribution of costs of service cost centres which are interlocked among them arises. In the first stage, gross costs of services of service cost centres are determined. In the second stage cost of service centres are apportioned to production cost centres.

**Limitations of Apportionment**

Whichever method we may use, it still depends on a suitable basis used. The basis will always lead to approximations. If an approximate data is used for analysis, control and decision-making, it may cause erroneous results. Thus one has to be careful in relating the cost data to cost centre or cost unit. The natural relation of most of the indirect costs i.e. overheads is to a time period. In other words, almost all overheads are period costs and hence an attempt to link it to cost unit will always be arbitrary. As such, the traditional methods of allocation and apportionment are often challenged by many in the industry. The techniques like Marginal Costing owe their origin to such limitations of Traditional Costing.

**Capacity of Overhead Rate****Influence of activity level on overhead rate**

In determination of overhead rate, a good deal depends upon the activity level, which is assumed. In other words, capacity consideration influence overhead rate. Overhead rate will be different at different capacity levels. Efficient utilization of capacity is desirable both for society and management. Following capacity concepts merit consideration for overhead rate determination:-

**Theoretical or Maximum Plant Capacity**

Maximum Capacity or the Ideal Capacity is the capacity for which plant is designed to operate. It is only Theoretical Capacity. It does not give allowance for waiting, delays and shut-down. The capacity is significant for designing the plant mechanically. For cost considerations, this capacity is not important. Ideal Capacity is never used to determine overhead rates for its disregard to even necessary interruptions in production process.

**Practical Capacity**

When this capacity is determined, allowance is given for unavoidable interruptions like time lost for repairs, inefficiencies, breakdown, delay in delivery of raw material and supplies, labour shortages and absence, Sunday, holidays, vacation, inventory taking, etc. Thus, Practical Capacity is the maximum Theoretical Capacity with minor unavoidable interruptions. These unavoidable interruptions are based mostly on internal influences and do not consider main external causes like lack of customers orders. The Practical Capacity is determined with reference to nature of industry and circumstances in which a particular factory is situated. Normal unavoidable interruptions account for 15% to 25% of the maximum capacity. The Practical Capacity, thus, ranges between 75% and 85% of maximum capacity after giving allowance for normal unavoidable interruptions.

**Normal Capacity**

Idle capacity due to long-term sales trend only is reduced from Practical Capacity to get Normal Capacity. Calculation of Normal Capacity of a plant presents considerable problems. Normal Capacity is determined for the business as a whole. Then, it is broken down by plants and departments. For Normal Capacity determination, prime considerations are physical capacity and average sales expectancy. It should be noted that average sales expectancy to be considered for this purpose takes into account a period enough to level out cyclical fluctuations. The determination of Normal Capacity helps in: i) the preparation of flexible budgets and computation of predetermined factory overhead rates. ii) the use of Standard Costing, iii) estimating sales price etc., iv) scheduling production, v) inventory valuation, vi) determination of breakeven point, vii) controlling costs.

**Importance of determining Normal Capacity**

The Normal Capacity considerations are important for:

(a) budget preparation;



- (b) determination of overhead rate;
- (c) determination of standard cost, and
- (d) preparation of operation of operational plans.

For determining the Normal Capacity, machinery purchased for future use and outmoded machinery should be excluded for consideration.

### **Capacity based on Sales Expectancy**

Capacity may be based on sales expectancy for the year. The distinction between Normal Capacity and capacity based on sales expectancy should be properly understood. While Normal Capacity considers the long-term trend analysis of sales, which is based on sales of a cycle of years, the capacity based on sales expectancy is based on sales for the year only. When long-term sales trends are determined, cycle of years long enough to even out cyclical fluctuations is considered. Capacity based on sales expectancy is influenced more by general economic conditions and forecast of industry than long term sales trends. The main advantages of determining overhead rate based on sales expectancy are i) Overhead rate is linked with actual sales expectancy, ii) Overhead costs are adequately spread over the production and iii) Overhead rate determined for this purpose is very useful for making decisions like price fixation, etc.

### **Idle Capacity and Excess Capacity**

Practical Capacity is determined after giving allowance to unavoidable interruptions like time lost for repairs, inefficiencies, breakdown and labour shortage, etc., Even this Practical Capacity is not normally fully achieved. Some losses due to idleness of workers and plant facilities to occur even in most carefully administered companies. These losses are not taken into account for determining the Practical Capacity, because for the purpose of determining Practical Capacity only unavoidable interruptions are considered. Thus, the difference between Practical Capacity and Normal Capacity, i.e., the capacity based on long-term sales expectancy is the Idle Capacity. However, if Actual Capacity happens to be different from capacity based on sales expectancy, the idle capacity will represent difference between Practical Capacity and Actual Capacity. Idle Capacity is that part of Practical Capacity which is not utilized due to factors like temporary lack of orders, bottlenecks and machine breakdown, etc. Idle Capacity represents unused productive potential, which fails to be realized due to interruptions that are not unavoidable. Idle capacity is that part of Practical Capacity which is not utilized due to irregular interruptions.

Idle Capacity is different from Excess Capacity. Idle Capacity refers to temporary idleness of available resources due to irregular interruptions. Excess Capacity results either from managerial decision to retain larger production capacity or from unbalanced equipment or machinery within departments. Excess Capacity refers to that portion of Practical Capacity which is available, but no attempt is made for its utilization for strategic or other reasons. If the Excess Capacity results from purchase of assets not required, it will be a prudent policy for company to dispose of the assets which cause Excess Capacity. Alternatively, action should be taken for utilization of resources in the form of Excess Capacity. Excess Capacity also results from imbalance or bottlenecks in certain departments. This situation can be remedied by attempting synchronization in the working of various departments, working overtime, running double shift and temporary off-loading to departments having spare capacity. While overhead rate includes cost of Idle Capacity, Excess Capacity is excluded from overhead rate consideration.

Idle time is distinguished from Idle Capacity and its cost is separated in the accounts. Idle time represents lost time of men and machines arising from lack of business or of material, a breakdown of equipment, faulty supervision or other similar causes whether avoidable or not. Idle Capacity is the difference between Practical Capacity and Actual Capacity and represents the unused production potential.

Idle Capacity costs are represented mostly by the fixed charges of owing and maintaining plant and equipment and of employing services, which are not used to their maximum potential. The principal causes of idle capacity are:



### Production Causes

These causes primarily result from poor organization of operational plan. Following production causes often lead to Idle Capacity:-

- (a) Repetitive machine adjustment - i) Setup and change-over. ii) Repairs and adjustment
- (b) Lack of materials or tools – i) Internal ii) External
- (c) Lack of supervision, inspection and instruction
- (d) Lack of power – i) Internally produced. ii) Externally produced

### Administrative Causes

Sometimes various administrative decisions taken at various level of management result in Idle Capacity. Major administrative causes that lead to Idle Capacity are: a) Excess plant for anticipated expansion, b) Special machines prepared for particular jobs, and c) Strikes / Lockouts.

### Economic Causes

Sometimes demand for the goods is seasonal as in case of wool, ice cream and furs and production cannot be evenly distributed. This is especially true, when there exists danger of deterioration of the product or where carrying charges for stock are too large. Thus, seasonal, cyclical and industrial causes also lead to Idle Capacity.

Various practices are followed in different companies for disposing of Idle Capacity cost. It is often agreed in principle that normal production losses should be absorbed in product costs. Abnormal losses should be treated as non-operating expenses in product costs. Abnormal losses should be treated as non-operating expenses by direct debit to Profit and Loss Account. Certain companies follow the practice of computing idle time costs on their leading products by use of statistical techniques. Cost Accountants should particularly analyse the reasons for idle plant and equipment not used during the period for non-con-controllable causes. The review of practices of different companies reveals that Idle Capacity is a somewhat flexible concept. It is an individual problem which should be considered after taking into account the special situations. For the growth and survival of the organisation, the management is keenly interested to know the idleness, its causes, its cost and its available remedies. Normally different companies follow a bit varying restricted accounting concept of Idle Capacity. In many cases unabsorbed fixed overhead represents losses due to managerial decisions and it becomes a subjective matter to refer it as idle capacity cost. Overhead rates of different capacity levels will be different due to influence of fixed overhead.

### Absorption of Overheads

Once the steps of primary and secondary distribution are carried out, what we get is total indirect costs of production departments. The next step is to assign these totals to the individual product units. A job or a product passes through all or many production departments before it is formed into a finished saleable product. It is necessary to know the cost of each department it passes through per unit. The absorption of overhead enables a Cost Accountant to recover the overhead cost spent on each product department through each unit produced. Overhead absorption is also known as levy or recovery of overheads. How is this done? Suppose in turning department a total of 1200 tubes are turned and the cost of turning department overheads (after secondary distribution) are ₹72000, then can we say the cost of turning per tube is ₹6/-? Most probably yes. This ₹6 per unit is called as *Overhead Absorption Rate*.

***Absorption means 'recording of overheads in Cost Accounts on an estimated basis with the help of a predetermined overhead rate, which is computed at normal or average or maximum capacity'***

In general, the formula for overhead absorption rate is give as:-

Overhead Rate = Amount of Overhead / No of units of the base

Overhead Absorption Rates: For the purpose of absorption of overhead in costs of jobs, processes, or products overhead rates related to suitable factors or bases to be determined. There are several methods in use for determining the overhead rates i.e Actual or Predetermined Overhead Rate, Blanket or Multiple Rates.



### Actual Overhead Rate

Actual Overhead Rate is obtained by dividing the overhead expenses incurred during the accounting period by actual quantum on the base selected. Assuming that the rates are worked out on a monthly basis the formula is:-

Overhead Rate = Actual overhead during the month ÷ Value/Quantity of the base during the month

Absorption of overheads based on actual rates may not be adopted due to the following reasons:-

- (a) Actual overhead rate can be computed only after the accounting period is over.
- (b) The incidence of some of the items of expenses like repairs, overhauling, etc is not uniformly spread over all the accounting periods.
- (c) Actual overhead rates do not provide any basis for cost control.

### Pre-determined Overhead Rate

Predetermined Rate is computed by dividing the budgeted overhead expenses for the accounting period by the budgeted base (quantity, hours, etc)

Overhead Rate = Budgeted overhead expenses for the period / Budgeted Base for the period

### Advantages of Predetermined Overhead Rate

- (a) Enables prompt preparation of cost estimates, quotations and fixation of selling prices.
- (b) Cost data is available to management along with financial data.
- (c) In case of Cost-plus contracts prompt billing is possible through pre-determined recovery rates.
- (d) In concerns having budgetary control system, no extra clerical efforts are required in computing the pre-determined overhead rate.

### Blanket (Single) Overhead Rate

A single overhead rate for the entire factory may be computed for the entire factory. So this is known as factory wide or Blanket Overhead Rate Method.

Blanket Rate = Overhead Cost for the factory / Total Quantum of the base.

Blanket Rate of overheads may be applied suitable in a small size concerns. Blanket Rates are easy to compute. The use of Blanket Rate of overheads gives erroneous and misleading results, where several products passing through number of different departments. With Blanket Rate of overhead, satisfactory level of managerial control is not possible.

### Multiple Rates

This method is most commonly used to determine the multiple overhead rates, i.e separate rates:

- (a) For each producing department;
- (b) For each service department;
- (c) For each Cost Centre; and
- (d) For each product line.

The multiple rates are worked out according to the below formula:

Overhead Rate = Overhead cost allocated & apportioned to each product, dept / Corresponding Base

The number of overhead rates a firm may compute would be fixed taking into consideration of two opposing factors viz clerical costs involved and the degree of accuracy level desired.



### Production Unit Method

Simply put the concept here is to average out the total overheads on total units produced. In a tube manufacturing unit the total overheads are ₹72000 and total tubes processed are 12000. The overhead absorption rate is:  $72000/12000$  i.e. ₹6 per tube. If this rate is based on the budgeted costs and number of units, and if the factory now gets an order for 2500 tube processing, the amount of production overheads to be charged to that order will be  $(2500 * 6)$  i.e. ₹15000/-

### Percentage of Direct Wages

Under this method, overhead for a job is recovered on the basis of a predetermined percentage of direct wages. This method is used when the component of direct wages is higher. If the overhead to be absorbed is ₹120000 and the direct wages are estimated at ₹800000, the predetermined rate will be calculated as  $(120000/800000)$  i.e. 15%. If a job is received where direct wages are estimated at ₹9000/- then the production overheads to be absorbed will be 15% of ₹9000 i.e. ₹1350. This method is useful if the direct labour hours can be standardised and the labour rates do not fluctuate too much. However, this method ignores the contribution made by other resources like machinery. The method also ignores the fact that there may be different types or grades of workers and each may cost differently. It also sidelines the fact that most of the production overheads are time-related.

### Percentage of Direct Material Cost

Here the absorption rate is expressed as a percentage of direct material cost. This method is useful when the proportion of material cost is very high and that of labour cost is comparatively negligible. It is useful if material grades and rates do not fluctuate too much. If production overhead to be absorbed is ₹2000 and the material cost is expected to be ₹4000, then the absorption rate will be  $(2000/4000)$  i.e. Thus 50% of direct material cost. Thus for a job requiring direct material of ₹200, the production overheads to be absorbed will be ₹100 i.e. 50% of ₹200. However, many overhead items bear no relationship with material cost, and also the fact of time dimension of overheads is not taken into account by this method.

### Percentage of Prime Cost

This method combines the benefits of direct wages and direct material cost methods as we know prime cost means direct material plus direct wages plus direct expenses. This method could be used when prime cost constitutes a major proportion of the cost and the rates of material & labour are stable. It is needed that the product made is standard product. If the prime cost is expected to be ₹50000 and the production overheads are estimated at ₹2500, then the absorption rate will be 5% of prime cost. If a job has a prime cost of ₹800, then overhead absorbed on that job will be ₹40/-

### Direct Labour Hour

Under this method, the absorption rate is calculated by dividing the overhead amount by the actual or predetermined direct labour hours. This is extremely useful when the production is labour intensive. This method is superior to the earlier ones, because it takes cognizance of the time factor. If the direct labour hours for a month amount to 10000 and the overheads to be absorbed are ₹5000, then the absorption rate is ₹0.50 per hour (i.e.  $5000/10000$ ). If a job is going to require a labour time of 250 hours, the production overheads to be loaded on the job will be ₹125 (i.e.  $250 * 0.50$ ). The data related to labour hours has to be properly collected or estimated. The labour hour rate may be calculated as a single rate or different for different group of workers.

### Machine Hour Rate

In the days of mechanised production processes, the most relevant rate to be applied is the machine hour rate. This is the rate calculated by dividing the actual or budgeted overhead cost related to a machine or a group of machines by the appropriate number of machine hours. These hours could be actual hours or budgeted hours. When budgeted hours are used they are taken at average capacity at which a factory normally operates. You cannot take full capacity hours as the factory may not operate at that level and then the absorption rate may be unnecessarily fixed at a lower level. The overheads





in a highly mechanised factory are mostly related to the number of hours a machine runs. Hence this is supposed to be the best method for absorbing overhead costs into the cost unit. If a machine normally runs for 2000 hours in a month and monthly overheads to be absorbed are ₹15000, then the machine hour rate will be calculated as  $(15000/2000)$  i.e. ₹7.50 per machine hour. If a job take 75 hours on that machine, then ₹562.50  $(75 \times 7.5)$  will have to be loaded as cost of using the machine for that job.

A machine hour rate may be calculated using only those overheads which are directly related to the machine e.g. power, fuel, repairs, maintenance, depreciation etc. These expenses are totalled and then divided by the hours to compute the rate. This is called as *Ordinary Machine Hour Rate*. Whereas, if costs not related to machine are also included (e.g. supervision, rent, lighting, heating etc.) for the rate calculation, such rate is called as *Composite Machine Hour Rate*. While calculating machine hour rate, the wages paid to machine operators may be added to the total costs. This is because these operators directly work on the machines & thus related to machine operation. At times a factory may have more than one similar machines simultaneously working. In such case, a *group machine hour rate* may be calculated.

### Factors influencing the selection of Overhead Recovery Rate

The particular method or methods selected for application in a company would depend upon the factors mentioned below. Selection of the most equitable method is of paramount importance since a method that is not suitable will distort costs and thus make them useless for control and decision making purpose.

Selection of Overhead Recovery Rates depends on the following factors:-

- (a) Nature of the product and process of manufacture
- (b) Nature of overhead expenses
- (c) Organisational set-up of the undertaking into departments and or cost centers
- (d) Individual requirements with regard to the circumstances prevailing
- (e) Policy of the management
- (f) Accuracy vis-a-vis cost of operating the method. Some of the methods are comparatively more accurate and provide equitable bases for overhead absorption

The main *features* of a satisfactory overhead rate are as follows:-

- (a) Simple, easy to operate, practical and accurate;
- (b) Economic in application;
- (c) Fairly stable so that cost from period to period does not vary;
- (d) Related to time factor as far as practical;
- (e) Departmental rates are preferable to blanket rates;
- (f) Area of activity selected for computation of the rate should be homogeneous cost unit;
- (g) Base for the rate should lay stress on the main production element of the concern.

### Under-absorption and Over-absorption of Overhead

The amount of overhead absorbed in costs is the sum total of the overhead costs allotted to individual cost units by application of the overhead rate. When a predetermined rate worked out on the basis of anticipated or budgeted overhead and base is applied to the actual base, the amount absorbed may not be identical with the amount of overhead expenses incurred if either the actual base or the actual expenses or both deviate from the estimates or the budget.

If the amount absorbed is less than the amount incurred, which may be due to actual expenses exceeding the estimate and / or the output or the hours worked being less than the estimate, the difference denotes under-absorption.



On the other hand if the amount absorbed is more than the expenditure incurred, which may be due to the expense being less than estimate and / or the output or hours worked being more than the estimate, this would indicate over-absorption, which goes to inflate the costs.

Under or over absorption of overhead may arise due to one or the other of the causes given below:-

- (a) Error in estimating overhead expenses
- (b) Error in estimating the level of production, i.e the base
- (c) Major unanticipated changes in the methods of production
- (d) Unforeseen changes in the production capacity
- (e) Seasonal fluctuations in the overhead expenses from period to period
- (f) Overhead rate may be applied to the Normal Capacity which may be less than the full operating capacity of the undertaking

How does one deal with the situation of over or under absorption? There are three ways to handle it:

- (a) *Write-off (in case of under absorption) or write back (in case of over-absorption) to the P & L Account.* This treatment is valid if most of the overhead items are related to time.
- (b) *Carry forward to the next period through a reserve account.* This method is not recommended on the logic that it is inconsistent with Accounting Standards.
- (c) *Use of supplementary rates to adjust the effect to the cost of sales, finished stocks and Work in Process stocks.* This sounds logical as it does not carry forward the unabsorbed or over absorbed overheads to the next accounting period entirely. It aims at splitting the total effect between the cost of sale (which is charged to current year's profits) and stocks (which get carried forward to the next year).

#### Illustration 4

Overhead incurred	₹ 1,50,000
Overhead recovered	₹ 1,00,000
Cost of sales	₹ 10,00,000
Finished goods	₹ 8,00,000
Work in process	₹ 7,00,000

#### Solution:

Here, the overheads under-absorbed are (1,50,000-1,00,000) ₹50,000.

Total of Cost of sales, FG stock & WIP is ₹25,00,000

The supplementary rate will be 50,000/25,00,000 i.e. ₹0.020

This will be distributed as:

₹20,000 to cost of sales (i.e. 10,00,000 x 0.020)

₹16,000 to FG stock (i.e. 8,00,000 x 0.020) and

₹14,000 to WIP (i.e. 7,00,000 x 0.020)



### Reporting of overhead costs

#### Presentation

- Overheads shall be presented as separate cost heads like production, administration and marketing.
- Element wise and behavior wise details of the overheads shall be presented, if material.
- Any under-absorption or over-absorption of overheads shall be presented in the reconciliation statement.

#### Disclosure

- The basis of assignment of overheads to the cost objects.
- Overheads incurred in foreign exchange.
- Overheads relating to resources received from or supplied to related parties
- Any Subsidy / Grant / Incentive or any amount of similar nature received / receivable reduced from overheads.
- Credits / recoveries relating to the overheads.
- Any abnormal cost not forming part of the overheads.
- Any unabsorbed overheads.

#### Illustration 5

In an Engineering Factory, the following particulars have been extracted for the quarter ended 31st December, 2015. Compute the departmental overhead rate for each of the production departments, assuming that overheads are recovered as a percentage of direct wages.

	Production Depts.			Service Depts.	
	A	B	C	X	Y
Direct Wages (₹)	30,000	45,000	60,000	15,000	30,000
Direct Material	15,000	30,000	30,000	22,500	22,500
No. of workers	1,500	2,250	2,250	750	750
Electricity KWH	6,000	4,500	3,000	1,500	1,500
Assets Value	60,000	40,000	30,000	10,000	10,000
No. of Light points	10	16	4	6	4
Area Sq. Yards	150	250	50	50	50

The expenses for the period were:

	Amount (₹)
Power	1,100
Lighting	200
Stores Overhead	800
Welfare of Staff	3,000
Depreciation	30,000
Repairs	6,000
General Overheads	12,000
Rent and Taxes	550

Apportion the expenses of Service Dept. Y according to direct wages and those of Service Department X in the ratio of 5: 3 : 2 to the production departments.

**Solution:**

Statement showing apportionment of overheads and computation of OH rates: Amount (₹)

Particulars	Basis	Total	A	B	C	X	Y
Material	Actual	45,000	—	—	—	22,500	22,500
Wages	Actual	45,000	—	—	—	15,000	30,000
Power	KWH (4:3:2:1:1)	1,100	400	300	200	100	100
Lighting	Light Points (5:8:2:3:2)	200	50	80	20	30	20
Stores overhead	Materials (2:4:4:3:3)	800	100	200	200	150	150
Welfare of staff	No. of workers (2:3:3:1:1)	3,000	600	900	900	300	300
Depreciation	Assets Value (6:4:3:1:1)	30,000	12,000	8,000	6,000	2,000	2,000
Repair	Assets Value (6:4:3:1:1)	6,000	2,400	1,600	1,200	400	400
General Over-heads	Direct Wages (2:3:4:1:2)	12,000	2,000	3,000	4,000	1,000	2,000
Rent & Taxes	Area (3:5:1:1:1)	550	150	250	50	50	50
		<b>1,43,650</b>	<b>17,700</b>	<b>14,330</b>	<b>12,570</b>	<b>41,530</b>	<b>57,520</b>
Costs of 'X'	5:3:2		20,765	12,459	8,306	(41,530)	—
Costs of 'Y'	2:3:4		12,782	19,173	25,565	—	(57,520)
			<b>51,247</b>	<b>45,962</b>	<b>46,441</b>	—	—

Overhead Rate as % on direct wages

$$A = [51,247/30,000] \times 100 = 170.82\%$$

$$B = [45,962/45,000] \times 100 = 102.14\%$$

$$C = [46,441/60,000] \times 100 = 77.40\%$$

**Illustration 6**

The New Enterprises Ltd. has three producing departments A,B and C two service Departments D and E. The following figures are extracted from the records of the Co.

	₹
Rent and Rates	5,000
General Lighting	600
Indirect Wages	1,500
Power	1,500
Depreciation on Machinery	10,000
Sundries	10,000

The following further details are available:



	A	B	C	D	E
Floor Space (Sq.Mts.)	2,000	2,500	3,000	2,000	500
Light Points	10	15	20	10	5
Direct Wages	3,000	2,000	3,000	1,500	500
H.P. of machines	60	30	50	10	--
Working hours	6,226	4,028	4,066	--	--
Value of Material	60,000	80,000	1,00,000	--	--
Value of Assets	1,20,000	1,60,000	2,00,000	10,000	10,000

The expenses of D and E are allocated as follows:

	A	B	C	D	E
D	20%	30%	40%	--	10%
E	40%	20%	30%	10%	--

What is the factory cost of an article if its raw material cost is ₹50, labour cost ₹30 and it passes through Departments A, B and C. For 4, 5 & 3 hours respectively.

**Solution:**

**Statement showing apportionment of overheads to departments**

Amount (₹)

Particulars	Basis	Total	A	B	C	D	E
Rent & Rates	Space (4:5:6:4:1)	5,000	1,000	1,250	1,500	1,000	250
Lighting	Light Points (2:3:4:2:1)	600	100	150	200	100	50
Indirect wages	Direct wages (6:4:6:3:1)	1,500	450	300	450	225	75
Power	Horse Power (6:3:5:1)	1,500	600	300	500	100	--
Depreciation	Value of Asset (12:16:20:1:1)	10,000	2,400	3,200	4,000	200	200
Sundries	Direct wages (6:4:6:3:1)	10,000	3,000	2,000	3,000	1,500	500
Wages	Actual	2,000	--	--	--	1,500	500
		<b>30,600</b>	<b>7,550</b>	<b>7,200</b>	<b>9,650</b>	<b>4,625</b>	<b>1,575</b>

**Repetitive Distribution Method**

Amount (₹)

Particulars	A	B	C	D	E
Totals	7,550	7,200	9,650	4,625	1,575
Cost of D (2:3:4:1)	925	1,387	1,850	(4,625)	463
	8,475	8,587	11,500	--	2,038
Cost of E (4:2:3:1)	815	408	611	204	(2,038)
	9,290	8,995	12,111	204	--
Cost of D (2:3:4:1)	41	61	82	(204)	20
	9,331	9,056	12,193	--	20
Cost of E (4:2:3:1)	8	4	6	2	(20)
	9,339	9,060	12,199	2	--
Cost of D (2:3:4:1)	--	1	1	(2)	--
	<b>9,339</b>	<b>9,061</b>	<b>12,200</b>	<b>--</b>	<b>--</b>
Working Hours	6,226	4,028	4,066		
Rate per hour	1.5	2.25	3.00		

**Computation of Factory Cost of the Article**

Particulars	Amount (₹)
Material	50.00
Labour	30.00
Overheads	
Dept A (4 x 1.5)	6.00
Dept B (5 x 2.25)	11.25
Dept C (3 x 3)	9.00
<b>Factory Cost</b>	<b>106.25</b>

**Simultaneous Equation Method**

Let total cost of Service Department D be ₹ 'd'.

Let total cost of Service Department E be ₹ 'e'.

$$d = 4625 + 10/100 e$$

$$e = 1575 + 10/100 d$$

$$\Rightarrow 100 d = 462500 + 10 e$$

$$\Rightarrow 100 d - 10e = 462500 \quad \rightarrow (1)$$

$$\Rightarrow 100 e = 157500 + 10 d$$

$$\Rightarrow -10 d + 100 e = 157500 \quad \rightarrow (2)$$

$$\text{Equ. (1)} \quad 100 d - 10e = 462500$$

$$\text{Equ. (2)} \times 10 \quad -100 d + 1000e = 1575000$$

$$990e = 2037500$$

$$e = 2037500 / 990$$

$$= 2,058$$

Substituting the value of 'e' in Equation (1), we get

$$\Rightarrow 100 d - 10 (2058) = 462500$$

$$\Rightarrow d = 483080 / 100$$

$$\Rightarrow d = 4831$$

Particulars	A	B	C	D	E
Totals	7,550	7,200	9,650	4,625	1,575
Costs of D (2:3:4:1) (4831)	966	1,450	1,932	(4,831)	483
Costs of E (4:2:3:1) (2,058)	823	412	617	206	(2058)
	9,339	9,062	12,199	--	--



**Illustration 7**

The following information relates to the activities of a production department of factory for a certain period.

	Amount (₹)
Material used	36,000
Direct Wages	30,000
Labour hours	12,000
Hours of Machinery-operation	20,000
Overhead Chargeable to the Dept	25,000

On one order carried out in the department during the period the relevant data were:-

Material used (₹)	6,000
Direct Wages (₹)	4,950
Labour hours worked	1,650 Hrs.
Machine Hours	1,200

Calculate the overheads chargeable to the job by four commonly used methods.

**Solution:**

The four commonly used methods of absorbing or recovering overheads are as follows:

1. % of overheads on material =  $(25,000 / 36,000) \times 100 = 69.44\%$
2. % of overheads on direct wages =  $(25,000 / 30,000) \times 100 = 83.33\%$
3. Overhead rate per labour hour =  $25,000 / 12,000 = 2.083$
4. Machine hour rate method =  $25,000 / 20,000 = 1.25$

The overheads chargeable to job under the above methods is as follows:

1. Material =  $6,000 \times 69.44\% = 4,166.40$
2. Wages =  $4,950 \times 83.33\% = 4,125$
3. Labour hour rate =  $1650 \times 2.083 = ₹ 3,437$
4. Machine hour rate =  $1,200 \times 1.25 = ₹ 1,500$

**Illustration 8**

In a machine department of a factory there are five identical machines. From the particulars given below; prepare the machine hour rate for one of the machines.

Space of the department	10,000 sq.mts.
Space occupied by the machine	2,000 sq.mts.
Cost of the machine (₹)	20,000
Scrap value of the machine (₹)	300
Estimated life of the machine	13 years
Depreciation charged at	$7\frac{1}{2}\%$ p.a
Normal running of the machine	2,000 hours
Power consumed by the machine as shown by the meter	3,000 p.a



Estimated repairs and maintenance throughout the working life of the machine (₹) 5,200 Sundry supplies including oil, waste etc. charged direct to the machine amount to ₹ 600 p.a.

Other expenses of the department are :	Amount (₹)
Rent and Rates	9,000
Lighting (to be apportioned according to workers employed)	400
Supervision	1,250
Other charges	5,000

It is ascertained that the degree of supervision required by the machine is  $\frac{2}{5}$ <sup>th</sup> and  $\frac{3}{5}$ <sup>th</sup> being devoted to other machines.

There are 16 workers in the department of whom 4 attended to the machine and the remaining to the other machines.

**Solution:****Computation of Machine Hour Rate**

Amount (₹)

Particulars		Rate per hr.
<b>Standing Charges</b>		
Rent & Rates	$9000 \times (2000 / 10000) = 1800$	
Lighting	$400 \times (4 / 16) = 100$	
Supervision	$1250 \times (2/5) = 500$	
Other Charges	$5000 \times (1/5) = 1000$	
	= 3400	
Standing charges per hour	$3,400 / 2,000 =$	1.70
<b>Machine Expenses</b>		
Depreciation	$(20000 \times 7.5\%) \div 2,000 = 0.750$	2.75
Power	$(3,000 / 2,000) = 1.500$	
Repairs & Maintenance	$(5200 / 13) \div 2,000 = 0.200$	
Sundry Supplies	$(600 / 2,000) = 0.300$	
<b>Machine Hour Rate =</b>		<b>4.45</b>

**Illustration 9**

From the following particulars given below compute Machine hour rate for a machine.

- Cost ₹ 24,000
- Scrap value ₹ 4,000
- Estimated Working life 40,000 hours
- Estimated cost of repairs and maintenance during the whole life ₹2,000
- Standard charges of the shop for 4 weekly period ₹ 3,000
- Working hours in 4 weekly period 100 hours
- No.of machines in the shop each of which is liable for equal charge are 30 machines.
- Power used per hour 4 units @ 10p. per unit.





**Solution:**

**Computation of Machine Hour Rate**

Amount (₹)

Particulars		Rate per hr.
<b>Standing Charges</b>		
Standing Charges	[3,000 / (100 x 30)]	1.00
<b>Machine Expenses</b>		
Depreciation	[(24,000 – 4,000) / 40,000] = 0.50	
Repairs	[2,000 / 40,000] = 0.05	
Power	[4 x 0.1] = 0.40	0.95
<b>Machine Hour Rate =</b>		<b>1.95</b>

**Illustration 10**

The following particulars relate to a processing machine treating a typical material. You are required to calculate the machine hour rate.

The cost of the machine	₹ 10,000
Estimated life	10 years
Scrap value	₹1,000
Working time (50 weeks of 44 hrs. each)	2,200 hrs.
Machine maintenance per annum	200 hrs
Setting up time estimated @ 5% of total productive time	
Electricity is 16 units per hour @ 10 paise per unit.	
Chemicals required weekly	₹20
Maintenance cost per year	₹1,200

Two attendants control the operations of the machine together with 6 other machines, their combined weekly wages are ₹ 140. Departmental overhead allocated to this machine per annum ₹ 2,000.

**Solution:**

Annual Working hours: 50 weeks X 44 hrs.	2,200
Less : Maintenance time	<u>200</u>
Productive hours	2,000
Less : 5% Setting up time	<u>100</u>
Effective hours	<u>1,900</u>

**Computation of Machine Hour Rate**

Amount (₹)

Particulars		Rate per hr.
<b>Standing Charges</b>		
Chemical Solution	(50 x 20) = 1,000	
Attendants wages	(140 x 50 x 1/7) = 1,000	
Departmental overheads	= <u>2,000</u>	
	= <u>4,000</u>	
Rate per hour	4,000 / 2,200	1.82



<b>Machine Expenses</b>			
Depreciation	$[(10,000 - 1,000)/10] \div 1900 = 0.47$		
Maintenance	$(1,200 / 1,900)$	$= 0.63$	
Power	$(16 \times 0.1)$	$= 1.60$	2.70
<b>Machine Hour Rate =</b>			<b>4.52</b>

**Illustration 11**

Your company uses a historical cost system and applies overheads on the basis of "Predetermined" rates. The following are the figures from the Trial Balance as at 30-9-2015:

	Dr. (₹)	Cr. (₹)
Manufacturing overheads	4,26,544	---
Manufacturing overheads-applied	---	3,65,904
Work-in-progress	1,41,480	---
Finished Goods Stock	2,30,732	---
Cost of Goods Sold	8,40,588	---

Give two methods for the disposal of the under absorbed overheads and show the profit implications of the method.

**Solution:**

	₹
Overheads incurred	= 4,26,544
Overheads absorbed	= <u>3,65,904</u>
Under absorption	= <u>60,640</u>

The following are the 3 methods for disposing off this under absorbed overheads:

1. Transferring to the costing P & L A/c under this method, the profit will decrease by ₹ 60,640.
2. The amount may be disposed off by carrying forward to the next year. In this case, there will be no effect on profit.
3. Applying Supplementary Overhead Rate and further absorbing, which may be shown as follows. Under this method also, the profit will decrease by ₹ 60,640.

$$\begin{aligned} \text{Supplementary OH Rate} &= [60,640 / 12,12,800] \times 100 \\ &= 5\% \end{aligned}$$

Amount (₹)

		Suppl. OH (5%)	Total
Work in Progress	1,41,480	7,074	1,48,554
Finished Goods	2,30,732	11,537	2,42,269
Cost of goods sold	8,40,588	42,029	8,82,617
	12,12,800	60,640	12,73,440



**Illustration 12**

In a factory the expenses of factory are charged on a fixed percentage basis on wages and office overhead expenses are calculated on the basis of percentage of works cost.

	I Order (₹)	II Order (₹)
Material	12,500	18,000
Wages	10,000	14,000
Selling price	44,850	61,880
Percentage of profit on cost	15%	12%

Find the rate of Factory OH and Office OH.

**Solution:**

Let 'X' and 'Y' be the % of Works Overhead on wages and Office Overhead on works cost respectively.

Particulars	Order I	Order II
Material	12,500	18,000
Wages	10,000	14,000
Prime Cost	22,500	32,000
(+) Factory OH's	$(10,000 \times X/100) = 100X$	$(14,000 \times X/100) = 140X$
Works Cost	$22,500 + 100X$	$32,000 + 140X$
(+) Office Overheads [[ $(100 X + 22,500) \times Y/100$ ] [[ $(140 X + 32,000) \times Y/100$ ]	$XY + 225Y$	$1.4XY + 320Y$
Total Cost	$100X + XY + 225Y + 22,500$	$140X + 1.4XY + 320Y + 32,000$
Cost	$44,850 \times (100/115) = 39,000$	$61,880 \times (100/112) = 55,250$

$$100X + XY + 225Y + 22,500 = 39,000$$

$$\Rightarrow 100X + XY + 225Y = 16,500 \quad \rightarrow \text{Equ. (1)}$$

$$140X + 1.4XY + 320Y + 32,000 = 55,250$$

$$\Rightarrow 140X + 1.4XY + 320Y = 23,250 \quad \rightarrow \text{Equ. (2)}$$

$$\text{Equ. (1)} \times 1.4 \Rightarrow 140X + 1.4XY + 315Y = 23,100$$

$$\text{Equ. (2)} \quad \Rightarrow 140X + 1.4XY + 320Y = 23,250$$

$$\begin{array}{r} (-) \quad (-) \quad (-) \quad (-) \\ \hline 5Y = 150 \end{array}$$

Therefore,  $Y = 150/50 = 30$

Substituting the value of Y in Equ. (1), we get X

$$100X + 30X + 225 \times 30 = 16,500 \quad \rightarrow \text{Equ. (1)}$$

$$130X + 6750 = 16,500$$

$$130X = 9,750$$

$$X = 9,750/130 = 75$$

% of Factory OH on wages = 75%

% of Office OH on works cost = 30%

**Illustration 13**

Self-help Ltd. has gensets and produced its own power Data for power costs are as follows :-

	Production Depts.		Service Depts.	
	A	B	X	Y
Horse Power Hours	10,000	20,000	12,000	8,000
Needed at capacity production used during the month of May	8,000	13,000	7,000	6,000

During the month of May costs for generating power amounted to ₹9,300, of this ₹2,500 was considered to be fixed. Dept x renders service to other Depts. in the ratio of 13:6:1, while Y renders service at A & B in the ratio of 31:3. Given that the direct labour hours in Depts. A and B are 1,650 hours and 2,175 hours respectively, find the power cost per labour hour in each of these two departments.

**Solution:**

**Statement Showing apportionment of power cost and computation of cost per hour** Amount (₹)

Particulars	Basis	Total	A	B	X	Y
Fixed Cost	(5:10:6:4)	2,500	500	1,000	600	400
Variable Cost (9,300 – 2,500)	(8:13:7:6)	6,800	1,600	2,600	1,400	1,200
		9,300	2,100	3,600	2,000	1,600
Costs of X [(as it renders to more depts. (3)]	(13:6:1)		1,300	600	(2,000)	100
			3,400	4,200	--	1,700
Costs of Y	(31:3)		1,550	150	--	(1,700)
			4,950	4,350	--	--
Labour Hours			1,650	2,175		
Cost of power per labour hour			3	2		

**Illustration 14**

At Ltd engineering Co. having 25 different types of automatic machines, furnishes you the following data for 2016-17 in respect of machine B:

- Cost of the machine ₹ 50,000  
Life - 10 years Scrap value is nil
- Overhead expenses are:
 

Factory Rent	₹ 50,000 p.a.
Heating and Lighting	₹ 40,000
Supervision	₹ 1,50,000 p.a
Reserve equipment of machine B	₹ 5,000 p.a.
Area of the factory	80,000 sq.ft.
Area occupied by machine B	3,000 sq.ft.
- Wages of operator is ₹24 per day of 8 hours including all fringe benefits. He attends to one machine when it is under set up and two machines while under operation.



4. Estimated production hours                      3,600 p.a.  
     Estimated set up time                            400 hrs. p.a.  
     Power 0.5 per hour

Prepare a schedule of comprehensive machine hour rate and find the cost of the following jobs:

	JOB 1102	JOB 1308
Set up time (Hrs.)	80	40
Operation time (Hrs.)	130	160

**Solution:**

**Computation of machine hour rate when machine is in operation**

Particulars		Amount (₹)
<b>Standing Charges:</b>		
Rent	$50,000 \times 3/80 = 1875$	
Heating & Lighting	$40,000 \times 3/80 = 1500$	
Supervision	$1,50,000 \times 1/25 = 6000$	
Reserve equipment	$= 5000$	
	$= 14375$	
Cost per hour	$14375/4000$	3.59
<b>Machine Expenses:</b>		
Depreciation	$[50,000 \div (10 \times 3600)] = 1.39$	3.39
Wages	$[24/8 \times 1/2] = 1.50$	
Power	$= 0.50$	
<b>Machine Hour Rate</b>		<b>6.98</b>

**Computation of machine hour rate when machine is under setup**

Particulars		Amount (₹)
<b>Standing Charges:</b>		
Rent	$50,000 \times 3/80 = 1875$	
Heating & Lighting	$40,000 \times 3/80 = 1500$	
Supervision	$1,50,000 \times 1/25 = 6000$	
Reserve equipment	$= 5000$	
	$= 14375$	
Cost per hour	$14375/4000$	3.59
<b>Machine Expenses:</b>		
Depreciation	$[50,000 \times (10 \times 3600)] = 1.39$	4.39
Wages	$[24/8] = 3.00$	
Power	$= ---$	
<b>Machine Hour Rate</b>		<b>7.98</b>

**Computation of cost of the jobs**

Particulars	Job 1102	Job 1308
Setup cost		
Job 1102 : 80 x 7.98	638.40	
Job 1308 : 40 x 7.98		319.20
Operation Cost		
Job 1102 : 130 x 6.98	907.40	
Job 1308 : 160 x 6.98		1,116.80
<b>Total Cost of the Job</b>	<b>1,545.80</b>	<b>1,436.00</b>

**Illustration 15**

Ganges Printing Co. has three operating departments:

1. Printing and Binding
2. Lithographing and
3. Engraving.

The company has a job order cost system using a single predetermined expense rate. The management has been made aware of the deficiencies of using such a rate and is now interested in departmentalising factory overhead. A study reveals that:

Department 1 has 3 similar machines representing a large investment and calling for high repairs and depreciation charges.

Department 2 has the workers perform similar tasks and are therefore paid the same hourly wage.

Department 3 however has several classes of workers, each group being paid the same hourly wage.

The estimated factory overhead and production data costs are as follows

	<b>Printing &amp; Binding</b>	<b>Litho- Graphing</b>	<b>Engraving</b>
Factory overhead (₹)	40,000	68,750	1,20,000
Direct labour hours	10,000	20,000	40,000
Direct labour cost (₹)	25,000	55,000	80,000
Machine hours	20,000	NIL	NIL

**Required:**

- 1) An analysis to advice the management regarding the types of rates to be used in these departments.
- 2) A computation of the rates recommended.

**Solution:**

1. It is appropriate to use machine hour rate method of absorbing overheads in Dept 1 because there is large investment in machine and therefore they are predominant.

OH rate per machine hour =  $40,000 / 20,000 = ₹ 2$  per hour.

2. In Dept 2, it is better and appropriate to use labour hour rate of overheads because all the workers are paid at uniform wage rate.

OH rate per labour hour =  $68,750 / 20,000 = ₹ 3.4375$  per hour.

3. In Dept 3, it is better and appropriate to use overhead rate based on certain % of wages because workers are paid at different rates.

OH % on wages =  $(1,20,000 / 80,000) \times 100 = 150\%$

**Illustration 16**

For a department the standard overhead rate is ₹2.50 per hour and the overhead allowances are as follows:

Activity Level (Hours)	Budget overhead Allowance (₹)
3,000	10,000
7,000	18,000
11,000	26,000

**Calculate:**

- Fixed cost
- The standard activity level on the basis of which the standard overhead rate has been worked out.

**Solution:****(a) Fixed Cost**

$$\begin{aligned}
 \text{Variable OH per hour} &= \frac{\text{High level cost} - \text{Low level cost.}}{\text{High level hours} - \text{Low level hours}} \\
 &= \frac{[(26,000 - 10,000) / (11,000 - 3,000)]}{\phantom{=}} \\
 &= ₹ 2 \text{ per hour} \\
 \text{Fixed Cost} &= 10,000 - (3,000 \times 2) = ₹ 4,000
 \end{aligned}$$

**(b) Standard activity level at which the rate has been determined**

$$\begin{aligned}
 \text{Standard activity level at which the rate has been determined} \\
 &= \text{Fixed Cost} / \text{Fixed OH per hour} \\
 &= 4,000 / (2.5 - 2) = 8,000 \text{ hours}
 \end{aligned}$$

**Illustration 17**

In a certain factory three products are made from different materials by similar process. For a typical period production costs are as under:

	Product A	Product B	Product C
Material used	1,600	2,000	800
Direct labour cost	1,200	1,000	400
Overhead (actual)	800	650	350

Overhead is charged to cost of each product at the rate of 25% on prime cost.

Do you see anything wrong in principle in this method of charging overheads? If so, suggest a preferable method.

**Solution:**

Since, different materials are used for producing products, it is advisable, preferable and appropriate to use the method of absorbing overheads based on % of materials instead of % on prime cost which is shown as follows:

	Amount (₹)		
	A	B	C
Materials	1,600	2,000	800
Labour	1,200	1,000	400
Prime Cost	2,800	3,000	1,200
OH @ 25% on prime cost	700	750	300

% of OH on Material Cost:

$$A = [700/1600 \times 100] = 43.75\%$$

$$B = [750/2000 \times 100] = 37.5\%$$

$$C = [300/800 \times 100] = 37.5\%$$

**Illustration 18**

A company produced a simple product in three sizes A, B and C. Prepare a statement showing the selling and distribution expenses apportioned over these three sizes applying the appropriate basis for such apportionment in each case from the particulars indicated:

Express the total of the costs so apportioned to each size as:

- Cost per unit sold (nearest paise)
- A percentage of sales turnover (nearest to two places for decimal).

The Expenses are:

Expenses	Amount	Basis of apportionment
	₹	
Sales salaries	10,000	Direct charge
Sales commission	6,000	Sales turnover
Sales office expenses	2,096	Number of orders
Advt. General	5,000	Sales turnover
Advt. specific	22,000	Direct charge
Packing	3,000	Total volume cu.ft. product sold
Delivery expenditure	4,000	--- do ---
Warehouse expenses	1,000	--- do ---
Expenses credit collection	1,296	Number of orders





Data available relating to the three sizes are as follows :

	TOTAL	SIZE A	SIZE B	SIZE C
1. No. of salesmen, all paid same salary	10	4	5	1
2. Units sold	10,400	3,400	4,000	3,000
3. No. of orders	1,600	700	800	100
4. % of specific advt.	100%	30%	40%	30%
5. Sales turnover	2,00,000	58,000	80,000	62,000
6. Volume of cu.ft. per unit of finished products	--	5	8	17

**Solution:**

**Statement Showing apportionment of selling expenses over the sizes and computation of cost per unit and % on sales:**

Amount (₹)

Particulars	Basis	Total	A	B	C
Sales Salaries	(4:5:1)	10,000	4,000	5,000	1,000
Sales Commission	(29:40:31)	6,000	1,740	2,400	1,860
Sales Office expenses	(7:8:1)	2,096	917	1,048	131
Advt. General	(29:40:31)	5,000	1,450	2,000	1,550
Advt. Specific	(3:4:3)	22,000	6,600	8,800	6,600
Packing	(17:32:51)	3,000	510	960	1,530
Delivery	(17:32:51)	4,000	680	1,280	2,040
Warehouse	(17:32:51)	1,000	170	320	510
Credit collection	(7:8:1)	1,296	567	648	81
		54,392	16,634	22,456	15,302

	Particulars	A	B	C
a)	Cost per unit sold	$(16,634/3,400) \times 100$ = 4.89	$(22,456/4,000) \times 100$ = 5.614	$(15,302/3,000) \times 100$ = 5.10
b)	% on sales	$(16,634/58,000) \times 100$ = 28.67%	$(22,456/80,000) \times 100$ = 28.07	$(15,302/62,000) \times 100$ = 24.68

**Working:**

	A	B	C
Volume of cu. ft. per unit of finished products	5	8	17
Units sold	3,400	4,000	3,000
Total volume of cu. ft.	17,000	32,000	51,000



**Illustration 19**

For a production department of a manufacturing company you are required to :

- (a) Prepare a fixed budget of overhead;
- (b) Prepare a flexible budget of overhead, at 70% and 110% of budget volume;
- (c) Calculate a departmental hourly rate of overhead absorption as per (a) and (b) above.

The budgeted level of activity of the department is 5,000 hours per period and the study of the various items of expenditure reveals the following :

	Amount (₹)	₹ per hour
Indirect wages		0.40
Repairs upto 2,000 hours	100	
for each additional 500 hours		
upto a total of 4,000 hours	35	
Additional from 4,001 to 5,000 hours	60	
Additional above 5,000 hours	70	
Rent and Rates	350	
Power Upto 3,600 hours	0.25	
for hours above 3,600	0.20	
Consumable supplies		0.24
Supervision Upto 2,500 hours		400
Additional for each extra 600 hours		
above 2,500 and upto 4,900 hours		100
Additional above 4,900 hours		150
Depreciation upto 5,000 hours		650
above 5,000 hours and upto 6,500 hours	820	
Cleaning upto 4,000 hours	60	
above 4,000 hours	80	
Heat and lighting from 2,100 hours to 3,500 hours	120	
from 3,500 hours to 5,000 hours	150	
above 5,000 hours	175	

**Solution:**

**Fixed and Flexible Budget showing overhead cost per hour:**

Amount (₹)

Particulars	(3,500)	(5,000)	(5,500)
	70%	100%	110%
Indirect wages (0.4 / hrs.)	1,400	2,000	2,200
Repairs	205	300	370
Rent & Rates	350	350	350
Power	875	1,180	1,280



Consumable Supplies	840	1,200	1,320
Supervision	600	950	950
Depreciation	650	650	820
Cleaning	60	80	80
Heating & Lighting	120	150	175
	5,100	6,860	7,545
OH rate per hour	[5,100/3,500] = 1.457	[6,860/5,000] = 1.372	[7,545/5,500] = 1.372

1. If under absorbed OH is 10% or more of actual OH incurred – Supplementary OH rate is applied. (or)
2. If the amount is considerable, supplementary OH rate applied otherwise we may follow, transferring to P & L A/c or carry forward to next year.

**Working Notes:**

	Amount (₹)		
Repairs	100 + (3x35) = 205	100 + (4x35) + 60 = 300	100 + (4x35) + 60 + 70 = 370
Power	(3500 x 0.25) = 875	(900 + 280) = 1,180	900 + 280 + 100 = 1,280
Supervision	400 + (2 x 100) = 600	400 + (4 x 100) + 150 = 950	400 + (4x100) + 150 = 950

**Illustration 20**

In a manufacturing unit, overhead was recovered at a predetermined rate of ₹25 per man-day. The total factory overhead incurred and the man-days actually worked were ₹ 41,50,000 and 1,50,000 respectively. Out of the 40,000 units produced during a period 30,000 units were sold. There were also 30,000 uncompleted units which may be reckoned at 66.67% complete.

On analysing the reasons, it was found that 40% of the unabsorbed overheads were due to defective planning and the rest were attributable to increase overhead costs.

How would unabsorbed overhead be treated in Cost Accounts?

**Solution:**

	Amount (₹)
Overheads incurred	= 41,50,000
Overheads absorbed (1,50,000 x 25)	= <u>37,50,000</u>
Under absorption	= <u>4,00,000</u>

The under absorption of ₹ 4,00,000 being considerable whether due to defective planning or due to increase in prices, would be disposed off by applying supplementary OH rate in the following manner:

$$\text{Supplementary OH rate} = \frac{4,00,000}{30,000 + 10,000 + (30,000 \times \frac{2}{3})}$$

$$= 4,00,000 / 60,000 = 20/3$$

To be absorbed on cost of goods sold = 30,000 x 20/3 = 2,00,000

To be absorbed on closing stock = 10,000 x 20/3 = 66,667

To be absorbed on Work in progress = 30,000 x 2/3 x 20/3 = 1,33,333

= 4,00,000



## GLOSSARY

**Administrative Overheads:** Administrative overheads are the cost of management, secretarial, accounting and administrative services, which cannot be directly related to the production, marketing, research and development functions of the enterprise. CAS- 3 defines administrative overheads as the cost of all activities relating to general management and administration of an organisation.

**Blanket Overhead Rates:** Blanket overhead rate refers to the computation of one single overhead rate for the whole factory.

$$\text{Blanket overhead rate} = \frac{\text{Overhead Costs for the whole factory}}{\text{Total units of the selected base}} \times 100$$

**Classification of Overheads:** Classification of Overheads is defined by CIMA as the arrangement of items in logical groups having regard to their nature (subjective classification) or the purpose to be fulfilled (objective classification).

**Cost Allocation:** CIMA defines cost allocation as the charging of discrete, identifiable items of cost to cost centres or cost units. It is the complete distribution of an item of overhead to the departments or products on logical or equitable basis. In other words, cost allocation is that part of cost attribution which charges specific cost to a cost centre or cost unit.

**Cost Apportionment:** Cost apportionment is that part of cost attribution which shares costs among two or more cost centres or cost units in proportion to the estimated benefit received. In other words, distribution of various items of overheads in proportion to the departments or products on logical or equitable basis is called cost apportionment.

**Direct Distribution Method:** Under direct distribution method service department costs are apportioned over the production departments only, ignoring the services rendered by one service department to the other.

**Direct Labour Hour Rate:** Direct labour hour rate is the rate calculated by dividing the budgeted or estimated overhead cost attributable to a cost centre by the appropriate number of direct labour hours expected to be incurred at normal capacity.

**Distribution Overheads:** CAS-3 defines distribution overheads as the cost incurred in handling a product from the time it is ready for despatch until it reaches the ultimate consumer.

**Excess Capacity:** Excess capacity refers to that portion of practical capacity which is available, but no attempt is made for its utilisation for strategic or other reasons.

**Fixed Overheads/ Period Costs:** Fixed overheads are the costs that remain fixed or constant irrespective of the volume of output or activity. Fixed costs are considered as period costs e.g. rent, salaries, etc.

**Idle Capacity:** Idle capacity is that part of practical capacity which is not utilised due to factors like temporary lack of orders, bottlenecks and machine breakdown, etc.

**Idle Time:** Idle time is the period of time for which the shop floor is available for production but is not utilised due to shortage of materials, tools, operators, etc. In other words, idle time represents lost time of men and machines arising from lack of business or of material, a breakdown of equipment, faulty supervision or other similar causes whether avoidable or not.

**Indirect Expenses:** Indirect expenses are the expenses which are not charged directly to a product e. g. insurance, rates and taxes etc. CAS-3 defines indirect expenses as the expenses which cannot be directly attributed to a particular cost object.



**Indirect Labour:** Indirect labour costs are the costs which are not charged directly to a product e.g. supervision. CAS-3 defines indirect labour cost as the employee costs which cannot be directly attributed to a particular cost object.

**Indirect Materials:** Indirect materials cost are the material cost which are not charged directly to a product e. g. cotton waste, cleaning materials etc. CAS-3 defines indirect material cost as the cost which cannot be directly attributed to a particular cost object.

**Machine Hour Rate:** Machine hour rate is the rate calculated by dividing the budgeted or estimated overhead or labour and overhead cost attributable to a machine or group of similar machines by the appropriate number of machine hours.

**Manufacturing Overheads:** CAS- 3 defines manufacturing overheads as the indirect expenses incurred for manufacturing product units.

**Maximum Capacity:** Maximum capacity or the ideal capacity is the capacity for which plant is designed to operate. It does not give allowance for waiting, delays and shut-down.

**Overhead Cost:** Overhead Cost is the total cost of indirect material, indirect labour, and indirect expenses. CAS- 3 defines overheads as the cost of indirect materials, indirect employees and indirect expense which are not directly identifiable or allocable to a cost object in an economically feasible manner.

**Reciprocal Service Method:** Reciprocal service method is used when different service departments render services to each other, in addition to rendering services to production departments. In such cases various services departments have to share overheads of each other.

**Research and Development overheads:** Research cost is the cost of searching for new or improved products, new applications of material, or new or improved methods, process, systems or services. Development cost is the cost of the process which begins with the implementation of the decision to use scientific or technical knowledge to produce a new or improved product or to employ a new or improved method, process, system, etc, and ends which the commencement of formal production of that product by that method.

**Selling Overheads:** CAS-3 defines selling overheads as the expenses related to sale of products and include all indirect expenses in sales management for the organisation.

**Semi-Variable Overheads:** Semi-variable overheads are the mixed or hybrid costs partly fixed and partly variable costs, e.g. Telephone charges.

**Under or Over-absorbed Overhead:** Under or over-absorbed overhead is the difference between overhead cost incurred and overhead cost absorbed. If the amount absorbed is less than the amount incurred, which may be due to actual expenses exceeding the estimate and/ or the output or the hours worked being less than the estimate, the difference denotes under-absorption. On the other hand, if the amount absorbed is more than the expenditure incurred, which may be due to the expense being less than estimate and/ or the output or hours worked being more than the estimate, this would indicate over- absorption.

**Variable Overheads:** Variable overheads are the costs which vary totally in direct proportion to the volume of output. These costs fluctuate in total amount but tend to remain constant per unit as production activity changes.



**SELF EXAMINATION QUESTIONS:**

1. What is meant by classification of overheads and why it should be attempted?
2. What do you understand by Semi-Variable Overheads? Explain the various methods of segregating Fixed and Variable Overhead Costs.
3. What are the main sources of overhead expenses? State with examples the procedure for such collection from these sources.
4. Define Cost Allocation and Cost Apportionment. Explain fully the distinction between Cost Allocation and Cost Apportionment.
5. Explain the various basis of apportionment of overheads to departments with illustrations as to the items of expenses.
6. Briefly describe two ways of dealing with the problem of apportioning service department costs among service departments which, in addition to do work for the main operational departments, also serve one another.
7. How are the following items treated in Cost Accounts?
  - a. Defectives due to bad workmanship and bad materials.
  - b. Major repairs of a plant to prolong its useful life.
  - c. Labour amenities.
  - d. ESI contribution
  - e. Fringe benefits to workers.
  - f. After sales service cost
  - g. Losses due to obsolescence.
  - h. Lay off wages paid to workers.
8. As a Cost Accountant explain with reasons how would you treat the following items in Cost Accounts:
  - a. Bonus payable under the Payment of Bonus Act, 1965.
  - b. Bad Debts
  - c. Leave Travel Assistance.
  - d. Night Shift Allowance.
9. Explain the terms "Practical Capacity", "Normal Capacity", "Idle Capacity", and "Imbalanced Capacity". With reference to any industry with which you are familiar, how will you measure the effect of Idle Capacity?
10. What is Absorption? What are the various methods of absorbing overheads in Cost Accounts?
11. What is Under or Over Absorption? What are the causes for Under or Over Absorption?
12. What are the various methods of disposing off under or over absorbed overheads?
13. Write a note on Supplementary Overhead Rate.
14. How to report overhead cost in the cost statement?
15. Explain the nature of administration overheads. How they are apportioned?
16. On what basis would you analyse selling overheads for the purpose of judging the effectiveness of these expenses?



17. "While manufacturing overheads are part of costs, selling overheads are result of policy". Comment.
18. "Management's interest in overheads is not in the method of their absorption but in their behaviour under various conditions of production" As a CMA please throw light on the above statement.
19. Distinguish between cost allocation and cost absorption.
20. Discuss the methods of re-apportionment of service department expenses over the production departments.

### PRACTICE PROBLEMS

21. The 'Prabhat Ltd.' is divided into two production cost centers A and B, and two service cost centers X and Y. The following is the summary of overhead costs for a particular period. Works Manager's Salary ₹4,000; Power ₹21,000; Contribution to PF ₹9,000; Rent ₹6,000; Plant Maintenance ₹4,000. Canteen expenditure ₹12,000; Depreciation of Plant and Machinery ₹ 20,000.

The following information is made available from the various departments.

	DEPT. A	DEPT. B	DEPT. X	DEPT. Y
No. of Employees	16	8	4	4
Area Sq. Ft.	2,000	3,000	500	500
Value of Plant (₹)	75,000	1,00,000	25,000	—
Wages (₹)	40,000	20,000	10,000	5,000
Horse Power	3	3	1	—

Apportion the costs to the various departments on the most equitable basis.

**[Ans: A : ₹ 32,800; B : ₹ 30,400; X : ₹ 9,700; Y : ₹ 3,100]**

22. In a factory there 5 machines, you are required to calculate Machine hour rate from the following data.

Space of the Departments	8,000 Sq.ft.
Cost of machine (₹)	20,000
Space occupied by each machine	1,600 Sq.ft.
Power consumed as indicated by meter is ₹3,000 p.a. for this machine.	
Depreciation	7 ½ % p.a
Estimated life 10 years (working hours 2,000 p.a)	
Estimated Repairs p.a. for this machine ₹ 520	
Rent & Rates	9,000+
Lighting 750+ for all machines	
Supervision	1,500
Other charges	4,000+

2/5 of the supervision is for this machine. There are three mechanics drawing ₹ 50, ₹60, ₹70 p.m respectively.

**[Ans: Machine hour rate ₹ 4.401]**



23. You are required to calculate the machine hour rate from the following particulars.
- Cost of the machine ₹10,000/- its estimated working life is 10 years and the estimated scrap value at the end of its life is ₹ 1,000. The estimated working time per year (50 weeks of 40 hours each) is 2,000 hours.
  - Electricity used by the machine is 16 units per hour at the cost of ₹0.10 per unit.
  - The machine requires a chemical solution which is replaced at the end of each week at cost of ₹20/- each time.
  - The estimated cost of maintenance per year is ₹1,200.
  - Two attendants control the operation of the machine together with five other identical machines their combined week wages amount to ₹120.
  - Departmental and General works overheads allocated to the machine for the year were ₹2,000.
- [Ans: Machine hour rate : ₹ 4.65]**

24. XYZ manufactures household pumps which pass through three departments viz. Foundry, Machine Shop and Assembling.

The manufacturing expenses are as follows:

	Foundry	Machine	Assembling	Total
	₹	₹	₹	₹
Direct wages	10,000	50,000	10,000	70,000
Works Overhead	5,000	90,000	10,000	1,05,000

The factory cost of manufacturing a type of 'C' pump was prepared by the company as follows:

	₹
Material	16
Wages: Foundry	2
Machine Shop	4
Assembling	2
	8
Works Overhead:	
150% of Direct Wages	12
	36

It seems that there is some fallacy. Try to correct it.

**[Ans: Correct Factory cost ₹ 34.20]**

25. The following are the maintenance costs incurred in a machine shop for six months with corresponding machine hours.

MONTH	MACHINE HOURS	MAINTENANCE COSTS (₹)
January	2,000	300
February	2,200	320
March	1,700	270
April	2,400	340
May	1,800	280
June	1,900	290
	12,000	1,800

Analyse the Machine cost which is semi variable into fixed and variable element.

**[Ans: Variable cost per machine hour = ₹ 0.10; Fixed cost ₹ 100]**





26. From the following data segregate fixed cost and variable costs.

	Level of Activity	
	80	100
Capacity (%)	80	100
Labour Hours	400	500
Maintenance expenses of a plant (₹)	2,600	2,750

[Ans: Variable Cost per hour ₹ 1.5; Fixed Cost ₹ 2,000]

27. In a factory, there are two service departments P and Q and three production departments A, B and C. In April 2015, the departmental expenses were:

Departments	A	B	C	P	Q
₹	6,50,000	6,00,000	5,00,000	1,20,000	1,00,000

The service department expenses are allotted on a percentage basis as follows:

Service Departments	Production Departs.			Service Departs.	
	A	B	C	P	Q
P	30	40	15	-	15
Q	40	30	25	5	-

Prepare a statement showing the distribution of the two service departments' expenses to the three departments by a) Simultaneous Equation Method b) Repeated Distribution Method.

[Ans: Total Cost: A – ₹ 7,35,340; B – ₹ 6,86,045 and C – ₹ 5,48,615]

28. The monthly budget of a department is as under:

	Amount (₹)
Direct material	45,000
Direct wages	60,000
Overheads	90,000
Direct labour hours	15,000
Machine hours	30,000

Find out the overhead recovery rate based on at least five different possible methods of absorption of overheads.

[Ans: Direct Material Cost method 200%; Direct Labour Cost Method 150%; Prime Cost Method 85.71%; Direct Labour Hour Rate Method ₹ 6; Machine Hour Rate Method ₹ 3]

29. The following particulars were extracted from the records of Epsilon Ltd. on 31<sup>st</sup> December:

	Dept. A	Dept. B	Dept. C
	₹	₹	₹
Overhead incurred	2,000	1,500	2,500
Overhead absorbed	2,200	1,400	2,250

The departmental loads during the three months to 31<sup>st</sup> December averaged:



Dept. A	100% of Normal Capacity
Dept. B	75% of Normal Capacity
Dept. C	50% of Normal Capacity

How would you deal with the balances under or over-absorbed? What preliminaries enquiries would you make?

[Ans: Dept. A Over-absorbed ₹ 200  
Dept. B under-absorbed ₹ 100  
Dept. C Under-absorbed ₹ 250]

30. The overhead expenses of a factory are allowed on the machine hour method. You are required to calculate the hourly rate for a certain machine from the following information:

Cost	₹ 58,000
Estimated scrap value	₹ 3,000
Estimated working life	20,000 hours
Estimated cost of maintenance during working life of machine	₹ 12,000
Power used for machine	₹ 1 per hour
Rent, rates etc. per month (10% to be charged for this machine)	₹ 1,500
Normal machine running hours during a month	180 hours
Standing charges other than rent, rates etc. per month	₹ 200

[Ans: ₹ 6.30]

### Multiple Choice Questions

- The allotment of whole items of cost of centres or cost unit is called
  - Cost allocation
  - Cost apportionment
  - Overhead absorption
  - None of the above
- Packing cost is a
  - Production of cost
  - Selling cost
  - Distribution cost
  - It may be any or the above



3. Directors remuneration and expenses form a part of
  - A. Production overhead
  - B. Administration overhead
  - C. Selling overhead
  - D. Distribution overhead
4. Charging to a cost center those overheads that result solely for the existence of that cost Center is known as
  - A. Allocation
  - B. Apportionment
  - C. Absorption
  - D. Allotment
5. Absorption means
  - A. Charging or overheads to cost centers
  - B. Charging or overheads to cost units
  - C. Charging or overheads to cost centers or cost units
6. Which method of absorption of factory overheads do you suggest in a concern which Produces only one uniform time of product
  - A. Percentage of direct wages basis
  - B. Direct labour rate
  - C. Machine hour rate
  - D. A rate per units of output
7. When the amount of under-or-over-absorption is significant, it should be disposed of by
  - A. Transferring to costing profit and loss A/c
  - B. The use of supplementary rates
  - C. Carrying over as a deferred charge to the next accounting year
  - D. None of above
8. When the amount of overhead absorbed is less than the amount of overhead incurred, It is called
  - A. Under- absorption of overhead
  - B. Over-absorption of overhead
  - C. Proper absorption of overhead
9. Warehouse expense is an example of
  - A. Production overhead
  - B. Selling overhead
  - C. Distribution overhead
  - D. None of above



10. Selling and Distribution overhead are absorbed on the basis of
  - A. Rate per unit
  - B. Percentage on works cost
  - C. Percentage on selling price of each unit
  - D. Any of these
  
11. Primary packing cost is a part of
  - A. Direct material cost
  - B. Distribution overheads
  - C. Selling overheads
  - D. Production cost
  - E. None of the above
  
12. Chairman's remuneration and expenses form part of
  - A. Administration overhead
  - B. Production overhead
  - C. Distribution overhead
  - D. Selling overhead
  - E. None of the above
  
13. Normal capacity of a plant refers to the difference between:
  - A. Maximum capacity and practical capacity
  - B. Maximum capacity and actual capacity
  - C. Practical capacity and estimated idle capacity as revealed by long term sales trend
  - D. Practical capacity and normal capacity
  - E. None of the above
  
14. Find out from the following a scientific and accurate method of factory overhead absorption:
  - A. Percentage of prime cost method
  - B. Machine hour rate method
  - C. Percentage of direct material cost method
  - D. Percentage of direct labour cost method
  - E. None of the above

[Ans: A, D, B, A, B, D, B, A, C, D, D, A, C, B]



**State the statement is true or false:**

1. Departments that assist producing Department indirectly are called service departments.
2. Factory overhead cost applied to a job is usually based on a per-determined rate.
3. Variable overhead vary with time.
4. When actual overhead are more than absorbed overheads, it is known as over-absorption.
5. Cash discounts are generally excluded completely from the costs.
6. Cost of indirect materials is apportioned to various departments.
7. A blanket overhead rate is a single overhead rate computed for the entire factory.
8. Under-absorption of overhead means that actual overhead are more than absorbed overhead.
9. The principal based used for applying factory overhead are: units of production, material cost, direct wages, direct labour hours and machine hours.
10. Allocation, for overhead implies the identification of overhead cost centres to which they relate.

[Ans: True: 1,2,5,10                      False: 3,4,6,7,8,9]

**Fill in the Blanks:**

1. Overheads are an aggregate of \_\_\_\_\_ and \_\_\_\_\_ and \_\_\_\_\_.
2. Example of after sales services are \_\_\_\_\_ and \_\_\_\_\_.
3. Administration overheads are usually absorbed as a percentage of \_\_\_\_\_.
4. The difference between actual and absorbed factory overhead is called \_\_\_\_\_.
5. The term used for charging of overheads to cost units is known as \_\_\_\_\_.
6. The difference between practical capacity and the capacity based on sales expectancy is known as \_\_\_\_\_.
7. The \_\_\_\_\_ rate is computed by dividing the overheads by the aggregate of the productive hours of direct workers.
8. Under or over absorption of overheads arises only when overheads are absorbed by \_\_\_\_\_.
9. Overhead incurred ₹ 16,000 and overhead absorbed ₹ 15,300. There is under absorption of ₹ \_\_\_\_\_.
10. In Absorption Costing \_\_\_\_\_ cost is added to inventory.

[Ans: Indirect material Indirect Labour and Indirect Expenses, Repair and Maintenance and replacement of Components, Works Cost, under or over absorbed overheads, absorptions, idle capacity, direct labour hour, predetermined overheads rates, ₹ 700, Fixed cost]



Match the following:

	Column "A"		Column "B"
1.	Advertisement	A	Value of goods in transit
2.	Credit and collection	B	Floor area occupied
3.	Warehouse rent	C	A percentage of cash collection
4.	Royalties	D	No. of orders
5.	Bad debts	E	Sales value
6.	Transit insurance	F	Direct allocation

[Ans: E, D, B, F, C,A]



## Study Note - 3

### COST ACCOUNTING STANDARDS

#### This Study Note includes

- 3.1 Preface to Cost Accounting Standards (CASs)
- 3.2 Objectives and Functions of Cost Accounting Standards Board
- 3.3 CAS 1-24 as issued by The Institute of Cost Accountants of India

#### 3.1 PREFACE TO COST ACCOUNTING STANDARDS (CASs)

The council of the Institute of Cost Accountants of India, has constituted 'Cost Accounting Standards Board' (CASB) with the objective of formulating Cost Accounting Standards, after recognizing the need for structured approach to the measurement of cost so as to provide guidance to the user organizations, government bodies, regulators, research agencies, academic institutions and others to achieve uniformity and consistency in classification, measurement and assignment of costs.

The composition of the CASB will be broad based and ensure participation of all interest groups in the standard setting process. The chairman of the CASB will be nominated by the council of the Institute. Apart from six members of the council nominated on the CASB the following will be represented on the CASB :-

- (a) A nominee of the Central Government representing Ministry of Corporate Affairs
- (b) Adviser (Cost), Cost Audit Branch, Ministry of Corporate Affairs, Government of India
- (c) A nominee of the Central Government representing the Central Board of Indirect Taxes and Customs, Government of India
- (d) A nominee of the Central Government representing the Central Board of Direct Taxes
- (e) Two members of the institute representing leading companies
- (f) Four nominees from regulators i.e. CAG, RBI, SEBI, IRDA, TRAI...etc.
- (g) Two nominees from professional institutions i.e. ICAI and ICSI
- (h) Three nominees of industry associations viz ASSOCHAM, CII, FICCI....etc.
- (i) Two nominees from academic institutions like IIM, MDI, Universities...etc.
- (j) Four eminent practicing members of the institute
- (k) President is authorized to include a maximum of two eminent persons having knowledge and expertise in the Cost and Management Accounting / Accounting Standards not falling under the categories as defined in the constitution.

**3.2 OBJECTIVES AND FUNCTIONS OF THE COST ACCOUNTING STANDARDS BOARD**

The objectives of the CASB are to develop high quality Cost Accounting Standards to enable the management to take informed decisions and to enable regulators to function more effectively by integrating, harmonizing and standardizing Cost Accounting Principles and Practices.

The following will be the functions of the CASB :-

- (a) To issue the framework for the Cost Accounting Standards
- (b) To equip the Cost & Management Accounting professionals with better guide lines on cost Accounting Principles
- (c) To assists the members in preparation of uniform cost statements under various statutes
- (d) To provide from time to time interpretations on Cost Accounting Standards
- (e) To issue application guidance relating to particular standard
- (f) To propagate the Cost Accounting Standards and to persuade the users to adopt them in the preparation and presentation of general purpose Cost Statement
- (g) To persuade the government and appropriate authorities to enforce Cost Accounting Standards, to facilitate the adoption thereof, by industry and corporate entities in order to achieve the desired objectives of standardization of Cost Accounting Practices
- (h) To educate the users about the utility and the need for compliance of Cost Accounting Standards

Overview of Cost Accounting Standards issued till date are as follows:

CAS No	Title	Objective
CAS 1	Classification of Cost	For preparation of Cost Statements.
CAS 2	Capacity Determination	To bring uniformity and consistency in the principles and methods of determination of capacity with reasonable accuracy
CAS 3	Production and Operation Overheads	To bring uniformity and consistency in the principles and methods of determining the Production or Operation Overheads with reasonable accuracy
CAS 4	Cost of Production for Captive consumption	To determine the assessable value of excisable goods used for captive consumption
CAS 5	Average (Equalized) Cost of Transportation	To determine averaged / equalized transportation cost
CAS 6	Material Cost	To bring uniformity and consistency in the principles and methods of determining the Material Cost with reasonable accuracy in an economically feasible manner
CAS 7	Employee Cost	To bring uniformity and consistency in the principles and methods of determining the Employee Cost with reasonable accuracy
CAS 8	Cost of Utilities	To bring uniformity and consistency in the principles and methods of determining the Cost of Utilities with reasonable accuracy
CAS 9	Packing Material Cost	To bring uniformity and consistency in the principles and methods of determining the Packing Material Cost with reasonable accuracy





CAS 10	Direct Expenses	To bring uniformity and consistency in the principles and methods of determining the Direct Expenses with reasonable accuracy
CAS 11	Administrative Overheads	To bring uniformity and consistency in the principles and methods of determining the Administrative Overheads with reasonable accuracy
CAS 12	Repairs and Maintenance Cost	To bring uniformity and consistency in the principles and methods of determining the Repairs and Maintenance Cost with reasonable accuracy
CAS 13	Cost of Service Cost Centre	To bring uniformity and consistency in the principles and methods of determining the Cost of Service Cost Centre with reasonable accuracy
CAS 14	Pollution Control Cost	To bring uniformity and consistency in the principles and methods of determining the Pollution Control Costs with reasonable accuracy
CAS 15	Selling and Distribution overheads	To bring uniformity and consistency in the principles and methods of determining the selling and Distribution over-heads with reasonable accuracy
CAS 16	Depreciation and Amortisation	To bring uniformity and consistency in the principles and methods of determining the Depreciation and Amortisation with reasonable accuracy
CAS 17	Interest and Financing Charges.	To bring uniformity and consistency in the principles, methods of determining and assigning the Interest and Financing Charges with reasonable accuracy
CAS 18	Research and Development Costs	To bring uniformity and consistency in the principles and methods of determining the Research, and Development Costs with reasonable accuracy and presentation of the same.
CAS 19	Joint Costs	To bring uniformity and consistency in the principles and methods of determining the Joint Costs.
CAS 20	Cost Accounting Standard on Royalty and Technical Know- How Fee	To bring uniformity and consistency in the principles and methods of determining the amount of Royalty and Technical Know-how Fee with reasonable accuracy
CAS 21	Cost Accounting Standard on Quality Control	To bring uniformity, consistency in the principles, methods of determining and assigning Quality Control cost with reasonable accuracy
CAS 22	Cost Accounting Standard on Manufacturing Cost	To bring uniformity and consistency in the principles and methods of determining the Manufacturing Cost of excisable goods
CAS 23	Cost Accounting Standard on Overburden Removal Cost	To bring uniformity and consistency in the principles and methods of determining and assigning Overburden Removal Cost including those requiring attestation
CAS 24	Cost Accounting Standard on Treatment of Revenue in Cost Statements	To bring uniformity and consistency in the principles and methods for treatment of revenue in cost statements with reasonable accuracy

\*Limited Revision 2017 [CAS 6, 7, 8, 9, 10, 11, 12, 13, 14, 16, 17, 20, 21, 22, 23 & 24]

Each of the Cost Accounting standards has been explained in brief as follows



### 3.3 CAS 1-24 as issued by The Institute of Cost Accountants of India

#### **CAS – 1 COST ACCOUNTING STANDARD ON “CLASSIFICATION OF COST”**

This standard deals with the principles of Classification of Cost for determining the cost of a product or service.

##### **Objective**

The objective of this standard is to bring uniformity and consistency in the principles of Classification of Cost for disclosure and presentation in the cost statements of a product or service.

##### **Scope**

This standard shall be applied to cost statements, which require classification, presentation and disclosure of cost including those requiring attestation.

##### **Principles of Classification of Costs**

Costs shall be classified by the process of grouping the components of cost under a common designation on the basis of similarities of nature, attributes or relations. Items grouped together under common heads shall be further classified according to their fundamental differences.

Scheme of classification shall be such that every item of cost is classified.

##### **Classification of Costs**

- (a) By Nature of expenses
- (b) By nature of traceability to a cost object
- (c) By function
- (d) By nature of behaviour
- (e) By nature of production or operation process

#### **CAS – 2 COST ACCOUNTING STANDARD ON CAPACITY DETERMINATION**

This standard deals with the principles and methods of determining the capacity of a facility for producing goods or providing services by an entity. This standard deals with the principles and methods of classification and determination of capacity of an entity for ascertainment of the cost of product or service, and the presentation and disclosure in cost statements.

##### **Objective**

The objective of this standard is to bring uniformity and consistency in the principles and methods of determination of capacity with reasonable accuracy.

##### **Scope**

This standard shall be applied to the cost statements, including those requiring attestation, which require determination of capacity for assignment of overheads.

**Determination of Capacity:** Capacity shall be determined in terms of units of production or services or equivalent machine or man hours.

**Installed capacity:**

Installed capacity is usually determined based on:

- (i) Technical specifications of facility
- (ii) Technical evaluation
- (iii) Capacities of individual or interrelated production or operation Centres
- (iv) Operational constraints or capacity of critical machines or equipment
- (v) Number of shifts or machine hours or man hours

**Normal Capacity:**

Normal capacity is determined after suitable adjustments to the Installed Capacity.

The adjustments may be of the following nature:

- (i) Time lost due to scheduled preventive or planned maintenance
- (ii) Number of shifts or machine hours or man hours
- (iii) Holidays, normal shut down days, normal idle time
- (iv) Normal time lost in batch change over

**CAS-3: COST ACCOUNTING STANDARD ON “PRODUCTION AND OPERATION OVERHEADS”**

This standard deals with the principles and methods of determining the Production or Operation Overheads. This standard deals with the principles and methods of classification, measurement and assignment of Production or Operation Overheads, for determination of the cost of goods produced or services provided and for the presentation and disclosure in cost statements.

**Objectives**

The objective of this standard is to bring uniformity and consistency in the principles and methods of determining the Production or Operation Overheads with reasonable accuracy.

**Scope**

This standard shall be applied to cost statements, which require classification, measurement, assignment, presentation and disclosure of Production or Operation Overheads including those requiring attestation.

**Disclosures**

The cost statements shall disclose the following:

1. The basis of assignment of Production or Operation Overheads to the cost objects
2. Production or Operation Overheads incurred in foreign exchange
3. Production or Operation Overheads relating to resources received from or supplied to related parties
4. Any Subsidy, Grant, Incentive or any amount of similar nature received or receivable reduced from Production or Operation Overheads
5. Credits or recoveries relating to the Production or Operation Overheads
6. Any abnormal cost not forming part of the Production or Operation Overheads
7. Any unabsorbed Production or Operation Overheads

**CAS-4: Cost Accounting Standard on Cost of Production for Captive Consumption**

Cost Accounting Standard 4 (CAS-4) was issued to specify the principles for determination of cost of production for valuation of goods meant for captive consumption, as required under the Central Excise Valuation (Determination of Price of Excisable Goods) Rules 2000. CBEC, vide circular No. 692/8/2003-CX dated 13-2-2003 had clarified that in case of captive consumption, cost calculation should be as per CAS-4 only.

With the introduction of Goods and Services Tax [GST] with effect from July 1, 2017, the concept of 'captive consumption' is no more relevant for computing the tax incidence. However, the concept of cost of production or manufacture is relevant under the GST laws where the value of supply of goods or services or both are determined based on cost.

**Objective**

The objective of this Standard is to bring uniformity and consistency in the principles and methods of determining the cost of production or acquisition or supply of goods or provision of services as required under the provisions of GST Acts/Rules.

**Scope**

This standard should be applied to cost statements which require classification, measurement, assignment, presentation, and disclosure of related costs for determination of the following under the relevant provisions of GST Acts/Rules.

- (i) Determination of cost of production of goods;
- (ii) Determination of cost of acquisition of goods;
- (iii) Determination of cost of supply of goods;
- (iv) Determination of cost of provision/supply of services; and
- (v) Determination of value of supply of goods or services as per open market value or as per goods or services of like kind and quality.

**CAS-5: Cost Accounting Standard on Determination of Average Cost of Transportation**

The Cost Accounting Principles for tracing/identifying an element of cost, its allocation/apportionment to a product or service are well established. Transportation Cost is an important element of cost for procurement of materials for production and for distribution of product for sale. Therefore, Cost Accounting Records should present transportation cost separately from the other cost of inward materials or cost of sales of finished goods. The Finance Act 2003 also specifies the certification requirement of Transportation Cost for claiming deduction while arriving at the assessable value of excisable goods cleared for home consumption/ export. There is a need to standardize the record keeping of expenses relating to transportation and computation of Transportation Cost.

**Objective**

- (a) To bring uniformity in the application of principles and methods used in the determination of averaged/equalized Transportation Cost
- (b) To prescribe the system to be followed for maintenance of records for collection of cost of transportation, its allocation/apportionment to cost centres, locations or products
- (c) To provide transparency in the determination of cost of transportation

**Scope**

This standard should be applied for calculation of cost of transportation required under any statute or regulations or for any other purpose. For example, this standard can be used for :

- (a) Determination of average transportation cost for claiming the deduction for arriving at the assessable value of excisable goods
- (b) Insurance claim valuation
- (c) Working out claim for freight subsidy under Fertilizer Industry Coordination Committee
- (d) Administered price mechanism of freight cost element
- (e) Determination of inward freight costs included or to be included in the cost of purchases attributable to the acquisition
- (f) Computation of freight included in the value of inventory for accounting on inventory or valuation of stock hypothecated with Banks / Financial Institution ...etc.

**CAS-6: Cost Accounting Standard on Material Cost [Limited Revision 2017]**

This standard deals with principles and methods of determining the Material Cost. Material for the purpose of this standard includes raw materials, process materials, additives, manufactured / bought out components, sub-assemblies, accessories, semi finished goods, consumable stores, spares and other indirect materials. This standard does not deal with Packing Materials as a separate standard is being issued on the subject.

This standard deals with the principles and methods of classification, measurement and assignment of Material Cost, for determination of the Cost of product or service, and the presentation and disclosure in cost statements.

**Objective**

The objective of this standard is to bring uniformity and consistency in the principles and methods of determining the Material Cost with reasonable accuracy.

**Scope**

This standard should be applied to Cost Statements which require classification, measurement, assignment, presentation and disclosure of Material Costs including those requiring attestation.

**CAS-7: Cost Accounting Standard on Employee Cost [Limited Revision 2017]**

This standard deals with the principles and methods of determining the Employee Cost. This standard deals with the principles and methods of classification, measurement and assignment of Employee Cost, for determination of the cost of product or service and the presentation and disclosure in Cost Statements.

**Objective**

The objective of this standard is to bring uniformity and consistency in the principles and methods of determining the Employee Cost with reasonable accuracy.

**Scope**

This standard should be applied to cost statements which require classification, measurement, assignment, presentation and disclosure of Employee Cost including those requiring attestation.

**CAS-8: Cost Accounting Standard on Cost of Utilities [Limited Revision 2017]**

This standard deals with the principles and methods of determining the Cost of Utilities. This standard



deals with the principles and methods of classification, measurement and assignment of Cost of Utilities, for determination of the cost of product or service and the presentation and disclosure in Cost Statements.

### **Objective**

The objective of this standard is to bring uniformity and consistency in the principles and methods of determining the Cost of Utilities with reasonable accuracy.

### **Scope**

This standard shall be applied to cost statements which require classification, measurement, assignment, presentation and disclosure of Cost of Utilities including those requiring attestation.

For determining the cost of production to arrive at an assessable value of excisable utilities used for captive consumption, Cost Accounting Standard 4 on Cost of Production for Captive Consumption (CAS 4) shall apply. This standard shall not be applicable to the organizations primarily engaged in generation and sale of utilities. This standard does not cover issues related to the ascertainment and treatment of carbon credits, which shall be dealt with in a separate standard.

### **CAS-9: Cost Accounting Standard on Packing Material Cost [Limited Revision 2017]**

This standard deals with the principles and methods of determining the Packing Material Cost. This standard deals with the principles and methods of classification, measurement and assignment of Packing Material Cost, for determination of the cost of product, and the presentation and disclosure in Cost Statements. Packing Materials for the purpose of this standard are classified into primary and secondary packing materials.

### **Objective**

The objective of this standard is to bring uniformity and consistency in the principles and methods of determining the packing material cost with reasonable accuracy.

### **Scope**

This standard should be applied to cost statements, which require classification, measurement, assignment, presentation and disclosure of Packing Material Cost including those requiring attestation.

### **CAS-10: Cost Accounting Standard on Direct Expenses [Limited Revision 2017]**

This standard deals with the principles and methods of determining the Direct Expenses. This standard deals with the principles and methods of classification, measurement and assignment of Direct Expenses, for determination of the cost of product or service, and the presentation and disclosure in Cost Statements.

### **Objectives**

The objective of this standard is to bring uniformity and consistency in the principles and methods of determining the Direct Expenses with reasonable accuracy.

### **Scope**

This standard should be applied to Cost Statements, which require classification, measurement, assignment, presentation and disclosure of Direct Expenses including those requiring attestation.

### **CAS-11: Cost Accounting Standard on Administrative overheads [Limited Revision 2017]**

This standard deals with the principles and methods of determining the Administrative Overheads.

This standard deals with the principles and methods of classification, measurement and assignment of Administrative Overheads, for determination of the cost of product or service, and the presentation and disclosure in Cost Statements.

**Objective**

The objective of this standard is to bring uniformity and consistency in the principles and methods of determining the Administrative Overheads with reasonable accuracy.

**Scope**

The standard should be applied to Cost Statements, which require classification, measurement, assignment, presentation and disclosure of Administrative Overheads including those requiring attestation.

**CAS-12: Cost Accounting Standard on Repairs and Maintenance [Limited Revision 2017]**

This standard deals with the principles and methods of determining the Repairs and Maintenance Cost.

This standard deals with the principles and methods of classification, measurement and assignment of Repairs and Maintenance Cost, for determination of the cost of product or service, and the presentation and disclosure in Cost Statements.

**Objective**

The objective of this standard is to bring uniformity and consistency in the principles and methods of determining the Repairs and Maintenance Cost with reasonable accuracy.

**Scope**

The standard should be applied to Cost Statements, which require classification, measurement, assignment, presentation and disclosure of Repairs and Maintenance Cost including those requiring attestation.

**CAS-13: Cost Accounting Standard on Cost of Service Cost Centre [Limited Revision 2017]**

This standard deals with the principles and methods of determining Cost of Service Cost Centres. This standard covers the service cost centre and excludes utilities and repair & maintenance costs dealt with in CAS - 8 & CAS 12 respectively. This standard deals with the principles and methods of classification, measurement and assignment of Cost of Service Cost Centre, for determination of the cost of product or service, and the presentation and disclosure in Cost Statements.

**Objective**

The objective of this standard is to bring uniformity and consistency in the principles and methods of determining the Cost of Service Cost Centre with reasonable accuracy.

**Scope**

The standard should be applied to the preparation & presentation Cost Statements, which require classification, measurement and assignment, of Cost of Service Cost Centres including those requiring attestation.

**CAS-14: Cost Accounting Standard on Pollution Control Cost [Limited Revision 2017]**

This standard deals with the principles and methods of determining Pollution Control Cost. This standard deals with the principles and methods of classification, measurement and assignment of Pollution Control Costs, for determination of the cost of product or service, and the presentation and disclosure in Cost Statements.

**Objective**

The objective of this standard is to bring uniformity and consistency in the principles and methods of determining the Pollution Control Costs with reasonable accuracy.



### **Scope**

The standard should be applied to Cost Statements, which require classification, measurement, assignment, presentation and disclosure of Pollution Control Costs including those requiring attestation.

### **CAS-15: Cost Accounting Standard on Selling and Distribution Overheads**

This standard deals with the principles and methods of determining the Selling and Distribution Overheads.

This standard deals with the principles and methods of classification, measurement and assignment of Selling and Distribution Overheads, for determination of the cost of sales of product or service, and the presentation and disclosure in cost statements.

### **Objective**

The objective of this standard is to bring uniformity and consistency in the principles and methods of determining the Selling and Distribution Overheads with reasonable accuracy.

### **Scope**

This standard should be applied to cost statements, which require classification, measurement, assignment, presentation and disclosure of Selling and Distribution Overheads including those requiring attestation.

### **CAS -16 : Cost Accounting Standard on Depreciation and Amortisation [Limited Revision 2017]**

This standard deals with the principles and methods of determining Depreciation and Amortisation Cost.

This standard deals with the principles and methods of measurement and assignment of Depreciation and Amortisation for determination of the cost of product or service, and the presentation and disclosure in cost statements.

### **Objective**

The objective of this standard is to bring uniformity and consistency in the principles and methods of determining the Depreciation and Amortisation with reasonable accuracy.

### **Scope**

This standard shall be applied to cost statements which require measurement, assignment, presentation and disclosure of Depreciation and Amortisation, including those requiring attestation.

### **CAS-17 : Cost Accounting Standard on Interest and Financing Charges [Limited Revision 2017]**

This standard deals with the principles and methods of determining Interest and Financing Charges.

This standard deals with the principles and methods of classification, measurement and assignment of Interest and Financing Charges.

### **Objective**

The objective of this standard is to bring uniformity and consistency in the principles ,methods of determining and assigning the Interest and Financing Charges with reasonable accuracy.

### **Scope**

This standard should be applied to cost statements which require classification, measurement, assignment, presentation and disclosure of Interest and Financing Charges including those requiring attestation. This standard does not deal with costs relating to risk management through derivatives.



**CAS -18 : Cost Accounting Standard on Research and Development Costs**

This standard deals with the principles and methods of determining Research and Development Cost. This standard deals with the principles and methods of determining the Research, and Development Costs and their classification, measurement and assignment for determination of the cost of product or service, and the presentation and disclosure in cost statements.

**Objective**

The objective of this standard is to bring uniformity and consistency in the principles and methods of determining the Research, and Development Costs with reasonable accuracy and presentation of the same.

**Scope**

This standard should be applied to cost statements that require classification, measurement, assignment, presentation and disclosure of Research, and Development Costs including those requiring attestation.

**CAS-19 : Cost Accounting Standard on Joint Costs**

This standard deals with the principles and methods of determining Joint Cost.

The standard deals with the principles and methods of measurement and assignment of Joint Costs and the presentation and disclosure in cost statement.

**Objective**

The objective of this standard is to bring uniformity, consistency in the principles, methods of determining and assigning Joint Costs with reasonable accuracy.

**Scope**

The standard shall be applied to cost statements which require classification, measurement, assignment, presentation and disclosure of Joint Costs including those requiring attestation.

**CAS-20 : Cost Accounting Standard on Royalty And Technical Know-How Fee [Limited Revision 2017]**

This standard deals with the principles and methods of determining the amount of Royalty and Technical Know-how Fee.

This standard deals with the principles and methods of classification, measurement and assignment of the amount of Royalty and Technical Know-how Fee, for determination of the cost of product or service, and their presentation and disclosure in cost statements.

**Objective**

The objective of this standard is to bring uniformity and consistency in the principles and methods of determining the amount of Royalty and Technical Know-how Fee with reasonable accuracy.

**Scope**

This standard should be applied to cost statements, which require classification, measurement, assignment, presentation and disclosure of the amount of Royalty and Technical Know-how Fee including those requiring attestation.

**CAS-21 : Cost Accounting Standard on Quality Control [Limited Revision 2017]**

The standard deals with the principles and methods of measurement and assignment of Quality Control cost and the presentation and disclosure in cost statement.

**Objective**

The objective of this standard is to bring uniformity, consistency in the principles, methods of determining and assigning Quality Control cost with reasonable accuracy.



### **Scope**

The standards shall be applied to cost statements which require classification, measurement, assignment, presentation and disclosure of Quality Control cost including those requiring attestation.

### **CAS – 22 : Cost Accounting Standard on Manufacturing Cost [Limited Revision 2017]**

This standard deals with the principles and methods of determining the Manufacturing Cost of excisable goods.

This standard deals with the principles and methods of classification, measurement and assignment for determination of the Manufacturing Cost of excisable goods and the presentation and disclosure in cost statements.

### **Objective**

The objective of this standard is to bring uniformity and consistency in the principles and methods of determining the Manufacturing Cost of excisable goods.

### **Scope**

This standard should be applied to cost statements which require classification, measurement, assignment, presentation and disclosure of Manufacturing Cost of excisable goods.

### **CAS 23 Cost Accounting Standard on Overburden Removal Cost [Limited Revision 2017]**

The standard deals with the principles and methods of measurement and assignment of Overburden Removal Cost and the presentation and disclosure in cost statements.

### **Objective**

The objective of this standard is to bring uniformity, consistency in the principles, methods of determining and assigning Overburden Removal Cost with reasonable accuracy.

### **Scope**

The standard shall be applied to cost statements which require classification, measurement, assignment, presentation and disclosure of Overburden Removal Cost including those requiring attestation.

### **CAS 24 Cost Accounting Standard on Treatment of Revenue in Cost Statements [Limited Revision 2017]**

This standard deals with the principles and methods of classification, measurement, treatment and assignment of revenue and its presentation and disclosure in cost statements.

### **Objective**

The objective of this standard is to bring uniformity and consistency in the principles and methods for treatment of revenue in cost statements with reasonable accuracy.

### **Scope**

This standard shall be applied to cost statements which require classification, measurement, treatment, assignment, presentation and disclosure of revenue including those requiring attestation.



**SELF EXAMINATION QUESTIONS:**

1. What is the basic for cost classification as per CAS-1?
2. List the objective of CAS-4.
3. List the scope of CAS-2
4. Name 3 factors that should be disclosed in the cost statements as per CAS-3.
5. Explain the objective of Cost Accounting Standard Board.
6. Write a short note on Cost Accounting Standards.
7. List the objective of CAS-24
8. List the scope of CAS-23

**Multiple Choice Questions:**

1. CAS 21 stands for  
 A. Capacity Determination    B. Joint Cost    C. Direct Expenses    D. None of these.
2. CAS 13 stands for  
 A. Joint Cost    B. Interest and financing charges    C. Employee Cost    D. Cost of Service cost centre
3. Standard deals with the principles and methods of determining the manufacturing Cost of excisable goods-  
 A. CAS 12    B. CAS 15    C. CAS 22    D. CAS 2
4. Standards deals with determination of averages/ equalized transportation cost-  
 A. CAS 6    B. CAS 22    C. CAS 9    D. CAS 5
5. Standards deals with the principles and methods of determining depreciation and amortization cost-  
 A. CAS 9    B. CAS 12    C. CAS 15    D. CAS 16

[Ans: 1. (D), 2. (D), 3. (C), 4. (D), 5. (D)]

**State whether the following statements are true or false:**

1. CAS 19 stands for Joint Cost.
2. Cost Accounting Standard Board Should have minimum three eminent practicing members of the Institute of Cost Accounts of India.
3. Is issue the fromwork for The Cost Accounting Standard is the function of CASB.
4. CAS 2 stands for classification of cost.
5. The objective of CAS 10 is to bring uniformity and consistency in the period and methods of determining the direct expenses with reasonable accuracy.

[Ans: 1. (True), 2. (False), 3. (True), 4. (False), 5. (True)]



**Fill in the blanks:**

1. CAS 9 stands for \_\_\_\_\_.
2. The \_\_\_\_\_ of the CASB will be nominated by the council of The Institute of Cost Accountants of India.
3. \_\_\_\_\_ nominee from the regulate like CAG, RBI to the CASB Board.
4. CAS \_\_\_\_\_ stands for cost of service cost centre.
5. The function of CASB is to assists the members in preparations of uniform \_\_\_\_\_ under various statue.

[Ans: 1. (packing material cost), 2. (chairman) 3. (four), 4. (13), 5. (cost statement)]

**Match the following:**

	Column 'A'		Column 'B'
1.	Pollution Control Cost	A.	CAS 18
2.	Joint Cost	B.	CAS 2
3.	Capacity Determination	C.	CAS 10
4.	Direct Expenses	D.	CAS 14
5.	Research and Development Cost	E.	CAS 19

[Ans: 1. (D), 2. (E) 3. (B), 4. (C), 5. (A)]



# Study Note - 4

## COST BOOK KEEPING

### This Study Note includes

- 4.1 Cost Accounting Records, Ledgers and Cost Statements
- 4.2 Items excluded from Cost and Normal and Abnormal Items/Cost
- 4.3 Non-Integrated Accounting
- 4.4 Integral Accounts
- 4.5 Reconciliation of Cost Accounting Records with Financial Accounts
- 4.6 Infrastructure, Educational, Healthcare and Port Services

### 4.1 COST ACCOUNTING RECORDS, LEDGERS AND COST STATEMENTS

#### COST STATEMENT

In the preceding sections, we have dealt with the basic concepts of costs and the various elements of costs. We have also seen the different steps followed in determination of cost of a product or rendering a service. Treatment of various costs has been discussed at length. You are by now very well aware that the term cost has wide connotations and would not mean anything in isolation. Costs must be understood if they are to be controlled. Measurement of costs is the first step in the process of control simply because you cannot control unless you measure. Measurement of cost would mean different when applied to different industries.

The cost has to be measured with respect to the cost centers first and then at a broader level with respect to the cost unit. The journey towards the aim of determining cost of a product or service may take various routes. But the logic is same i.e. collect all relevant costs in the process of converting raw material into finished product and accumulate the total costs.

To put in simple words, to generate any product or service, resources are needed called as inputs. These inputs are used in a process of conversion. The end result is the output which could either be a product or a service. The resources consume costs. While determining total cost of resources, the costs of all resources used (directly or indirectly) in the process are accumulated. This requires establishing the relationship between the resource and the product or service.

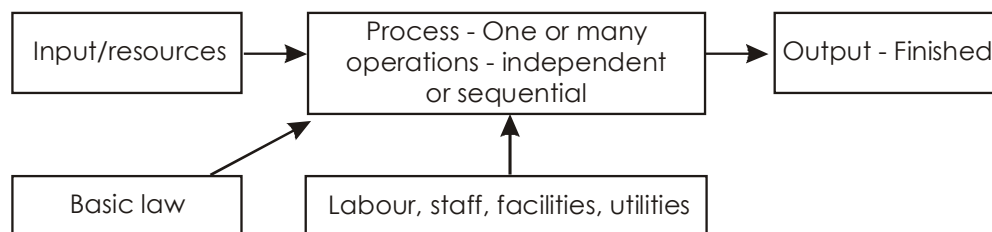



The process of accumulating costs will differ according to the nature of business and the activities carried out. The common way to accumulate costs is to prepare cost sheets.

### **Cost Accumulation**

The logic of Cost Accumulation is to track costs in the same sequence as the resources get used. See the following flow of activities:

- (a) Raw material & other material are purchased and stored
- (b) The material is used up in process of conversion
- (c) People or machines work upon the material while in the process
- (d) The process results into some products that are finished

The cost data needs to be collected along this whole chain that ends when a final product is produced. The cost accumulation is done based on the source documents which are used in booking the costs. Depending upon the type of business, a cost unit is determined for which costs must be accumulated. The departmentalisation of the business organisation is done to suit the production process. For example, in a fruit processing industry, the costs would be accumulated as per different process involved i.e. cutting, pulp formation, blending, purifying and final packing. As the physical flow of material happens from one process to the other, costs are also passed on from one process to the next in line.

As we know all the direct element of cost together make Prime Cost. Sequentially, production overheads are added to get Factory Cost or Works Cost. Then Administration overheads are added to the Factory Cost to get Cost of Production. Once the product is ready for sale, the selling and distribution overheads are added to get Cost of Sales or Cost of Goods Sold. When this is deducted from Sales revenue we get profit or loss.

Process of accumulation of cost comprises of:

- Identification of costs to the cost centers or departments
- Apportionment of service costs to production costs
- Absorption of costs into cost units

### **Cost Collection**

Cost Collection is the process of booking costs against a particular Cost Account code under a particular cost center or directly under a cost unit, as the case may be. Source documents are used to generate the record of the costs incurred or to be incurred. These source documents are properly authorised and numbered. They act as the primary source of entry. In additions to these documents there could be other documents and reports such as allocation sheets, labour utilisation reports, idle time & overtime analysis, scrap reports etc which help in identifying costs. Let us see how the costs are collected.

### **Material costs**

These costs are identified with cost unit with the help of 'stores issue summary'. In case of job costing, there will be job-wise summary prepared on the basis of 'material issue notes'. In case of contracts, the summary will be made contract-wise. At times instead of procuring & storing material, it may be procured and directly used on contract site. 'Purchase Invoice' may be the basis to capture such direct material costs. In case of process industry, the material is issued to different processes. Here, the costs input to a process may be collected based on the cost of materials processed in the previous process. A process-wise summary of material issues is maintained. Some material may get added to a process but may not become part of final product. The cost of such material is apportioned on the output of that



process. The indirect material costs may be gathered on the basis of consumable issues, scrap reports, standard parts list etc. Care should be taken to account for material losses. Normal material losses are to be apportioned to the good units produced, whereas, abnormal losses should be excluded from computation of cost of good units and should be directly taken to P & L Account.

### **Labour Cost**

Salaries and wages summary prepared after the monthly payroll run is the main basis for labour cost collection. The summary shows department-wise break up, so that the Direct Labour Cost of production department is separately known and that for the other indirect departments is also available to be charged as overheads. In case of contracting business, labour force is usually dedicated to various sites. The cost of labour used on different contracts can be found based on wages sheet maintained for each contract site. In addition, the idle time reports, overtime reports are used for booking of the costs of idle time & overtime. In case labourers are common to various jobs or contracts or processes, an estimate of the time that they spend on each of them is made and the costs are allocated accordingly.

### **Expenses**

Accounting entries in cash book or journal proper help to collect the expenses. Direct expenses which are job or contract or process specific may be collected on the basis of vouchers. The indirect expenses are collected and then apportioned in a summarised form using apportionment sheets.

### **Collection of Budgeted costs**

The cost calculation for the selected cost unit could be either of actual cost or budgeted cost. While actual costs are collected on the basis of documents explained above, the budgeted costs are computed using the standard bill of material, and predetermined overhead rates. For budgeted direct material, a bill of material is prepared for each product (including sub-assemblies). This is a quantitative estimate. Based on the estimates a budgeted material price is considered to value the material cost. Estimated labour hours are costed using estimated Labour Hour Rates. Pre-determined overheads are also computed considering the base selected for absorption. Thus an estimate of total cost with full composition may be made.

### **Cost Accountant & Cost Data collection**

The Cost Accountant must play a pivotal role in ensuring that the process of cost data collection is very strong. The cost analysis and reporting will not be useful for managerial decision-making if the data collection process is wrong. Presence of a strong and robust Costing System is needed to ensure comprehensive data collection process. The Costs Account may carry out periodical checks to evaluate the system and also may do the Internal Audit. He can use all his expertise in the process of establishing cost estimates which will help in decision making.

Cost data collected must be reported in proper format to make it more informative and meaningful. As can be understood, the report must serve the purpose for which it was sought. A complete cost sheet may not be always necessary. The production manager may require the cost of production only. The cost report should be able to give this figure separately broken up into all its elements. The sales and marketing cost may be given for each channel of distribution, customers, regions etc in addition to the product-wise break up.

The cost data should be collected in a manner that will make available cost information to all those who are responsible for the costs. A cost sheet should give the figures of each element of cost broken up into direct and indirect and also according to functions like production, administration and selling & distribution. It is therefore logical that the format of the Cost Sheet is derived from the requirements for which it is to be used. Apart from exhibiting the total cost deducted logically, it should highlight other cost also, so that comparison with budget can be made, variances analysed and cost could be controlled to increase profits.

**Cost Sheet Formats & Preparation**

The cost concept itself being subjective, there is no standard format in which the collected costs can be presented. It has to suit the type of business, need of the details, and management's requirement of control over costs. Yet a simple way to show the Total Cost of any cost unit is shown below:

**Specimen Cost Sheet**

Period From .....	Cost Units	
To .....	.....	
Cost Items	Amount (₹)	Amount (₹)
<u>Direct Material</u>		
Opening Stock	xxxxx	
Add: Purchases	xxxxx	
Add: Incidental charges	xxxxx	
Less: Closing Stock	xxxxx	xxxxx
Direct Labour		xxxxx
Direct Expenses		xxxxx
<b>PRIME COST</b>		<b>xxxxxx</b>
Add: Production Overheads	xxxxx	
Add: Opening work in process	xxxxx	
Less: Closing work in process	xxxxx	xxxxx
<b>FACTORY COST OR WORKS COST</b>		<b>xxxxxx</b>
Add: Administrative Overheads		xxxxx
<b>COST OF GOODS MANUFACTURED</b>		<b>xxxxxx</b>
Add: Opening Finished goods stock	xxxxx	
Less: Closing Finished goods stock	xxxxx	xxxxx
<b>COST OF FINISHED GOODS SOLD</b>		<b>xxxxxx</b>
Add: Selling & Distribution overheads		xxxxx
<b>COST OF GOODS SOLD</b>		<b>xxxxxx</b>

You can observe the logical way in which the cost flow has been shown in the above chart. The focus in this specimen is on elements and functions split further into direct and indirect costs with respect to the cost units. Although the formats could be different, the contents of a cost sheet must be understood and interpreted correctly so that one can analyse it for control and decision making. For example if it has to be prepared for a process industry, the format would reflect the portion up to factory cost for each process separately. Then the administration costs will be added together. The cost per unit will be computed for every process separately. The stock for processes subsequent to process one will mean stocks transferred from earlier processes and stocks transferred to the next processes. The objective here is to compute the cost per process. The cost sheet format here could be:





**Specimen Cost Sheet**

Period From ..... To .....	Cost Units .....	
Cost Items	Amount (₹)	Amount (₹)
<u>Direct Material</u>		
Opening Stock	XXXXX	
Add: Purchases	XXXXX	
Add: Incidental charges	XXXXX	
Less: Closing Stock	XXXXX	XXXXX
Direct Labour		XXXXX
Direct Expenses		XXXXX
<b>PRIME COST</b>		<b>XXXXXX</b>
Add: Production overheads	XXXXX	
Add: Opening work in process	XXXXX	
Less: Closing work in process	XXXXX	XXXXX
<b>FACTORY COST OR WORKS COST</b>		<b>XXXXXX</b>
Add: Administrative Overheads		XXXXX
<b>COST OF GOODS MANUFACTURED</b>		<b>XXXXXX</b>
Add: Opening Finished goods stock	XXXXX	
Less: Closing Finished goods stock	XXXXX	XXXXX
<b>COST OF FINISHED GOODS SOLD</b>		<b>XXXXXX</b>
Add: Selling & Distribution overheads		XXXXX
<b>COST OF GOODS SOLD</b>		<b>XXXXXX</b>

Depending on number of processes, the working will be shown up to factory cost. Subsequently, the administration, selling & distribution overheads are added like that shown in the first format. Some process companies may prepare a different cost sheet for each process. When it is available process wise, control of process costs and process losses could be better controlled by the concerned process managers.

**Important Components of Cost Sheet**

- (a) Cost sheet has reference to the job or contract or a batch or production or a service undertaken to be rendered. If the completion of the job at hand relates to more than one accounting period, it is better that separate columns are provided to mention figures for those period. The job or batch reference should also be mentioned on the header.
- (b) If there is an estimate made for the costs, a separate column must be provided for estimated costs against which the actual costs should be plotted to get ready comparison. This will make cost sheets more user-friendly and meaningful.
- (c) In certain cases, material may not form any significant portion of the total cost and as such may be treated as an overhead item. In such cases, the Prime Cost will mainly constitute as labour and other expenses.
- (d) Treatment of raw material stocks should be carefully understood. As the costs are to be linked to the units produced, the material consumption, completion of earlier period's semifinished goods and the finished goods sold needs to be properly computed.

**Raw Material Consumed**                      Opening Stock + Purchases – Closing Stock

One has to go into the depth of this arithmetical formula. Where do we get the figure of purchases from? It is from the suppliers invoices for purchase of stockable material. It also should include all charges incidental to purchase of goods like carriage, insurance, customs duty etc. which is directly associated with the incoming material.



As we know that the stocks are always valued at cost or market price whichever is less. This norm has to be applied to the rates of all the items of material in stock, and then the total valuation of stock is done. The stock ledger records all receipts and issues of the quantity and rate of material items. The valuation of material issues has to be properly done based on correctly chosen method of issue pricing. This summary figure as per the issue column should exactly match with the raw material consumed figure as included in the cost sheet.

The normal losses on account of material shortages must be included in the cost of raw material consumed. Care should be taken to remove the abnormal losses there from.

- (e) Treatment of work in process is another important step. If the format is carefully seen, it will be noticed that the cost of WIP stocks is adjusted specifically after adding Factory Overheads! Why adjusted? And why at that stage only? Please note that Cost Sheet is prepared for a period of time for a cost unit. At the beginning of that period, if the job has been carried forward from the previous period, there may be some partly finished work that is carried forward. At the same time there may be partly finished production at the end of current period. These stocks must be adjusted to reflect the cost consumed during the current period. Further, the work in process is normally valued at Factory Cost. It does not include Administration Overheads as the production of goods is not yet fully complete. Administration costs are absorbed at the stage of finished production. Hence the adjustment of WIP stocks is to be done before adding the Administration Overheads.
- (f) Similarly, the adjustment for the opening and closing stocks of finished goods should be done. This has to be done after the stage of cost of production.
- (g) One could have separate columns for total costs and per unit costs side by side. This will help have a quick glance at the per unit figures. Management at operating level will find this very helpful.

### Illustration 1

Following data is available from the cost records of a company for the month of March 2017:

- (1) Opening stock of job as on 1st March 2017

Job no. A 99: Direct Material ₹80, Direct Wages ₹150 and Factory Overheads ₹200

Job no. A 77: Direct Material ₹420, Direct Wages ₹450 and Factory Overheads ₹400

- (2) Direct material issued during the month of February 2017 was:

Job no A 99 ₹120

Job no A 77 ₹280

Job no A 66 ₹225

Job no A 55 ₹300

- (3) Direct labour details for March 2017 were:

Job no	Hours	Amount (₹)
A 99	400	600
A 77	200	450
A 66	300	675
A 55	100	225

- (4) Factory Overheads are applied to jobs on production according to direct labour hour rate which is ₹2 per hour.
- (5) Factory Overhead incurred in March 2017 were ₹2100.



- (6) Job numbers A 99 & A 77 were completed during the month. They were billed to the customers at a price which included 15% of the price of the job for Selling & Distribution expenses and another 10% of the price for Profit.

Prepare:

- Job cost sheet for job number A 77 and A 99.
- Determine the selling price for the jobs.
- Calculate the value of work in process.

**Solution:**

**Remarks :**

- The Factory Overheads actually incurred are ₹ 2100. This amount to be apportioned on the basis of labour hours. So the rate to be considered as ₹ 2.1 per unit =  $(2100/1000)$  and not ₹2 per unit. If we consider the above mentioned point the calculations for Job Sheets & for the work in progress will change accordingly.
- Work in progress is to be calculated for the incomplete jobs hence job no. A 66 and A 55 should only be included in the calculations of work in progress.

**Job Cost Sheets for the month of March 2017**

**Amount (₹)**

Cost Items	Job A 77	Job A 99
Direct Material issued	280	120
Direct labour spent	450	600
Prime Cost	730	720
Factory Overheads @ ₹ 2.1 per hour	(200×2.1) 420	(400×2.1) 840
Add: Opening WIP (Material + Labour + Overheads)	1,270	430
Factory Cost	2,420	1,990
Add: Selling & Distribution Overheads (Note 1)	484	398
Cost of Sales	2,904	2,388
Profit (Note 1)	323	265
Billing price for the job	3,227	2,653

**Note 1**

S&D and profit are given in indirect way.	480	300
Assume Selling price as 100	320	200
Less: S & D @ 15%	(15)	
Less: Profit @ 10%	(10)	
Balance has to be the Factory Cost	75	
S & D price will be 15/75 of Factory Costs		
Profit will be 10/75 of Factory Cost		

**Computation of Work in Process for March 2017****Amount (₹)**

Items			
Opening balance as on 1 <sup>st</sup> March	Job A 99	430	
	Job A 77	1,270	1,700
Material issued during the month of March	Job A 99	120	
	Job A 77	280	
	Job A 66	225	
	Job A 55	300	925
Direct Labour	Job A 99	600	
	Job A 77	450	
	Job A 66	675	
	Job A 55	225	1,950
Factory Overheads on 1000 hours @ ₹ 2.1			2,100
Factory Cost			6,675
Less: Factory Cost of completed jobs	Job A 77	2,420	
	Job A 99	1,990	4,410
Closing work in process as on 28 <sup>th</sup> March 2017			2,265

Another way to calculate WIP is

Job A 66 and A 55 are in progress & WIP includes only incomplete Jobs.

Direct Material (225+300)	525
Direct Labour (675+225)	900
Factory Overheads [2.1 *(300+100)]	<u>840</u>
Total WIP	<u>2,265</u>

**Illustration 2**

Prepare Cost Sheet for an engineering company which produces standard components in batches of 1000 pieces each. A batch passes through three processes viz. Foundry, Machining & Assembly.

The materials used for a batch number 001 were: Foundry 1300 tonnes @ ₹50 per tonne of which 50 tonnes were sent back to stores.

**Other details**

Process	Direct Labour	Overheads
Foundry	200 Hrs @ ₹ 10	₹ 15 per Labour Hour
Machining	100 Hrs @ ₹ 5	₹ 20 per Labour Hour
Assembly	100 Hrs @ ₹ 15	₹ 10 per Labour Hour

A comparison of actual costs with estimated cost discloses that material and overheads have exceeded the estimates by 20% whereas the estimated labour cost is 10% more than the actual. Show the variances with respect to the estimates

**Solution:****Cost sheets for the Batch number 001****Standard batch size 1000 pieces**

Cost Items	Actual	Estimated	Variance	F/A
Direct material issued (1250 x 50)	62,500	52,083	(10,417)	A
Direct labour spent				
Foundry - 200 x 10	2,000	2,200	200	F
Machining - 100 x 5	500	550	50	F
Assembly - 100 x 15	1,500	1,650	150	F
Prime Cost	66,500	56,483	(10,017)	A
Factory Overheads applied				
Foundry - 200 x 15	3,000	2,500	(500)	A
Machining - 100 x 20	2,000	1,667	(333)	A
Assembly - 100 x 10	1,000	833	(167)	A
Factory Cost	72,500	61,483	(11,017)	A
Cost per unit (Factory Cost/1000)	72.5	61.48	11.02	

**Illustration 3**

An advertising agency has received an enquiry for which you are supposed to submit the quotation. Bill of material prepared by the production department for the job states the following requirement of material:

Paper 10 reams @ ₹1800 per ream

Ink and other printing material                                 ₹5000

Binding material & other consumables                         ₹3000

Some photography is required for the job. The agency does not have a photographer as an employee. It decides to hire one by paying ₹10000 to him. Estimated job card prepared by production department specifies that service of following employees will be required for this job:

Artist (₹12000 per month)   80 hours

Copywriter (₹10000 per month)                                     75 hours

Client servicing (₹9000 per month)                                 30 hours

The primary packing material will be required to the tune of ₹4000. Production Overheads 40% of direct cost, while the S & D Overheads are likely to be 25% on Production Cost. The agency expects a profit of 20% on the quoted price. The agency works 25 days in a month and 6 hours a day.

**Solution:****Quotation for a Printing Job**

Items	Amount (₹)	Amount (₹)
Direct material required:		
Paper 10 x 1800	18,000	
Ink & other printing material	5,000	
Binding material & consumables	3,000	
Primary packing material	4,000	30,000
Direct labour spent		
Artist [12,000/(25 x 6)] x 80	6,400	
Copy writer [10,000 / (25 x 6)] x 75	5,000	
Client Servicing [9,000 / (25 x 6)] x 30	1,800	13,200
Photographer's charges		10,000
Prime Cost		53,200
Factory Overheads applied @ 40% on Direct Cost		21,280
Production Cost		74,480
S & D overheads applied @ 25% on Production Cost		18,620
Total Cost		93,100
Profit (20% on price i.e. 25% on cost)		23,275
Price to be quoted		1,16,375

**Illustration 4**

The following figures were extracted from the Trial Balance of a company as on 31<sup>st</sup> December 2016.

Particulars	Debit Amount (₹)	Credit Amount (₹)
<b>Inventories</b>		
Raw Material	1,40,000	
WIP	2,00,000	
FG	80,000	
Office Appliances	17,400	
Plant and Machinery	4,60,500	
Buildings	2,00,000	
Sales		7,68,000
Sales Returns	14,000	
Material purchased	3,20,000	
Freight on materials	16,000	
Purchase returns		4,800



Direct labour	1,60,000	
Indirect labour	18,000	
Factory supervision	10,000	
Factory repairs & upkeep	14,000	
Heat, light & power	65,000	
Rates & taxes	6,300	
Misc factory expenses	18,700	
Sales commission	33,600	
Sales travelling	11,000	
Sales Promotion	22,500	
Distribution department salaries & wages	18,000	
Office salaries	8,600	
Interest on borrowed funds	2,000	

**Further details are given as follows:**

Closing inventories are Material ₹180000, WIP ₹192000 & FG ₹115000.

Accrued expenses are Direct Labour ₹8000, Indirect Labour ₹1200 & interest ₹2000.

Depreciation should be provided as 5% on Office Appliances, 10% on Machinery and 4% on Buildings.

Heat, light and power are to be distributed in the ratio of 8:1:1 among factory, office and distribution respectively.

Rates & taxes apply as 2/3rd to the factory and 1/3rd to office.

Depreciation on building to be distributed in the ratio of 8:1:1 among factory, office and distribution respectively

Prepare a Cost Sheet showing all important components and also a condensed P & L Account for the year.

**Solution:**

Particulars	Amount (₹)	Amount (₹)
<b>Direct Materials</b>		
Opening stock	1,40,000	
Add: Purchases	3,20,000	
Add: Freight	16,000	
Less: Returns	(4,800)	
Less: Closing Stock	(1,80,000)	2,91,200
Direct Labour	1,60,000	
Add: Accrued	8,000	1,68,000
<b>Prime Cost</b>		<b>4,59,200</b>



<b>Factory Overheads:</b>		
Indirect labour	18,000	
Accrued indirect labour	1,200	
Factory supervision	10,000	
Repairs & upkeep	14,000	
Heat, Light & power	52,000	
Rates & taxes	4,200	
Misc. Factory expenses	18,700	
Depreciation on plant & machinery	46,050	
Depreciation on buildings	6,400	
	1,70,550	
Add: Opening WIP	2,00,000	
Less: Closing WIP	(1,92,000)	1,78,550
Factory Cost		6,37,750
<b>Administration Overheads</b>		
Heat Light & power	6,500	
Rates & taxes	2,100	
Depreciation on buildings	800	
Depreciation on office appliances	870	
Office salaries	8,600	
	18,870	
Add: Opening FG stock	80,000	
Less: Closing FG Stock	(1,15,000)	(16,130)
Cost of Production of saleable units		6,21,620
<b>Selling &amp; Distribution overheads</b>		
Heat & light	6,500	
Depreciation on buildings	800	
Sales commission	33,600	
Sales travelling	11,000	
Sales promotion	22,500	
Distribution department expenses	18,000	92,400
Cost of Sales		7,14,020
<b>Condensed P &amp; L Account for the year ended 31-12-2016</b>		
Sales Income	7,68,000	
Less: Returns	(14,000)	7,54,000
Cost of Sales as above		7,14,020
Interest on borrowings (2,000 + 2,000)		4,000
Net Profit		35,980



**Illustration 5**

PR Ltd. manufactures and sells a typical brand of Tiffin Boxes under its own brand name. The installed capacity of the plant is 1,20,000 units per year distributable evenly over each month of calendar year. The Cost Accountant of the company has informed the following cost structure of the product, which is as follows:

Raw Material ₹ 20 per unit.

Direct Labour ₹ 12 per unit

Direct Expenses ₹ 2 per unit

Variable Overheads ₹ 16 per unit.

Fixed Overhead ₹ 3,00,000.

Semi-variable Overheads are as follows:

₹ 7,500 per month upto 50% capacity & Additional ₹ 2,500 per month for every additional 25% capacity utilization or part thereof.

The plant was operating at 50% capacity during the first seven months of the calendar year 2016, at 100% capacity in the remaining months of the year.

The selling price for the period from 1<sup>st</sup> Jan, 2016 to 31<sup>st</sup> July, 2016 was fixed at ₹ 69 per unit. The firm has been monitoring the profitability and revising the selling price to meet its annual profit target of ₹8,00,000. You are required to suggest the selling price per unit for the period from 1<sup>st</sup> August 2016 to 31<sup>st</sup> December 2016.

Prepare Cost Sheet clearly showing the total and per unit cost and also profit for the period.

1. from 1<sup>st</sup> Jan. to 31<sup>st</sup> July, 2016
2. from 1<sup>st</sup> Aug. to 31<sup>st</sup> Dec, 2016.

**Solution:**

Particulars	Cost Sheet for the period	
	50% capacity utilization (10000 units P.M) – 35000 units, seven months 1 <sup>st</sup> Jan to 31 <sup>st</sup> July, 2016	100% capacity utilization – 50000 units, Five months 1 <sup>st</sup> Aug to 31 <sup>st</sup> Dec, 2016
Raw Materials	7,00,000	10,00,000
Direct Labour	4,20,000	6,00,000
Direct Expenses	70,000	1,00,000
Variable overheads	5,60,000	8,00,000
Fixed Overheads	1,75,000	1,25,000
Semi-Variable Overheads	52,500	62,500
Total Costs	19,77,500	26,87,500
Profit	4,37,500	3,62,500
Sales	24,15,000	30,50,000
Selling Price Per Unit	69.00	61.00
Cost Per Unit	56.50	53.75

**Illustration 6**

X Ltd. Provides you the following figures for the year 2015-16:

Particulars	Amount (₹)
Direct Material	3,20,000
Direct Wages	8,00,000
Production Overheads (25% variable)	4,80,000
Administration Overheads (75% Fixed)	1,60,000
Selling and Distribution Overheads (2/3 <sup>rd</sup> Fixed)	2,40,000
Sales @ ₹ 125 per unit	25,00,000

For the year 2016-17, it is estimated that:

- Output and sales quantity will increase by 20% by incurring additional Advertisement Expenses of ₹ 45,200.
- Material prices will go up 10%.
- Wage Rate will go up by 5% along with, increase in overall direct labour efficiency by 12%.
- Variable Overheads will increase by 5%.
- Fixed Production Overheads will increase by 33 1/3 %

**Required:**

- Calculate the Cost of Sales for the year 2015-2016 and 2016-2017.
- Find out the new selling price for the year 2016-2017.
  - If the same amount of profit is to be earned as in 2015-2016.
  - If the same percentage of profit to sales is to be earned as in 2015-2016.
  - If the existing percentage of profit to sales is to be increased by 25%.
  - If Profit per unit ₹ 10 is to be earned.

**Solution:****(a) Statement showing the Cost of Sales****Amount (₹)**

	Particulars	For 20000 units	For 24000 units
A.	Direct Materials	3,20,000	4,22,400 [₹3,20,000 x 110% x 120%]
B.	Direct wages	8,00,000	9,00,000 [₹ 8,00,000 x (105/100) x (100/112) x 120%]
C.	Prime Cost	11,20,000	13,22,400
D.	Add: Production Overheads		
	Variable Production Overheads	1,20,000 [₹ 4,80,000 x 25%]	1,51,200 [₹1,20,000 x 105% x 120%]
	Fixed Production Overheads	3,60,000 [₹ 4,80,000 x 75%]	4,80,000 [₹ 3,60,000 x 133%]
E.	Works Cost (C + D)	16,00,000	19,53,600

F.	Add: Administration Overheads		
	Variable Admn. Overheads	40,000	50,400 [₹ 40,000 x 105% x 120%]
	Fixed Admn. Overheads	1,20,000	1,20,000
G.	Cost of Goods Produced	17,60,000	21,24,000
H.	Add: Selling and Distribution Overheads		
	Variable Selling & Distribution OHs	80,000	1,00,800 [₹ 80,000 x 105% x 120%]
	Fixed Selling & Distribution OHs	1,60,000	1,60,000
	Additional Advertisement Exp.		45,200
I.	Cost of Sales [G + H]	20,00,000	24,30,000

(b)

(i) New Selling Price = (₹ 24,30,000 + ₹ 5,00,000)/24,000 units = ₹ 122.08

(ii) New Selling Price = (₹ 24,30,000 + 25% or ₹ 24,30,000)/24,000 units = ₹ 126.5625

(iii) New Selling Price = (₹ 24,30,000 + 1/3<sup>rd</sup> or ₹ 24,30,000)/24,000 units = ₹ 135

(iv) New Selling Price = (₹ 24,30,000 + (24,000 x ₹ 10) / 24,000 units = ₹ 111.25

**Illustration 7**

The following are the costing records for the year 2017 of a manufacturer:

Production 10,000 units; Cost of Raw Materials ₹ 2,00,000; Labour Cost ₹ 1,20,000; Factory Overheads ₹ 80,000; Office Overheads ₹ 40,000; Selling Expenses ₹ 10,000, Rate of Profit 25% on the Selling Price.

The manufacturer decided to produce 15,000 units in 2017. It is estimated that the cost of raw materials will increase by 20%, the labour cost will increase by 10%, 50% of the overhead charges are fixed and the other 50% are variable. The selling expenses per unit will be reduced by 20%. The rate of profit will remain the same.

Prepare a Cost Statement for the year 2017 showing the total profit and selling price per unit.

**Solution:**

**Statement of Cost & Profit (Cost Sheet)**  
(Output 10,000 units)

Particulars	Cost per unit	Total Cost
Raw Materials	20	2,00,000
Labour	12	1,20,000
<b>PRIME COST</b>	<b>32</b>	<b>3,20,000</b>
Add: Factory Overhead	8	80,000
<b>WORKS COST</b>	<b>40</b>	<b>4,00,000</b>
Add: Office Overhead	4	40,000
<b>COST OF PRODUCTION</b>	<b>44</b>	<b>4,40,000</b>
Add: Selling Expenses	1	10,000
<b>COST OF SALES</b>	<b>45</b>	<b>4,50,000</b>
Add: Profit (25% on Selling Price or 33.33% on Cost of Sales)	15	1,50,000
<b>SELLING PRICE</b>	<b>60</b>	<b>6,00,000</b>

**Statement of Cost & Profit (Cost Sheet)****(Output 15,000 units)****Amount (₹)**

<b>Particulars</b>	<b>Cost per unit</b>	<b>Total Cost</b>
Raw Materials (₹ 20 x 120% x 15,000)	24.00	3,60,000
Labour (₹ 12 x 110% x 15,000)	13.20	1,98,000
<b>PRIME COST</b>	<b>37.20</b>	<b>5,58,000</b>
Add: Factory Overhead (₹ 80,000 x 50% + ₹ 4 x 15,000)	6.67	1,00,000
<b>WORKS COST</b>	<b>43.87</b>	<b>6,58,000</b>
Add: Office Overhead (₹ 40,000 x 50% + ₹ 2 x 15,000)	3.33	50,000
<b>COST OF PRODUCTION</b>	<b>47.20</b>	<b>7,08,000</b>
Add: Selling Expenses (₹ 1 x 80% x 15,000)	0.80	12,000
<b>COST OF SALES</b>	<b>48.00</b>	<b>7,20,000</b>
Add: Profit (25% on Selling Price or 33.33% on Cost of Sales)	16.00	2,40,000
<b>SELLING PRICE</b>	<b>64.00</b>	<b>9,60,000</b>

**4.2 ITEMS EXCLUDED FROM COST AND NORMAL AND ABNORMAL ITEMS/COST****Items Excluded from Cost Accounts**

There are certain items which are included in financial accounts of a manufacturing concern but shall not to be included in cost accounts since they are not related to cost of production. These items fall into three categories:-

**Appropriation of profits:**

- (i) Appropriation to sinking funds
- (ii) Dividends paid
- (iii) Taxes on income and profits
- (iv) Transfers to general reserves
- (v) Excess provision for depreciation of buildings, plant etc. and for bad debts
- (vi) Amount written off – goodwill, preliminary expenses, underwriting commission, discount on debentures issued; expenses of capital issue etc.
- (vii) Capital expenditures specifically charged to revenue
- (viii) Charitable donation

**Matters of pure finance****(a) Purely financial charges:-**

- (i) Losses on sale of investments, buildings, etc.
- (ii) Expenses on transfer of company's office
- (iii) Interest on bank loan, debentures, mortgages, etc.
- (iv) Damages payable



- (v) Penalties and fines
- (vi) Losses due to scrapping of machinery
- (vii) Remuneration paid to the proprietor in excess of a fair reward for services rendered

**(b) Purely financial incomes:-**

- (i) Interest received on bank deposits
- (ii) Profits made on the sale of investments, fixed assets, etc.
- (iii) Transfer fees received
- (iv) Rent receivable
- (v) Interest, dividends, etc. received on investments.
- (vi) Brokerage received
- (vii) Discount, commission received

**Abnormal gains and losses:-**

- (i) Losses or gains on sale of fixed assets.
- (ii) Loss to business property on account of theft, fire or other natural calamities.

In addition to above abnormal items (gain and losses) may also be excluded from cost accounts. Alternatively, these may be taken to costing profit and loss account.

### 4.3 NON-INTEGRATED ACCOUNTING

Non - Integrated Accounting is a system of accounting under which separate ledgers are maintained for cost and financial accounts by accountants. This system is also referred to as cost ledger accounting system. Under such a system the cost accounts restrict itself to recording only those transactions which relate to the product or service being provided. This leads to the exclusion of certain expenses e.g. interest, bad debts and revenue/income from other than the sale of product or service.

Non-Integrated Accounting System contains fewer accounts when compared with financial accounting because of the exclusion of purchases, expenses and also balance sheet items viz. fixed assets, debtors and creditors. Items of accounts which are excluded are represented by an account called Cost Ledger Control Account. The important ledgers to be maintained under non-integrated accounting system in the cost accounting department are discussed below.

- (a) *Cost Ledger*: Cost ledger is the principal ledger of the cost department in which impersonal accounts are recorded. This ledger is made self-balancing by maintaining therein a control account for each subsidiary ledger.
- (b) *Stores Ledger*: Stores ledger contains an account for each of stores. The entries in each account maintained in this ledger are made from the invoice, goods received note, material requisitions, material received note etc. Accounts in respect of each item of stores show receipt, issue and balance in physical as well as in monetary terms.
- (c) *Work-in-Process Ledger*: Work-in-process ledger contains accounts of unfinished jobs and processes. All material costs, wages and overheads for each job in process are posted to the respective job account in this ledger. The balance in a job account represents total balance of job/work-in-process, as shown by the job account.
- (d) *Finished Goods Ledger*- Finished goods ledger contains an account for each item of finished product manufactured or the completed job. If the finished product is transferred to stores, a credit entry is passed in the work-in-process ledger and a corresponding debit entry is passed in this ledger.

**Principal Books of Accounts**

- (i) *Cost Ledger Control Account*: Cost ledger control account is also known as General Ledger Adjustment Account. This account is made to complete double entry. All items of expenditure are credited to this account. Sales are debited to this account and net profit/loss is transferred to this account. The balance in this account at the end of the particular period represents the net total of all the balances of the impersonal account.
- (ii) *Stores Ledger Control Account*: Stores ledger control account is debited for the purchase of material and credited for issue of materials from stores. The balance in this account indicates the total balance of all the individual stores accounts. Abnormal losses or gains if any, in this account are transferred to Costing Profit & Loss Account. Entries are made on the basis of goods received notes and stores requisitions.
- (iii) *Wages Control Account*: Wages control account is debited with total wages paid (direct and indirect). Direct wages are further transferred to Work-in-Process Control Account and indirect wages to Production Overhead, Administration Overhead or Selling & Distribution Overhead Control Accounts, as the case may be. Wages paid for abnormal idle time are transferred to Costing Profit & Loss Account either directly or through abnormal loss account.
- (iv) *Manufacturing/Production/Works/Factory Overhead Control Account*: Production/factory overhead control account is debited with indirect costs of production such as indirect material, indirect labour, indirect expenses (viz. carriage inward etc.). Overhead recovered is credited to this account. The difference between overhead incurred and overhead recovered (i. e. under absorbed or over absorbed overheads) is transferred to Overheads Adjustment Account.
- (v) *Work-in-Process Control Account*: Work-in-process control account is debited with the total cost of production, which includes direct materials, direct employee, direct expenses, production overhead recovered, and is credited with the amount of finished goods completed and transferred. The balance in this account represents total balance of jobs/works-in-process, as shown by several job accounts.
- (vi) *Administrative Overhead Control Account*: Administrative overhead control account is debited with overhead incurred and credited with overhead recovered. The overhead recovered are debited to Finished Goods Control Account, if administrative overhead is related with production activities, otherwise to cost of sales A/c. The difference between administrative overheads incurred and recovered is transferred to overhead adjustment account.
- (vii) *Finished Goods Control Account*: Finished goods control account is debited with the value of goods transferred from Work-in-process control account, administration costs recovered (if related to production activities). This account is credited with cost of sales account. The balance of this account represents the value of goods lying at hand.
- (viii) *Selling and Distribution Overhead Control Account*: Selling and distribution overhead control account is debited with selling and distribution overheads incurred and credited with the selling and distribution overheads recovered. The difference between overheads incurred and recovered is transferred usually to overhead adjustment account.
- (ix) *Cost of Sales Account*: Cost of sales account is debited with the cost of finished goods transferred from finished goods control account for sale, administrative overhead recovered, selling and distribution overhead recovered. The balance of this account is ultimately transferred to sales account or costing profit & loss account.
- (x) *Costing Profit & Loss Account*: Costing profit & loss account is debited with cost of goods sold, under-absorbed overheads and abnormal losses and is credited with sales value, over-absorbed overhead and abnormal gains. The net profit or loss in this account is transferred to cost ledger control account.



(xi) *Overhead Adjustment Account*: Overhead adjustment account will be debited for under-recovery of overhead and credited with over-recovery of overhead amount. The net balance in this account is transferred to costing profit & loss account.

**Note:** Sometimes, overhead adjustment account is not maintained and under/over absorbed overheads is directly transferred to costing profit & loss account from the respective overhead accounts.

**Illustration 8**

On 31<sup>st</sup> March, 2018 the following balances were extracted from the books of the ABC Ltd.

Particulars	Dr. (Rs.)	Cr. (Rs.)
Stores Ledger Control A/c	35,000	
Work-in-Process Control A/c	38,000	
Finished Goods Control A/c	25,000	
Cost Ledger Control A/c		98,000
	98,000	98,000

The following transactions took place in April 2018:

Particulars	(Rs.)
Raw Materials:	
- Purchased	95,000
- Returned to suppliers	3,000
- Issued to production	98,000
- Returned to stores	3,000
Productive wages	40,000
Indirect wages	25,000
Factory overhead expenses incurred	50,000
Selling and Administrative expenses	40,000
Cost of finished goods transferred to warehouse	2,13,000
Cost of Goods sold	2,10,000
Sales	3,00,000

Factory overheads are applied to production at 150% of direct wages, any under/over absorbed overhead being carried forward for adjustment in the subsequent months. All administrative and selling expenses are treated as period costs and charged off to the Profit and Loss account of the month in which they are incurred.

Show the following Accounts:

(a) Wages Control A/c	(b) Cost of Goods sold A/c
(c) Selling & Administrative Expenses A/c	(d) Cost Ledger Control A/c
(e) Stores Ledger Control A/c	(f) Work-in – Process Control A/c
(g) Finished Goods Stock Control A/c	(h) Factory Overhead Control A/c
(i) Costing Profit and Loss A/c	(j) Trial Balance as at 30 <sup>th</sup> April 2018

**Solution:**(a) **Cost Ledger Control A/c**

Particulars	(₹)	Particulars	(₹)
To Costing P & L A/c (sales)	3,00,000	By Balance b/d	98,000
To Stores Ledger Control A/c	3,000	By Stores Ledger Control A/c	5,000
		By Wages Control A/c (Productive+ Indirect wages)	65,000
		By Factory OH Control A/c	50,000
		By Selling & Admn. OH A/c	40,000
To Balance c/d	95,000	By Costing P & L A/c (profit)	50,000
<b>Total</b>	<b>3,98,000</b>	<b>Total</b>	<b>3,98,000</b>

(b) **Stores Ledger Control A/c**

Particulars	(₹)	Particulars	(₹)
To Balance b/d	35,000	By Cost Ledger Control A/c	3,000
To Cost Ledger Control A/c	95,000	By Work-in-process Control A/c	98,000
To work-in-process Control A/c	3,000	By Balance c/d	32,000
<b>Total</b>	<b>1,33,000</b>	<b>Total</b>	<b>1,33,000</b>

(c) **Work – in- Process Control A/c**

Particulars	(₹)	Particulars	(₹)
To Balance b/d	38,000	By Stores Ledger Control A/c	3,000
To Stores Ledger Control A/c	98,000	By Finished Goods Control A/c	2,13,000
To Wages Control A/c	40,000		
To Factory OH Control A/c	60,000	By Balance c/d	20,000
<b>Total</b>	<b>2,36,000</b>	<b>Total</b>	<b>2,36,000</b>

(d) **Finished Goods Control A/c**

Particulars	(₹)	Particulars	(₹)
To Balance b/d	25,000	By Cost of goods sold A/c	2,10,000
To Work-in-Process Control A/c	2,13,000	By Balance c/d	28,000
<b>Total</b>	<b>2,38,000</b>	<b>Total</b>	<b>2,38,000</b>

(e) **Factory Overhead Control A/c**

Particulars	(₹)	Particulars	(₹)
To Wages Control A/c (Indirect wages)	25,000	By Work-in-process A/c (150% of ₹40,000)	60,000
To Cost Ledger Control A/c	50,000	By Balance c/d	15,000
<b>Total</b>	<b>75,000</b>	<b>Total</b>	<b>75,000</b>



(f) **Costing Profit and Loss A/c**

Particulars	(₹)	Particulars	(₹)
To Cost of Goods Sold A/c	2,10,000	By Cost Ledger Control A/c (Sales)	3,00,000
To Selling and Admn. OH Control A/c	40,000		
To Cost Ledger Control A/c (Profit) (balancing figure)	50,000		
<b>Total</b>	<b>3,00,000</b>	<b>Total</b>	<b>3,00,000</b>

(g) **Trial Balance as at 30<sup>th</sup> April 2018**

Particulars	Dr. (₹)	Cr. (₹)
Stores Ledger Control A/c	32,000	
Work-in-Process Control A/c	20,000	
Finished Goods Control A/c	28,000	
Factory Overhead Control A/c	15,000	
Cost Ledger Control A/c		95,000
<b>Total</b>	<b>95,000</b>	<b>95,000</b>

**Working Note:**(i) **Wages Control A/c**

Particulars	(₹)	Particulars	(₹)
To Cost Ledger Control A/c	65,000	By Work-in-Process Control A/c	40,000
		By Factory OH Control A/c	25,000
<b>Total</b>	<b>65,000</b>	<b>Total</b>	<b>65,000</b>

(ii) **Cost of Goods Sold A/c**

Particulars	(₹)	Particulars	(₹)
To Finished Goods Control A/c	2,10,000	By Costing P & L A/c	2,10,000
<b>Total</b>	<b>2,10,000</b>	<b>Total</b>	<b>2,10,000</b>

(iii) **Selling & Administrative Expenses A/c**

Particulars	(₹)	Particulars	(₹)
To Cost Ledger Control A/c	40,000	By Costing P & L A/c	40,000
<b>Total</b>	<b>40,000</b>	<b>Total</b>	<b>40,000</b>

**4.4 INTEGRAL ACCOUNTS**

Integrated accounting system is the name given to a system of accounting, where by cost and financial accounts are kept in the same set of books. Obviously, then there will be no separate set of books for costing and financial records. Integral accounts provide or meet the information required by costing and financial accounts.

**Features of Integrated Accounting System**

- Complete analysis of costs and sales are kept.
- Complete details of all payments in cash are kept.
- Complete details of all assets and liabilities are kept and this system does not use a notional accounts to represent all impersonal accounts.
- Under this system, general ledger adjustment is not at all maintained and detailed accounts of assets and liabilities are maintained.

**Advantages of integrated accounting system**

The main advantages of integrated accounts are as follows

- No need for Reconciliation: The question of reconciling costing profit and financial profit does not arise, as there is one figure of profit only
- Significant saving in the clerical efforts, as only one set of books is maintained.
- Retrieving of information is easy & quick.
- It is economical also as it is based in the concept of centralization of accounting function.

**Essential pre-requisites for integrated accounts**

The essential pre-requisites for integrated accounts include the following steps

- The managements decision about the extent of integration of the two sets of books, some concerns find it useful to integrate upto the stage of primary cost or factory cost, while others prefer full integration of the entire accounting records.
- A suitable coding system must be made available so as to serve the accounting purposes of financial and cost accounts.
- An agreed routine, with regard to the treatment of provision for accruals, prepaid expenses, other adjustment necessary for preparation of interim accounts.
- Perfect coordination should exist between the staff responsible for the financial and cost aspects of the accounts and an efficient processing of accounting documents should be ensured.

The following table shows the comparative journal entries in financial accounts, cost accounts and integral accounts:

Sl. No.	Transaction	Financial Accounts	Cost Accounts	Integral Accounts
(i)	Credit purchase of Material	Purchases A/c To, Creditors A/c	Dr Material Control A/c To, General Ledger A/c	Dr Material Control A/c To, Creditors
(ii)	Cash purchase of materials	Purchases A/c To, Bank / Cash. A/c	Dr Material Control A/c To, General Ledger A/c	Dr Material Control A/c To, Cash



Sl. No.	Transaction	Financial Accounts	Cost Accounts	Integral Accounts
(iii)	Purchase of special material for direct use in job	Purchases A/c Dr To, Cash / Creditors. A/c	WIP Control A/c Dr To, General Ledger Adj A/c	WIP Control A/c Dr To, Cash or Creditors A/c
(iv)	Purchase of materials for repairs	Purchases A/c Dr To, Cash/Creditors. A/c	Factory OH control A/c Dr To, General Ledger Adj A/c	Factory OH control A/c Dr To, Cash / Creditors A/c
(v)	Materials returned to suppliers	Creditors A/c Dr To, Purchases A/c	General Ledger Control A/c. Dr To Material control A/c	Creditors A/c Dr To, Material Control A/c
(vi)	Payments to creditors for supplies made	Creditors A/c Dr To, Cash A/c	No Entry	Creditors A/c Dr To, Cash A/c
(vii)	Issue of direct materials to production shops	No Entry	WIP Control A/c Dr To, Materials Control A/c	WIP Control A/c Dr To, Materials Control A/c
(viii)	Issue of indirect materials to production shops	No Entry	Factory OH Control A/c Dr To, Material Control A/c	Factory OH control A/c Dr To, Material Control A/c
(ix)	Return of direct materials to stores	No Entry	Material Control A/c Dr To, WIP Control A/c	Material Control A/c Dr To, WIP Control A/c
(x)	Return of indirect materials to stores	No Entry	Material Control A/c Dr To, Factory Overheads A/c	Material Control A/c Dr To, Factory Overheads A/c
(xi)	Materials transferred from one Job to another	No Entry	No Entry	No Entry
(xii)	Adjustment of normal depreciation in material stocks	No Entry	Factory Overheads Control A/c Dr To, Material Control A/c	Factory Overheads Control A/c Dr To, Material Control A/c
(xiii)	Adjustment of normal surplus in material stocks	No Entry	Material Control a/c Dr To, Factory OH Control A/c	Material Control A/c Dr To, Factory OH Control A/c
(xiv)	Payment of wages & Salaries	Wages & Salaries A/c Dr To Cash / Bank A/c	Wages Control A/c Dr To, General Ledger A/c	Wages & Salaries A/c Dr To, Cash / Bank A/c
(xv)	Analysis of distribution of wages	No Entry	WIP Control A/c Dr POH Control A/c Dr Admin OH Control A/c Dr Sellings Dis OH Control A/c Dr To, Wages Control A/c.	WIP Control A/c Dr POH Control A/c Dr Admin OH Control A/c Dr Sellings Dis OH Control A/c Dr To, Wages Control A/c.
(xvi)	Payment of Expenses	Expenses A/c Dr To, Cash A/c	POH Control A/c Dr Admin OH Control A/c Dr Selling & Dis OH Control A/c Dr To, General Ledger Adj A/c	POH Control A/c Dr Admin OH Control A/c Dr Selling & Dis OH Control A/c Dr To, Cash A/c
(xvii)	Recording of Depreciation	Depreciation A/c Dr To, Asset A/c	POH Control A/c Dr Admin OH Control A/c Dr Selling & Dis OH Control A/c Dr To, General Ledger Adj A/c	POH Control A/c Dr Admin OH Control A/c Dr Selling & Dis OH Control A/c Dr To, Asset A/c



Sl. No.	Transaction	Financial Accounts	Cost Accounts	Integral Accounts
(xviii)	Absorption of Factory Overheads	No Entry	WIP Control A/c Dr To, Factory Overheads A/c	WIP Control A/c Dr To, Factory Overheads A/c
(xix)	Spoiled / Defective Work	No Entry	Costing Profit & Loss A/c Dr To, WIP Control A/c	Costing Profit & Loss A/c Dr To, WIP Control A/c
(xx)	Recording of Cost of Jobs completed	No Entry	Finished Goods Control A/c Dr To, WIP Control A/c	Finished Goods Control A/c Dr To, WIP Control A/c
(xxi)	Recording of Cost of goods sold	No Entry	Cost of Sales A/c Dr To, Finished goods A/c	Cost of Sales A/c Dr To, Finished goods Control A/c
(xxii)	Recording of sales	Cash/ Debtor A/c Dr To, Sales A/c	General Ledger Control A/c Dr To, Costing P&L A/c	Cash / Debtors A/c Dr To, P&L A/c
(xxiii)	Absorption of Administration Overheads	No Entry	Finished Goods Control A/c Dr To, Admin OH Control A/c	Finished Goods Control A/c Dr To, Admin OH control A/c
(xxiv)	Absorption of Selling Overheads	No Entry	Cost of Sales A/c Dr To, Selling & Dis. Overheads Control A/c	Cost of Sales A/c Dr To, Selling & Dis. OH Control A/c
(xxv)	Under absorption of overheads	No Entry	Costing Profit & Loss A/c Dr To, OH Control A/c	Profit & Loss A/c Dr To, OH control A/c
(xxvi)	Over absorption of overheads	No Entry	OH Control A/c Dr To, Costing P&L A/c	OH Control A/c Dr To, Costing P&L A/c

**Illustration 9**

Journalise the following transactions assuming that cost and financial accounts are integrated:

Particulars	Amount (₹)
Raw material purchased	40,000
Direct materials issued to production	30,000
Wages paid (30% indirect)	24,000
Wages charged to production	16,800
Manufacturing expenses incurred	19,000
Manufacturing overhead charged to Production	18,000
Selling and distribution cost	4,000
Finished products (at cost)	40,000
Sales	58,000
Closing stock	Nil
Receipts from debtors	13,800
payments to creditors	12,000

**Solution:****Journals**

<b>Particulars</b>		<b>Dr.</b>	<b>Cr.</b>
		<b>Amount (₹)</b>	<b>Amount (₹)</b>
Material Control A/c	Dr.	40,000	
To, Creditors A/c			40,000
Work In Progress Control A/c	Dr.	30,000	
To, Material Control A/c			30,000
Wages Control A/c	Dr.	24,000	
To, Cash A/c			24,000
Factory Overheads Control A/c	Dr.	7,200	
To, Wages Control A/c			7,200
Work-in-Progress Control A/c	Dr.	16,800	
To, Wages Control A/c			16,800
Factory Overhead Control A/c	Dr.	19,000	
To, Cash A/c			19,000
Work-in-Progress Control A/c	Dr.	18,000	
To, Factory overhead Control A/c			18,000
S & D O.H. Control A/c	Dr.	4,000	
To, Cash A/c			4,000
Cost of Sales A/c	Dr.	4,000	
To, Selling & Distribution Overhead Control A/c			4,000
Finished Goods Control A/c	Dr.	40,000	
To, Work-in-progress control A/c			40,000
Debtors A/c	Dr.	58,000	
To, Profit & Loss A/c			58,000
Cash A/c	Dr.	13,800	
To, Debtors A/c			13,800
Creditors A/c	Dr.	12,000	
To, Cash A/c			12,000

**Illustration 10**

Pass the journal entries for the following transactions in a double entry cost accounting system:

<b>Particulars</b>	<b>Amount (₹)</b>
(a) Issue of material : Direct	5,50,000
Indirect	1,50,000
(b) Allocation of wages and salaries : Direct	2,00,000
Indirect	40,000
(c) Overheads absorbed in jobs : Factory	1,50,000
Administration	50,000
Selling	30,000
(d) Under/over absorbed overheads : Factory (Over)	20,000
Admn . (Under)	10,000



**Solution:**

<b>Journals</b>		<b>Dr.</b>	<b>Cr.</b>
<b>Particulars</b>		<b>Amount (₹)</b>	<b>Amount (₹)</b>
Work In Progress Control A/c	Dr.	5,50,000	
Factory Overheads Control A/c	Dr.	1,50,000	
To Material Control A/c			7,00,000
Work In Progress Control A/c	Dr.	2,00,000	
Factory Overheads Control A/c	Dr.	40,000	
To Wages Control A/c			2,40,000
Work In Progress Control A/c	Dr.	1,50,000	
Finished goods Control A/c	Dr.	50,000	
Cost of Sales A/c	Dr.	30,000	
To Factory Overhead Control A/c			1,50,000
To Administrative Overhead Control A/c			50,000
To Selling Overhead Control A/c			30,000
Costing Profit & Loss A/c	Dr.	10,000	
To Administrative Overhead Control A/c			10,000
Factory Overhead Control A/c	Dr.	20,000	
To Costing Profit & Loss A/c			20,000

**Illustration 11**

Messrs Essbee Ltd. maintains Integrated Accounts of Cost and Financial Accounts. From the following details write up Control Accounts of a factory and prepare a Trial Balance.

<b>Particulars</b>	<b>Amount (₹)</b>
Share Capital	3,00,000
Reserve	2,00,000
Sundry Creditors	5,00,000
Plant and Machinery	5,75,000
Sundry Debtors	2,00,000
Closing Stock	1,50,000
Bank & Cash Balance	75,000

TRANSACTIONS DURING THE YEAR WERE AS FOLLOWS:

<b>Particulars</b>	<b>Amount (₹)</b>
Stores purchased	10,00,000
stores issued to production	10,50,000
Stores in hand	95,000
Direct wages incurred	6,50,000
Direct wages charged to production	6,00,000
Manufacturing expenses incurred	3,00,000
Manufacturing expenses charged to production	2,75,000
Selling and distribution expenses	1,00,000
Finished stock production (at cost)	18,00,000
Sales at selling price	22,00,000
Closing stock	95,000
Payments to creditors	11,00,000
Receipts from debtors	21,00,000

**Solution:**

Dr.		Creditors Account		Cr.	
Particulars	Amount (₹)	Particulars	Amount (₹)		
To, Cash A/c	11,00,000	By, Balance b/d	5,00,000		
To, Balance c/d	4,00,000	By, Material Control A/c	10,00,000		
	<b>15,00,000</b>		<b>15,00,000</b>		
		By, Balance b/d	4,00,000		

Dr.		Debtors Account		Cr.	
Particulars	Amount (₹)	Particulars	Amount (₹)		
To, Balance b/d	2,00,000	By, Cash A/c	21,00,000		
To, P & L A/c	22,00,000	By, Balance c/d	3,00,000		
	<b>24,00,000</b>		<b>24,00,000</b>		
To, Balance b/d	3,00,000				

Dr.		Material Control A/c (or) Stores Ledger Control Account		Cr.	
Particulars	Amount (₹)	Particulars	Amount (₹)		
To, Balance b/d	1,50,000	By, Work-in-Progress Control A/c	10,50,000		
To, Creditors A/c	10,00,000	By, Manufacturing Overhead Control A/c	5,000		
	<b>11,50,000</b>	By, Balance c/d	95,000		
To, Balance b/d	95,000		<b>11,50,000</b>		

Dr.		Cash & Bank Account		Cr.	
Particulars	Amount (₹)	Particulars	Amount (₹)		
To, Balance b/d	75,000	By, Wages Control A/c	6,50,000		
To, Debtors A/c	21,00,000	By, Manufacturing Overhead Control A/c	3,00,000		
		By, Selling and Distribution O.H. Control A/c	1,00,000		
		By, Creditors A/c	11,00,000		
		By, Balance c/d	25,000		
	<b>21,75,000</b>		<b>21,75,000</b>		
To, Balance b/d	25,000				

Dr.		Work-in-Progress Control Account		Cr.	
Particulars	Amount (₹)	Particulars	Amount (₹)		
To, Material Control A/c	10,50,000	By, Fixed Goods Control A/c	18,00,000		
To, Wages Control A/c	6,00,000	By, Balance c/d	1,25,000		
To, Manufacturing Overhead Control A/c	2,75,000				
	<b>19,25,000</b>		<b>19,25,000</b>		
To, Balance b/d	1,25,000				

Dr.		Wages Control Account		Cr.	
Particulars	Amount (₹)	Particulars	Amount (₹)		
To Cash & Bank A/c	6,50,000	By, Work-in-Progress Control A/c	6,00,000		
		By, Manufactures Overhead Control A/c	50,000		
	<b>6,50,000</b>		<b>6,50,000</b>		



**Dr. (Factory) Manufacturing Overhead Control Account Cr.**

Particulars	Amount (₹)	Particulars	Amount (₹)
To, Cash	3,00,000	By, Work-in-Progress Control A/c	2,75,000
To, Material Control A/c	5,000	By, Profit & Loss A/c	80,000
To, Wages Control A/c	50,000		
	<b>3,55,000</b>		<b>3,55,000</b>

**Dr. Selling & Distribution Overhead Control Account Cr.**

Particulars	Amount (₹)	Particulars	Amount (₹)
To, Cash A/c	1,00,000	By, Cost of Sales A/c	1,00,000
	<b>1,00,000</b>		<b>1,00,000</b>

**Dr. Finished goods Control Account Cr.**

Particulars	Amount (₹)	Particulars	Amount (₹)
To, Work-in-Progress Control A/c	18,00,000	By, Cost of Sales	17,05,000
		By, Balance c/d	95,000
	<b>18,00,000</b>		<b>18,00,000</b>
To, Balance b/d	95,000		

**Dr. Profit & Loss Account Cr.**

Particulars	Amount (₹)	Particulars	Amount (₹)
To, Factory Overheads Control A/c	80,000	By, Debtors A/c (Sale)	22,00,000
To, Cost of Sales	18,05,000		
To, Reserve A/c (Profit)	3,15,000		
	<b>22,00,000</b>		<b>22,00,000</b>

**Dr. Cost of Sales Account Cr.**

Particulars	Amount (₹)	Particulars	Amount (₹)
To, Selling & Distribution Control A/c	1,00,000	By, Profit & Loss A/c	18,05,000
To, Finished Goods Control A/c	17,05,000		
	<b>18,05,000</b>		<b>18,05,000</b>

**Trial Balance**

Amount (₹)

Particulars	Debit	Credit
Share Capital		3,00,000
Reserves (2,00,000 + 3,15,000)		5,15,000
Creditors		4,00,000
Plant & Machinery	5,75,000	
Debtors	3,00,000	
Closing Stock:		
Material	95,000	
Work-in-progress	1,25,000	
Finished goods	95,000	
Cash & bank	25,000	
	<b>12,15,000</b>	<b>12,15,000</b>





**Illustration 12**

The following balances are shown in the Cost Ledger of Vinak Ltd. as on 1st October, 2016:

Particulars	Dr. (₹)	Cr. (₹)
Work in progress Account	7,056	
Factory overheads suspense Account	360	
Finished stock Account	5,274	
Stores Ledger Control Account	9,450	
Administration Overheads Suspense A/C	180	
General Ledger Adjustment Account		22,320

**Transactions for the year ended 30th september, 2017**

Particulars	Amount (₹)
Stores issued to production	45,370
Stores purchased	52,400
Material purchased for direct issued to production	1,135
Wages paid (including indirect labour ₹ 2,520)	57,600
Finished goods sold	1,18,800
Administration expenses	5,400
Selling expenses	6,000
Factory overheads	15,600
Store issued for Capital work-in-Progress	1,500
Finished goods transferred to warehouse	1,08,000
Store issued for factory repairs	2,000
Factory overheads recovered to production	16,830
Administration overheads charged to production	4,580
Factory overheads applicable unfinished work	3,080
selling overheads allocated to sales	5,500
Stores lost due to fire in store (not insured)	150
Administration expenses on unfinished work	850
Finished goods stock on 30.9.2016	14,274

You are required to record the entries in the cost ledger for the year ended 30th September, 2017 and prepare a Trial Balance as on that date.

**Solution:**

Dr.		Cr.	
<b>Work-in-Progress Control Account</b>			
Particulars	Amount (₹)	Particulars	Amount (₹)
To, Balance b/d	7,056	By, Finished Goods Control A/c	1,08,000
To, Material Control A/c	45,370	By, Balance c/d	
To, General Ledger Adjustment A/c	1,135	Factory Overhead	3,080
To, Wages control A/c	55,080	Admn. O.H.	850
To, Factory overhead control A/c	16,830	Material & Wages	<u>22,051</u>
To, Administrative Overhead Control A/c	4,580		25,981
To, Factory Overhead Control A/c	3080		
To, Administrative Overhead Control A/c	850		
	<b>1,33,981</b>		<b>1,33,981</b>
To Balance b/d	25,981		



**Dr. Factory Overhead Suspense Account Cr.**

Particulars	Amount (₹)	Particulars	Amount (₹)
To, Balance b/d	360	By, Work-in-Progress Control A/c	3,080
To, Wages Control A/c	2,520	By, Work-in-Progress Control A/c	16,830
To, General Ledger Adjustment A/c	15,600	By, Balance c/d	570
To, Material Control A/c	2,000		
	<b>20,480</b>		<b>20,480</b>
To, Balance b/d	570		

**Dr. Finished Goods Control Account Cr.**

Particulars	Amount (₹)	Particulars	Amount (₹)
To, Balance b/d	5,274	By, Cost of Sales A/c	99,000
To, Work-in-progress Control A/c	1,08,000	By, Balance c/d	14,274
	<b>1,13,274</b>		<b>1,13,274</b>
To, Balance b/d	14,274		

**Dr. Material Control Account Cr.**

Particulars	Amount (₹)	Particulars	Amount (₹)
To, Balance b/d	9,450	By, Work-in-Progress Control A/c	45,370
To, General Ledger Adjustment A/c	52,400	By, Capital Work-in-Progress Control A/c	1,500
		By, Factory Overhead Suspense A/c	2,000
		By, Costing Profit & Loss A/c	150
		By, Balance c/d	12,830
	<b>61,850</b>		<b>61,850</b>
To, Balance b/d	12,830		

**Dr. Administrative Overhead Control Account Cr.**

Particulars	Amount (₹)	Particulars	Amount (₹)
To, Balance c/d	180	By, Work-in-Progress Control A/c	4,580
To, General Ledger Adjustment A/c	5,400	By, Work-in-Progress Control A/c	850
		By, Balance c/d	150
	<b>5,580</b>		<b>5,580</b>
To, balance b/d	150		

**General Ledger Adjustment (GLA) Account**

**Dr. (or) Cost Ledger Control (CLC) Account Cr.**

Particulars	Amount (₹)	Particulars	Amount (₹)
To, Costing Profit & Loss A/c	1,18,800	By, Balance b/d	22,320
To, Balance c/d	55,805	By, Material Control A/c	52,400
		By, Work-in-Progress Control A/c	1,135
		By, Wages Control A/c	57,600
		By, Administrative Overhead Control A/c	5,400
		By, Factory Overhead Control A/c	15,600
		By, Selling and Distribution Overhead Control A/c	6,000
		By, Costing Profit & Loss A/c	14,150
	<b>1,74,605</b>		<b>1,74,605</b>
		By Balance b/d	55,805



**Dr. Wages Control Account Cr.**

Particulars	Amount (₹)	Particulars	Amount (₹)
To, General Ledger Adjustment A/c	57,600	By, Work-in-Progress Control A/c	55,080
		By, Factory Overhead Control A/c	2,520
	<b>57,600</b>		<b>57,600</b>

**Dr. Costing Profit & Loss Account Cr.**

Particulars	Amount (₹)	Particulars	Amount (₹)
To, Material Control A/c	150	By, General Ledger Adjustment Control A/c (Sales)	1,18,800
To, Cost of Sales	1,04,500		
To, General Ledger Adjustment Control A/c (profit)	14,150		
	<b>1,18,800</b>		<b>1,18,800</b>

**Dr. Selling and Distribution Overhead Control Account Cr.**

Particulars	Amount (₹)	Particulars	Amount (₹)
To, General Ledger Adjustment A/c	6,000	By, Cost of Sales A/c	5,500
		By, Balance c/d	500
	<b>6,000</b>		<b>6,000</b>
To Balance b/d	500		

**Dr. Capital Work-in-progress Account Cr.**

Particulars	Amount (₹)	Particulars	Amount (₹)
To, Material Control A/c	1,500	By, Balance c/d	1,500
	<b>1,500</b>		<b>1,500</b>
To, balance b/d	1,500		

**Dr. Cost of Sales Account Cr.**

Particulars	Amount (₹)	Particulars	Amount (₹)
To, Selling & Distribution Control A/c	5,500	By, Costing Profit & Loss A/c	1,04,500
To, Finished Goods Control A/c	99,000		
	<b>1,04,500</b>		<b>1,04,500</b>

**Trial Balance Amount (₹)**

Particulars	Debit	Credit
Work-in-Progress Control	25,981	
Factory overhead Suspense	570	
Finished Goods Control	14,274	
Material Control	12,830	
Administrative Overhead Control	150	
General Ledger Adjustment		55,805
Selling and Distribution Overhead Control	500	
Capital Work-in-Progress	1,500	
	<b>55,805</b>	<b>55,805</b>



## 4.5 RECONCILIATION OF COST ACCOUNTING RECORDS WITH FINANCIAL ACCOUNTS

Where no separate accounts are maintained for costing and finance, the question of reconciliation does not arise. But where the cost and financial accounts are maintained independently of each other, it is indispensable to reconcile them. Though both the sets of accounts are same as far as the basic transactions are concerned but there are differences in the profits of two sets of books.

### Reasons for difference in profits of cost and financial accounts

#### (i) Items shown in Financial Accounts

There are a number of items which are included in financial accounts but do not find place in cost accounts. They may be items of income or expenses, the former increases the profit and latter reduces the profit.

##### A. Purely Financial Charges

- (a) Loss arising from the sale of fixed assets.
- (b) Loss on sale of investments, discount on debentures, etc.
- (c) Interest on bank loan, mortgage and debentures.
- (d) Expenses of companies 'Share Transfer Office'.

##### B. Appropriation of Profits

- (a) Donations and Charities
- (b) Income Tax
- (c) Dividend Paid
- (d) Transfer to Reserves

##### C. Writing off Intangible and Fictitious Assets

- (a) Goodwill
- (b) Patents & Copyrights
- (c) Advertisement
- (d) Preliminary Expenses

##### D. Pure Financial Incomes

- (a) Rent received or Profit on Sale of Fixed Assets
- (b) Share transfer fee received
- (c) Interest received on Bank Deposits
- (d) Dividend received etc.

#### (ii) Items shown only in Cost Accounts

There are certain items which are included in cost accounts and not in financial accounts. Such items are very few.

E.g. Interest on capital employed, rent for own premises etc.

**(iii) Over or Under Absorption of Overheads.**

Overheads are absorbed in Cost Accounts on a certain predetermined estimated basis and in Financial Accounts, actual amounts incurred are recorded. If there is any over or under absorption it leads to difference in the profits of both sets of books.

**(iv) Differences due to different basis of stock valuation and depreciation methods.****Objects of Reconciliation**

- (a) To assure the mathematical accuracy and reliability of cost accounts
- (b) To have proper cost control and ascertainment
- (c) To find out the reasons for the profit or loss shown by the financial accounts
- (d) To ensure correct profit or loss in financial accounts
- (e) To ensure true and fair view of balance sheet of the business concern

**Procedure for reconciliation**

Take Profits as per Financial Accounts.

**Add :**

- (a) Items of income included in Cost Accounts but not in Financial Accounts.
- (b) Items of expenditure included in Financial and not in Cost Accounts.
- (c) Amounts by which items of income have been shown in excess in Cost Accounts over the corresponding entries in Financial Accounts.
- (d) Amounts by which items of expenditure have been shown in excess in Financial Accounts over the corresponding entries in Cost Accounts.
- (e) Under absorption of overheads in Cost Accounts.
- (f) The amount by which closing stock of inventory is overvalued in Cost Accounts.
- (g) The amount by which opening stock of inventory is undervalued in Cost Accounts.

**Less :**

- (a) Items of income included in Financial Accounts but not in Cost Accounts.
- (b) Items of expenditure (as interest on Capital, Rent on owned premises etc.) included in Cost Accounts but not in Financial Accounts.
- (c) Amounts by which items of expenditure have been shown in excess in Cost Accounts as compared to the corresponding entries in Financial Accounts.
- (d) Amounts by which items of incomes have been shown in excess in Financial Accounts as compared to the corresponding entries in Cost Accounts.
- (e) Over absorption of overheads in Cost Accounts.
- (f) The amount by which closing stock of inventory is undervalued in Cost Accounts.
- (g) The amount by which opening stock of inventory is overvalued in Cost Accounts.

**Illustration 13**

The net profits of a manufacturing company appeared at ₹ 64,500 as per financial records for the year ended 31st December, 2016. The cost books however, showed a net profit of ₹ 86,460 for the same period. A careful scrutiny of the figures from both the sets of accounts revealed the following facts.

	₹
(i) Income-tax provided in financial books	20,000
(ii) Bank Interest (Cr) in financial books	250
(iii) Work overhead under recovered	1,550
(iv) Depreciation charged in financial records	5,600
(v) Depreciation recovered in cost	6,000
(vi) Administrative overheads over-recovered	850
(vii) Loss due to obsolescence charged in financial accounts	2,800
(viii) Interest on Investments not included in cost accounts	4,000
(ix) Stores adjustments (Credit in financial books)	240
(x) Loss due to depreciation in stock value	3,350

Prepare Reconciliation Statement.

**Solution:****Statement showing reconciliation of profit shown by cost and financial accounts as on 31-12-2016:**

Particulars	Amount (₹)	Amount (₹)
Profit as per Financial Accounts		64,500
Add: Income tax provided in financial books only.	20,000	
Works overhead under recovered	1,550	
Loss to obsolescence considered. Financial A/c only.	2,800	
Loss due to depreciation in stock	3,350	27,700
		92,200
Less: Bank interest credited in financial books.	250	
Over recovery of depreciation	400	
Administration OH's over recovered	850	
Interest on investment not included in cost books	4,000	
Stores adjustment	240	5,740
Profit as per Cost Accounts		86,460

**Illustration 14**

The net profits shown by financial accounts of a company amounted to ₹18,550 whilst the profits disclosed by company's cost account for that period were ₹ 28,660. On reconciling the figures, the following difference were noted.



	Amount (₹)
(i) Director's fee not charged in cost accounts	650
(ii) A provision for bad and doubtful debts	570
(iii) Bank interest (cr.)	30
(iv) Income-tax	8,300
(v) Overheads in the cost accounts were estimated at ₹8,500. The charges shown by the financial books was ₹8,320.	
(vi) Work was started during the year on a new factory and expenditure ₹16,000 was incurred. Depreciation of 5% was provided in financial accounts.	

Prepare a Statement Reconciling the figures shown by the cost and financial accounts.

**Solution:**

**Statement showing reconciliation of profit shown by cost and financial accounts**

Particulars	Amount (₹)	Amount (₹)
Profit as per Financial Accounts		18,550
Add: Directors fee	650	
Provision for bad debts	570	
Income tax	8,300	
Depreciation in financial books only	800	10,320
		28,870
Less: Bank interest	30	
Over recovery of overheads	180	210
Profit as per Cost Accounts		28,660

**Illustration 15**

M/s Mysore Petro Ltd. showed a net loss of ₹ 2,08,000 as per their financial accounts for the year ended 31st March, 2017. The cost accounts, however, disclosed a net loss of ₹1,64,000 for the same period. The following information was revealed as a result of the scrutiny of the figures of both the sets of books.

	Amount (₹)
(i) Factory overhead under recovered	3,000
(ii) Administration overhead over recovered	2,000
(iii) Depreciation charged in financial books	60,000
(iv) Depreciation recovered in costs	65,000
(v) Interest on investment not included in costs	10,000
(vi) Income-tax provided	60,000
(vii) Transfer fee ( in financial Books)	1,000
(viii) Stores adjustment (credit in financial books)	1,000

Prepare Reconciliation Statement.

**Solution:****Statement Showing Reconciliation of Profit Shown by Cost and Financial Accounts**

Particulars	Amount (₹)	Amount (₹)
Profit as per Financial Accounts		(2,08,000)
Add: Under recovery of factory overheads	3,000	
Income tax	60,000	63,000
		(1,45,000)
Less: Over recovery of Administration OH	2,000	
Over recovery of depreciation	5,000	
Interest on investments considered in Financial A/c	10,000	
Transfer fee	1,000	
Stores adjustment	1,000	19,000
Loss as per Cost Accounts		(1,64,000)

**Illustration 16**

During a particular year, the auditors certified the financial accounts, showing profit of ₹1,68,000 whereas the same, as per costing books was coming out to be ₹ 2,40,000. Given the following information you are asked to prepare a Reconciliation Statement showing the reasons for the gap.

Dr.		Trading and Profit and Loss Account		Cr.	
Particulars	Amount (₹)	Particulars	Amount (₹)		
To, Opening stock A/c	8,25,000	By, Sales	34,65,000		
To, Purchases A/c	24,72,000	By, Closing stock A/c	7,50,000		
To, Direct wages A/c	2,30,000				
To, Factory overhead A/c	2,10,000				
To, G.P. C/d	4,83,000				
	42,15,000		42,15,000		
To, Admn. Expenses A/c	95,000	By, G.P. b/d	4,83,000		
To, Selling Expenses A/c	2,25,000	By, Sundry Income A/c	5,000		
To, Net profit	1,68,000				
	4,88,000		4,88,000		

The costing records show:

- (i) Book value of closing stock ₹7,80,000
- (ii) Factory overheads have been absorbed to the extent of ₹1,89,800
- (iii) Sundry income is not considered
- (iv) Total absorption of direct wages ₹2,46,000
- (v) Administrative expenses are covered at 3% of selling price.
- (vi) Selling prices include 5% for selling expenses.





**Solution:**

**Statement Showing Reconciliation of Profit Shown by Cost and Financial Accounts**

Particulars	Amount (₹)	Amount (₹)
Profit as per Financial Accounts		1,68,000
Add: Over valuation of Closing stock in Cost Accounts (7,80,000 - 7,50,000)	30,000	
Under recovery of works overhead (2,10,000 - 1,89,800)	20,200	
Under recovery of selling expenses in Cost Accounts. (2,25,000 – 1,73,250*)	51,750	1,01,950
		2,69,950
Less: Sundry income not considered in Cost Accounts	5,000	
Over recovery of wages (2,46,000 - 2,30,000)	16,000	
Over recovery Administration expenses (1,03,950** - 95,000)	8,950	29,950
Profit as per Cost Accounts		2,40,000

\* 5% of 34,65,000 = 1,73,250

\*\* 3% of 34,65,000 = 1,03,950

**Illustration 17**

A transistor manufacturer, who commenced his business on 1st June, 2017 supplies you with the following information and asks you to prepare a statement showing the profit per transistor sold. Wages and materials are to be charged at actual cost, works overhead at 75% of wages and office overhead at 30% of works cost. Number of transistors manufactured and sold during the year was 540.

**Other particulars:**

Materials per set                    ₹ 240

Wages per set                        ₹ 80

Selling price per set                ₹ 600

If the actual works expenses were ₹32,160 and office expenses were ₹61,800, prepare a Reconciliation Statement.

**Solution:**

**Cost Sheet (or) Statement of Cost and Profit**

**Amount (₹)**

Particulars	Unit	Total
Material	240	1,29,600
Wages	80	43,200
Prime cost	320	1,72,800
(+) Works overhead (75% of wages)	60	32,400
Works cost	380	2,05,200
(+) Office overheads (30% of work cost)	114	61,560
Total cost	494	2,66,760
(+) Profit	106	57,240
Sales	<b>600</b>	<b>3,24,000</b>

**Dr. Trading and Profit & Loss Account Cr.**

Particulars	Amount (₹)	Particulars	Amount (₹)
To, Materials A/c	1,29,600	By, Sales A/c	3,24,000
To, Wages A/c	43,200		
To, Works Overheads A/c	32,160		
To, Gross Profit	1,19,040		
	3,24,000		3,24,000
To, Office Expenses	61,800	By, Gross Profit b/d	1,19,040
To, Net Profit	57,240		
	1,19,040		1,19,040

**Statement of Reconciliation**

Particulars	Amount (₹)
Profit as per Financial Accounts	57,240
(-) Over recovery of works overheads (32,160 - 32,400)	(240)
(+) Under recovery of office expenses (61,800 - 61,560)	240
Profit as per Cost Accounts	57,240

**Illustration 18**

Given below is the Trading and Profit and Loss Account of Vikas Electronics for the accounting year ended 31st March, 2017.

**Dr. Trading and Profit & Loss Account Cr.**

Particulars	Amount (₹)	Particulars	Amount (₹)
To, Direct Materials consumed	3,00,000	By, Sales A/c (2,50,000 units @ ₹ 3)	7,50,000
To, Direct Wages A/c	2,00,000		
To, Factory expenses A/c	1,20,000		
To, Office Expenses A/c	40,000		
To, Selling & Distribution Exp. A/c	80,000		
To, Net profit	10,000		
	<b>7,50,000</b>		<b>7,50,000</b>

Normal output of the factory is 2,00,000 units. Factory overheads are fixed upto ₹60,000 and office expenses are fixed for all practical purposes, selling and distribution expenses are fixed to the extent of ₹50,000 the rest are variable. Prepare a Statement of Reconciliation of Profit as per Cost Accounts and Financial Accounts.

**Solution:****Cost Sheet (or) Statement of Cost and Profit**

Particulars	Amount (₹)	Amount (₹)
Material consumed		3,00,000
Direct wages		2,00,000
Prime cost		5,00,000
(+) <b>Works/Factory expenses</b>		
Fixed (60,000 x 2,50,000/2,00,000)	75,000	
Variable (1,20,000 - 60,000)	60,000	1,35,000
Works cost		6,35,000
(+) Office expenses (40,000 x 2,50,000/2,00,000)		50,000
Cost of production		6,85,000
(+) <b>Selling &amp; Distribution expenses</b>		
Fixed (50,000 x 2,50,000/2,00,000)	62,500	
Variable (1,20,000 - 60,000)	30,000	92,500
Cost of sales/Total cost		7,77,500
(-) Loss		(27,500)
Sales		7,50,000

**Statement of Reconciliation**

Particulars	Amount (₹)	Amount (₹)
Profit as per Financial Accounts		10,000
Add:		
Less: Over recovery of factory overheads (1,35,000 - 1,20,000)	15,000	
Over recovery of office expenses (50,000 - 40,000)	10,000	
Over recovery of Selling & Distribution overheads (92,500 - 80,000)	12,500	37,500
Loss as per Cost Accounts		27,500

**Illustration 19**

The following is the Trading and Profit and Loss account of M/s. Time and Trading limited for the year ended 31.12.2016.

**Dr. Trading and profit & Loss Account Cr.**

Particulars	Amount (₹)	Particulars	Amount (₹)
To, Materials consumed	7,08,000	By, Sales A/c (30,000 units)	15,00,000
To, Direct Wages A/c	3,71,000	By, Finished stock A/c (1,000 units)	40,000
To, Works overheads A/c	2,13,000	By, Work-in-progress:	
To, Admn. overheads A/c	95,500	Materials	17,000
To, Selling and Distribution overheads A/c	1,13,500	Wages	8,000
To, Net profit	69,000	Works OH	5,000
	15,70,000		15,70,000



Manufacturing a standard unit, the company's cost records show that:

- (i) Works overheads have been charged to work-in-progress at 20% on prime cost.
- (ii) Administration overheads have been recovered at ₹3 per finished unit.
- (iii) Selling and distribution overheads have been recovered at ₹4 per unit sold.
- (iv) The unabsorbed or over absorbed overheads have not been adjusted into costing profit and loss account.

**Prepare:**

- (a) A Costing Profit and Loss Account indicating Net Profit.
- (b) A Statement Reconciling the Profit as disclosed by Cost Accounts and that shown in Financial Accounts.

**Solution:**

**Costing Profit & Loss Account**

Particulars	Amount (₹)	Particulars	Amount (₹)
To, Materials	7,08,000	By, Sales	15,00,000
To, Direct wages	3,71,000		
Prime Cost	10,79,000		
To, Works OH (20%)	2,15,800		
	12,94,800		
(-) Closing WIP	30,000		
Works cost	12,64,800		
To, Administration OH's (31,000 x 3)	93,000		
Cost of Production	13,57,800		
(-) Closing stock (13,57,800 x 1,000/31,000)	43,800		
Cost of goods sold	13,14,000		
To, Selling expenses (30,000 x 4)	1,20,000		
	14,34,000		
To Profit	66,000		
	15,00,000		15,00,000

**Statement of Reconciliation**

Particulars	Amount (₹)	Amount (₹)
Profit as per Financial Accounts		69,000
Add: Under recovery of Admn. overheads (95,500 - 93,000)	2,500	
Over valuation of closing stock in Cost A/c's (43,800 - 40,000)	3,800	6,300
Less: Over recovery of Works overheads (2,15,800 - 2,13,800)	2,800	
Over recovery of Selling & Distribution overheads (1,20,000 - 1,13,500)	6,500	9,300
Profit as per Cost Accounts		66,000

**Illustration 20**

The financial profit and loss account of a manufacturing company for the year ended 31st March, 2017 is given below:

Dr.		Trading and Profit & Loss Account		Cr.	
Particulars	Amount (₹)	Amount (₹)	Particulars	Amount (₹)	
To, Opening stock A/c			By, Sales A/c	4,60,000	
Raw Materials	25,000		By, Closing stock A/c		
Finished Stock	40,000		Materials	30,000	
W.I.P.	12,500	77,500	Finished stock	15,000	
To, Purchases A/c		1,20,000	W.I.P.	20,700	
To, Wages (Factory) A/c		30,000			
To, Electric Power (Factory) A/c		65,000			
To, Gross Profit c/d		1,82,200			
		5,25,700			5,25,700
To, Administration Expenses A/c		20,500	By, Gross Profit b/d	1,88,200	
To, Selling Expenses A/c		46,500	By, Misc. Revenue A/c	26,800	
To, Bad Debts A/c		15,600			
To, Net Profit A/c		1,32,400			
		2,15,000			2,15,000

The cost accounts of the concern showed a net profit of ₹ 1,32,200. It is seen that the costing profit and loss account is arrived at on the basis of figures furnished below:

Opening stock of raw materials, finished stock and work-in-progress ₹ 90,800

Closing stock of raw materials, finished stock and work-in-progress ₹ 69,500

You are required to prepare a Memorandum Reconciliation Account and reconcile the difference in the profit and loss account.

**Solution:**

Dr.		Memorandum Reconciliation Account		Cr.	
Particulars	Amount (₹)	Particulars	Amount (₹)		
To, Over valuation of op. stock in Cost A/c	13,300	By, Profit as per financial A/c	1,32,400		
To, Miscellaneous revenue	26,800	By, Over valuation of closing Stock in cost A/c	3,800		
To, Profit as per cost A/c	1,32,200	By, Bad debts not considered in cost A/c.	15,600		
		By, Admn. expenses not considered in cost A/c	20,500		
	1,72,300				1,72,300

**Illustration 21**

The following figures have been extracted from financial accounts of a manufacturing firm for the first year of its operation.

	<b>Amount (₹)</b>
Direct material consumption	50,00,000
Direct wages	30,00,000
Factory OH	16,00,000
Administration OH	7,00,000
Selling and distribution OH	9,60,000
Bad debts	80,000
Preliminary expenses written off	40,000
Legal charges	10,000
Dividends received	1,00,000
Interest on deposit received	20,000
Sales (1,20,000 units)	1,20,00,000
Closing stock	
Finished stock - 4,000 units	3,20,000
Work-in-progress	2,40,000

The cost accounts for the same period reveal that the direct material consumption was ₹56,00,000. Factory OH recovered at 20% on prime cost; Administration OH is recovered @ ₹6 per unit of production; Selling and Distribution OH are recovered at ₹8 per unit sold.

You are required to prepare Costing and Financial Profit and Loss Accounts and reconcile the difference in the profit in the two sets of accounts.

**Solution:****Dr.****Costing P & L Account****Cr.**

Particulars	Amount (₹)	Particulars	Amount (₹)
To, Materials	56,00,000	By, Sales	1,20,00,000
To, Direct wages	30,00,000		
To, Prime cost	86,00,000		
To, Factory OH's (20%)	17,20,000		
	1,03,20,000		
(-) Closing WIP	2,40,000		
Factory Cost	1,00,80,000		
To, Admin. OH's (1,24,000 x 6)	7,44,000		
Cost of Production	1,08,24,000		
(-) Closing stock of FG (1,08,24,000 x 4,000/1,24,000)	3,49,161		
Cost of goods sold	1,04,74,839		
To, Selling overheads	9,60,000		
To, Profit	5,65,161		
	1,20,00,000		1,20,00,000



**Dr. Financial Trading and P & L Account Cr.**

Particulars	Amount (₹)	Particulars	Amount (₹)
To, Materials A/c	50,00,000	By, Dividend A/c	1,00,000
To, Wages A/c	30,00,000	By, Interest on deposit	20,000
To, Factory OH A/c	16,00,000	By, Sales A/c	1,20,00,000
To, Admn. OH A/c	7,00,000	By, Closing stock A/c	
To, S & D OH A/c	9,60,000	Finished goods	3,20,000
To, Bad debts A/c	80,000	WIP	2,40,000
To, Preliminary expenses written off	40,000		
To, Legal charges A/c	10,000		
To, Net Profit	12,90,000		
	12,68,000		12,68,000

**Statement of Reconciliation**

Particulars	Amount (₹)	Amount (₹)
Profit as per Financial Accounts		12,90,000
Add: Over valuation of cl. Stock of Finished goods in Cost Accounts	29,161	
Pure financial expenses not considered in Cost Accounts (80,000 + 40,000 + 10,000)	1,30,000	1,59,161
Less: Over recovery of material	6,00,000	
Over recovery of FOH	1,20,000	
Over recovery of AOH	44,000	
Financial incomes not considered in Cost Accounts.	1,20,000	8,84,000
Profit as per Cost Accounts		5,65,161

**Illustration 22**

The following represent the Trading and Profit and Loss Account of a manufacturer of a standard fire extinguisher:

**Dr. Trading and P&L Account Cr.**

Particulars	Amount (₹)	Particulars	Amount (₹)
To, Materials used	29,150.00	By, Sales A/c	75,000.00
To, Productive Wages A/c	18,610.00	By, Stock of Finished Goods A/c	1,812.50
To, Factory Expenses A/c	14,055.00	By, Work-in-progress:	
To, Gross Profit c/d	20,527.50	Materials	2,800.00
		Labour	1,560.00
		Overheads	1,170.00
	82,342.50		82,342.50
To, Administration expenses A/c	13,650.00	By, Gross Profit b/d	20,527.00
To, Net Profit	6,877.50		
	20,527.50		20,527.50



1,550 Extinguishers were manufactured during the year, and 1,500 were sold during the same period. The cost records showed that Factory overheads work out at ₹ 8.25 and Administrative overheads at ₹ 9.0625 per article produced: the Cost Accounts showing an estimated total profit of ₹ 7,031.25 for the year.

From the forgoing information you are required to prepare

- Factory Overhead Control of Account
- Administration overheads Control Account in costing books and
- An account showing reconciliation between the total net profit as per the Cost Accounts and the net profit shown in Financial Books.

**Solution:**

Dr.		Factory Overhead Control Account		Cr.	
Particulars	Amount (₹)	Particulars	Amount (₹)		
To, GLA A/c	14,055	By, FG control (1550 x 8.25)	12,787.50		
		By, WIP	1,170.00		
		By, Under recovery	97.50		
	14,055				14,055

Dr.		Administration Overhead Control Account		Cr.	
Particulars	Amount (₹)	Particulars	Amount (₹)		
To, GLA A/c	13,650.000	By, FG (1550 x 9.0625)	14,046.875		
To, Over recovery	396.875				
	14,046.875				14,046.875

Dr.		Memorandum Reconciliation Account		Cr.	
Particulars	Amount (₹)	Particulars	Amount (₹)		
To, Over recovery of AOH	396.875	By, Profit as per Financial A/c	6,877.500		
To, Profit as per Cost Accounts	<b>7,031.250</b>	By, Under recovery of FOH	97.500		
		By, Over Valuation of Closing Stock in Cost Accounts (50 x 9.0625)	453.125		
	7,428.125				7,428.125





## 4.6 INFRASTRUCTURE, EDUCATIONAL, HEALTHCARE AND PORT SERVICES

### INFRASTRUCTURE SECTOR

The Infrastructure activity which, inter alia includes building / re-building / restoring structures or infrastructure facilities, typically using civil, mechanical or other branches of engineering, plays an important role in the development of the economy as it has multiplier effect across various sectors creating investment opportunities.

The infrastructure industry contributes a significant share of the country's GDP and employment.

Features of an infrastructure contract / project are as follows:

- Execution of projects as a contractor / sub-contractor or as a developer
- Projects involving design, detailed engineering, procurement, manufacturing/fabrication, installation, commissioning
- The contracts / projects are finalised normally through a bidding process and the projects are executed as per client's requirements at client's project site.
- The client normally makes payment based on the progress of work as per the contract.
- Contracts also normally stipulate work / quality certification by a client nominated third party consultant.
- Contracts also lay down performance guarantee conditions, warranty / defect liability period, liquidated damages for schedule delay, price variation clause if any, client's obligations during construction period, method to be followed for any change in scope of work, claim management, force-majeure clause, arbitration etc.
- The duration of a project may vary from project to project for different industries. Normally the projects are of long duration (more than 12 months) and revenue is recognised generally based on Indian Accounting Standard (Ind AS-11) notified by Government of India, Ministry of Corporate Affairs.

### Cost Management in Infrastructure Sector

To have uniformity and consistency in the treatment of various elements of cost, it is desirable that companies shall lay down a cost accounting policy which shall be adopted for determining the cost of the project. The policy shall cover the following areas:

- Identification of cost centres / cost objects (projects) and cost drivers
- Accounting for material cost, stores at store yards, employee cost, and other relevant cost components
- Accounting, allocation and absorption of Overheads
- Accounting for Depreciation / Amortization, Transfer in and transfer out of equipment from the site.
- Accounting for scraps, wastage etc.
- Basis for Inventory Valuation
- Methodology for valuation of Inter-Unit / Inter Company and Related Party transactions
- Treatment of abnormal and non-recurring costs including classification of other non cost item



## EDUCATION SECTOR

Education imparts knowledge and skills and shapes values and attitudes. Education is vital for progress of a civil society. Education forms the backbone of a nation and is one of the most important key indicators of a country's growth and development. The rise of knowledge economy at a global level has reinforced education, in all its forms (elementary, secondary, higher, vocational, and adult), as the key economic and business driver.

Education acts as a driver for technological innovation and facilitates absorption of developed technology for the benefit of the mankind. It is now widely accepted that knowledge capital, holds the key to development of economy.

With the emergence of India as a knowledge-based economy human capital has now become its major strength. This has put the spotlight on severe inadequacies of India's infrastructure for delivery of education, particularly higher education.

The social rates of return on investments in all levels of education much exceed the long-term opportunity cost of capital. At the same time, since it is difficult to measure the social rate of return, the financial ROI, becomes a key driver for sustaining and enhancing the investments in education sector.

### Cost Management in Education Sector

Today, the aim of the top management of colleges and universities is to improve transparency into their services, operations and finances for their stakeholder and the public. There is also a growing interest among the institutions of higher education to enhance risk management through better controls over their entity systems, policies and procedures, and to promote the importance of accountability among professionals.

Within these organizations, management information system, performance management and cost review plays a pivotal role in working with administrators, management and boards to establish strong cost spending controls and derive the many resulting benefits in terms of organizational performance and cost efficiencies.

The cost/finance controller can help the Higher Educational Institutions in overcoming the threats and weaknesses of their internal management and system. And can also open and widen the areas according to their strengths and visible opportunities.

The Management of Higher Educational Institutions shall undertake the following review to evaluate and improve the effectiveness of risk management, cost control and governance processes:

- **Systems evaluation** – assessing the control systems in place within a specific area, to support the achievement of the areas objectives;
- **Stock evaluation** – undertake stock take of library books, IT equipment, laboratory equipment, stationary, college furniture etc.
- **Compliance evaluation** – assessing compliance against an agreed set of standards, e.g. UGC norms, AICTE norms ;
- **Contract evaluation and cost review**– auditing procurement projects and capital programmes, assessing compliance with best practice (policies and procedures), cost reviews for expenditure on institution infrastructure, staff payroll, administration etc.;
- **Thematic work reviews** – to be undertaken across a number of departments, identifying areas of good practice and producing an overall report for all areas of Institution with respect to budgetary controls, spending analysis, achieving value for money etc.;
- **Revenue assurance** – undertaking assurance review to confirm that departments have appropriate controls in place for fee collections, timely deposits, etc.;
- **Grant reviews** – to ensure that the grants are used for the intended purpose.



## HEALTHCARE SECTOR

One of the important objectives of Government is to improve in standard of living and health status of its population. For this, government endeavors to provide its populations accessible, affordable, awareness and quality healthcare. Indian Government is also making continuous efforts to improve the standard of living and health status of its population and it remains one of the primary objectives in Indian planning. The 12<sup>th</sup> five year plans (2012-17) focuses on providing universal healthcare infrastructure, promoting R&D and enacting strong regulation for the Health Sector. India's health care system have mixed treatment ownership patterns and with different systems of medicine – primary Allopathy & Homoeopathy, co existing with indigenous system like Ayurvedic, Unani, and Siddha.

The proper goal of a health care delivery system is to “Touch & Enriching billion Lives with creating certain set of value” i.e. Patient Centricity, Ownership, & integrity to patients. Objective in health care is measured in terms of the patient outcomes achieved per rupee expended. It is not the number of different services provided or the volume of services delivered that matters but the true status of health.

### **Cost Management can be a useful tool for management in Health Care Sector to:**

- Estimate the reasonable cost of Health care resources used in patient care
- Performance measurement of all the Cost & Revenue drivers
- Lower health care cost without compromising on quality of services rendered or extended
- Define the Health care delivery value chain
- Determine the fees or tariffs for goods and services
- Estimate the capacity of each resources and comparison with actual utilization
- Authorise, modify or discontinue a programme or activity
- Manage materials & its storage and associated costs in terms of consumables, drugs, etc.

### **Cost Management in Health Care Sector:**

- Break down the revenue streams from different services
- Break down the costs to different cost centers & map costs to activities
- Match the revenues with costs using the activity links
- Remove non cost items like discretionary costs, sunk costs
- Remove non operating revenues like interest received, miscellaneous income
- Add risk premium to cover inherent risks in the project
- Identify and quantify cost drivers
- Match cost pools with suitable cost drivers
- Decide on suitable allocation keys and apportion costs to objects
- Compare cost of each service group with revenues generated and arrive at profitability



## PORT SECTOR

The ports sector in India is divided into “Major Ports” and “Non-Major Ports” which are under the jurisdiction of Central Government and State Governments respectively. The legal framework governing the sector comprises the Indian Ports Act of 1908 and the Major Port Trusts Act of 1963. Major Ports under Central jurisdiction are governed by policy and directives of Ministry of Shipping of Government of India. Minor Ports under State’s jurisdiction and governed by policy and directives of respective State Government’s nodal departments/ agencies.

Tariff Authority for Major Ports (TAMP) has been constituted for regulating tariffs in major ports and its functioning/role is being revised to ensure uniform and transparent norms relating to fixing tariffs as well as prescribing quality of service for port authorities/terminal operators.

The Management of Port Sector shall undertake the following review to evaluate and improve the effectiveness of risk management, cost control and governance process;

- To ensure that the internal control are in place as set by the management for the attainment of the objective of the business,
- Management need to review that the internal control are in place in relation to revenue collection and its proper accounting,
- To ensure that the grant if issued by the government must be used for the specific purpose for which it is granted,
- To ensure that the contract enter with the various client is operating in order and its adherence are in place as this is incidental with the revenue of the entity.

## GLOSSARY

**Cost Collection:** Cost collection is the process of booking costs against a particular cost account code under a particular cost centre or directly under a cost unit, as the case may be.

**Cost Control Accounts:** Cost control accounts are accounts maintained for the purpose of exercising control over the costing ledgers and also to complete the double entry in cost accounts.

**Integral Accounting:** Integrated accounting system is a system of accounting, whereby cost and financial accounts are kept in the same set of books. Integral accounts provide the information required by costing and financial accounts.

**Non-Integral Accounting:** Non-Integrated accounting system is a system of accounting where two sets of books are maintained- (i) for costing transactions; and (ii) for financial transactions.

### SELF EXAMINATION QUESTIONS:

1. Give the specimen of Cost Sheet.
2. Discuss the Cost Management techniques used in the following sector:
  - a. Infrastructure sector
  - b. Education sector
  - c. Healthcare sector
  - d. Port sector
3. How do you prepare Cost Sheet?

**PRACTICE PROBLEMS:**

4. Prakash Transport Company has been given a route of 20 km long to run a bus. The bus costs ₹12,50,000 with an estimated useful life of 5 years. It is insured @ 3% pa of the cost. Annual tax amounted to ₹25,000. The garage rent is ₹5,000 per month. Annual repairs cost is estimated as ₹50,000.

The driver is paid a salary of ₹7,500 per month and the conductor is paid ₹5,000 per month in addition to a 10% of takings as commission to be shared equally by them.

Office Stationery would ₹1,000 pm and Office Salaries ₹10,000 pm.

Diesel will cost @ ₹30 per liter and the bus would travel a distance of 5 km per liter. The bus will make 3 round trips carrying on an average 40 passengers on each trip. Assuming a profit of 15% on takings, calculate the fare to be charged from each passenger. The bus will operate for 25 days in a month.

[Ans: Price per Passenger KM = ₹ 0.85]

5. The City Pride Theatre has revealed the following estimates of their cinema hall:

Salary 1 manager ₹ 8,000 pm, 10 door keepers ₹2,000 pm, 2 operators ₹4,000 pm, 4 booking clerks ₹2,500 pm

**Annual expenses:**

Electricity	₹ 12,00,000
Carbon	₹ 3,00,000
Misc. expenses	₹ 1,50,000
Advertising	₹ 7,50,000 (it would earn income of ₹25,000 on advertisements shown in the hall)
Hire of films	₹ 15,00,000 per film on 15 films
Administration expenses	₹ 80,000

The premises cost ₹60 lacs and are to be depreciated over 15 years. Projector and other equipments cost ₹25 lacs and to be depreciated @ 25% pa.

The plan is to have 3 daily shows on all 360 days in a year. The capacity is 625 seats divided into

Lower class	250	
Upper class	250	and
Balcony	125	

20% of the seats are estimated to be vacant. The weightages to be given to the three classes are in the ratio of 1:2:3.

If the management wishes to earn a profit of 25% on gross proceeds, find out the rates to be charged for each class. Round off to nearest rupee.

[Ans: Rates of the ticket per seat Lower class ₹ 36.29; Upper class ₹ 72.57; Balcony ₹ 108.86.]



### Multiple Choice Questions

1. Which of the following items is not included in preparation of cost sheet?
  - A. Carriage inward
  - B. Purchase returns
  - C. Sales commission
  - D. Interest paid
2. Which of the following items is not excluded while preparing a cost sheet?
  - A. Goodwill written off
  - B. Provision for taxation
  - C. Property tax on Factory building
  - D. Transfer to reserves
  - E. Interest paid
3. Which of the following are direct expenses?
  - A. The cost of special designs, drawings or layouts
  - B. The hire of tools or equipment for a particular job
  - C. Salesman's wages
  - D. Rent, rates and insurance of a factory
    - a. (1) and (2)
    - b. (1) and (3)
    - c. (1) and (4)
    - d. (3) and (4)
4. What is prime cost
  - A. Total direct costs only
  - B. Total indirect costs only
  - C. Total non-production costs
  - D. Total production costs
5. Which of the following is not an element of works overhead?
  - A. Sales manager's salary
  - B. Plant manager's salary
  - C. Factory repairman's wages
  - D. Product inspector's salary



6. For the purpose of Cost sheet preparation, costs are classified based on:
  - A. Functions
  - B. Relevance
  - C. Variability
  - D. Nature
  - E. All of the above
  
7. Salary paid to an office supervisor is a part of:
  - A. Direct expenses
  - B. Administration cost
  - C. Quality control cost
  - D. Factory overheads
  - E. None of the above
  
8. Audit fees paid to cost auditors is part of:
  - A. Selling & Distribution cost
  - B. Production cost
  - C. Administration Cost
  - D. Not recorded in the cost sheet
  - E. None of the above
  
9. A company has set up a laboratory for testing of products for compliance with standards. Salary of this laboratory staffs are part of:
  - A. Direct Expenses
  - B. Quality Control Cost
  - C. Works overheads
  - D. Research & Development Cost
  - E. None of the above
  
10. Canteen expenses for factory workers are part of:
  - A. Administration Cost
  - B. Factory overhead
  - C. Marketing cost
  - D. None of the above
  - E. All of the above



11. Which of the following does not form part of prime cost:
  - A. GST Paid on raw materials (input credit can be claimed)
  - B. Cost of transportation paid to bring materials to factory
  - C. Cost of packing
  - D. Overtime premium paid to workers.
  - E. None of the above
12. A company pays royalty to State Government on the basis of production, it is treated as:
  - A. Direct Expenses
  - B. Factory overheads
  - C. Direct Material Cost
  - D. Administration cost
  - E. None of the above
13. In Reconciliations Statements Expenses shown only in financial accounts are.
  - A. Added to financial profit
  - B. Deducted from financial profit
  - C. Ignored
  - D. Added to costing profit
14. In Reconciliation Statement Expenses shown only in cost accounts are.
  - A. Added to financial profit
  - B. Deducted from financial profit
  - C. Ignored
  - D. Deducted from costing profit
15. In Reconciliation Statement, transfers to reserves are.
  - A. Added to financial profit
  - B. Deducted from financial profit
  - C. Ignored
  - D. Added to costing profit
16. In Reconciliation Statement, Incomes shown only in financial accounts are.
  - A. Added to financial profit
  - B. Deducted from financial profit
  - C. Ignored
  - D. Deducted from costing profit





17. In Reconciliation Statement, Closing Stock Undervalued in Financial accounts is
  - A. Added to financial profit
  - B. Deducted from financial profit
  - C. Ignored
  - D. Added to costing profit
18. Under non-integrated accounting system
  - A. Separate ledgers are maintained for cost and financial accounts
  - B. Same ledger is maintained for cost and financial accounts by accountants
  - C. (a) and (b) both
  - D. None of the above
  - E. All of the above
19. Under non-integrated accounting system, the account made to complete double entry is:
  - A. Finished goods control account
  - B. Work in progress control account
  - C. Stores ledger control account
  - D. General ledger adjustment account
  - E. None of the above
20. Under non-integrated system of accounting, purchase of raw material is debited to
  - A. Purchase account
  - B. Material control account/ stores ledger control account
  - C. General ledger adjustment account
  - D. None of the above
21. When costing loss is ₹ 5,600, administrative overhead under-absorbed being ₹ 600, the loss as per financial accounts should be
  - A. ₹ 5,000
  - B. ₹ 5,600
  - C. ₹ 6,200
  - D. None of the above
22. Which of the following items should be added to costing profit to arrive at financial profit:
  - A. Income tax paid
  - B. Over-absorption of works overhead
  - C. Interest paid on debentures
  - D. All of the above
  - E. None of the above



23. Integral accounts eliminate the necessity of operating
- A. Cost Ledger control account
  - B. Store Ledger control account
  - C. Overhead adjustment account
  - D. None of the above
24. What entry will be passed under integrated system for purchase of stores on credit?
- A. Dr. Stores  
Cr. Creditors
  - B. Dr Stores ledger control A/c  
Cr Creditors
  - C. Dr Stores Ledger control A/c  
Cr General Ledger adjustment A/c
25. What entry will be passed under integrated system for payment to creditors for supplies made?
- A. Dr Creditors  
Cr Cash
  - B. Dr. Creditors  
Cr Stores Ledger Control A/c
  - C. No entry
26. The accounting entry in integrated accounts for recording sales will be:
- A. Dr. Cost ledger control account  
Cr Profit and loss account
  - B. Dr. Sales account  
Cr Profit and Loss A/c
  - C. Dr. Cash A/c  
Cr. Sales A/c
27. What will be the accounting entry for absorption of factory overhead?
- A. Dr. Works in progress control A/c  
Cr Factory overhead control A/c
  - B. Dr. Factory overhead  
Cr. Factory overhead control A/c
  - C. No entry is required

[Ans: D, C, A, A, A, A, B, C, B, B, C, A, A, B, A, B, A, A, D, B, C, B, A, B, A, C, A]



**State the following statements are true or false:**

1. Total cost = prime cost + All indirect costs.
2. Closing stock of work-in-progress should be valued on the basis of prime cost.
3. Closing stock of finished goods should be valued on the basis of cost of sales.
4. Production cost includes only direct costs related to the production.
5. Primary packaging cost is included in distribution cost.
6. Notional interest on Owner's capital appears only in financial profit and loss A/c.
7. Goodwill written off appears only in cost accounts.
8. Overheads are taken on estimated basis in financial accounts.
9. Expenses which appears only in financial accounts and not in cost accounts, are Generally notional items.
10. Need for Reconciliation arise in case of integrated system of accounts.
11. Cost ledger control account makes the cost ledger self balancing.
12. Stock ledger contains the accounts of all items of finished goods.
13. The purpose of cost control accounts is to control the cost.
14. Cost control accounts are prepared on the basis of double entry system.
15. The balancing in costing profit and loss account represents under or over absorption of overheads.

[Ans: T, F, F, F, F, F, F, F, F, F, T, T, F, T, F]

**Fill in the Blanks:**

1. Prime cost + Overheads = \_\_\_\_\_
2. Total cost + Profit = \_\_\_\_\_
3. \_\_\_\_\_ + Profit = Sales.
4. Direct Material + \_\_\_\_\_ + Direct Expenses = Prime Cost.
5. Salary paid to factory manager is an item of \_\_\_\_\_.
6. In Reconciliations Statements, Incomes shown only in Financial accounts are \_\_\_\_\_.
7. In Reconciliations Statements, Expenses shown only in cost accounts are \_\_\_\_\_.
8. In Reconciliations Statements, overheads Over-Recovered in cost accounts are \_\_\_\_\_.
9. In Reconciliations Statements, overheads Under Recovered in cost accounts are \_\_\_\_\_.
10. Notional remuneration to owner is expense debited only in \_\_\_\_\_.
11. All the transactions relating to materials are recorded through \_\_\_\_\_.
12. The net balance of \_\_\_\_\_ represents net profit or net loss.



13. WIP ledger contains the accounts of all the \_\_\_\_\_ which are under \_\_\_\_\_.
14. The two traditional systems of accounting for integration of cost and financial accounts are the \_\_\_\_\_ and \_\_\_\_\_.
15. Under integrated accounting system, the accounting entry for payment of wages is to debit \_\_\_\_\_ and to credit cash.

[Ans: Total cost, Selling Price, Cost of Sales, Direct wages, Factory Overhead, Added to costing profit, Added to costing profit, Deducted from costing profit, Added to financial profit, Cost Accounts, Store ledger control accounts, Costing profit and loss account, Jobs Execution, Double entry method –the third entry method, Wages control Accounts.]

**Match the following:**

	Column A		Column B
1.	Primary Packing Materials Consumed	A	Not shown in cost sheet but debited to profit & loss account
2.	Captive power plant expense	B	Forms part of office & adm. Expenses
3.	Cash discount allowed	C	Forms part of selling expenses
4.	Scrap value of abnormal loss of finished output	D	Treated as part of factory expenses
5.	Cost of free samples of products distributed	E	Treated as direct expenses
6.	Depreciation on computer purchased for office	F	Not shown in cost sheet but credited to profit & loss account
7.	Donations	G	Expenses debited only in the financial accounts
8.	Interest paid on loan	H	Appropriations only in financial accounts
9.	Notional Rent charged to	I	Expenses debited only in cost accounts
10.	Notional interest on Owner's capital	J	Income credited only in cost accounts

[Ans: E, D, A, F, C, B, H, G, J, I]



# Study Note - 5

## METHODS OF COSTING

### This Study Note includes

- 5.1 Job Costing
- 5.2 Batch Costing
- 5.3 Contract Costing
- 5.4 Process Costing – Joint & By-Products
- 5.5 Operating Costing or Service Costing – Transport, Hotel and Hospital

### 5.1 JOB COSTING

#### Methods or Types of Costing

Costing is the technique and process of ascertaining costs. In order to do the same, it is necessary to follow a particular method of ascertaining cost. Different methods of costing are applied to different industries depending upon the type of manufacture and their nature. Broadly the costing methods are classified into the following:

- (a) Specific Order Costing (Job or Terminal Costing)
- (b) Operation Costing or Process or Period Costing

**Specific Order Costing:** Specific order costing is the category of basic costing methods applicable where the work consists of separate jobs, batches or contracts each of which is authorised by a specific order or contract. It includes job costing consisting batch costing and contract costing.

#### Job Order Costing

CIMA London defines job costing as “the category of basic costing methods which is applicable where the work consists of separate contracts, jobs or batches each of which is authorised by specific order or contract”.

Industries which manufacture products or render services against specific orders as distinct from continuous production for stock or sales use the job costing or job order method of cost accounting. The method is also known under various other names, such as specific order costing, production order costing, job lot costing or lot costing. Every order in job costing is separate and it is not essential that the same manufacturing operations be carried out or the same materials be utilized in respect of each. However, a number of identical orders or identical products may be combined together to form lots or batches, each such lot or batch constituting a job order. In the job costing system, an order or a unit, lot, or batch of a product may be taken as a cost unit, i.e. a job.

In job costing, there is no averaging of costs except to the extent that in the ascertainment of unit cost, the cost of a lot of products in one order is obtained. A job or an order may extend to several accounting periods and job costs are, therefore, not related to particular periods.



Job cost accounting is followed in three types of manufacturing organisations:

- (i) Jobbing concerns
- (ii) Small firms
- (iii) Large enterprises manufacturing a variety of products

### **(i) Jobbing concerns**

Some concerns manufacture a variety of products according to customer's specifications and do not generally confine their activities to producing uniformly any specific product for sale in the market. The jobs, products or services are dissimilar or unique and non-repetitive having different specifications and methods of manufacture, and each one requires different types, sizes and quantities of materials and equipments and utilizes different labour hours. Such concerns must of necessity to use job cost accounting.

### **(ii) Small firms**

Though manufacturing a number of specific products, small manufacturing concerns may find process costing difficult to apply because due to small sales, no product can have a run long enough to establish a product line. On account of the frequent changes from one product to another, job costing would be suitable for determining the cost of each lot of products.

### **(iii) Large enterprises manufacturing a variety of products**

A single department would be manufacturing several products, perhaps all at a time, so that none of the departments is specialized for continuous runs of product lines. As definite process departments cannot be established, job costing is more suitable in such cases.

Job costing is applicable to engineering concerns, construction companies, ship-building, furniture making, hardware and machine manufacturing industries, repair shops, automobile garages and several such other industries where jobs or orders can be kept separate.

### **Procedure for Job Cost Accounting**

On receipt of an order from the customer or an indication from the sales department for manufacturing a particular product, the production planning department prepares a suitable design for the product or job. It also works out the requirements of materials for the product and prepares a list of operations indicating the various operations to be carried out and their sequence, and the shops, departments, plants or machines to be entrusted with each of the operations.

A Production Order is issued giving instructions to the shops to proceed with the manufacture of the product. The production order constitutes the authority for work. Usually a production order contains all relevant information regarding production, such as detailed particulars of the job or product, the quantity or units to be manufactured, date of start of production, probable date of completion, details of materials required as per the bill of materials, the operations and the various shops involved in performing them and the route of the job should take.

The production order usually lays down only the quantities of materials required and the time allowed for the operations, but the values of materials and labour are also sometimes indicated. In the later case, the production order serves the combined purpose of an order for manufacture as well as the cost sheet on which the cost of the order is compiled.

The production order also provides for the material and labour on account of normal wastage or spoilage of the product in the final stage or during the various stages of manufacture.



Production orders may, in general, be of three types:

- (i) Assembly type of order
- (ii) Sub-assembly type of order
- (iii) Components or parts production type

**(i) Assembly type of order**

Where components are purchased and assembled into a product in the factory. A production order for assembly only is required.

**(ii) Sub-assembly type of order**

Components are purchased and sub-assemblies and assemblies are made in the factory. Production orders for each sub-assembly and final assembly will be necessary.

**(iii) Components or parts production type**

Components are manufactured and sub-assembled and the sub-assemblies are assembled into the final product. Separate production orders for each component, sub-assembly and final assembly are issued.

Copies of Production Orders may be distributed as follows:

- (a) One copy to the stores for provisioning and issue of materials on demand
- (b) One copy each to the departments or shops concerned to undertake production by demanding materials and employing men and machines on the operations
- (c) One copy to the cost department for working out the cost of the job

Separate job cost sheets are maintained for each job. If a job consists of several major or important operations, separate cost sub-sheets for recording the costs of the various operations may be maintained and the aggregate cost, in summary, shown in the main cost sheet.

### **Material Cost**

On receipt of a production order, the shop draws the requisite materials from the stores. Surplus, excess or incorrect materials are returned from the shops to the stores on materials return notes. Scrap and waste arising in the course of manufacture are returned in a similar manner. The materials requisitions, materials return notes and materials transfer notes are 'costed' in accordance with the methods of pricing adopted by the concern.

### **Labour Cost**

Labour summaries or wages analysis sheets are prepared for each accounting period and the totals of these statements are debited to Work-in-Progress Account or Overhead Control Account by credit to Wages Control Account. Amounts on account of overtime, idle time, shift differential and fringe benefits may also be included in the wages analysis sheet. Direct labour costs are posted on the respective cost sheets and indirect labour is treated in the manner indicated for indirect material.

### **Manufacturing Overhead**

Overhead costs are accumulated against standing order numbers and against cost centres. Overhead rates, predetermined or actual as the case may be, are worked out for each such centre. The overhead applied to each job is obtained by multiplying the overhead rate by the actual base variable spent on the job.



### **Completion of Jobs**

Postings of direct material, direct labour, direct expenses and manufacturing overhead costs to the cost sheet for a job or production order are made periodically throughout the run of the job or order. The completion report is an indication that the manufacturing operations are over and further expenditure on the job should cease so that the cost sheet may not be closed.

### **Work-in-Progress**

The cost of an incomplete job i.e., a job on which some manufacturing processes or operations are still due before it can be made into the finished product is termed Work-in-Progress or Work-in-Process. If a production order has been only partly completed by the end of an accounting period, it is essential that the closing stock of the work-in-progress be determined.

### **Cost Control in Job Order System**

Control over job costs may be exercised by comparison of the actual costs with the estimated costs established as basis for fixing job prices. Here again, adequate cost control is available for direct material and direct labour only; overhead costs cannot be controlled in terms of individual jobs. Control of overhead is, therefore, confined to the department as a whole for which predetermined overhead rate has been determined.

Comparison may also be made with the costs of previous periods or of earlier batches of production, if any. Standard costs may be used in job type plants, particularly where the product or the particular operations of the job are of a standardised nature.

### **Advantages of Job Costing**

Job costing offers the following advantages:

- (a) The cost of material, labour and overhead for every job or product in a department is available daily, weekly or as often as required while the job is still in progress.
- (b) On completion of a job, the cost under each element is immediately ascertained. Costs may be compared with the selling prices of the products in order to determine their profitability and to decide which product lines should be pushed or discontinued.
- (c) Historical costs for past periods for each product, compiled by orders, departments, or machines, provide useful statistics for future production planning and for estimating the costs of similar jobs to be taken up in future. This assists in the prompt furnishing of price quotations for specific jobs.
- (d) The adoption of predetermined overhead rates in job costing necessitates the application of a system of budgetary control of overhead with all its advantages.
- (e) The actual overhead costs are compared with the overhead applied at predetermined rates; thus, at the end of an accounting period, overhead variances can be analyzed.
- (f) Spoilage and defective work can be easily identified with specific jobs or products.
- (g) Job costing is particularly suitable for cost-plus and such other contracts where selling price is determined directly on the basis of costs.

### **Limitations of Job Costing**

The limitations of job costing are:

- (a) Job costing is comparatively more expensive as more clerical work is involved in identifying each element of cost with specific departments and jobs.





- (b) With the increase in the clerical processes, chances of errors are enhanced.
- (c) The cost as ascertained, even where they are compiled very promptly, are historical as they are compiled after incidence.
- (d) The cost compiled under job costing system represents the cost incurred under actual conditions of operation. The system does not have any scientific basis.

### Job Cost Card/Sheet

Each job is dissimilar to other due to specific and customised requirements. In order to ascertain cost of a particular job, it is necessary to record all the expenditure related to a job separately. For this purpose, job cost card/sheet is used. Job cost card is a cost sheet, where the quantity of materials issued, hours spent by different class of employees, amount of other expenses and share of overheads are recorded. This is helpful in knowing the total cost, profitability etc. of a job. A format of job cost card/sheet is shown below.

### JOB COST SHEET

Description: Blue print No: Material No: Reference No:			Job No: Quantity: Date of delivery: Date commenced: Date finished:		
Date	Reference	Details	Material	Labour	Overhead
		Total			
Summary of Costs	Estimated (₹)	Actual (₹)	For the job: Units produced: Cost/unit: Remarks: Prepared by: Checked by:		
Direct material cost					
Direct wages					
Production overhead					
PRODUCTION COST					
Administration and Selling & Distribution overheads					
TOTAL COST					
Profit/Loss					
SELLING PRICE					

**Accounting of Costs for a Job****Entries in Control Accounts**

1.	<i>For purchase of materials:</i> Stores Ledger Control A/c..... To Cost Ledger Control A/c*	Dr.
2.	<i>For the value of direct materials issued to job:</i> Work-in-Process control A/c ..... To Stores Ledger Control A/c	Dr.
3.	<i>For return of direct materials from jobs:</i> Stores Ledger Control A/c..... To Work-in-Process Control A/c	Dr.
4.	<i>For return of materials to suppliers:</i> Cost Ledger Control A/c..... To Stores Ledger Control A/c	Dr.
5.	<i>For indirect materials:</i> Factory Overhead Control A/c ..... To Stores Ledger Control A/c	Dr.
6.	<i>For wages paid:</i> Wages Control A/c ..... To Cost Ledger Control A/c	Dr.
7.	<i>For direct wages incurred on jobs:</i> Work-in-Process Control A/c ..... To Wages Control A/c	Dr.
8.	<i>For indirect wages:</i> Factory Overhead Control A/c ..... To Wages Control A/c	Dr.
9.	<i>For any indirect expense paid:</i> Factory Overhead Control A/c ..... To Cost Ledger Control A/c	Dr.
10.	<i>For charging overhead to jobs:</i> Work-in-Process Control A/c ..... To Factory Overhead Control A/c	Dr.
11.	<i>For the total cost of job completed:</i> Cost of Sales A/c..... To Work-in-Process Control A/c	Dr.
12.	<i>The balance of Cost of Sales A/c is transferred to Costing Profit and loss A/c;</i> <i>For such transfer:</i> Costing Profit and loss A/c..... To Cost of Sales A/c	Dr.
13.	<i>For the sales value of jobs completed:</i> Cost Ledger Control A/c..... To Costing profit and loss A/c**	Dr.

**Note:**

\* General ledger adjustment account is the other name of Cost Ledger Control Account.

\*\* The balance of Costing profit and loss account shall now represent profits or loss. The balance of Cost Ledger Control Account shall be carried forwarded. With the balance on all the accounts Trial Balance can be drawn.

## Reports in Job Costing System

### Report on profits on completed jobs

A statement may be prepared monthly to indicate the gross profit earned on all jobs completed during the month. This statement is useful for the management for evaluating past performances. Net profit analysis may also be made in a similar manner if administration, selling and distribution overheads for the job are included in the statement.

### Report on cost variances

If cost estimates are developed, a cost variance report showing the deviations of actual costs from the estimated costs may be prepared in order that significant differences may be brought to light and investigated. The report may be prepared separately for a job, or for a department showing the variances in respect of all jobs undertaken by the department during a period.

### Illustration 1

As newly appointed Cost Accountant, you find that the selling price of Job No. 9669 has been calculated on the following basis:

Particulars		Amount (₹)
Materials		12.08
Direct Wages – 22 hours at 25 paise per hour		5.50
Department	A – 10 hours, B – 4 hours, C – 8 hours	
Prime Cost		17.58
Plus 33% on Prime Cost		5.86
		23.44

An analysis of the previous year's profit and loss account shows the following:

Particulars	Amount (₹)	Particulars	Amount (₹)
Materials Used	77,500	Factory Overheads:	
Direct Wages:		A	2,500
A	5,000	B	4,000
B	6,000	C	1,000
C	4,000	Selling Costs	30,000

You are required to:

- Calculate and enter the revised costs using the previous year's figures as a basis;
- Draw up a Job Cost Sheet;
- Add to the total job cost 10% for profit and give the final selling price.

**Solution:**

(a)

In order to draw up Job Cost Sheet, the factory overhead rates of different departments and percentage of selling cost will have to be determined first on the basis of previous year's figures as follow:

**Factory Overhead Rates:**

Amount (₹)

Particulars	Department		
	A	B	C
Direct Wages (i)			
Factory Overheads (ii)	2,500	4,000	1,000
Direct Labour Hours (D.W. x 4) (iii)	20,000	24,000	16,000
Factory Overhead Rates per hour (ii ÷ iii)	0.125	0.167	0.063

**Working Notes:**

Materials used	77,500
Direct Wages [A = 5,000, B = 6,000, C = 4,000]	15,000
Factory Overhead [A = 2,500, B = 4,000, C = 1,000]	7,500
Works Cost	1,00,000
Selling Costs	30,000
Cost of Sales	1,30,000

$$\text{Percentage of Selling Cost on Works Cost} = \frac{\text{₹30,000}}{\text{₹1,00,000}} \times 100 = 30\%$$

(b)

**Cost Sheet**

Job No. 9669		Period
Particulars		Amount (₹)
Materials		12.08
Direct Wages:		
Dept. A	2.50	
Dept. B	1.00	
Dept. C	2.00	5.50
Prime Cost		17.58
Factory Overheads:		
Dept. A (10 hours. @ ₹ 0.125)	1.25	
Dept. B (4 hours. @ ₹ 0.167)	0.67	
Dept. C (8 hours. @ ₹ 0.063)	0.50	2.42
Works Cost		20.00
Selling Cost (30% of Works Cost) [Ref. working notes]		6.00
Cost of Sales		26.00
<b>(c)</b>		
Profit (10% on Cost)		2.60
Selling Price		28.60

**Illustration 2**

A work order for 100 units of a commodity has to pass through four different machines of which the machine hour rates are: Machine P – ₹ 1.25, Machine Q – ₹ 2.50, Machine R – ₹ 3 and Machine S – ₹ 2.25. Following expenses have been incurred on the work order – Materials ₹ 8,000 and Wages ₹ 500.

Machine - P has been engaged for 200 hours. Machine - Q for 160 hours, Machine - R for 240 hours and Machine - S for 132 hours.

After the work order has been completed, materials worth ₹ 400 are found to be surplus and are returned to stores.

Office overhead used to be 40% of works costs, but on account of all-round rise in the cost of administration, distribution and sale, there has been a 50% rise in the office overhead expenditure.

Moreover, it is known that 10% of production will have to be scrapped as not being upto the specification and the sale proceeds of the scrapped output will be only 5% of the cost of sale.

If the manufacturer wants to make a profit of 20% on the total cost of the work order, find out the selling price of a unit of commodity ready for sale.

**Solution:****Statement showing the selling price of a unit**

Particulars		Amount (₹)
Materials used (₹ 8,000 – ₹400)		7,600
Direct Wages		500
Prime Cost		8,100
Works Overhead at machine hour rate:		
Machine - P For 200 hours @ ₹ 1.25 per hour	250	
Machine - Q For 160 hours. @ ₹ 2.50 per hour	400	
Machine - R For 240 hours. @ ₹ 3 per hour	720	
Machine - S For 132 hours. @ ₹ 2.25 per hour	297	1,667
Works Cost		9,767
Administration Overhead at 60% of works cost		5,860
		15,627
Less: Sale proceeds of Scrap (5% of 10% of ₹ 15,627)		78
Total Cost of the work order		15,549
Profit at 20% of total Cost		3,110
Selling Price of 100 units		18,659
Selling Price of a unit		186.59

**Note:** It was known before that 10% of production will have to be scrapped, therefore, inputs must have been made taking this factor into consideration. No other adjustment is necessary except deducting the value of scrap from the cost of production.

**Illustration 3**

The data pertaining to Heavy Engineering Ltd. using are as follows at the end of 31.3.2018. Direct material ₹ 9,00,000; Direct wages ₹ 7,50,000; Selling and distribution overhead ₹ 5,25,000; Administrative overhead ₹ 4,20,000, Factory overhead ₹ 4,50,000 and Profit ₹ 6,09,000.



- (a) Prepare a cost sheet showing all the details.
- (b) For 2017-18, the factory has received a work order. It is estimated that the direct materials would be ₹ 12,00,000 and direct labour cost ₹ 7,50,000. What would be the price of work order if the factory intends to earn the same rate of profit on sales, assuming that the selling and distribution overhead has gone up by 15%? The factory recovers factory overhead as a percentage of direct wages and administrative and selling and distribution overheads as a percentage of works cost, based on the cost rates prevalent in the previous year.

**Solution:**

(a)

**Statement of Cost**

Particulars	Amount (₹)
Direct Materials	9,00,000
Direct Wages	7,50,000
Prime Cost	16,50,000
Factory Overheads (60% of wages)	4,50,000
Works Cost	21,00,000
Administration Overhead (20% of works cost)	4,20,000
Cost of Production	25,20,000
Selling & Distribution Overheads (25% of Works Cost)	5,25,000
Cost of Sales	30,45,000
Profit (1/5 of Cost)	6,09,000
Sales	36,54,000

(b)

**Estimated price of work order**

Particulars	Amount (₹)
Direct Materials	12,00,000
Direct Wages (or labour)	7,50,000
Prime Cost	19,50,000
Factory Overheads (60% of wages)	4,50,000
Works Cost	24,00,000
Administration Overhead (20% of works cost)	4,80,000
Cost of Production	28,80,000
Selling & Distribution Overheads (40% i.e., 25 % + 15% of Works Cost)	9,60,000
Total Cost	38,40,000
Profit (1/5 of Total Cost)	7,68,000
Estimated Sales price	46,08,000

**Illustration 4**

A manufacturing company is divided into three production departments – A, B and C. All production is to customers' orders. All orders are dissimilar and they go through all the three departments.

Manufacturing Costs for a given period were as follows:

Particulars	Dept A	Dept B	Dept C	Total
	Amount (₹)	Amount (₹)	Amount (₹)	Amount (₹)
Direct material				1,80,000
Direct labour	40,000	20,000	30,000	90,000
Indirect manufacturing costs	20,000	40,000	30,000	90,000

The cost of producing a particular order was determined as follows:

Particulars	Amount (₹)
Direct material	1,000
Direct Labour:	₹
Department A	120
Department B	280
Department C	200
Indirect manufacturing Costs	600
	2,200

The General Manager had a hazy idea that the jobs executed on orders of this nature are under-priced. So, the services of a firm of cost accountants, of which you are a member, have been acquired for a thorough investigation.

Can you detect, after a careful perusal of the limited available information, the fundamental fallacy of the company's method assuming that the direct labour cost is an acceptable basis for distributing indirect manufacturing costs?

Prepare a revised cost for order distributing indirect manufacturing costs in a manner you consider more correct than the company's procedure.

#### Solution:

The predominant fault is the adoption of a blanket rate for the distribution of the indirect manufacturing costs for all the three departments, i.e., 100% of total direct labour cost. This has been done despite of the fact that there are glaring differences of the direct labour cost of three departments. For calculating the revised cost of jobs, departmental rates based on indirect manufacturing cost percentage to direct labour costs are calculated:

Particulars	Departments		
	A	B	C
Indirect Mfg. Cost (₹) (a)	20,000	40,000	30,000
Direct Labour (₹) (b)	40,000	20,000	30,000
% of Mfg. Cost to Labour Cost $[(a/b) \times 100]$	50%	200%	100%

On the assumption that direct labour cost method is considered to be a reasonable method of absorption of overheads, it is quite possible that departmental application of overhead may be able to resolve the difficulty faced by the manager regarding the costing of the job given. On this basis the amended job cost sheet will be as under:

#### Revised Cost of Job

Particulars	Amount (₹)	Amount (₹)
Direct Materials (Given)		1,000
Direct Labour:		
Dept. A	120	
Dept. B	280	
Dept. C	200	600
		1,600
Indirect Manufacturing Cost: (Revised)		
Dept. A	50% of Direct Labour	60
Dept. B	200% of Direct Labour	560
Dept. C	100% of Direct Labour	200
Total Cost		820
		2,420

**Illustration 5**

A shop floor supervisor of a small factory presented the following cost for Job no.555 to determine selling price.

Particulars	Per unit (₹)
Materials	70
Direct Wages 18 hours at 2.5	45
Dept. X-8 hours	
Dept. Y-6 hours	
Dept. Z-4 hours	
Chargeable expenses (special stores items)	5
	120
Plus 33% Overheads	40
	160

Analysis of the Profit/Loss Account for 2016 shows the following

Particulars	Amount (₹)	Amount (₹)	Particulars	Amount (₹)	Amount (₹)
Materials		1,50,000	Sales		2,50,000
Direct Wages:					
Dept. X	10,000				
Dept. Y	12,000				
Dept. Z	8,000	30,000			
Special stores items		4,000			
Overheads:					
Dept. X	5,000				
Dept. Y	9,000				
Dept. Z	2,000	16,000			
		2,00,000			
Gross profit c/d		50,000			
		2,50,000	Gross profit b/d		2,50,000
Selling expenses		20,000			50,000
Net profit c/d		30,000			
		50,000			50,000

It is also noted that average hourly rates for the 3 departments, X, Y and Z are similar.

You are required:

- Draw up a job cost sheet;
- Calculate the entire revised cost using 2016 actual figures as basis;
- Add 20% to total cost to determine selling price.



**Solution:**

(a)

**Calculation of Departmental Overhead Rates**

Amount (₹)

Particulars	Departments		
	X	Y	Z
(i) Direct Wages	10,000	12,000	8,000
(ii) Rate of wages per hour	2.5	2.5	2.5
(iii) Hours (i ÷ ii)	4000	4800	3200
(iv) Actual Overheads	5000	9000	2000
(v) Department Overhead Rates per hour (iv ÷ iii)	1.250	1.875	0.625

(b)

**Revised job cost sheet**

Particulars			Amount (₹)
Materials			70
Labour:			
Dept. X	8 x 2.5	20	
Dept. Y	6 x 2.5	15	
Dept. Z	4 x 2.5	10	45
Direct Expenses			5
Prime Costs			120
Overheads:			
Dept. X	8 x 1.250	10.00	
Dept. Y	6 x 1.875	11.25	
Dept. Z	4 x 0.625	2.50	23.75
Total Cost			143.75
<b>(c)</b>			
Add: Profit 20%			28.75
Selling Price			172.50

**Illustration 6**

In a factory following the Job Costing Method, an abstract from the work in process as at 30th September, was prepared as under.

Amount (₹)

Job No.	Materials	Direct Labour	Factory Overheads Applied
115	1,325	400 hrs 800	640
118	810	250 hrs. 500	400
120	765	300 hrs 475	380
	<b>2,900</b>	<b>1,775</b>	<b>1,420</b>



Materials used in October were as follows:

		Amount (₹)
Material requisitions No.	Job no.	Cost
54	118	300
55	118	425
56	118	515
57	120	665
58	121	910
59	124	720
		3,535

A summary of Labour Hours deployed during October is as under:

JOB NO.	NUMBER OF HOURS	
	SHOP A	SHOP B
115	25	25
118	90	30
120	75	10
121	65	-
124	20	10
	275	75
Indirect Labour:		
Waiting for material	20	10
Machine breakdown	10	5
Idle time	5	6
Overtime premium	6	5
	316	101

A shop credit slip was issued in October, that material issued under requisition No.54 was returned back to stores as being not suitable. A material transfer note issued in October indicated that material issued under requisition No.55 for Job 118 was directed to Job 124.

The hourly rate in shop A per labour hour is ₹3 while at shop B it is ₹ 2 per hour. The factory overhead is applied at the same rate as in September; Jobs 115, 118 and 120 were completed in October.

You are asked to compute the factory cost of the completed jobs. It is practice of the management to put a 10% on the factory cost to cover administration and selling overheads and invoice the job to the customer on a total cost plus 20% basis what would be the invoice price of these three jobs?

**Solution:****Calculation of selling price of the Job**

Job No.	115	118	120
	Amount (₹)	Amount (₹)	Amount (₹)
<b>Costs in September:</b>			
Material	1,325	810	765
Labour	800	500	475
Overheads	640	400	380
Total (A)	2,765	1,710	1,620
<b>Costs in October:</b>			
Material	-	515	665
Labour			
(25 x 3)+(25 x 2)	125		
(90 x 3)+(30 x 2)		330	
(75 x 3)+(10 x 2)			245
Overheads (80% of Labour)	100	264	196
Total (B)	225	1,109	1,106
Total Factory Cost (A+B)	2,990	2,819	2,726
Add: Admn. Overheads' 10%	299.0	281.9	272.6
	3,289.0	3,100.9	2,998.6
Profit 20%	651.80	620.18	599.72
Selling Price	3,946.80	3,721.08	3,598.32

**5.2 BATCH COSTING****Meaning**

Batch Costing is that form of specific order costing under which each batch is treated as a cost unit and costs are accumulated and ascertained separately for each batch. Each batch consists of a number of like units.

**Basic Features**

- Each batch is treated as a cost unit.
- All costs are accumulated and ascertained for each batch.
- A separate Batch Cost Sheet is used for each batch and is assigned a certain number by which the batch is identified.
- The cost per unit is ascertained by dividing the total cost of a batch by the number of items produced in that batch.

**Applications**

Batch Costing is applied in those industries where the similar articles are produced in definite batches for internal consumption in the production of finished products or for sale to customers generally. It is generally applied in –

- Read made Garments Manufacturing Industries



- (b) Pharmaceutical/ Drug Industries
- (c) Spare parts and Components Manufacturing Industries
- (d) Toys Manufacturing Industries
- (e) Tyre and Tubes Manufacturing Industries

### Economic Batch Quantity (EBQ)

#### Meaning

Economic Batch Quantity refers to the optimum quantity batch which should be produced at a point of time so that the Set up & Processing Costs and Carrying Costs are together optimized.

#### Setting up & Processing Costs

The setting up and processing costs refer to the costs incurred for setting up and processing operations before the start of production of a batch. There is an inverse relationship between batch size and set up & processing costs.

Large the Batch size : Lower the set up costs because of few batches

Smaller the Batch Size : Higher the set up costs because of more batches

#### Carrying Costs

The carrying costs refer to the costs incurred in maintaining a given level of inventory. There is positive relationship between batch size and carrying costs.

Large the Batch size : Higher the carrying costs because of high average inventory

Smaller the Batch Size : Lower the carrying costs because of low average inventory

Trade off

The optimum quantity of batch which should be produced at a point of time determined after achieving a **trade off between set up costs and carrying costs**. Such batch size is known as EBQ because annual total cost of set up and carrying is minimum at this batch size.

#### FORMULA

$$\text{E.B.Q} = \sqrt{\frac{2AS}{C}}$$

Where, E.B.Q = Economic Batch Quantity  
A = Annual Demand  
S = Set up Cost per batch  
C = Carrying Costs per unit per year

#### Illustration 7

From the following information, calculate Economic Batch Quantity for a company using batch costing:

Annual Demand for the components	2400 units
Setting up cost per batch	₹ 100
Manufacturing cost per unit	₹ 200
Carrying cost per unit	6% p.a.

**Solution :**

$$EBQ = \sqrt{\frac{2AS}{C}} = \sqrt{\frac{2 \times 2,400 \times 100}{6\% \text{ of } 200}} = 200 \text{ Units}$$

**Illustration 8**

A customer has been ordering 90,000 special design metal columns at the columns at the rate of 18,000 per order during the past years. The production cost comprises ₹120 for material, ₹ 60 for labour and ₹20 for fixed overheads. It costs ₹ 1,500 to set up for one run of 18,000 column and inventory carrying cost is 15% since this customer may buy at least 5000 columns this year, the company would like to avoid making five different production runs. Find the most economic production run.

**Solution :**

Economic Production Run

$$= \sqrt{\frac{2 \times \text{Annual Output} \times \text{Setup Cost Per Production Run}}{\text{Inventory Carrying Cost per unit p.a.}}}$$

$$= \sqrt{\frac{2 \times 90,000 \times 1,500}{15\% \text{ of } 200(120 + 60 + 20)}} = 3,000 \text{ units}$$

**Illustration 9**

AB Ltd. is committed to supply 24,000 bearings per annum to CD Ltd. On a steady basis. It is estimated that it costs 10 paise as inventory holding cost per bearing per month and that the set-up cost per run of bearing manufacture is ₹ 324.

- What would be the optimum run size for bearing manufacture?
- What is the minimum inventory holding cost at optimum run size?
- Assuming that the company has a police of manufacturing 6000 bearing per run, how much extra costs would the company be incurring as compared to the optimum run suggested in (a)?

**Solution :**

$$(a) \text{ Optimum production Run Size (Q)} = \sqrt{\frac{2AS}{C}}$$

Where, A = No. of units to be produced within one year = 24,000 (units) bearing

O = Set-up cost per production run = ₹ 324

C = Carrying cost per unit per annum =  $0.10 \times 12 = ₹ 1.2$

$$= \sqrt{\frac{2 \times 24,000 \times 324}{1.2}} = 3,600 \text{ units (bearing)}$$

(b) Minimum inventory Holding Cost, if run size is 3600 bearings

= Average inventory x carrying cost per unit

$$= (3600/2) \times (.10 \times 12) = ₹ 2160$$



(c) Statement showing Total Cost at Production Run sizes of 3600 and 6000 bearings

A.	Annual requirements	24000	24000
B.	Run size	3600	6000
C.	No. of runs (A/B)	6.667	4
D.	Set up cost per run	₹ 324	₹ 324
E.	Total set up cost (C X D)	₹ 2160	₹ 1296
F.	Average inventory( B/2)	1800	3000
G.	Carrying cost per unit p.a.	1.20	1.20
H.	Total carrying cost ( F x G)	2160	3600
I.	Total cost (E + H)	4320	4896

Extra cost incurred , if run size is of 6000 = ₹ 4896 – ₹ 4320 = ₹ 576

**Illustration 10**

Component 'Gold' is made entirely in cost centre 100. Material cost is 6 paise per component and each component takes 10 minutes to produce. The machine operator is paid 72 paise per hour, and machine hour rate is ₹ 1.50. The setting up of the machine to produce the component 'Gold' takes 2 hours 20 minutes.

On the basis of this information, prepare a cost sheet showing the production and setting up cost, both in total and per component, assuming that a batch of :

- (a) 10 components,
- (b) 100 components, and
- (c) 1000 components is produced.

**Solution :**

**Cost Sheet Component 'Gold' Amount (₹)**

Particulars	Batch Size					
	10 components		100 components		1000 components	
	Total	Per component	Total	Per component	Total	Per component
A. Setting up Cost:						
Machine Operators wages (2 hours 20minutes @ ₹72 p.h)	1.68	0.168	1.68	0.0168	1.68	0.00168
Overheads 2 hours 20minutes @ ₹1.50 p.h)	3.50	0.350	3.50	0.0350	3.50	0.00350
B. Production Cost:						
Material Cost @ ₹0.06 per component	0.60	0.060	6.00	0.0600	60.00	0.06000
Machine Operators Wages [(Refer to Working Note (i))]	1.20	0.120	12.00	0.1200	120.00	0.12000
Overheads [(Refer to Working Note (ii))]	2.50	0.250	25.00	0.2500	250.00	0.25000
C. Total Cost : (A + B)	9.48	0.948	48.18	0.4818	435.18	0.43518

**Working Notes:**

	10 Components	100 Components	1000 Components
(i) Operators Wages Time taken in minutes by machine operators and machine @10minutes per component Operators Wages @ ₹ 0.72 per hour (₹)	100 [100/60 x 0.72]=1.2	1000 [1000/60 x 0.72]=12	10000 [10000/60 x 0.72]=120
(ii) Overhead expenses Total overhead expenses @ ₹ 1.50 per Machine hour	2.50 [100/60 x ₹ 1.50]	25.00 [1000/60 x ₹1.50]	250.00 [10000/60 x ₹1.50]

### 5.3 CONTRACT COSTING

Contract Costing or Terminal Costing as it is often termed, is a variant of the job costing system, which is applied in businesses engaged in building or other construction work. The jobs are usually the contracts entered into with the customers. As the number of such contracts handled at a time by a business may not be usually large, Contract Costing is comparatively simpler in operation than job costing system. The basic principles applied in Contract Costing are the same as those used in job costing except that these are modified to suit the particular requirements of the contracts.

#### Differences between Job costing and Contract costing

- While the number of jobs in hand at any time in a concern may be large, only a few contracts may be undertaken at a time.
- The accumulation, analysis, apportionment, allocation and control of costs is simplified in Contract Costing.
- Most of the expenses are chargeable direct to the Contract Account. Direct allocation to such an extent is not possible in job costing.
- As contracts may run for long periods, there arises the problem of assessment and crediting of profits on incomplete contracts at the end of the accounting period.

Contract Costing is a type of costing used in constructional activities such as construction of buildings, roads, bridges etc. The person who takes contract for a price is called the **Contractor** and the person from whom it is taken is called the **Contractee**. We are mainly concerned with the books of the contractor. To find out profit earned or loss incurred on the contract, the contractor prepares a nominal account in his books called 'Contract Account'. In this account, all the expenses incurred by the contractor are debited and the income i.e mainly work certified is credited; the difference represents profit or loss.

The items generally debited are materials, wages, establishment expenses & other expenses. Depreciation of assets used in the contract will also be debited, but unlike in other types of accounts it is customary in Contract Accounts to debit the opening balance of the assets and credit the closing balance of the same instead of depreciation, wherever it is convenient to do so. Amounts credited are work-in-progress, which consists of work certified and cost of work uncertified and any scrap of materials etc. Further some special items which are discussed here under will also be taken care of.

The contracts run for or number of years; however it is necessary to find out the profit or loss at the end of every year. The profit earned on a Contract Account is primarily called **Notional Profit** and a portion



of which would be kept on reserve against contingencies. The profit to be transferred to Profit & Loss Account out of notional profit is ascertained by taking into consideration the degree of completion of the work, cash received etc.

**Some special items under contract accounting are explained below:**

**(i) Sub-Contract**

Sub-contracting, usually of a part of the work, is another essential feature which we frequently come across in contract work. Sub-contracting may be necessary under the following circumstances:

- (a) Work of a specialized nature for which facilities are not internally available within the concern is offered to a sub-contractor.
- (b) It may be advantageous to get a part or component from outside, if it is costlier to manufacture it.
- (c) Consideration of opportunity cost; the management may not like to invest capital which may be utilized for other more profitable lines.
- (d) The capacity of the firm may be limited and in order to keep time schedule, work may be speeded by offering it to sub-contractors.

The payments made to sub-contractors are charged in totals to the concerned Contract Account as direct expense and no detailed records or break-up of the sub-contract amount is necessary for cost purposes.

**(ii) Surveyor's Certificate and Retention Money**

In the case of contracts running for long periods of time, it is customary for the contractor's firm to get 'on account' payments against the portion of contract completed. The amount received depends upon the extent of work certified by the technical assessor i.e. on the surveyor's certificates, as these are called. Normally such payments are not received to the full extent of the work completed but a small percentage is held back as retention money, payable on completion of the contract. The retention money is a sort of safeguard available to the contractee in case the contractor is not able to fulfill one or more of the conditions laid down in the contract.

**(iii) Defective Work**

Defective work will not evidently be paid for by the contractee but the cost of such defective work should be charged to the Contract Account. Sometimes, rectification of the defective work is required to be made at the contractor's cost; the cost of such rectification should also be charged to the Contract Account but shown separately.

**(iv) Escalation Clause**

Escalation clauses are often provided in contracts as safeguards against any likely changes in price or utilisation of material and labour. Such a clause in a contract would provide that in the event of a specified contingency happening, the contract price would be suitably enhanced. This clause is particularly necessary where the price of certain raw materials are likely to rise, where labour rates are anticipated to increase, or where the quantity of material or labour time cannot be properly assessed or estimated unless the work has sufficiently advanced. There may also be '**De-escalation or Reserve Clause**' to provide for any future decrease in price etc. so that the benefit may be passed on to the contractee.

**(v) Work-in-progress**

In Contract Accounts, the value of the work-in-progress consists of:-

- (a) the cost of work completed, both certified and uncertified,
- (b) the cost of work not yet complete, and
- (c) the amount of profit taken as credit.





In the Balance Sheet, the work-in-progress is usually shown under two heads, viz. certified and uncertified. The cost of work completed and certified and the profit credited will appear under the head 'certified' work-in-progress, while the completed work not yet certified and the cost of labour, material and expenses of work which has not reached the stage of completion are shown under the head 'uncertified' work-in-progress.

#### (vi) Profit on incomplete contracts

For the purpose of finding out the portion of the profit out of notional profit to be transferred to Profit and Loss Account, the contracts are divided in the following manner:-

##### (A) Contracts which have just commenced

In this case no portion of the notional profit shall be transferred to Profit and Loss Account and the entire amount is kept as reserve. There are no hard and fast rules to determine that a particular contract is just commenced or reasonably advanced or almost complete. However, as per general norms, the contracts in which less than 1/4<sup>th</sup> work is done are regarded as the contracts which have just commenced.

##### (B) Contracts which have reasonably advanced

In this case the profit to be transferred to Profit and Loss Account out of notional profit is based on the degree of completion of the contract. The degree of completion of the contract can be found out by comparing work certified and the contract price.

- If the degree of the completion of the contract is less than or equal to 1/4<sup>th</sup> no portion of the notional profit shall be transferred to Profit and Loss Account and the entire amount would be kept as reserve.
- If the degree of completion of work is ( $> 1/4$  and  $< 1/2$ ), 1/3 of the notional profit shall be transferred to Profit and Loss Account and the remaining amount would be kept as reserve.
- If the degree of completion of work is more than or equal to 1/2, 2/3<sup>rd</sup> of the notional profit shall be transferred to Profit and Loss Account and the remaining amount would be kept as reserve.

The profit so arrived in the above manner shall further be reduced in the ratio of cash received to work certified. Thus, the formula is as follows:

$$\text{(Notional Profit} \times \frac{2}{3} \text{ or } \frac{1}{3} \text{ (as the case may be) } \times \frac{\text{(Cash received)}}{\text{(Work certified)}}$$

##### (C) Contracts which are almost complete

In this case the portion of the profit to be transferred to Profit and Loss Account is calculated by using the estimated total profit which is ascertained by subtracting the total cost to date and the additional cost to complete the contract from the contract price. The different formulas for such computations of profit are as follows:-

- Estimated Profit  $\times \frac{\text{(Work certified)}}{\text{(Contract price)}}$
- Estimated Profit  $\times \frac{\text{(Work certified)}}{\text{(Contract price)}} \times \frac{\text{(Cash received)}}{\text{(Work certified)}}$
- Estimated Profit  $\times \frac{\text{(Total cost to date)}}{\text{(Total cost)}}$
- Estimated Profit  $\times \frac{\text{(Total cost to date)}}{\text{(Total cost)}} \times \frac{\text{(Cash received)}}{\text{(Work certified)}}$



### Recording of Contract Costs

#### Material Cost

All materials supplied from the stores or purchased directly for the contract are debited to the concerned contract account.

Contract Account (Contract No:) .....Dr.

To Stores Ledger Control A/c (Issued from stores) or

To Cost Ledger Control A/c (Direct purchase)

In the case of transfer of excess material from one contract to another, costs of these excess materials are adjusted on the basis of Material Transfer Note.

Contract Account (Contract No. ABC) .....Dr.

To Contract Account (Contract No. XYZ)

In case the return of surplus materials appears uneconomical on account of high cost of transportation, the same is sold and the concerned contract account is credited with the price realised. Any loss or profit arising therefrom is transferred to the Costing Profit and Loss Account.

Cost Ledger Control A/c.....Dr.

Costing Profit & Loss A/c (Loss).....Dr.

To Contract A/c

To Costing Profit & Loss A/c (Profit)

Any loss of materials due to theft or destructions etc. is transferred to the Costing Profit and Loss Account.

Costing Profit & Loss A/c .....Dr.

To Contract A/c

If any stores items are used for manufacturing tools, the cost of such stores items are charged to the work expenses account.

Works Expenses A/c..... Dr.

To Stores Ledger Control A/c

(With amount of stores used for works)

Contract A/c.....Dr.

To Works Expenses

(With amount of works used in the contract)

If the contractee has supplied some materials without affecting the contract price, no accounting entries will be made in the contract account, only a note may be given about it.

#### Employee (Labour) Cost

Workers employed on the site of the contract are regarded as direct employees (irrespective of the nature of the task performed) and the wages paid to them are charged to the concerned contract directly. If an employee is engaged concurrently in other contract also then the total wages paid is apportioned to the contracts on some reasonable basis, usually on time basis.



Contract A/c.....Dr.  
 To Works Expenses

### Direct Expenses

Direct expenses (if any) are directly charged to the concerned contract account.

Contract A/c.....Dr.  
 To Direct Expenses

### Indirect Expenses

Indirect expenses (such as expenses of engineers, surveyors, supervisors, corporate office etc.) may be distributed over several contracts on certain reasonable basis as overheads.

Contract A/c.....Dr.  
 To Overheads A/c

### Plant and Machinery

The value of the plant in a contract may be either debited to contract account and the written down value thereof at the end of the year entered on the credit side for closing the contract account, or only a charge (depreciation) for use of the plant may be debited to the contract account.

Contract A/c.....Dr.  
 To Plant and Machinery A/c (with cost)  
 Plant and Machinery A/c (with WDV).....Dr.  
 To Contract A/c  
 Or

Contract A/c.....Dr.  
 To Depreciation on Plant and Machinery A/c

### Sub-Contract

Sub-contract costs are also debited to the Contract Account

Contract A/c.....Dr.  
 To Cost of Sub-Contract A/c

### Extra work

The extra work amount payable by the contractee should be added to the contract price. If extra work is substantial, it is better to treat it as a separate contract. If it is not substantial expenses incurred should be debited to the contract account as "cost of Extra work".

### Illustration 11

A firm of Builders, carrying out large contracts kept in contract ledger, separate accounts for each contract on 30th June, 2017, the following were shown as being the expenditure in connection with Contract No. 555.



	Amount (₹)
Materials purchased	1,16,126
Materials issued from stores	19,570
Plant, which has been used on other contracts	25,046
Additional plant	7,220
Wages	1,47,268
Direct expenses	4,052
Proportionate establishment expenses	17,440

The contract which had commenced on 1st February, 2017 was for ₹ 6,00,000 and the amount certified by the Architect, after deduction of 20% retention money, was ₹ 2,41,600 the work being certified on 30th June, 2017. The materials on site were ₹ 19,716. A contract plant ledger was also kept in which depreciation was dealt with monthly the amount debited in respect of that account is ₹ 2260. Prepare Contract Account showing profit on the contract.

**Solution:**

Dr.		Contract Account		Cr.	
Particulars	Amount (₹)	Particulars	Amount (₹)		
To, Materials purchased A/c	1,16,126	By, Work in progress A/c			
To, Material issued A/c	19,570	- Work certified		3,02,000	
To, Depreciation A/c	2,260				
To, Wages A/c	1,47,268	By, Material stock A/c		19,716	
To, Direct expenses A/c	4,052				
To, Proportionate estab. expenses A/c	17,440				
To, P & L A/c [ $15,000 \times \frac{2}{3} \times \frac{4}{5}$ ]	8,000				
To, Reserve c/d	15,000				
	3,21,716				3,21,716

**Illustration 12**

A contractor has undertaken a construction work at a price of ₹ 5,00,000 and begun the execution of work on 1st January, 2016. The following are the particulars of the contract up to 31st December, 2016.

Particulars	Amount (₹)	Particulars	Amount (₹)
Machinery	30,000	Overheads	8,252
Materials	1,70,698	Materials returned	1,098
Wages	1,48,750	Work certified	3,90,000
Direct expenses	6,334	Cash received	3,60,000
Uncertified work	9,000	Materials on 31.12.2016	3,766
Wages outstanding	5,380		
Value of plant on 31.12. 2016	22,000		



It was decided that the profit made on the contract in the year should be arrived at by deducting the cost of work certified from the total value of the architects certificate, that 1/3 of the profit so arrived at should be regarded as a provision against contingencies and that such provision should be increased by taking to the credit of Profit and Loss Account only such portion of the 2/3rd profit, as the cash received to the work certified.

**Solution:**

Dr.	Contract Account		Cr.
Particulars	Amount (₹)	Particulars	Amount (₹)
To, Machinery A/c	30,000	By, Plant & Machinery A/c	22,000
To, Materials A/c	1,70,698	By, Materials returned A/c	1,098
To, Wages incl. outstanding A/c	1,54,130	By, Materials on hand A/c	3,766
To, Direct Expenses A/c	6,334	By, W.I.P A/c	
To, Overheads A/c	8,252	Work certified	3,90,000
To, P & L A/c	34,738	Work uncertified	<u>9,000</u>
To, Reserve c/d	21,712		3,99,000
	<b>4,25,864</b>		<b>4,25,864</b>

**Illustration 13**

A contractor commenced the work on a particular contract on 1st April, 2016 he usually closes his books of accounts for the year on 31st December of each year. The following information is revealed from his costing records on 31st December, 2016.

	Amount (₹)
Materials sent to site	43,000
Jr. Engineer	12,620
Labour	1,00,220

A machine costing ₹ 30,000 remained in use on site for 1/5th of year. Its working life was estimated at 5 years and scrap value at ₹ 2,000

A supervisor is paid ₹ 2,000 per month and had devoted one half of his time on the contract.

All other expenses were ₹14,000 the materials on site were ₹ 2,500.

The contract price was ₹ 4,00,000. On 31st December, 2016 2/3rd of the contract was completed however, the architect gave certificate only for ₹ 2,00,000. On which 80% was paid. Prepare Contract Account.



**Solution:**

**Contract Account**

Dr.

Cr.

Particulars	Amount (₹)	Particulars	Amount (₹)
To, Material A/c	43,000	By, W.I.P A/c	
To, Jr. Engineer A/c	12,620	Work certified	2,00,000
To, Labour A/c	1,00,220	Work uncertified	<u>*44,365</u>
To, Dep. On plant A/c $[(30,000-2,000)/5] \times 1/5$	1,120	By, Material at site	2,500
To, Supervisor (2,000 x 9 x 1/2)	9,000		
To, Other expenses A/c	14,000		
To, P & L A/c	35,683		
To, Reserve c/d	31,222		
	<u>2,46,865</u>		<u>2,46,865</u>

**Working notes:**

Work uncertified:

For 2/3<sup>rd</sup> - ₹1,77,460

For 1/6<sup>th</sup> - ? (2/3 - 1/2 = 1/6)

\*  $[(1,77,460 \div 2/3) \times 1/6] = ₹44,365$

**Illustration 14**

The following figures are supplied to you by contractor for the year ending 31st December, 2016.

Particulars	Amount (₹)
Work-in-Progress on 31-12-2015	₹ 85,000
Less: Cash received from contractee	<u>₹ 55,000</u>
<b>During the year:</b>	
Wages	8,500
Materials bought	6,000
Working expenses	1,500
Materials issued from stores	10,500
Administrative expenses (₹250 are chargeable to Profit and Loss Account)	1,250
Plant	2,500
Material returned to supplier	450
Material returned to stores	550
Work certified	15,000
Contracts finished	22,500
Profits taken upon contracts	11,500
Advances from contractee	<u>40,000</u>



Prepare Contract Ledger Accounts, and the total contractee's and show the work-in-progress as it would appear in the Balance sheet.

**Solution:**

Dr.		Contract Account		Cr.	
Particulars	Amount (₹)	Particulars		Amount (₹)	
To, Work-in-Progress A/c	85,000	By, W.I.P A/c			
To, Wages A/c	8,500	Work certified	15,000		
To, Materials A/c	6,000	Work uncertified	<u>88,000</u>	1,03,000	
To, Materials A/c	10,500	By, Material returned (supplier)		450	
To, Working Expenses A/c	1,500	By, Material returned (stores)		550	
To, Administration Expenses A/c	1,000	By, Contractee A/c		22,500	
To, Plant	2,500				
To, P & L A/c	11,500				
	1,26,500			1,26,500	

Dr.		Contractee Account		Cr.	
Particulars	Amount (₹)	Particulars		Amount (₹)	
To, Contract A/c	22,500	By, Balance b/d		55,000	
To, Balance c/d	72,500	By, Cash A/c		40,000	
	95,000			95,000	

**Balance Sheet as on .....**

Liabilities	Amount (₹)	Assets	Amount (₹)
		W.I.P	1,03,000
		(-) Cash received	72,500
			30,500

**Illustration 15**

The information given under has been extracted from the books of a contractor relating to contract for ₹3,75,000.

	I YEAR	II YEAR	III YEAR
	Amount (₹)	Amount (₹)	Amount (₹)
Materials	45,000	55,000	31,500
Direct Expenses	1,750	6,250	2,250
Indirect expenses	750	1,000	---
Wages	42,500	57,500	42,500
Total work certified	87,500	2,82,500	3,75,000
Uncertified work	---	5,000	---
Plant	5,000	---	---

The value of plant at the end of I year was ₹4,000 at the end of II year ₹2,500 and at the end of III year it was ₹1,000. It is customary to pay 90% in cash of the amount of work certified. Prepare the contract Account and show how the figures would appear in the balance sheet.



**Solution:**

Dr.	Contract Account		Cr.
Particulars	Amount (₹)	Particulars	Amount (₹)
Ist Year			
To, Materials A/c	45,000	By, W.I.P A/c	
To, Direct Expenses A/c	1,750	Work certified	87,500
To, Indirect Expenses A/c	750	Work uncertified	Nil
To, Wages A/c	42,500	By, Plant A/c	4,000
To, Plant A/c	5,000	By, P & L A/c	3,500
	95,000		95,000
IIInd Year			
To, Work in progress A/c	87,500	By, W.I.P A/c	
To, Materials A/c	55,000	Work certified	2,82,500
To, Direct Expenses A/c	6,250	Work uncertified	<u>5,000</u>
To, Plant A/c	4,000	By, Plant A/c	2,500
To, Wages A/c	57,500		
To, Indirect Expenses A/c	1,000		
To, P & L A/c	47,250		
To, Reserve c/d	31,500		
	2,90,000		2,90,000
IIIrd Year			
To, Work in progress A/c	2,87,500	By, Reserve b/d	31,500
To, Plant A/c	2,500	By, Contractee A/c	3,75,000
To, Materials A/c	31,500	By, Plant A/c	1,000
To, Direct expenses A/c	2,250		
To, Wages A/c	42,500		
To, P & L A/c	41,250		
	4,07,500		4,07,500

**Balance Sheet as on .....**

Liabilities	Amount (₹)	Assets	Amount (₹)
Ist Year		Work in progress	87,500
	----	(-) Cash received (90%)	<u>78,750</u>
		Plant	4,000
IIInd Year		Work in progress	2,87,500
	----	(-) cash received (90%)	<u>2,54,250</u>
			33,250
		(-) Reserve	31,500
IIIrd Year		Plant	2,500



**Illustration 16**

A firm of engineers undertook three contracts beginning on 1st Jan, 1st May and 1st August 2015. Their accounts on 30th November, 2015 showed the following position:

Particulars	Contract I	Contract II	Contract III
	Amount (₹)	Amount (₹)	Amount (₹)
Contract price	80,000	54,000	60,000
Materials	14,400	11,600	4,000
Wages	22,000	22,500	2,800
General expenses	800	550	200
Cash received for work certified	30,000	24,000	5,400
Work certified	40,000	32,000	7,200
Work uncertified	1,200	1,600	400
Wages outstanding	700	750	350
General expenses outstanding	150	100	50
Plant installed	4,000	3,200	2,400
Materials on hand	800	800	400

On the respective dates of the contracts, the plant was installed depreciation thereon being taken at 15% p.a. You are required to prepare accounts in the Contract Ledger.

**Solution:**

Dr.	Contract Account			Cr.	Amount (₹)		
	I	II	III		I	II	III
To, Materials A/c	14,400	11,600	4,000	By, W.I.P A/c			
To, Wages (incl. o/s) A/c	22,700	23,250	3,150	Work certified	40,000	32,000	7,200
To, Gen Expenses A/c	950	650	250	Work uncertified	1,200	1,600	400
To, Dep. On plant A/c (4,000 x 15% x 11/12)	550	280	120	By, Material on hand A/c	800	800	400
(3,200 x 15% x 7/12)				By, P & L A/c	--	1,380	--
(2,400 x 15% x 4/12)							
To, Notional profit	3,400	--	480				
	42,000	35,780	8,000		42,000	35,780	8,000
To, P & L A/c (3,400 x 2/3 x 3/4)	1,700	--	--	By, Notional profit	3,400	--	480
To, Reserve c/d	1,700	--	480				
	3,400	--	480		3,400	--	480



**Illustration 17**

The following is the Trial Balance of Premier Construction Company, engaged on the execution of contract No.747, for the year ended 31st December, 2015.

<b>Contractee's Account</b>	Amount (₹)	Amount (₹)
Amount received		3,00,000
Buildings	1,60,000	
Creditors		72,000
Bank Balance	35,000	
Capital Account		5,00,000
Materials	2,00,000	
Wages	1,80,000	
Expenses	47,000	
Plant	2,50,000	
	8,72,000	8,72,000

The work on Contract No.747 was commenced on 1st January, 2015 materials costing ₹ 1,70,000 were sent to the site of the contract but those of ₹ 6,000 were destroyed in an accident. Wages of ₹1,80,000 were paid during the year. Plant with a cost of ₹ 2 lakhs was used from 1st January to 30th September and was then returned to the stores. Materials of the cost of ₹ 4,000 were at site on 31st December, 2012.

The contract was for ₹ 6,00,000 and the contractee pays 75% of the work certified. Work certified was 80% of the total contract work at the end of 2012. Uncertified work was estimated at ₹ 15,000 on 31st December, 2015.

Expenses are charged to the contract at 25% of wages. Plant is to be depreciated at 10% for the entire year.

**Solution:**

<b>Dr.</b>	<b>Contract Account</b>		<b>Cr.</b>
<b>Particulars</b>	Amount (₹)	<b>Particulars</b>	Amount (₹)
To, Materials A/c	1,70,000	By, Costing P & L A/c	6,000
To, Wages A/c	1,80,000	By, Materials returned	4,000
To, Dep. on plant A/c	20,000	By, W.I.P A/c	4,95,000
[2,50,000 x 9/12 x 10/100]		Work certified	4,80,000
[50,000 x 3/12 x 10/100]		Work uncertified	<u>15,000</u>
To, Expenses (25%)	45,000		
To, P & L A/c	45,000		
To, Reserve c/d	45,000		
	5,05,000		5,05,000



Dr.		Profit & Loss Account		Cr.	
Particulars	Amount (₹)	Particulars	Amount (₹)		
To, Contract A/c	6,000	By, Profit from Contract A/c	45,000		
To, Dep. on Plant [2,00,000 x 10% x 3/12]	5,000				
To, Expenses (47,000 – 45,000) A/c	2,000				
To, Net Profit	32,000				
	<b>45,000</b>				<b>45,000</b>

**Balance Sheet as on .....**

Liabilities	Amount (₹)	Assets	Amount (₹)
To, Capital A/c	5,00,000	By, W.I.P A/c	4,95,000
To, P & L A/c	32,000	(-) Cash received	<u>3,00,000</u>
To, Creditors A/c	72,000		1,95,000
		(-) Reserve	<u>45,000</u>
		By, Buildings A/c	1,60,000
		By, Bank A/c	35,000
		By, Material stock A/c	34,000
		By, Plant A/c	2,25,000
	<b>6,04,000</b>		<b>6,04,000</b>

**Illustration 18**

A company of builders took to a multi-storied structure for ₹ 40,00,000 estimating the cost to be ₹ 36,80,000. At the end of the year, the company had received ₹ 14,40,000 being 90% of the work certified; work done but not certified was ₹40,000. Following expenditure were incurred.

	₹
Materials	4,00,000
Labour	10,00,000
Plant	80,000

Materials costing ₹ 20,000 were damaged. Plant is considered as having depreciated at 25%.

Prepare Contract Account and show all the possible figures that can reasonably be credited to Profit and Loss Account.

**Solution:**

Dr.		Contract Account		Cr.	
Particulars	Amount (₹)	Particulars	Amount (₹)		
To, Material	4,00,000	By, Costing P & L A/c	20,000		
To, Labour	10,00,000	By, W.I.P A/c			
To, Depreciation	20,000	Work certified	16,00,000		
To, Notional Profit	2,40,000	Work uncertified	40,000		16,40,000
	<b>16,60,000</b>				<b>16,60,000</b>

- (i)  $3,20,000 \times (1,420/3,680) = 1,23,478$   
(ii)  $3,20,000 \times (1,420/3,680) \times 90/100 = 1,11,130$   
(iii)  $3,20,000 \times 16/40 = 1,28,000$   
(iv)  $3,20,000 \times (16/40) \times (90/100) = 1,15,200$

**Illustration 19**

The following Trial Balance was extracted on 31st December, 2015 from the books of Swastik Co. Ltd contractors:

	Dr.	Cr.
<b>Share Capital:</b>		
Shares of ₹10 each		3,51,800
P&L A/c on 1.1. 2015		25,000
Provision for Dep. on Machinery		63,000
Cash received on account Contract - 7		12,80,000
Creditors		81,200
Land and Buildings (Cost)	74,000	
Machinery (Cost)	52,000	
Bank	45,000	
<b>Contract 7:</b>		
Materials	6,00,000	
Direct Labour	8,30,000	
Expenses	40,000	
Machinery on site (Cost)	1,60,000	
	18,01,000	18,01,000

Contract 7 was begun on 1st Jan 2015. The contract price is ₹ 24,00,000 and the customer has so far paid ₹ 12,80,000 being 80% of the work certified.

The cost of the work done since certification is estimated at ₹ 16,000. On 31st December, 2015, after the above Trial Balance was extracted machinery costing ₹ 32,000 was returned to stores, and materials then on site were value at ₹27,000.

Provision is to be made for direct labour due ₹6,000 and for depreciation of all machinery at 12 1/2 % on cost.

You are required to prepare:

- The Contract Account;
- A Statement of Profit, if any, to be properly credited to profit and loss account for 2015 and
- The Balance Sheet of Swastik Co. Ltd as on 31st December.

**Solution:**

Dr.		Contract Account	Cr.	
Particulars	Amount (₹)	Particulars	Amount (₹)	
To, Material A/c	6,00,000	By, W.I.P A/c		
To, Direct labour A/c	8,36,000	Work certified	16,00,000	16,16,000
To, Expenses A/c	40,000	Work uncertified	<u>16,000</u>	
To, Dep. on machinery A/c	20,000	By, Material at site A/c		27,000
To, P & L A/c	78,400			
To, Reserve c/d	68,600			
	<b>16,43,000</b>			<b>16,43,000</b>

Dr.		Profit and Loss Account		Cr.	
Particulars	Amount (₹)	Particulars	Amount (₹)		
To, Dep. on plant A/c	6,500	By, Balance b/d	25,000		
To, Net profit	96,900	By, Profit from contract A/c	78,400		
	1,03,400		1,03,400		

**Balance Sheet as on .....**

Liabilities	Amount (₹)	Assets	Amount (₹)
Share Capital	3,51,800	Machinery	2,12,000
P & L A/c	96,900	(-) Provision	63,000
Creditors	81,200	C.Year Depreciation	<u>26,500</u>
O/s Labour	6,000		1,22,500
		W.I.P	16,16,000
		(-) Cash received	<u>12,80,000</u>
			3,36,000
		(-) Reserve	<u>68,600</u>
			2,67,400
		Land & Buildings	74,000
		Bank	45,000
		Stock of materials	27,000
	5,35,900		5,35,900

**Illustration 20**

Kapur Engineering Company undertakes long term contract which involves the fabrication of pre stressed concrete block and the reaction of the same on consumer's life.

The following information is supplied regarding the contract which is incomplete on 31st March, 2017

Cost Incurred:	Amount (₹)
Fabrication cost to date:	
Direct materials	2,80,000
Direct Labour	90,000
Overheads	<u>75,000</u>
	4,45,000
Erection cost to date	<u>15,000</u>
Total	<u>4,60,000</u>
Contract price	8,19,000
Cash received on account	6,00,000
Technical estimate of work completed to date:	
Fabrication: Direct materials	80%
Direct labour and overheads	75%
Erection	25%

You are required to prepare a statement for submission to the management indicating

- The estimated profit on the completion of the contract;
- The estimated profit to date on the contract.

**Solution:****Statement showing computation of profit on completion of contract and profit to date:** Amount (₹)

Particulars	Incurred to date	To be incurred	Total
Material	2,80,000	70,000	3,50,000
Labour	90,000	30,000	1,20,000
Overheads	75,000	25,000	1,00,000
Erection	15,000	45,000	60,000
	4,60,000	1,70,000	6,30,000
Profit *			* 1,89,000
Contract Price			8,19,000

$$\begin{aligned} \text{Profit to date} &= 1,89,000 \times (6,00,000 / 8,19,000) = 1,38,461 && \text{(or)} \\ &= 1,89,000 \times (4,60,000 / 6,30,000) = 1,38,000 \end{aligned}$$

**Illustration 21**

The following particulars are obtained from the books of Vinay Construction Ltd. as on March, 2017.

₹

Plant and equipment at cost 4,90,000

Vehicles at cost 2,00,000

Details of contract with remain uncompleted as on 31-3-2017.

Particulars	Contract nos.		
	V.29	V.24	V.25
	(₹lacs)	(₹lacs)	(₹lacs)
Estimated final sales value	8.00	5.60	16.00
Estimated cost	6.40	7.00	12.00
Wages	2.40	2.00	1.20
Materials	1.00	1.10	0.44
Overheads (excluding dep.)	1.44	1.46	0.58
	4.84	4.56	2.22
Value certified by architects	7.20	4.20	2.40
Progress payments received	5.00	3.20	2.00

Depreciation of plant and Equipment and Vehicle should be charged at 20% to the three contracts in proportion to work certified. You are required to prepare statements showing contract-wise and total.

- Profit/loss to be taken to the P & L A/c for the year ended 31st March, 2017.
- Work-in-progress as would appear in the Balance Sheet as at 31-03-2017.

**Solution:**

(₹ in Lacs)

Dr. Contract Account				Cr.			
Particulars	V.29	V.24	V.25	Particulars	V.29	V.24	V.25
To, Expenses other than depreciation	4.84	4.56	2.22	By, W.I.P A/c			
To, Depreciation *	0.72	0.42	0.24	Work certified	7.20	4.20	2.40
To, Notional profit	1.64	--	--	By, P & L A/c	--	0.78	0.06
	7.20	4.98	2.46		7.20	4.98	2.46
To, P & L A/c	*1.00	--	--	By Notional profit	1.64	--	--
To, Reserve A/c	0.64	--	--				
	1.64	--	--		1.64	--	--

\* V.29  $\Rightarrow [6,90,000 \times 20\% \times 7.2/13.8] = 0.72$  and similarly for V.24 & V.25 also.

Profit to be transfer to Profit and Loss A/c = EP x CR/CP =  $1.60 \times 5.00/8 = 1^*$

**Illustration 22**

A company is manufacturing building bricks and fire bricks. Both the products require two processes. Brick forming and Heat treatment. The requirements for the two bricks are:

	BUILDING BRICKS	FIRE BRICKS
Forming per 100 bricks	3 hrs.	2 hrs.
Heat treatment per 100 bricks	2hrs.	5 hrs.

**Total costs of the two departments in one month were:**

Forming	₹ 21,200
Heat Treatment	₹48,800

**Production during the month was:**

Building Bricks	1,30,000 Nos.
Fire Bricks	70,000 Nos.

Prepare statement of manufacturing costs for the two varieties of bricks.

**Solution:****Statement Showing Number of Hours**

Particulars	Buil. Bricks	Fire Bricks	Total
Forming			
(1,30,000/100) x 3	3,900	1,400	5,300
(70,000/100) x 2			
Heat treatment	2,600	3,500	6,100
(1,30,000/100) x 2			
(70,000/100) x 5			
Total	6,500	4,900	11,400

Cost of forming per hour =  $21,200 / 5,300 = 4$

Cost of Heat treatment per hour =  $48,800 / 6,100 = 8$

**Statement showing computation of manufacturing cost per two varieties of bricks:** Amount (₹)

Particulars	Buil. Bricks	Fire Bricks	Total
Forming (3,900 x 4), (1,400 x 4)	15,600	5,600	21,200
Heat treatment (2,600 x 8), (3,500 x 8)	20,800	28,000	48,800
Total	36,400	33,600	70,000

**Illustration 23**

Deluxe limited undertook a contract for ₹5,00,000 on 1st July, 2016. On 30th June 2017 when the accounts were closed, the following details about the contract were gathered:

Particulars	Amount (₹)
Materials purchased	1,00,000
Wages paid	45,000
General expenses	10,000
Plant Purchased	50,000
Materials on hand 30-6-2017	25,000
Wages accrued 30-6-2017	5,000
Work certified	2,00,000
Cash received	1,50,000
Depreciation of Plant	5,000
Work uncertified	15,000

The above contract contained an escalator clause which read as follows:

“In the event of prices of materials and rates of wages increase by more than 5% the contract price would be increased accordingly by 25% of the rise in the cost of materials and wages beyond 5% in each case”.

It was found that since the date of signing the agreement the prices of materials and wage rates increased by 25% the value of the work certify does not take into account the effect of the above clause.

Prepare the contract account. Working should form part of the answer.

**Solution:**

$$\begin{aligned}\text{Cost of material \& wages incurred} &= ₹ (1,00,000 + 45,000 + 5,000 - 25,000) \\ &= ₹1,25,000\end{aligned}$$

$$\begin{aligned}\text{Cost of material \& wages before increase in prices} &= ₹ (1,25,000 \times 100/125) \\ &= ₹1,00,000\end{aligned}$$

$$\begin{aligned}\text{Increase in contract price} &= ₹25/100 [1,25,000 - ₹ (1,00,000 \times 105/100)] \\ &= ₹5,000 *\end{aligned}$$



Dr.		Contract Account		Cr.	
Particulars	Amount (₹)	Particulars	Amount (₹)	Particulars	Amount (₹)
To, Material purchased A/c	1,00,000	By, Material on hand			25,000
To, Wages A/c	50,000	Work certified	2,05,000		2,20,000
To, General Expenses A/c	10,000	Work uncertified	<u>15,000</u>		
To, Depreciation on plant	5,000				
To, P & L A/c	19,512				
To, Reserve c/d	60,488				
	<b>2,45,000</b>				<b>2,45,000</b>

#### 5.4 PROCESS COSTING – JOINT & BY-PRODUCTS

##### Process Costing

Process costing is that aspect of operation costing which is used to ascertain the cost of the product at each process or stage of manufacture. This method of accounting used in industries where the process of manufacture is divided into two or more processes. The objective is to find out the total cost of the process and the unit cost of the process for each and every process. Usually the industries where process costing used are textile, oil industries, cement, pharmaceutical etc.

##### Features of Process Costing

- Production is done having a continuous flow of products having a continuous flow of identical products except where plant and machinery is shut down for repairs etc.
- Clearly defined process cost centres and the accumulation of all costs by the cost centres.
- The maintenance of accurate records of units and part units produced and cost incurred by each process.
- The finished product of one process becomes the raw material of the next process or operation and so on until the final product is obtained.
- Avoidable and unavoidable losses usually arise at different stages of manufacture for various reasons.
- In order to obtain accurate average costs, it is necessary to measure the production at various stages of manufacture as all the input units may not be converted into finished goods.
- Different products with or without by-products are simultaneously produced at one or more stages or processes of manufacture. The valuation of by-products and apportionment of joint cost before joint of separation is an important aspect of this method of costing.
- Output is uniform and all units are exactly identical during one or more processes. So the cost per unit of production can be ascertained only by averaging the expenditure incurred during a particular period.

##### Applications of Process Costing

The industries in which process costs may be used are many. In fact a process costing system can usually be devised in all industries except where job, batch or unit or operation costing is necessary. In particular, the following are examples of industries where process costing is applied:

Chemical works	Textile, weaving, spinning etc.
Soap making	Food products
Box making	Canning factory
Distillation process	Coke works
Paper mills	Paint, ink and varnishing etc.
Biscuit works	Meat products factory
Oil refining	Milk dairy

**Difference between Job Costing and Process Costing:**

	<b>Job Costing</b>	<b>Process Costing</b>
(i)	The form of specific order costing which applies where the work is undertaken to customer's special requirements.	That form of costing which applies where standardised goods are produced and production is in continuous flow, the products being homogeneous.
(ii)	The job is the cost unit and costs are collected for each job.	Costs are collected by process or department on time basis and divided by output for a period to get an average cost per unit.
(iii)	Losses are generally not segregated.	Normal losses are carefully predetermined and abnormal losses are segregated.
(iv)	Overheads are allocated and apportioned to cost centres then absorbed by jobs, in proportion to the time taken.	Units pass through the same processes. Overheads are apportioned to processes on some suitable basis, some times, pre-determined rates may be used
(v)	Joint products / By-products do not usually arise in jobbing work.	Joint products/By-products do arise and joint cost apportionment is necessary.
(vi)	Standard costing is generally not suitable for jobbing work.	The standardised nature of products and processing methods lends itself to the adoption of standard costing.
(vii)	Work-in-progress valuation is specific and is obtained from analysis of outstanding jobs.	For WIP valuation operating costs have to be spread over fully complete output and partially complete products using the concept of equivalent units.
(viii)	Each job is separate and independent of others. Costs are computed when a job is complete.	Products lose their individual identity as they are manufactured in a continuous flow. Costs are calculated at the end of cost period.
(ix)	There are usually no transfers from one job to another unless there is a surplus work or excess production.	Transfer of costs from one process to another is made, as the product moves from one process to another.
(x)	There may or may not be work-in-progress at the beginning or end of the accounting period.	There is always some work-in-process at the beginning as well as at the end of the accounting period.
(xi)	Proper control is comparatively difficult as each product unit is different and the production is not continuous.	Proper control is comparatively easier, as the production is standardised and is more stable.
(xii)	It requires more forms and details.	It requires few forms and less details.

**Normal Process Loss**

It is the loss which is unavoidable on account of inherent nature of production process. Such loss can be estimated in advance on the basis of past experience or available data. The normal process loss is recorded only in terms of quantity and the cost per unit of usable production is increased accordingly. Where scrap possesses some value as a waste product or as raw material for an earlier process, the value thereof is credited to the process account. This reduces the cost of normal output; process loss is shared by usable units.

**Abnormal Process Loss**

Any loss caused by unexpected or abnormal conditions such as plants breakdown, sub-standard materials, carelessness, accident etc., or loss in excess of the margin anticipated for normal process loss should be regarded as abnormal process loss. The units of abnormal loss or gain are calculated as under:



Abnormal loss (or gain) = Total Loss – Normal Loss

The valuation of abnormal loss should be done with the help of this formula:

$$\text{Value of Abnormal Loss} = \frac{(\text{Normal Cost of Normal Output})}{(\text{Normal Output})} \times \text{Units of Abnormal Loss}$$

### Abnormal Gain

We know that margin allowed for normal loss is an estimate, (i.e., on the basis of expectation in process industries in normal conditions) and slight differences are bound to occur between the actual output of a process and that anticipated. These differences will not always represent increased loss, on occasions the actual loss will be less than that expected. Thus, when actual loss in a process is smaller than that was expected, an abnormal gain results. The value of the gain will be calculated in similar manner to an abnormal loss.

The Abnormal Gain Account is to be debited for the loss of income on account of less quantity of sale of scrap available as a result of abnormal gain and Normal Process Loss Account credited accordingly. The balance is transferred to Costing Profit and Loss Account as abnormal gain.

### Equivalent Production

This represents the production of a process in terms of completed units. In other words it means converting the incomplete production units into its equivalent of complete units. In each process an estimate is made of the percentage completion of any work-in-progress. A production schedule and a cost schedule will then be prepared. The work-in-progress is inspected and an estimate is made of the degree of completion, usually on a percentage basis. It is most important that this estimate is as accurate as possible because a mistake at this stage would affect the stock valuation used in the preparation of final accounts. The formula for equivalent production is:

Equivalent units of work-in-progress

$$= \text{Actual no. of units in process of manufacture} \times \text{Percentage of work completed}$$

For example, if 20% work has been done on the average of 1,000 units still in process, then 1,000 such units will be equal to 200 completed units. The cost of work-in-progress will be equal to 200 completed units.

### Calculation of Equivalent Production

The following steps are worth noting in its calculation:

- State the opening work-in-progress in equivalent completed units by applying the percentage of work needed to complete the unfinished work of the previous period. If the opening work-in-progress is 100 units which is 40 percent completed, then the equivalent units of this will be  $100 \times 60\%$  i.e. 60 units.
- Add to (a), the number of units started and completed during the period. This can be found out by deducting the units in the closing work-in-progress from the number of units put into the process.
- Add to the above, the equivalent completed units of closing work-in-progress. This can be found out by applying the percentage of work done on the finished units at the end of the period.

There are mainly three methods of calculating cost per unit, out of which FIFO method and Weighted Average Method is used in equivalent production.

### First In First Out Method [FIFO]

In this method, the assumption is that the incomplete units from the opening stock are completed first and then the units introduced in the process are completed. The costs added in each process during the current period is prorated to the production necessary to complete the opening work in progress, to



complete the units added in the process and units in the work in progress. The objective of the first in first out method is to value the inventory at the current costs and as such the main problem is to calculate the equivalent production under this method.

### Average Method

Process costs are sometimes computed on the basis of average costs. Where degree of completion of opening work in progress is not given, average method is used. The average process cost is obtained by adding the cost of opening work in progress and the cost of units introduced in the process during the current period and dividing this total cost by total equivalent units obtained by adding the number of units completed and equivalent units of the closing work in progress of each element, material, labor and overheads. The main object of average method is to even out the fluctuations in prices and hence is used when the prices fluctuate widely during a particular period.

### Weighted Average Method

If a manufacturing unit is manufacturing two or more products, which are quite dissimilar to each other, weighted average method is used. Under this method, weighted average is computed and used in valuation of the incomplete units.

### Illustration 24

The following particulars for process II are given:

Particulars	UNITS	Amount (₹)
Transfer to process II at cost	4,000	9,000
Direct wages		2,000
Direct material		3,000
Transfer to Finished stock	3,240	

Factory overheads in process are absorbed at a rate of 400% of direct material. Allowance for Normal loss is 20% of Units worked. Scrap value is ₹ 5 per unit.

Evaluate the cost of transfer to finished stock. Using the information supplied above, show the amount of gain or loss in the process to be taken to Cost Profit and Loss A/c.

### Solution:

Dr.		PROCESS-II- Account		Cr.	
Particulars	Units	Amount (₹)	Particulars	Units	Amount (₹)
To, Transfer from Process - I	4000	9,000	By Normal Loss A/c	800	4000
To, Direct Wages A/c		2,000	(4000 x 20%) x 5		
To, Direct Material A/c		3,000	By Transfer to Finished Stock A/c	3,240	22,275
To, Factory Overheads 3000x 400%		12,000	@ 6.875 per unit		
To, Abnormal Gain A/c $\frac{(26000 - 4000)}{(4000 - 800)} \times 40 = 6.875$	40	275			
	<b>4,040</b>	<b>26,275</b>		<b>4,040</b>	<b>26,275</b>

Dr.			Abnormal Gain Account			Cr.		
Particulars	Units	Amount (₹)	Particulars	Units	Amount (₹)			
To, Process - II A/c	40	200	By, Process II A/c	40	275			
To, Costing Profit & Loss A/c	-	75						
	40	275		40	275			

**Illustration 25**

Product-X is obtained after it passes through three distinct processes. You are required to prepare process account from the following information:

	PROCESSES			
	TOTAL	I	II	III
Material	15,084	5,200	3,960	5,924
Direct wages	18,000	4,000	6,000	8,000
Production overheads	18,000	-	-	-

1,000 units @ ₹ 6 per unit was introduced in Process I production overhead to be distributed at 100% on direct wages.

ACTUAL OUTPUT	UNITS	NORMAL LOSS	VALUE OF SCRAP (₹ per unit)
Process-I	950	5%	4
Process-II	840	10%	8
Process-III	750	15%	10

Prepare Process Accounts for I, II & III

**Solution:**

Dr.			PROCESS-I- Account			Cr.		
Particulars	Units	Amount (₹)	Particulars	Units	Amount (₹)			
To, Material introduced 1000 @ ₹ 6/-	1000	6,000	By, Normal Loss (5% of 950)×4	50	200			
To, Additional Material A/c		5,200	By, Transfer to Process-II A/c @ ₹20/- per unit	950	19,000			
To, Direct Labour A/c		4,000						
To, Production Overheads A/c		4,000						
	<b>1000</b>	<b>19,200</b>		<b>1000</b>	<b>19,200</b>			

Dr.			PROCESS-II- Account			Cr.		
Particulars	Units	Amount (₹)	Particulars	Units	Amount (₹)			
To, Transfer from Process-I A/c	950	19,000	By, Normal Loss (10% of 840)×8	95	760			
To, Direct Material		3,960	By, Abnormal Loss	15	600			
To, Direct Labour		6,000						
To, Production Overheads		6,000	$\frac{34960-760}{950-95} \times 15$					
			By, Transfer to Process-III A/c @ ₹40/-	840	33,600			
	<b>950</b>	<b>34,960</b>		<b>950</b>	<b>34,960</b>			



Dr. PROCESS-III- Account Cr.

Particulars	Units	Amount (₹)	Particulars	Units	Amount (₹)
To, Transfer from Process –II A/c	840	33,600	By, Normal Loss (15% of 840)×10	126	1,260
To, Direct Material A/c		5,924	By, Transfer to Finished Stock	750	57,000
To, Direct Labour A/c		8,000	A/c @ ₹76 per unit		
To, Production Overheads A/c		8,000			
To, Abnormal Gain A/c	36	2,736			
$\frac{55524-1260}{840-126} \times 36$					
	876	58,260		876	58,260

**Illustration 26**

A product passes through three processes— A, B and C. 10,000 units at a cost of ₹1.10 were issued to Process A. The other direct expenses were as follows:

	PROCESS-A	PROCESS-B	PROCESS-C
Sundry materials	1,500	1,500	1,500
Direct labour	4,500	8,000	6,500
Direct expenses	1,000	1,000	1,503

The wastage of process 'A' was 5% and in process 'B' 4%

The wastage of process 'A' was sold at ₹0.25 per unit and that of 'B' at ₹ 0.50 per unit and that of C at ₹ 1.00.

The overhead charges were 160% of direct labour. The final product was sold at ₹10 per unit fetching a profit of 20% on sales. Find out the percentage of wastage in Process 'C'

**Solution:**

Dr. PROCESS-A- Account Cr.

Particulars	Units	Amount (₹)	Particulars	Units	Amount (₹)
To, Material introduced A/c	10000	11,000	By Normal Loss A/c (10000 x 5%) x 0.25	500	125
To, Additional Material A/c		1,500	By Transfer to Process-B A/c @ ₹2.64 per unit	9500	25075
To, Direct Labour A/c		4,500			
To, Direct Expenses A/c		1,000			
To, Overheads A/c		7,200			
	10000	25,200		10000	25,200

Dr. PROCESS-B- Account Cr.

Particulars	Units	Amount (₹)	Particulars	Units	Amount (₹)
To, Transfer from Process–A A/c	9500	25,075	By, Normal Loss A/c (9,500 x 4%) x 0.5	380	190
To, Direct Material A/c		1,500	By, Transfer to Process-C A/c @ ₹ 5.283	9120	48,185
To, Direct Labour A/c		8,000			
To, Direct Expenses A/c		1,000			
To, Overheads A/c		12,800			
	9,500	48,375		9,500	48,375

Dr.

## PROCESS-C- Account

Cr.

Particulars	Units	Amount (₹)	Particulars	Units	Amount (₹)
To, Transfer from Process-B A/c	9120	48,185	By, Normal Loss A/c (Ref. Working Notes)	696	696
To, Direct Material A/c		1,500	By, Transfer to Finished Stock A/c @ ₹8/- per unit	8424	67,392
To, Direct Labour A/c		6,500			
To, Direct Expenses A/c		1,503			
To, Overheads A/c		10,400			
	9120	68,088		9120	68,088

**Working Notes:**

(a) Sale Price per unit	10
(-) Profit @ 20%	<u>2</u>
Cost per unit	<u>8</u>

(b) Let the No. of units of loss in Process 'C' be 'x'

$$\text{Scrap value} = X \times 1 = ₹ X$$

$$68,088 - x = 8(9,120 - x) \text{ units}$$

$$68,088 = 72,960 - 7x$$

$$7x = 4,872$$

$$X = 696 \text{ units}$$

$$\begin{aligned} \text{Percentage of Normal wastage} &= \frac{696}{9120} \times 100 \\ &= 7.63\% \end{aligned}$$

**Illustration 27**

	Degree of completion			
	Units	Units		
Opening stock	1,600	Units	Material	70%
			Labour	60%
			Overhead	60%
Transfer from Process I	10,200	Units		
Transfer to next process	9,200	Units		
Units scrapped	800	Units		
Normal loss 10% of Input				
Closing stock	1,800	Units	Material	60%
			Labour	40%
			Overhead	40%

Prepare a Statement of Equivalent Production.

**Solution:****Statement of Equivalent Production**

Input	Output	Units	Material		Labour		Overheads	
			%	Units	%	Units	%	Units
1600	Opening Stock	1600	30	480	40	640	40	640
10200	Normal Loss	1000	-	-	-	-	-	-
	Finished Units	7600	100	7600	100	7600	100	7600
	Closing Stock	1800	60	1080	40	720	40	720
		12000		9160		8960		8960
	Less: Abnormal Gain	200	100	200	100	200	100	200
<b>11800</b>		<b>11800</b>		<b>8960</b>		<b>8760</b>		<b>8760</b>

**Illustration 28**

From the following information compute (i) Equivalent production (ii) statement of apportionment of cost, (iii) prepare Process Account.

Work-in-progress (opening) 200 units @ ₹4 per unit	Stage of completion 100% Material 40% Labour & Overheads
Units introduced 1050	
Transfer to next process 1100 units	
Closing stock 150 units	100% Material 70% Labour and Overhead

Other information:	Amount (₹)
Material cost	1,050
Labour	2,250
Production Overhead	1,125
	4,425

**Solution:****Statement of Equivalent Production**

Input	Output	Units	Material		Labour		Overheads	
			%	Units	%	Units	%	Units
200	Opening Stock	200	-	-	60	120	60	120
1,050	Finished Stock (1100-200) during this period	900	100	900	100	900	100	900
	Closing Stock	150	100	150	70	105	70	105
1250		1,250		1,050		1,125		1,125





**Statement of Cost per unit**

Amount (₹)

Particulars	Amount (₹)	Equivalent units	Cost per unit
Material	1,050	1,050	1
Labour	2,250	1,125	2
Production Overhead	1,125	1,125	1

**Value of Closing Stock**

Amount (₹)

Element	Units	Cost per unit	Total Cost
Material	150	1	150
Labour	105	2	210
Overhead	105	1	105
			465

Dr.

**Process Account**

Cr.

Particulars	Units	Amount (₹)	Particulars	Units	Amount (₹)
To, Opening Stock A/c	200	800	By, Closing Stock	150	465
To, Material A/c	1050	1,050	By, Transfer to Finished Stock A/c @ ₹ 4.327 per unit	1100	4,760
To, Labour A/c		2,250			
To, Overheads A/c		1,125			
	1,250	5,225		1,250	5,225

**Working Note for checking transfer value to the finished stock:**

Amount (₹)

Element	Units	Cost per unit	Total Cost
Material	-	-	800
Labour	120	2	240
Overhead	120	1	120
			1,160
900 x 4			3,600
			4,760

**Illustration 29**

From the following information prepare process account.

OPENING STOCK		DEGREE OF COMPLETION
800 Units @ ₹6 per unit	₹ 4,800	Material I - 100% Material II - 60% Labour & Overheads 40%
Transfer from Process NO - I 12,000 units costing	₹16,350	
Transfer to next process	9,700 units	
Normal process loss	10%	
Closing stock	1,800 units	

**Degree of Completion:** For units scrapped:- Material 100% Labour and Overheads 50%.

For closing stock: Material 60%; Labour and overheads 50%

Scrap realized Re.1.00 per unit

Other information: Material ₹10,500; Labour ₹20,760; Overheads ₹16,670



**Solution:**

**Statement of Equivalent Production**

Input	Output	Units	Material-I		Material - II		Labour		Overheads	
			%	Units	%	Units	%	Units	%	Units
800	Opening Stock	800	-	-	40	320	60	480	60	480
12000	Normal Loss (800+12000-1800) x 10%	1100	-	-	-	-	-	-	-	-
	Finished Units (9700-800)	8900	100	8900	100	8900	100	8900	100	8900
	Closing Stock	1800	100	1800	60	1080	50	900	50	900
		12600		10700		10300		10280		10280
	Add: Abnormal Loss	200		200	100	200	50	100	50	100
<b>12800</b>		<b>12800</b>		<b>10900</b>		<b>10500</b>		<b>10380</b>		<b>10380</b>

**Statement of Cost per unit** Amount (₹)

Particulars	Cost	Equivalent Cost	Cost per unit
Material-I	16350	10900	1.5
Material-II	10500	10500	1.0
Labour	20760	10380	2.0
Overhead (16,670-1,100)	15570	10380	1.5

**Value of Abnormal Loss** Amount (₹)

Element	Units	Cost per unit	Total Cost
Material-I	200	1.5	300
Material-II	200	1.0	200
Labour	100	2.0	200
Overhead	100	1.5	150
			<b>850</b>

**Value of Closing Stock** Amount (₹)

Element	Units	Cost per unit	Total Cost
Material-I	1800	1.5	2,700
Material-II	1080	1.0	1,080
Labour	900	2.0	1,800
Overhead	900	1.5	1,350
			<b>6,930</b>

**Dr.** **Process Account** **Cr.**

Particulars	Units	Amount (₹)	Particulars	Units	Amount (₹)
To, Opening Stock A/c	800	4,800	By, Normal Loss A/c	1100	1,100
To, Transfer from Process-I A/c	12000	16,350	By, Closing Stock A/c	1800	6,930
To, Material A/c		10,500	By, Abnormal Loss A/c	200	850
To, Labour A/c		20,760	By, Transfer to Next Process A/c	9700	60,200
To, Overheads A/c		16,670	@ ₹ 6.206 per unit		
	12800	69,080		12800	69,080

**Illustration 30**

SM Ltd., furnished you the following information relating to process B for the month of October, 2017.

- (i) Opening work-in-progress- NIL
- (ii) Units introduced - 10,000 units @ ₹3 per unit
- (iii) Expenses debited to the process; Direct materials ₹14,650; Labour ₹21,148; Overheads ₹ 42,000
- (iv) Finished output - 9,500 units
- (v) Closing work-in-progress 350 units; Degree of completion : Material 100%; Labour and overheads 50%
- (vi) Normal loss in process- one percent of input
- (vii) Degree of completion of abnormal loss: Material 100% ; Labour and Overheads 80%
- (viii) Units scrapped as normal loss were sold at ₹1 per unit
- (ix) All the units of abnormal loss were sold at ₹2.50 per unit.

Prepare:

- (a) Statement of Equivalent Production
- (b) Statement of Cost
- (c) Process - B Account
- (d) Abnormal Loss Account

**Solution:**

**Statement of Equivalent Production**

Input	Output	Units	Material		Labour		Overheads	
			%	Units	%	Units	%	Units
10000	Normal Loss	100	-	-	-	-	-	-
	Finished Units	9500	100	9500	100	9500	100	9500
	Closing Stock	350	100	350	50	175	50	175
	Abnormal Loss	50	100	50	80	40	80	40
10000		10000		9900		9715		9715

**Statement of Cost**

Amount (₹)

Particulars	Cost	Equivalent units	Cost per unit
Material (30000+14650)-100	44,550	9,900	4.5000
Labour	21,148	9,715	2.1768
Overhead	42,000	9,715	4.3232

**Value of Closing Stock**

Element	Units	Cost per unit	Total Cost
Material	350	4.5	1575.00
Labour	175	2.1768	380.94
Overhead	175	4.3232	756.56
			2712.50

Say, ₹ 2713

**Value of Abnormal Loss**

Element	Units	Cost per unit	Total Cost
Material	50	4.5	225.000
Labour	40	2.1768	87.072
Overhead	40	4.3232	172.928
			485

**Dr. Process Account Cr.**

Particulars	Units	Amount (₹)	Particulars	Units	Amount (₹)
To, Material Introduced	10000	30000	By, Normal Loss A/c	100	100
To, Material A/c		14650	By, Abnormal Loss A/c	50	485
To, Labour A/c		21148	By, Closing Stock A/c	350	2,713
To, Overheads A/c		42000	By, Transfer to Next Process @ ₹ 11 per unit	9500	1,04,500
	10000	107798		10000	1,07,798

**Dr. Abnormal Loss Account Cr.**

Particulars	Units	Amount (₹)	Particulars	Units	Amount (₹)
To, Process A/c	50	485	By, Debtors / Cash	50	125
			By, Costing P & L A/c	-	360
	50	485		50	485

**Illustration 31**

AB Ltd. is engaged in process Engineering Industry. During the month of April, 2015, 2,000 units were introduced in Process 'X'. The normal loss was estimated at 5% of input. At the end of the month 1,400 units had been produced and transferred to process Y. 460 units incomplete and 140 units after passing through fully the entire process had to be scrapped. The incomplete units had reached the following stage of completion.

Material	75% completed
Labour	50% completed
Overhead	50% completed

Following are the further information on the Process 'X'

	Amount (₹)
Cost of the 2,000 units	58,000
Additional Direct Material	14,400
Direct Labour	33,400
Direct Overheads	16,700

Units scrapped released ₹ 10 each. Prepare Statement of Equivalent Production, Statement of Cost, Statement of Evaluation and the Process X Account.

**Solution:****Statement of Equivalent Production**

Input	Output	Units	Material		Labour		Overheads	
			%	Units	%	Units	%	Units
2000	Normal Loss	100	-	-	-	-	-	-
	Closing Stock	460	75	345	50	230	50	230
	Finished Units	1,400	100	1,400	100	1,400	100	1,400
	Abnormal Loss	40	100	40	100	40	100	40
<b>2000</b>		2,000		1,785		1,670		1,670

**Statement of Cost**

Amount (₹)

Particulars	Cost	Equivalent Units	Cost per unit
Material (58000+14400)-1000	71,400	1,785	40
Direct Labour	33,400	1,670	20
Overhead	16,700	1,670	10

**Value of Closing Stock**

Amount (₹)

Element	Units	Cost per unit	Total Cost
Material	345	40	13800
Labour	230	20	4600
Overhead	230	10	2300
			20700

**Value of Abnormal Loss**

Amount (₹)

Element	Units	Cost per unit	Total Cost
Material	40	40	1600
Labour	40	20	800
Overhead	40	10	400
			2800



Dr.		Process - 'X' Account		Cr.	
Particulars	Units	Amount (₹)	Particulars	Units	Amount (₹)
To, Material introduced	2000	58,000	By, Normal Loss	100	1,000
To, Additional Material		14,400	By, Abnormal Loss	40	2,800
To, Labour		33,400	By, Closing Stock	460	20,700
To, Overheads		16,700	By, Transfer to Next Process @ ₹ 70 per unit.	1400	98,000
	2000	1,22,500		2000	1,22,500

**Illustration 32**

The product of a manufacturing unit passes through two distinct processes. From the past experience the incidence of wastage is ascertained as under:

PROCESS 'A' 2%

PROCESS 'B' 10%

In each case the percentage of wastage is computed on the number of units entering the process concerned. The sales realisation of wastage in Process A and B are ₹ 25 per 100 units and ₹50 per 100 units respectively.

The following information is obtained for the month of April, 2015; 40,000 units of crude material were introduced in Process A at a cost of ₹ 16,000.

Particulars	PROCESS A	PROCESS B
	Amount (₹)	Amount (₹)
Other Materials	16,000	5,000
Direct Labour	9,000	8,000
Direct Expenses	8,200	1,500
	Units	Units
Output	39,000	36,500
Finished Product Stock:		
April 1	6,000	5,000
April 30	5,000	8,000
Value of stock per unit on April 1st	1.20	1.60

Stocks are valued and transferred to subsequent process at weighted average costs. Prepare respective Process Accounts and Stock Accounts.

**Solution:**

Dr.		Process A- Account		Cr.	
Particular	Units	Amount (₹)	Particular	Units	Amount (₹)
To, Material Introduced	40000	16,000	By, Normal Loss A/c (40,000 x 2%) x 25/100	800	200
To, Additional Materials		16,000	By, Abnormal Loss A/c $\frac{49,200-200}{40,000-800} \times 200$	200	250
To, Direct Labour A/c		9,000	By, Transfer to Process-A Finished Stock A/c	39,000	48,750
To, Direct Expenses A/c		8,200			
	40,000	49,200		40,000	49,200



Dr. Process – A Finished Stock Account			Cr.		
Particular	Units	Amount (₹)	Particular	Units	Amount (₹)
To, Opening Stock A/c	6,000	7,200	By, Closing Stock A/c	5,000	6,217
To, Transfer from Process –A-A/c	39,000	48,750	<u>55,950</u> 45,000 × 5000		
			By, Transfer to Process B A/c @ ₹ 1.243 per unit	40,000	49,733
	45,000	55,950		45,000	55,950

Dr. Process-B- Account			Cr.		
Particulars	Units	Amount (₹)	Particulars	Units	Amount (₹)
To, Transfer from process – A Finished Stock A/c	40000	49,733	By, Normal Loss A/c (40000x 10%) x 50/100	4000	2,000
To, Other Materials		5,000	By, Transfer to Process-B Finished Stock A/c	36500	63,097
To, Direct Labour A/c		8,000			
To, Direct Expenses A/c		1,500			
To, Abnormal Gain A/c	500	864			
<u>64,233–2,000</u> 40,000–4,000 × 500					
	40,500	65,097		40,500	65,097

Dr. Process – B Finished Stock Account			Cr.		
Particulars	Units	Amount (₹)	Particulars	Units	Amount (₹)
To, Opening Stock A/c	5000	8,000	By, Closing Stock A/c	8000	13,705
To, Transfer from Process –B A/c	36500	63,097	<u>71,097</u> 41,500 × 8,000		
			By, Transfer to Next Process A/c @ ₹ 1.7132 per unit	33500	57,392
	41500	71,097		41500	71,097

**Illustration: 33**

The following information is obtained in respect of process 3 of the month of August:

Opening Stock	1,000 units
Value	Direct Material (I) ₹ 390; Direct material (II) ₹ 75; Direct Labour - ₹ 112; Production overhead - ₹ 118.
Process 2 transfer	6,000 units at ₹ 2,360
Process 4 transfer	4,700 units.
Direct material added in process	₹ 520
Direct labour employed	₹ 1,036
Production Over Heads	₹ 1,541
Units scrapped	300
Degree of completion	Direct material 100% Direct labour 80% Production overhead 60%
Closing stock	2,000 units
Degree of completion:	Direct material 60% Direct labour 50% Production overhead 40%



Normal loss: 5% of production units scrap realised 0.20 each.

Prepare Process Account on weighted Average method.

**Solution:**

**Statement of Equivalent Production**

Input	Particulars	Output Units		Material-II		Labour		Overheads	
			Units	%	Units	%	Units	%	Units
1000	Opening stock	--	--		--		--		--
6000	Normal loss	250	--		--		--		--
	Finished units	4700	4700	100	4700	100	4700	100	4700
	Closing stock	2000	2000	60	1200	50	1000	40	800
	Abnormal Loss *	50	50	100	50	80	40	60	30
7000		7000	6750		5950		5740		5530

**Statement of Cost**

		Material-I	Material-II	Labour	Overheads
Opening stock	390		75	112	118
Add: during the period	2360		520	1036	1541
	2750				
Less: Scrap value of					
Normal Loss (250 x 0.2)	<b>50</b>	<b>2700</b>	<b>595</b>	<b>1148</b>	<b>1659</b>
Cost per unit (₹)		0.40	0.10	0.20	0.30

Calculation of closing stock:

	Amount (₹)
Material I	2000 x 0.40 = 800
Material II	1200 x 0.10 = 120
Labour	1000 x 0.20 = 200
Overheads	800 x 0.30 = 240
	= 1360

**Value of abnormal loss:**

	Amount (₹)
Material I	50 x 0.40 = 20
Material II	50 x 0.10 = 5
Labour	40 x 0.20 = 8
Overheads	30 x 0.30 = 9
	= 42



Dr.		Process – 3 Account		Cr.	
Particulars	Units	Amount (₹)	Particulars	Units	Amount (₹)
To, Opening Stock A/c	1000	695	By, Normal loss A/c	250	50
To, Transfer from Process 2 A/c	6000	2,360	By, Abnormal loss A/c	50	42
To, Material A/c		520	By, Closing stock A/c	2000	1,360
To, Labour A/c		1,036	By, Transfer to process 4 A/c	4700	4,700
To, Overheads A/c		1,541	@ ₹ 1 per unit		
	7000	6,152		7000	6,152

### Joint and By-Products

#### Meaning of Joint Products

In several industries more than one product emerge from the manufacturing process. These products are sometimes produced intentionally while in some cases they emerge out of the main manufacturing process. Such products are termed as either joint products or by-products. Though sometimes these terms are used interchangeably, there is a major difference between the two and therefore it is necessary to understand clearly the difference between them. Similarly there is a difference between the accounting of the two and hence it is essential to define clearly the concepts of joint products and by-products.

In CIMA Terminology defines joint products as "two or more products separated in the course of processing each having a sufficiently high value to merit recognition as a main product". Joint products imply that they are produced from the same basic raw material, are comparatively of equal importance, are produced simultaneously by a common process and may require further processing after the point of separation.

#### Difference Between Joint products and Co-products

Joint products are frequently confused with co-products. However, there is significant difference between the two, the former being indivisible and the latter divisible. Common costs are allocable among products or services performed because each of the products or services could have been obtained separately. Therefore, any shared cost of obtaining them can be meaningfully allocated on the basis of relative usage of the common facilities. For example, the cost of fuel or power may be allocated to products based on production volumes and metered usage. Co-products do not always arise from the same operation or raw materials and the quantity of co-products is within the control of manufacturer. Thus different quantities of car, jeep and trucks can be produced in car manufacturing industry according to the need of the concern.

#### Features of Joint Products

- Joint products are the result of utilization of the same raw material and same processing operations. The processing of a particular raw material may result into the output of two or more products.
- All the products emerging from the manufacturing process are of the same economic importance. In other words, the sales value of those products may be more or less same and none of them can be termed as the major product.
- The products are produced intentionally which implies that the management of the concerned organization has intention to produce all the products.
- Some of joint products may require further processing or may be sold directly after the split off point.
- The manufacturing process and raw material requirement is common up to a certain stage of manufacturing. After the stage is crossed, further processing becomes different for each product. This stage is known as 'split off' point. The expenditure incurred up to the split off point is called as



joint cost and the apportionment of the same to different products is the main objective of the joint product accounting.

- (f) The management has little or no control over the relative quantities of the various products that will result.
- (g) Joint products are commonly produced in industries like, chemicals, oil refining, mining, meatpacking, automobile etc. In oil refining, fuel, oil, petrol, diesel, kerosene, lubricating oil are few examples of the joint products.

### Accounting for Joint Product Cost

Before we proceed to discuss the methods of accounting in case of joint products and by-products, it will be necessary to understand certain terms clearly. These terms are explained below:

- (i) **Split Off Point:** This is a point up to which, input factors are commonly used for production of multiple products, which can be either joint products or by-products. After this point, the joint products or byproducts gain individual identity. In other words, up to a certain stage, the manufacturing process is the same for all the products and a stage comes after which, the individual processing becomes different and distinct. For example, in a dairy, several products like, milk, ghee, butter, milk powder, ice-cream etc. may be produced. The common material is milk. The pasteurization of milk is a common process for all the products and after this process; each product has to be processed separately. This point is of special significance in the accounting of joint product and by-products because the joint cost incurred before this point is to be apportioned appropriately in the joint products.
- (ii) **Joint Costs:** Joint cost is the pre separation cost of commonly used input factors for the production of multiple products. In other words, all costs incurred before or up to the split off point are termed as joint costs or pre separation costs and the apportionment of these costs is the main objective of joint product accounting. Costs incurred after the split off point are post separation costs and can be easily identified with the products.

### Accounting Treatment

In case of joint products, the main objective of accounting of the cost is to apportion the joint costs incurred up to the split off point. As discussed earlier, the manufacturing process is same up to a certain stage and after crossing that stage; each product has distinct manufacturing process. Therefore the main problem is apportionment of the joint cost or the cost incurred up to the split off point. The total cost of production of the joint product will be cost incurred up to the split off point duly apportioned plus the cost incurred after the split off point. There is no problem of charging the cost incurred after the split off point as the cost can be identified easily. The main problem therefore is that of apportionment of the joint cost and the following methods are used for apportioning the same.

- (i) **Physical Quantity Method:** Under this method, cost apportionment is made in proportion to the volume of production. These physical measures may be units, pounds, liters, kilos, tones, gallons etc.
- (ii) **Average Unit Cost Method:** Under this method, the joint cost is apportioned to the joint products by computing the average unit cost of the product units. The average unit cost is computed by dividing the total manufacturing cost by the total number of units produced of all products. This method is useful where all the products produced are uniform with each other in all the respects. This method will not be useful if the production units are not similar with each other.
- (iii) **Weighted Average Method:** Under this method, weights are assigned to each unit based upon size of the units, difference in type of labor employed, material consumption, market share, efforts of labour required and so on. The joint cost is apportioned on the basis of the weights assigned to each product. This method is highly useful if the weights assigned are on objective basis. If subjective element creeps in, the method may not give accurate results.

**(iv) Selling Price Method:** Under this method, the joint cost is apportioned on the basis of sales value at the split off point. The logic is that a product should bear the share of the joint cost according to its sale price. If sales price is higher than that of the other products, more share of joint cost should be charged to that product and if it is comparatively less than that of other products, less share of joint cost should be charged to the same. Though logically this method seems to be sound, in practice, charging higher share of joint cost to the product with higher sales value may not be justified due to the fact that lesser efforts are required for manufacturing of the same.

### Meaning of By-Products

The term 'by-products' is sometimes used synonymously with the term 'minor products'. The by-product is a secondary product, which incidentally results from the manufacture of a main product. By-products are also produced from the same raw material and same process operations but they are secondary results of operation. The main difference between the joint product and byproduct is that there is no intention to produce the by-product while the joint products are produced intentionally. The relationship between the by-product and the main product changes with changes in economic or industrial conditions or with advancement of science. The by-product of an industry may become a main product and main product may become a by-product subsequently.

For example, (a) in sugar industry, sugar is a main product and molasses is a by-product (b) in coke ovens, gas and tar are incidentally produced in addition to the main product coke. Gas and tar are, therefore, treated as by-products. These minor secondary products have saleable or usable value and are incidentally produced in addition to the main product.

In CIMA Terminology, By-product is "a product which is recovered incidentally from the material used in the manufacture of recognized main products such as having either a net realizable value or a usable value which is relatively low in comparison with the saleable value of the main products. By products may further be processed to increase their realizable value".

Thus the term 'by-product' is generally used by businessmen and accountants to denote one or more products of relatively small value that are produced simultaneously with a product of greater value.

### Classification of By-Products

By-products can be classified into two groups according to marketable conditions at the split off point:

- (a) Those sold in the same form as originally produced, and
- (b) Those which may undergo further processing before sale.

### Accounting treatment

By-products are jointly produced products of minor importance and do not have separate costs until the split off point. They are not produced intentionally but are emerging out of the manufacturing process of the main products. The following methods are used for accounting of by-products. The methods are broadly divided into Non-Cost Methods and Cost Methods.

**(A) Non-Cost Methods:** The following methods are included in this category.

- (i) **Other income or miscellaneous income method:** Under this method, sales value of by-products is credited to the Profit and Loss Account and no credit is given in the Cost Accounts. The credit to the Profit and Loss Account is treated as other income or miscellaneous income. No effort is made for ascertaining the cost of the product. No valuation of inventory is made and all costs and expenses are charged to the main product. This is the least scientific method and is used where the sales value of the by-product is negligible.
- (ii) **Total sales less total cost:** Under this method, sales value of by-product is added to the sales value of the main product. Further the total cost of the main product including the cost of the by-product is deducted from the sales revenue of the main product and by-product. All costs and expenses are charged to the main product.



- (iii) **Total cost less sales value of by-product:** In this method, the total cost of production is reduced by the sales value of the by-product. This method seems to be more acceptable because like waste and scrap, by-product revenue reduces the cost of major products.
- (iv) **Total cost less sales value of by-products after setting off selling and distribution overheads of by-products:** Sales value of the by-product minus the selling and distribution overheads of byproduct is deducted from the total cost. Selling and distribution overheads are charged against by-products actually sold.
- (v) **Reverse cost method:** This method is based on the view that the sales value of the by-product contains an element of profit. It is agreed that this element of profit should not be credited to the Profit and Loss Account. The cost of by-product is arrived at by working backwards. Selling price of the by-product is deflated by an assumed gross profit margin. Thus under this method, sales value of the by-product is first reduced by, an estimated profit margin, selling and distribution expenses and then the post split off costs and then the cost of the main product is thus reduced by this net figure.

**(B) Cost Methods:** The following methods are included in this category.

- (i) **Replacement or opportunity cost method:** If the by-products are consumed captively, they are valued at the opportunity cost method or replacement cost method. This means the cost which would have been incurred had the by-product been purchased from outside. For example, bagasse, which is one of the main by-product of sugar industry and which is used for the factory as a fuel in the boiler is valued at the market value, i.e. the price that would have been paid if it would have been purchased from outside.
- (ii) **Standard cost method:** Under this method, the by-product is valued at the standard cost determined for each product. The standard cost may be based on technical assessment. Standard cost of the by-product is credited to the process account of the main product. Accordingly, the cost control of main product can be exercised effectively.
- (iii) **Joint cost proration:** Where the by-product is of some significance, it is appropriate that the joint costs should be apportioned between the main products and by-products on a most suitable and acceptable method. Thus in this method, no distinction is made between the joint product and byproduct. Industries, where the by-products are quite important, use this method. For example, in a petroleum refinery, gas was earlier considered as a by-product. Now it has assumed the importance like petrol, diesel etc. and is being treated as joint product. Accordingly, the joint cost is prorated between the joint product and the by-product.

### **Difference between Main product & Joint and By-Products**

It is very difficult to make distinction between the joint products, main products and by-products. There are, however, two checks which may be applied to determine if a product is a by-product or a joint product or a main product:

- (i) **Value:** If one of the products is of considerably large value than the others it will usually be considered the main product. Conversely any product which is of considerably less value is likely to be classified as a by-product. If both or some or all the products are more or less of equal value, they are likely to be classified as joint products.
- (ii) **Manufacturing objective:** If the company's objective is to produce A, then B, C and D produced simultaneously will be classified as by-products. This is independent of the comparative values of the various products. If the objective is to produce A and B, they become joint products and C and D become by-products. For example, in coke oven, the objective being production of coke, this is considered as the main product, and gas and tar as by-products.



There are instances when a by-product attains so much importance in terms of sales value and/or the company objective, then it is regarded as a main product. There are also instances when a by-product is more important than the main product, so that they by-product becomes the main product and the main product becomes the by-product.

### Illustration 34

X, Y Ltd. manufactures product A which yields two by-products B and C. The actual joint expenses of manufacturing for a period were ₹ 8,200.

The profits on each product as a percentage of sales are 33-1/3%, 25% and 15% respectively. Subsequent expenses are as follows:

Particulars	Products			Amount (₹)
	'A'	'B'	'C'	
Material	100	75	25	
Direct	200	125	50	
Overheads	<u>150</u>	<u>125</u>	<u>75</u>	
	<b>450</b>	<b>325</b>	<b>150</b>	
Sales	6,000	4,000	2,500	

Apportion the joint expenses

### Solution:

#### Statement Showing Apportionment of Joint Expenses

Particulars	A	B	C	Total
Sales	6,000	4,000	2,500	12,500
(-) Profit	2,000	1,000	375	3,375
Total Cost (Joint & Separate cost)	4,000	3,000	2,125	9,125
Separate Expenses	450	325	150	925
Share of Joint Expenses	3,550	2,675	1,975	8,200

### Illustration 35

A chemical process yields 60% of the material introduced as main Product - A and by Product B 15% by - Product - C 20% and 5% being the wastage.

The ratio of absorption of Raw material and Labour in the process products is as follows :

- One unit of product C requires half the raw material required for one unit of product - B, one unit of product - A requires 1 ½ time the raw material required for product - B.
- Product A requires double the time needed for the production of one unit of B and one unit of C
- Product C requires half the time required for the production of one unit of product B
- Overheads are to be absorbed in the ratio of 6:1:1
- Cost Data: Input 1,000 units of cost ₹4,600
 

Direct labour	₹4,100
Overheads	₹6,000

Calculate cost of distribution between the above products.

**Solution:**

$$A = 1,000 \times 60\% = 600 \text{ units}$$

$$B = 1,000 \times 15\% = 150 \text{ units}$$

$$C = 1,000 \times 20\% = 200 \text{ units}$$

$$\text{Wasteage} = 1,000 \times 5\% = 50 \text{ units}$$

**Statement showing apportionment of Joint Cost**

Element	Basis of Apportionment	Total	Main Product A	By Product B	By Product C
Material	18:3:2	4,600	3,600	600	400
Labour	36:3:2	4,100	3,600	300	200
Overheads	6:1:1	6,000	4,500	750	750
		14,700	11,700	1,650	1,350

**Material:**

$$\begin{aligned} A : B : C &= 3 \times 600 : 2 \times 150 : 1 \times 200 \\ &= 1800 : 300 : 200 \\ &= 18 : 3 : 2 \end{aligned}$$

**Labour:**

$$\begin{aligned} A : B : C &= 6 \times 600 : 2 \times 150 : 1 \times 200 \\ &= 3600 : 300 : 200 \\ &= 36 : 3 : 2 \end{aligned}$$

**Illustration 36**

The following data have been extracted from the books of M/s. Southern Coke Co. Ltd.

**JOINT PRODUCTS****YIELD IN LB OF RECOVERED  
PRODUCTS PER TONNE OF COAL**

Coke	1,420
Coal tar	120
Benzol	22
Sulphate of Ammonia	26
Gas	<u>412</u>
	<u>2,000</u>

The price of coal is ₹80 per tonne. The direct labour and overhead costs to the point of split-off are ₹40 and ₹60 respectively per tonne of coal. Calculate the material, labour and total cost of each product on the basis of weight.

**Solution:****Statement Showing Calculation of Material, Labour and Total Cost of Each Product** **Amount (₹)**

Element	Total	(1420) Coke	(120) Coal tar	(22) Benzol	(26) Sulphate	(412) Gas
Material	80.00	56.80	4.80	0.88	1.04	16.48
Labour	40.00	28.40	2.40	0.44	0.52	8.24
Overheads	60.00	42.60	3.60	0.66	0.78	12.36
	180.00	127.80	10.80	1.98	2.34	37.08

**Illustration 37**

A factory engaged in the production of Chemical X and in the course of manufacture in a by-product-Y is produced which after a separate process has a commercial value. Following are the information for the month of March.

	JOINT EXPENSES	SEPARATE EXPENSES	
		X	Y
Materials (₹)	10,000	2,000	2,800
Labour (₹)	4,000	2,500	2,500
Overheads (₹)	2,500	1,400	1,000

The output for the month was 150 quintals of X and 50 quintals of Y. The selling price of product Y is ₹200 per quintal. The profit on product Y is  $33\frac{1}{3}\%$  on cost price. Prepare an Account to show the cost of X per quintal.

**Solution:****Joint Expenses Account**

Dr.		Cr.	
Particulars	Amount (₹)	Particulars	Amount (₹)
To, Material	10,000	By, Y A/c	1,200
To, Labour	4,000	By, X's A/c	15,300
To, Overheads	2,500		
	16,500		16,500

**X's Account**

Dr.		Cr.	
Particulars	Amount (₹)	Particulars	Amount (₹)
To, Material	2,000	By, Cost of production A/c	
To, Labour	2,500	@ 141.33 per quintal.	21,200
To, Overheads	1,400		
To, Joint expenses A/c *	15,300		
	21,200		21,200



## Y's Account

Dr.

Cr.

Particulars	Amount (₹)	Particulars	Amount (₹)
To, Material	2,800	By, Cost of production A/c. (150 x 50)	7,500
To, Labour	2,500		
To, Overheads	1,000		
To, Joint expenses A/c	1,200		
	7,500		7,500

## Illustration 38

In manufacturing the main product 'A' a company processes the resulting waste material into two by products B and C. Using reversal cost method of by products, prepare a comparative profit and loss statement of the three products from the following data:

(i) Total cost upto separation point was ₹ 68,000

Amount (₹)

	A	B	C
(ii) Sales (all production)	1,64,000	16,000	24,000
(iii) Estimated net profit % to sale value	—	20%	30%
(iv) Estimated Selling expenses as % of sales value	20%	20%	20%
(v) Costs after separation	—	4,800	7,200

## Solution:

Apportionment of Joint expenses for the products

Amount (₹)

Particulars	B	C
Sales	16,000	24,000
(-) Profit	3,200	7,200
Total Cost	12,800	16,800
(-) Selling expenses	3,200	4,800
Manufacturing cost	9,600	12,000
(-) Separate expenses	4,800	7,200
Joint Expenses	4,800	4,800

Joint expenses of A = 68,000 – (4,800 + 4,800) = 58,400.

## Profit and Loss Statement

Amount (₹)

	Particulars	A	B	C	Total
(i)	Joint cost	58,400	4,800	4,800	68,000
(ii)	Separate cost	--	4,800	7,200	12,000
(iii)	Manufacturing cost (I + II)	58,400	9,600	12,000	80,000
(iv)	Selling expenses	32,800	3,200	4,800	40,800
(v)	Total cost (III + IV)	91,200	12,800	16,800	1,20,800
(vi)	Profit *	72,800	3,200	7,200	83,200
(vii)	Sales	1,64,000	16,000	24,000	2,04,000



**Illustration 39**

The progressive manufacturing company manufactures one main product and two by-products. Data for month are shown below:

Particulars	Main Product	By-Product A	By Product B
Sales	1,50,000	12,000	7,000
<b>MANUFACTURING COST:</b>			
(a) Before separation	75,000	—	—
(b) After separation	23,000	2,200	1,800
Administration cost	12,000	1,500	1,000
Ratio of Distribution of			
Selling cost	85%	10%	5%
Net profit in sales	20%	15%	10%

Assuming no beginning and ending inventories, apportion the joint cost among main product and the byproducts.

**Solution:****Calculation of Selling Expenses**

Particulars	Amount (₹)
Sales of 3 products	1,69,000
(-) Profit (30,000 + 1,800 + 700)	(32,500)
Total Cost	1,36,500
(-) Joint & Separate cost (75,000 + 27,000)	(1,02,000)
	34,500
(-) Administration cost	14,500
Selling Expenses	20,000

**Statement showing apportionment of Joint Expenditure**

	Particulars	Main Product	By Product A	By Product B	Total
(i)	Sales	1,50,000	12,000	7,000	1,69,000
(ii)	Profit	30,000	1,800	700	32,500
(iii)	Total cost (i – ii)	1,20,000	10,200	6,300	1,36,500
(iv)	Selling expenses	17,000 (85%)	2,000 (10%)	1,000 (5%)	20,000
(v)	Cost of production	1,03,000	8,200	5,300	1,16,500
(vi)	Administration cost	12,000	1,500	1,000	14,500
(vii)	Manufacturing cost (V-VI)	91,000	6,700	4,300	1,02,000
(viii)	Separate expenses	23,000	2,200	1,800	27,000
(ix)	Share of joint expenses (VII – VIII)	68,000	4,500	2,500	75,000

**Illustration 40**

In a factory producing joint products of two varieties, the following data are extracted from the books:

	<b>TOTAL (₹)</b>
Sales of products X and Y	7,50,000
Direct Material	2,25,000
Direct Labour	1,10,000
Variable Overhead (150% on Labour)	1,65,000
Fixed Overhead	2,00,000

The analysis of sales reveals that the percentage of sale of product X is  $66\frac{2}{3}\%$ .

Management contemplates to process further joint products so that they could be sold at higher rates. Facilities for this are available. The additional expenditure for the further process and total sales anticipated at higher selling prices are given below. Make recommendations presenting the affect of the proposal.

	<b>PRODUCT X</b>	<b>PRODUCT Y</b>	<b>TOTAL</b>
Sales after further processing	6,00,000	3,00,000	9,00,000
Additional material	50,000	20,000	70,000
Additional direct labour	20,000	8,000	28,000

**Solution:**

		<b>Amount (₹)</b>		
	<b>Particulars</b>	<b>X</b>	<b>Y</b>	<b>Total</b>
(i)	Sales after further processing	6,00,000	3,00,000	9,00,000
(ii)	Sales at split off	5,00,000	2,50,000	7,50,000
(iii)	Incremental sales	1,00,000	50,000	1,50,000
(iv)	Incremental/Additional/further processing / Separate cost:			
	Material	50,000	20,000	70,000
	Labour	20,000	8,000	28,000
	Variable Overheads	30,000	12,000	42,000
(v)	Incremental Profit/Loss	--	10,000	10,000

It is recommended to further process Product Y because there is an incremental / additional profit ₹10,000 where as product X need not be further processed because there is no additional profit.

**Illustration 41**

A vegetable oil refining company obtains four products whose cost details are:

Joint costs of the four products: ₹ 8,29,600

Outputs : A - 5,00,000 litres; B -10,000 litres,C- 5,000 litres and D- 9,000 kgs.

Further processing costs: A ₹ 2,40,000; B ₹ 48,000, C-Nil and D-₹ 8,030.

The products can be sold as intermediates i.e., at split-off point without further processing. The sale prices are:

	As finished Product	As Intermediate
A ₹ Per litre	1.84	1.20
B ₹ Per litre	8.00	4.00
C ₹ per litre	6.40	6.40
D ₹ Per Kg.	26.67	24.00

- (a) Calculate the product-wise profit allocating joint costs on Net Realisable Values (NRV).  
 (b) Compare the profitability in selling the products with and without further processing.

**Solution:**

**(a) Statement showing computation of profit after further processing** Amount (₹)

	Particulars	A	B	C	D	Total
(i)	Sales after further processing	9,20,000	80,000	32,000	2,40,030	12,72,030
(ii)	Separate / further costs	2,40,000	48,000	--	8,030	2,96,030
(iii)	Sales at split off (being NRV) (I-II)	6,80,000	32,000	32,000	2,32,000	9,76,000
(iv)	Joint costs (NRV basis)	5,78,000	27,200	27,200	1,97,200	8,29,600
(v)	Profit	1,02,000	4,800	4,800	34,800	1,46,400

**Statement Showing Computation of Profit Before Further Processing** Amount (₹)

	Particulars	A	B	C	D	Total
(I)	Sales at split off	6,00,000	40,000	32,000	2,16,000	8,88,000
(II)	Joint costs as apportioned above	5,78,000	27,200	27,200	1,97,200	8,29,600
(III)	Profit (I – II)	22,000	12,800	4,800	18,800	58,400

**(b) Statement Showing Computation of Incremental or Additional Profit by Further Process** Amount (₹)

	Particulars	A	B	C	D	Total
(I)	Sales after further processing	9,20,000	80,000	32,000	2,40,030	12,72,030
(II)	Sales before further processing	6,00,000	40,000	32,000	2,16,000	8,88,000
(III)	Incremental or additional sales (I-II)	3,20,000	40,000	-	24,030	3,84,030
(IV)	Incremental cost	2,40,000	48,000	-	8,030	2,96,030
(III)	Additional Profit or Loss (III-IV)	80,000	(8,000)	-	16,000	88,000

Products A&D should be further process, because there is incremental profit and where as products B and C need not be further process.

**Alternative Method:****Statement Showing Computation of Profit Before Further Processing (on the basis of sales)**

Amount (₹)

	Particulars	A	B	C	D	Total
(I)	Sales before further processing/split off	6,00,000	40,000	32,000	2,16,000	8,88,000
(II)	Joint costs 8,29,000 x (6,00,000/8,88,000)	5,60,540	37,369	29,895	2,01,796	8,29,600
(III)	Profit	39,460	2,631	2,105	14,204	58,400

**Statement Showing Computation of Profit After Further Processing (on basis of sales)**

Amount (₹)

	Particulars	A	B	C	D	Total
(I)	Sales at split off	6,80,000	32,000	32,000	2,32,000	9,76,000
(II)	Joint costs as apportioned above.	5,60,540	37,369	29,895	2,01,796	8,29,600
(III)	Profit or Loss	1,19,460	(5,369)	2,105	30,204	1,46,400

**Illustration 42**

T Ltd., in the course of refining crude oil obtains four joint products A, B, C and D. The total cost till the split off point was ₹ 97,600. The output and sales in the year 2015 were as follows:

Product	Output (Balance)	Sales Amount (₹)	Separate Costs Amount (₹)
A	5,00,000	1,15,000	30,000
B	10,000	10,000	6,000
C	5,000	4,000	—
D	9,000	30,000	1,000

You are required:

- Calculate the net income for each of the products if the joint costs are apportioned on the basis of sales value of the different products.
- What would be the net income of the company from each product if it decides to sell the products at the split off point itself A@ ₹15 paise, B @ ₹ 50 paise, C @ ₹ 80 paise and D @ ₹ 3 per gallon.
- In case the company expects to operate at the same level of production and sales in the year 2012 could the company increase the net income by altering its processing decisions? If so, what would be the expected overall net income? Which product should be sold at split off? Assume that all costs incurred after the split -off are variable.

**Solution:****Statement Showing Computation of Profit After Further Processing:****Amount (₹)**

	Particulars	A	B	C	D	Total
(I)	Sales at further processing	1,15,000	10,000	4,000	30,000	1,59,000
(II)	Separate cost	30,000	6,000	--	1,000	37,000
(III)	Sales at Split off (I) - (II)	85,000	4,000	4,000	29,000	1,22,000
(IV)	Joint Costs (On basis of NRV)	68,000	3,200	3,200	23,200	97,600
(V)	Profit (III) - (IV)	17,000	800	800	5,800	24,400

**Statement Showing Computation of Profit Before Further Processing:****Amount (₹)**

	Particulars	A	B	C	D	Total
(I)	Sales at split off	75,000	5,000	4,000	27,000	1,11,000
(II)	Joint Cost (as apportioned above)	68,000	3,200	3,200	23,200	97,600
(III)	Profit (I) - (II)	7,000	1,800	800	3,800	13,400

**Statement Showing Computation Of Incremental Profit By Further Processing****Amount (₹)**

	Particulars	A	B	C	D	Total
(I)	Sales after further process	1,15,000	10,000	4,000	30,000	1,59,000
(II)	Sales at split off (I) - (II)	75,000	5,000	4,000	27,000	1,11,000
(III)	Incremental sales	40,000	5,000	--	3,000	48,000
(IV)	Incremental/Separate costs	30,000	6,000	--	1,000	37,000
(V)	Incremental Profit (loss) (III) - (IV)	10,000	(1,000)	--	2,000	11,000

Product 'A' and 'D' should be further processed because there is additional profit where as product 'B' and 'C' need not be further processed because there is no additional profit.

**Computation of Profit by implementing decision:****Amount (₹)**

Profit from A	=	17,000
Profit from B	=	1,800
Profit from C	=	800
Profit from D	=	<u>5,800</u>
	=	<u>25,400</u>

**Illustration 43**

Beauty soap, company manufactures four different brands of soaps namely Komal, Lovely, Makeup and Nice. The data on production and sale of these brands during 2015 is reproduced below.

Brand Name	Komal	Lovely	Makeup	Nice
Production & Sales (units)	3,00,000	5,00,000	70,000	40,000
Sale value (₹ Lakhs)	15	31	2.8	1.2

All the above soaps are manufactured jointly up to a particular process. At split off point they are formed into cake-sand packed. The annual cost data were as under.



Direct Material Cost	₹ 30 lakhs
Value added	₹ 20 lakhs
(includes profit at 25% on total cost)	

Out of the above brands, Make up is sold in unpacked condition without further processing while other 3 brands further processed at an additional cost:

Komal	₹1,20,000	
Lovely	₹1,30,000	and
Nice	₹ 50,000	

You are required to:-

- Work out the profit and cost of each brand of soap after allocating joint cost on the basis of Net Realisable value at split up point. (per unit cost not required).
- Find out revised cost and profit on each brand if the company decides to sell all soaps at split up point at following prices; Komal ₹ 4.50; Lovely ₹6.00; Make up ₹ 4.00 and Nice ₹ 1.50 per unit.  
Assume that for allocation of joint cost net Realisable value method is used.
- With the working results in (a) and (b) above advise Beauty Soap Company about the processing decision as to which soap to be sold at split of point and which to be processed further so as to maximise profit. Substantiate your decision with suitable costing technique.

**Solution:**

#### Computation of Joint Cost

Particulars	Amount (₹)
Direct material	30,00,000
(+) value added	20,00,000
Total Sales	50,00,000
(-) Profit @ 25% on cost (i.e. 20% on sales)	10,00,000
Total Cost	40,00,000
(-) Separate Cost (120 + 130 + 50)	3,00,000
Joint Cost	37,00,000

#### Statement Showing Computation of Profit After Further Processing Amount (₹)

	Particulars	K	L	M	N	Total
(I)	Sales after further processing	15,00,000	31,00,000	2,80,000	1,20,000	50,00,000
(II)	Separate cost	1,20,000	1,30,000	-	50,000	3,00,000
(III)	Sales before further processing NRV= (I-II)	13,80,000	29,70,000	2,80,000	70,000	47,00,000
(IV)	Joint Costs (on basis of NRV)	10,86,383	23,38,085	2,20,426	55,106	37,00,000
(V)	Profit or Loss (III-IV)	2,93,617	6,31,915	59,574	14,894	10,00,000



**Statement Showing Computation of Profit Before Further Processing** **Amount (₹)**

	Particulars	K	L	M	N	Total
(I)	Sales at split off	13,50,000	30,00,000	2,80,000	60,000	46,90,000
(II)	Joint Cost (as apportioned above)	10,86,383	23,38,085	2,20,426	55,106	37,00,000
(III)	Profit or Loss	2,63,617	6,61,915	59,574	4,894	9,90,000

**Statement Showing Computation of Incremental Profit By Further Processing** **Amount (₹)**

	Particulars	K	L	M	N	Total
(I)	Sales after further process	15,00,000	31,00,000	2,80,000	1,20,000	50,00,000
(II)	Sales before further process	13,50,000	30,00,000	2,80,000	60,000	46,90,000
(III)	Incremental sales (I-II)	1,50,000	1,00,000	-	60,000	3,10,000
(IV)	Separate costs	1,20,000	1,30,000	-	50,000	3,00,000
(V)	Incremental Profit (loss) (III-IV)	30,000	(30,000)	-	10,000	10,000

Products K and N are to be further Process and whereas Products L and M need not to be further process

#### Illustration 44

In the course of manufacture of the main product 'P' by products 'A' and 'B' also emerge. The joint expenses of manufacture amount to ₹ 1,19,550. All the three products are processed further after separation and sold as per details given below:

	Main product	By products	
	P	A	B
Sales	90,000	60,000	40,000
Cost incurred after separation	6,000	5,000	4,000
Profit as percentage on sales	25	20	15

Total fixed selling expenses are 10% of total cost of sales which are apportioned to the three products in the ratio of 20 : 40 : 40.

- Prepare a statement showing the apportionment of joint costs to the main product and the two by products.
- If the by-product A is not subjected to further processing and is sold the point of separation for which there is a market, at ₹58,500 without incurring any selling expenses. Would you advise its disposal at this stage. Show the workings.

#### Solution:

**(a) Statement showing computation of share of joint expenses** **Amount (₹)**

	Particulars	Main Product P	By Product A	By Product B	Total
(i)	Sales	90,000	60,000	40,000	1,90,000
(ii)	Profit	22,500	12,000	6,000	40,500
(iii)	Cost of sales (I - II)	67,500	48,000	34,000	1,49,500
(iv)	Selling expenses	2,990	5,980	5,980	14,950
(v)	Manufacturing cost (III - IV)	64,510	42,020	28,020	1,34,550
(vi)	Separate costs	6,000	5,000	4,000	15,000
(vii)	Share of joint expenses (V - VI)	58,510	37,020	24,020	1,19,550



	<b>Amount (₹)</b>
Sales at split off (A)	= 58,500
(-) Joint Cost (A)	= <u>37,020</u>
	= <u>21,480</u>

(b) It is better to sell By-Product 'A' at split off point because it gives more profit ₹ 21,480 against profit after processing ₹ 12,000.

#### Illustration 45

"If the products are truly joint products the cost of the process can be applied to these products".

- (i) On the basis of the weight or other physical quantity of each product.
- (ii) In respect of the marginal cost of the process on the basis of physical quantities and in respect of fixed costs of the process on the basis of the contribution made by the various products.
- (iii) On the basis of selling values of the different products

Illustrate the above statement by using the following figures in respect of joint production of A and B for a month.

TOTAL COST:	Direct Material	5,000
	Direct labour	3,000
	Variable Overheads	2,000
	Fixed Overheads	2,000
	Sales ——— A 100 Qtls.	₹ 80 per qtl
	Sales ——— B 150 Qtls.	₹ 40 per qtl

#### Solution:

#### Computation of Profit by Distributing Joint Costs on the basis of Weight

Amount (₹)

	Particulars	A	B	Total
(i)	Sales	8,000	6,000	14,000
(ii)	Costs (100 : 150)	4,800	7,200	12,000
(iii)	Profit / (Loss)	3,200	(1,200)	2,000

#### Computation of Profit by Distributing Variable Cost on the Basis of Weight & Fixed Cost on basis of Contribution

Amount (₹)

	Particulars	A	B	Total
(i)	Sales	8,000	6,000	14,000
(ii)	Variable costs (100 : 150)	4,000	6,000	10,000
(iii)	Contribution	4,000	--	4,000
(iv)	Fixed cost	2,000	--	2,000
(v)	Profit	2,000	--	2,000



**Computation of Profit by distribution on the basis of Sales :****Amount (₹)**

	Particulars	A	B	Total
(i)	Sales	8,000	6,000	14,000
(ii)	Total cost	6,857	5,143	12,000
(iii)	Profit	1,143	857	2,000

### 5.5 OPERATING COSTING OR SERVICE COSTING – TRANSPORT, HOTEL AND HOSPITAL

**Operating or Service Costing**

Cost Accounting has been traditionally associated with manufacturing companies. However in the modern competitive market, cost accounting has been increasingly applied in service industries like banks, insurance companies, transportation organizations, electricity generating companies, hospitals, passenger transport and railways, hotels, road maintenance, educational institutions, road lighting, canteens, port trusts and several other service organizations. The costing method applied in these industries is known as 'Operating Costing'.

According to CIMA [London] operating costing is, '*that form of operating costing which applies where standardized services are provided either by an undertaking or by a service cost center within an undertaking*'.

**Nature of Operating Costing**

The main objective of operating costing is to compute the cost of the services offered by the organization. For doing this, it is necessary to decide the unit of cost in such cases. The cost units vary from industry to industry. For example, in goods transport industry, cost per ton kilometer is to be ascertained while in case of passenger transport, cost per passenger kilometer is to be computed. Cost units used in different service units are explained in detail later in chapter. The next step is to collect and identify various costs under different headings.

The headings used are,

- (a) Fixed or standing charges
- (b) Semi-fixed or maintenance charges
- (c) Variable or running charges.

One of the important features of operating costing is that mostly such costs are fixed in nature. For example, in case of passenger transport organization, most of the costs are fixed while few costs like diesel and oil are variable and dependent on the kilometers run.

Because of the diverse nature of activities carried out in service undertakings, the cost system used is obviously different from that of manufacturing concern. Let us discuss the method of computing costs in various service organisations .

**TRANSPORT ORGANISATION**

Costing in a transport industry consists of determining the operating cost of each vehicle and applying this cost to find out the cost per unit of service rendered by a vehicle. The cost unit is selected with proper care keeping in view the needs of each concern, the weight, bulk, volume and type of goods carried and distance covered in each trip. Transport undertakings include goods transport organizations as well as passenger transport organizations. The cost unit is either ton kilometer or passenger kilometer. The meaning is cost of carrying one ton over a distance of one kilometer or cost of carrying one passenger for a distance of one kilometer.



**Collection of Costs:** A log book is maintained for each vehicle to record details of trips made by the vehicle during a specified period of time. Log book is maintained usually on a daily basis. The details shown in the log book enables the management to make suitable allocation of vehicles, to avoid the duplicate trips, or to avoid idle running capacity. The log book also provides the information relating to the fuel consumed, distance travelled, no of hours travelled, chargeable kilo meters. The log book provide the data for proper allocation of cost and in this respect these may be compared with the production details available in a manufacturing concern

### Classification of Costs

The costs of a transport organisation can be classified and accumulated under the following heads:-

- (a) *Fixed or stand-by costs:* These costs which include garage charges, insurance, taxes, license, depreciation, wages of drivers, cleaner's salary, establishment cost of workshop and office. Out of the above some of the costs are directly identifiable for each vehicle such as license fee and some are apportioned such as office expenses
- (b) *Maintenance Charges:* These costs are in the nature of semi-variable nature includes expenditure on maintenance, repairs, tyres, tubes and other charges.
- (c) *Operating and Running costs:* These costs are variable in nature, includes fuel, lubricating oil, wages of drivers / cleaners (if paid on per trip / kilometer). These costs can be easily identifiable with each of the vehicle.

### Significance of Operating or Running Costs

- (i) Control of operating and running cost and avoidance of waste of fuel and other consumable material.
- (ii) Cost of running own vehicles may be compared with the hired or other forms of transport.
- (iii) Facilitates quotation of hiring rates to outside parties who ask for the transport service.
- (iv) If transport service is treated as a separate department or service cost center, the costs to be charged to the requesting department may be easily determined.
- (v) Suitable information is obtained for efficient routing of vehicles.
- (vi) Cost of idle vehicles and lost running time is easily obtained.

### Illustration 46

There are two warehouses for storing finished goods produced in a factory. Warehouse 'A' is at a distance of 10 kms. and Warehouse 'B' is at a distance of 15 kms from the factory. A fleet of 5 tonne lorries is engaged in transporting the finished goods from the factory. The records show that the lorries average a speed of 30 kms. per hour when running and regularly take 40 minutes to load at the factory. At warehouse 'A' unloading takes 30 minutes per load while at warehouse 'B' it takes 20 minutes per load.

Drivers' Wages, depreciation, insurance and taxes amount to ₹18 per hour operated. Fuel oil, tyres, repairs and maintenance cost ₹ 2.40 per kilometer. You are required to draw up a statement showing the cost per tonne kilometer of carrying the finished goods to the two warehouses.

**Solution:****Statement showing computation of total cost and cost per tonne kilometer of carrying finished goods to warehouses:**

Particulars		A	B
Time for travelling		40 Min	60 Min
Time for loading		40 Min	40 Min
Time for unloading		30 Min	20 Min
		110 Min	120 Min
Cost of Insurance, wages, tax, etc.	[(110/60) x 18] [(120/60) x 18]	33.00	36.00
Fuel & oil etc.	(20 x 2.4) (30 x 2.4)	₹ 48.00	₹ 72.00
Total Cost		₹ 81.00	₹ 108.00
Tonne Kilometers (5 x 10) (5 x 15)		₹ 50.00	₹ 75.00
Cost per tonne KM		₹ 1.62	₹ 1.44

**Illustration 47**

A transport service company is running 4 buses between two towns which are 50 miles apart. Seating capacity of each bus is 40 passengers. The following particulars were obtained from their books for April, 2015.

	Amount (₹)
Wages of Drivers, Conductors and Cleaners	2,400
Salaries of Office and Supervisory Staff	1,000
Diesel and oil and other oil	4,000
Repairs and Maintenance	800
Taxation, Insurance, etc.	1,600
Depreciation	2,600
Interest and Other Charges	<u>2,000</u>
	<u>14,400</u>

Actual passengers carried were 75% of the seating capacity. All the four buses ran on all days of the month. Each bus made one round trip per day. Find out the cost per passenger mile.

**Solution:****Computation of Cost per Passenger Mile**

$$\begin{aligned}
 \text{Passenger miles} &= \text{No. of buses} \times \text{Distance} \times \text{Round trip} \times \text{No. of Passengers} \times \text{No. of days in month} \times \text{Capacity} \\
 &= 4 \times 50 \times 2 \times 40 \times 30 \times 75\% \\
 &= 3,60,000 \text{ miles} \\
 \text{Cost per passenger mile} &= 14,400 / 3,60,000 \\
 &= ₹ 0.04
 \end{aligned}$$

**Illustration 48**

Mr. Sohan Singh has started transport business with a fleet of 10 taxies. The various expenses incurred by him are given below:

- (i) Cost of each taxi ₹ 75,000
- (ii) Salary of office Staff ₹ 1,500 p.m.
- (iii) Salary of Garage's Supervisor ₹ 2,000 p.m.
- (iv) Rent of Garage ₹ 1,000 p.m
- (v) Drivers Salary (per taxi) ₹ 400 pm.
- (vi) Road Tax and Repairs per taxi ₹ 2,160 p.a.
- (vii) Insurance premium @ 4% of cost p.a.

The life of a taxi is 3,00,000 km. and at the end of which it is estimated to be sold at ₹ 15,000. A taxi runs on an average 4,000 Km. per month of which 20% it runs empty, petrol consumption 9 Km. per litre of petrol costing ₹ 6.30 per litre. Oil and other sundry expenses amount to ₹ 10 per 100 Km.

Calculate the effective cost of running a taxi per kilometre. If the hire charge is ₹ 1.80 per Kilometre, find out the profit that Mr. Shoan may expect to make in the first year of operation.

**Solution:****Statement Showing Computation of Effective Cost and Profit for the Year**

Particulars	Amount (₹)	Amount (₹)
<b>Fixed expenses:</b>		
Salary of staff	1,500	
Salary of garage supervisor	2,000	
Rent of garage	1,000	
Driver Salary (10 x 400)	4,000	
Road tax and repairs (2,160 x 10/12)	1,800	
Insurance premium (75,000 x 4 % x 10/12)	2,500	12,800
Fixed cost of 10 taxi's per month		
Cost per taxi = ₹ 12,800/10 = ₹ 1,280		
Cost per km = 1280/4,000 = 0.32		0.32
<b>Running Costs:</b>		
Depreciation [(75,000-15,000) / 3,00,000]		0.20
Petrol (6.3/9)		0.70
Oil & sundry expenses (10/100)		0.10
		1.32
Effective cost per Km = 1.32 x (100/80)		1.65

$$\begin{aligned} \text{Profit for year} &= (1.80 - 1.65) \times 10 \times 3,200 \times 12 \\ &= ₹ 57,600 \end{aligned}$$

**Illustration 49**

Janata Transport Co. has been given a route 20 km. long for running buses. The company has a fleet of 10 buses each costing ₹ 50,000 and having a life of 5 years without any scrap value.

From the following estimated expenditure and other details calculate the bus fare to be charged from each passenger.

(i) Insurance charges	3 %	p.a.
(ii) Annual tax for each bus	₹ 1,000	
(iii) Total garage charges	₹1,000	
(iv) Drivers' salary for each bus	₹150	p.m
(v) conductor's salary for each bus	₹100	p.m
(vi) Annual repairs to each bus	₹1,000	
(vii) Commission to be shared by the driver and conductor equally: 10% of the takings		
(viii) Cost of stationary	₹500	p.m.
(ix) Manager's salary	₹2,000	p.m.
(x) Accountant's salary	₹1,500	p.m.
(xii) Petrol and oil	₹25	per 100 km

Each bus will make 3 round trips carrying on an average 40 passengers on each trip. The bus will run on an average for 25 days in a month. Assuming 15% profit on takings, calculate, the bus fare to be charged from each passenger.

**Solution:**

Particulars	Amount (₹)
Insurance (50,000 x 3% x 10/12)	1,250
Tax (1,000 x 10/12)	833.33
Garage charges	1,000
Drivers salary (150 x 10)	1,500
Conductor salary (100 x 10)	1,000
Repairs (1,000 x 10/12)	833.33
Cost of stationary	500
Managers salary	2,000
Accountant salary	1,500
Depreciation (50,000 x 10/5 x 1/12)	833.33
Petrol * (30,000/100) x 25	7,500
Commission of conductor & driver 35,000 x (10/100)	3,500
	29,750
(+) Profit @ 15% on takings (35,000 x 15/100)	5,250
	35,000

$$* 10 \times 20 \times 3 \times 2 \times 25 = 30,000$$

Let 'X' be the takings

$$X = 26,250 + (10/100 X) + (15/100 X)$$

$$100 X = 26,25,000 + 25 X$$



$$\Rightarrow X = 35,000$$

$$\begin{aligned} \text{Fare per passenger Km} &= 35,000 / (30,000 \times 40) \\ &= 0.0292 = ₹ 0.03 \end{aligned}$$

**Illustration 50**

Union Transport Company supplies the following details in respect of a truck of 5 tonne capacity

Cost of truck	₹ 90,000	
Estimated life	10 years	
Diesel, oil, grease	₹ 15 per trip each way	
Repairs and maintenance	₹500 p.m.	
Driver's wages	₹ 500 p.m.	
Cleaner's wages	₹ 250 p.m.	
Insurance	₹ 4,800	per year
Tax	₹2,400	per year
General supervision charges	₹4,800	per year

The truck carries goods to and from the city covering a distance of 50 kms. each way.

On outward trip freight is available to the extent of full capacity and on return 20% of capacity.

Assuming that the truck runs on an average 25 days a month, work out:

- Operating cost tonne-km.
- Rate for tonne per trip that the company should charge if a profit of 50% on freight is to be earned.

**Solution:**

Particulars	Amount (₹)
Repairs & Maintenance	500
Drivers wages	500
Cleaners wages	250
Insurance	400
Tax	200
Supervision charge	400
Depreciation [(90,000/10) x (1/12)]	750
Diesel, oil, grease (15 x 2 x 25)	750
	3,750
(+) 50% profit on freight (100% on cost)	3,750
	7,500

$$\begin{aligned} \text{Tonne Kms} &= 25 [(50 \times 5) + (20/100 \times 50 \times 5)] \\ &= 7,500 \end{aligned}$$

$$\begin{aligned} \text{Cost per tonne km} &= 3,750 / 7,500 = 0.50 \\ \text{(+) Profit @ 50% on freight} &= 0.50 \\ &= 1.00 \end{aligned}$$

## HOTELS

Service costing is an effective tool in respect of hotel industry which run on commercial basis. Hence it is necessary to compute the cost in order to determine the price of various services provided by the hotel and to find out the profit or loss at the end of a particular period.

In this case, the costs associated with different services offered may be identified and cost per unit may be worked out. The cost unit may be Guest-day or room-day. For calculation of cost per guest day or room day, estimated occupancy rate at different point of time are taken into account, for example, peak season or lean season.

### Illustration 51

XYZ Ltd. runs a holiday home. For this purpose, it has hired a building at a rent of ₹10,000 per month along with 5% of total taking. It has three types of suites for its customers, viz., single room, double rooms and triple rooms.

Following information is available:

Type of suite	Number	Percentage of occupancy
Single room	100	100%
Double rooms	50	80%
Triple rooms	30	60%

The rent of double rooms suite is to be fixed at 2.5 times of the single room suite and that of triple rooms suite as twice of the double rooms suite.

The other expenses for the year 2018 are as follows:

Particulars	₹
Staff salaries	14,25,000
Room attendants' wages	4,50,000
Lighting, heating and power	2,15,000
Repairs and renovation	1,23,500
Laundry charges	80,500
Interior decoration	74,000
Sundries	1,53,000

Provide profit @ 20% on total taking and assume 360 days in a year.

Calculate the rent to be charged for each type of suite.

### Solution:

### Working Notes:

#### Total equivalent single room suites

Nature of suite	Occupancy (Room-days)	Equivalent single room suite (Room- days)
Single room suites	36,000 (100 rooms × 360 days × 100%)	36,000 (36,000 × 1)
Double rooms suites	14,400 (50 rooms × 360 days × 80%)	36,000 (14,400 × 2.5)
Triple rooms suites	6,480 (30 rooms × 360 days × 60%)	32,400 (6,480 × 5)
		1,04,400



## Statement of total cost

Particulars	₹
Staff salaries	14,25,000
Room attendants' wages	4,50,000
Lighting, heating and power	2,15,000
Repairs and renovation	1,23,500
Laundry charges	80,500
Interior decoration	74,000
Sundries	1,53,000
Building rent {(Rs.10,000 × 12 months) + 5% on total taking}	25,21,000
	1,20,000 + 5% on total takings
Total cost	26,41,000 + 5% on total takings

Profit is 20% of total takings

∴ Total takings = ₹ 26,41,000 + 25% (5% + 20%) of total takings

Let R be rent for single room suite

Then 1,04,400 R = 26,41,000 + (0.25 × 1,04,400 R)

Or, 1,04,400 R = 26,41,000 + 26,100 R

Or, 78,300 R = 26,41,000

Or, R = ₹ 33.73

**Rent to be charged:**

Rent to be charged for single room suite = ₹ 33.73

Rent for double rooms suites = ₹ 33.73 × 2.5 = ₹ 84.33

Rent for triple room suites = ₹ 33.73 × 5 = ₹ 168.65

**Illustration 52**

Angel Holiday Home runs in a small hill station with 100 single rooms. The home offers concessional rates during six off season months in a year. During this period, half of the full room rent is charged. The management's profit margin is targeted at 20% of the room rent. The following are the cost estimates and other details for the year ending on 31st March 2018 [Assume a month as 30 days].

- Occupancy during the season is 80% while in the off- season it is 40% only.
- Total investment in the home is ₹ 200 lakhs of which 80% relate to buildings and balance for furniture and equipment.
- Expenses:

Particulars	₹
Staff salary [Excluding room attendants]	5,50,000
Repairs to building	2,61,000
Laundry charges	80,000
Interior	1,75,000
Miscellaneous expenses	1,90,800



Annual depreciation is to be provided for buildings @ 5% and on furniture and equipment @ 15% on straight-line basis.

- (v) Room attendants are paid ₹10 per room day on the basis of occupancy of the rooms in a month.  
 (vi) Monthly lighting charges are ₹120 per room, except in four months in winter when it is ₹ 30 per room and this cost is on the basis of full occupancy for a month.

You are required to work out the room rent chargeable per day both during the season and the off-season months on the basis of the foregoing information.

### Solution:

#### Working Notes

#### Total Room days in a year

Season	Occupancy (Room-days)	Equivalent Full Room charge days)
Season – 80% occupancy	100 Rooms × 80% × 6 months × 30 days in a month = 14,400 Room Days	14,400 Room Days × 100% = 14,400
Off-season – 40% occupancy	100 Rooms × 40% × 6 months × 30 days in a month = 7,200 Room Days	7,200 Room Days × 50% = 3,600
Total Room days	14,400 + 7,200 = 21,600 Room Days	18,000 Full Room days

#### Lighting Charges

It is given in the question that lighting charges for 8 months is ₹120 per month and during winter season of 4 months it is ₹ 30 per month. Further it is also given that peak season is 6 months and off season is 6 months.

Being Hill station, winter season is to be considered as part of off-season. Hence, the non-winter season of 8 months include: peak season of 6 months and off-season of 2 months.

Hence, the lighting charges are calculated as follows:

Season	Occupancy (Room-days)
Season & Non-winter – 80% Occupancy	100 Rooms × 80% × 6 months × ₹120 per month = ₹57,600
Off-season & Non-winter – 40% Occupancy (8 – 6 months)	100 Rooms × 40% × 2 months × ₹120 per month = ₹9,600
Off-season & winter – 40% Occupancy months	100 Rooms × 40% × 4 months × ₹30 per month = ₹4,800
Total Lighting charges	₹57,600 + 9,600 + 4,800 = ₹72,000

#### Statement of total cost

Particulars	₹
Staff salary	5,50,000
Repairs to building	2,61,000
Laundry & Linen	80,000
Interior	1,75,000
Sundries Expenses	1,90,800



Depreciation on Building (₹ 200 Lakhs × 80% × 5%)	8,00,000
Depreciation on Furniture & Equipment (₹ 200 Lakhs × 20% × 15%)	6,00,000
Room attendant's wages (Rs.10 per Room Day for 10,800 Room Days )	1,08,000
Lighting charges	72,000
<b>Total cost</b>	<b>28,36,800</b>
Add: Profit Margin (20% on Room rent or 25% on Cost)	7,09,200
<b>Total Rent to be charged</b>	<b>35,46,000</b>

**Calculation of Room Rent per day:**

Total Cost/ Equivalent Full Room days = ₹35,46,000/18,000 = ₹197.00

Room Rent during Season – ₹197

Room Rent during Off-season = ₹197 × 50% = ₹ 98.50

**HOSPITALS**

Hospitals provide various types of medical services to the patients. Hospital costing is applied to determine the cost of these services. A hospital may have different departments catering to very many services to the patients - such as

- Out-Patient
- In-Patient
- Medical services like X-Ray, Scanning, etc.
- General services like Catering, Laundry, Power house, etc.
- Miscellaneous services like Transport, Pharmacy, etc.

**Unit of Cost**

Common unit of costs of various departments are as follows:

- Out-Patient - Per Out-Patient
- In-Patient - Per Room Day
- Scanning - Per Case
- Laundry - Per 100 items laundered

**Segregation of Cost**

The cost of hospital can be divided into fixed costs and variable costs

Fixed costs are based on timelines and irrespective of services rendered. For example, Staff salaries, Depreciation on Building and Equipment, etc

Variable costs vary with the level of services rendered. For example, Laundry charges, Cost of food supplied to patients, Power, etc.

**Illustration 53**

Zenith Hospital runs a Critical Care Unit (CCU) in a hired building. CCU consists of 35 beds and 5 more beds can be added, if required.

Rent per month: ₹75,000

Supervisors - 2 persons @ ₹ 25,000 per month each

Nurses - 4 persons @ ₹20,000 per month each

Ward Boys - 4 persons @ ₹5,000 per month each

Doctors were paid ₹250,000 per month on the basis of number of patients attended and the time spent by them.

Other expenses for the year are as follows:

Repairs (fixed) – ₹87,000

Food to patients (variable) – ₹8, 80,000

Other services to patients (variable) – ₹3,00,000

Laundry charges (variable) – ₹6,00,000

Medicines (variable) – ₹7,50,000

Other fixed expenses – ₹10, 80,000

Administration expenses allocated – ₹10,00,000

It was estimated that for 150 days in a year 35 beds are occupied and 25 beds are occupied for 80 days only.

The hospital hired 750 beds at a charge of ₹100 per bed per day to accommodate the flow of patients. However, this does not exceed more than 5 extra beds over and above the normal capacity of 35 beds on any day.

You are required to -

- Calculate profit per Patient day, If the hospital recovers on an average ₹2,000 per day from each patient
- Find out Break-even point for the hospital.

**Solution:**

**Working Notes:**

**Calculation of number of patient days**

35 Beds × 150 days	=	5,250
25 Beds × 80 days	=	2,000
Extra beds	=	750
<b>Total</b>		<b>8,000</b>

**Profitability Statement**

Particulars	Amount (₹)	Amount (₹)
<b>Income for the year</b> (₹ 2,000 per patient per day × 8,000 patient days)		<b>1,60,00,000</b>
<b>Less: Variable Costs:</b>		
Doctor Fees (₹ 2,50,000 per month × 12)	30,00,000	
Food to Patients (variable)	8,80,000	
Other services to patients (variable)	3,00,000	
Laundry charges (variable)	6,00,000	
Medicines (variable)	7,50,000	
Bed Hire Charges (₹100 × 750 beds)	75,000	
<b>Total variable costs</b>		<b>56,05,000</b>
<b>Contribution</b>		<b>1,03,95,000</b>
<b>Less : Fixed Costs :</b>		
Rent (Rs.75,000 per month × 12)	9,00,000	
(Supervisor (2 persons × ₹ 25,000 × 12)	6,00,000	
Nurses (4 persons × ₹ 20,000 × 12)	9,60,000	
Ward Boys (4 persons × ₹ 5,000 × 12)	2,40,000	
Repairs (fixed)	81,000	
Other fixed expenses	10,80,000	
Administration expenses allocated	10,00,000	
<b>Total Fixed Costs</b>		<b>48,61,000</b>
<b>Profit</b>		<b>55,34,000</b>

**Calculation of Contribution per Patient day**

Total Contribution = ₹1,03,95,000

Total Patient days = 8,000

Contribution per Patient day = ₹1,03,95,000 / 8,000 = ₹1,299.375

**Breakeven Point = Fixed Cost / Contribution per Patient day**

= ₹ 48, 61,000 / ₹1,299.375

= 3,741 patient days

**Illustration 54**

Manar lodging home is being run in a small hill station with 50 single rooms. The home offers concessional rates during six off- season months in a year. During this period, half of the full room rent is charged. The management's profit margin is targeted at 20% of the room rent. The following are the cost estimates and other details for the year ending on 31st March 2016. [Assume a month to be of 30 days].

- (i) Occupancy during the season is 80% while in the off- season it is 40% only.
- (ii) Expenses:
  - Staff salary [Excluding room attendants] ₹ 2,75,000
  - Repairs to building ₹ 1,30,500
  - Laundry and linen ₹ 40,000
  - Interior and tapestry ₹ 87,500
  - Sundry expenses ₹ 95,400
- (iii) Annual depreciation is to be provided for buildings @ 5% and on furniture and equipments @ 15% on straight-line basis.
- (iv) Room attendants are paid ₹ 5 per room day on the basis of occupancy of the rooms in a month.
- (v) Monthly lighting charges are ₹ 120 per room, except in four months in winter when it is ₹ 30 per room and this cost is on the basis of full occupancy for a month.
- (vi) Total investment in the home is ₹ 100 lakhs of which ₹ 80 lakhs relate to buildings and balance for furniture and equipments.

You are required to work out the room rent chargeable per day both during the season and the off-season months on the basis of the foregoing information.

**Solution:****(i) Computation of Estimated Cost for the year ending 31<sup>st</sup> March, 2016**

Particulars	Amount (₹)
Salary	2,75,000
Repairs	1,30,500
Laundry and linen	40,000
Interior decoration	87,500
Depreciation: 5% on ₹ 80 lakhs: ₹ 4,00,000 15% on ₹ 20 lakhs: ₹ 3,00,00	7,00,000
Sundry expenses	95,400
Total costs	13,28,400



(ii) Number of room days in a year:

Occupancy during season for 6 months @ 80%  $(50 \times 0.80 \times 6 \times 30) = 7,200$

Off-season occupancy for 6 months @ 40%  $(50 \times 0.40 \times 6 \times 30) = 3,600$

Total number of room days during a year = 10,800

(iii) Attendant's salary

For 10,800 room days @ ₹ 5 per day = ₹ 54,000

(iv) Light charges for 8 months @ ₹ 120 per month i.e. ₹ 120/30 = ₹ 4 per room day.

Light charges for 4 months @ ₹ 30 per month, i.e. ₹ 30/30 = ₹ 1 per room day

Total lighting charges:

During season @ ₹ 4 for 7200 days = ₹ 28,800

During off season 2 months @ ₹ 4 for 1200 days  $(2/6 \times 3600) = ₹ 4,800$

During 4 months of winter @ Re. 1 for 2,400 days  $(4/6 \times 3600) = ₹ 2,400$

**Note:**

It is given in the example that during four months of winter, the lighting is ₹ 30 per room, which is 1/4<sup>th</sup> of the lighting charges during the remaining period of the year. Hence the rate of room day which is ₹ 4 will also be 1/4<sup>th</sup> for winter period and so it is taken as Re. 1 per room day.

**Statement of Total Estimated Cost**

Particulars	Amount (₹)
Expenses as shown in I above	13,28,000
Attendant's salary as shown in III above	54,000
Lighting charges as shown in IV above	36,000
Total cost	14,18,400

Computation of total Full Room Days

During season : 7,200

Off-season : 1,800 (Equivalent to 50% rate of 3,600 days)

Total Full Room Days : 9,000

Computation of Room Rent

Cost per room day : ₹ 14,18,400 / 9,000 = ₹ 157.60

Add: Profit margin at 20% of rent or 25%

Of cost = ₹ 39.40

Room Rent = ₹ 197.00

Therefore, during season, room rent of ₹ 197 is to be charged while in the off-season room rent of ₹ 98.50 is to be charged.



## GLOSSARY

**Abnormal Process Gain:** Abnormal process gain is an unexpected gain in production under the normal conditions due to over-estimation of process loss, improvements in work efficiency of workers, use of better technology in production etc.

**Abnormal Process Loss:** Abnormal process loss is the loss in excess of the predetermined loss (normal process loss) due to carelessness of workers, a bad plant design or operation, sabotage etc. Such a loss cannot obviously be estimated in advance.

**Batch Costing:** Batch Costing is that form of specific order costing under which each batch is treated as a cost unit and costs are accumulated and ascertained separately for each batch. Each batch consists of a number of like units. This type of costing is applied to a manufacturing organisation where similar articles are produced in batches either for sale or for use within the organisation. It is similar to Job Costing.

**By-product:** By-product is the product which is recovered incidentally from the material used in the manufacture of main products. The by-product has either a net realisable value which is relatively low as compared to the saleable value of the main products.

**Contract Costing:** Contract Costing is a form of specific order costing applicable to a construction company where work is undertaken according to customers' requirements and each order is of long duration. It is similar to Job Costing.

**Cost of Work Uncertified:** Cost of work uncertified represents the cost of the work which has been carried out by the contractor but has not been certified by the expert.

**Economic Batch Quantity (EBQ):** Economic Batch Quantity refers to the optimum quantity batch which should be produced at a point of time so that the set up & processing costs and carrying costs are together optimised.

**Equivalent Units:** Equivalent units are the notional quantities of completed units substituted for the actual quantities of incomplete physical units in progress, when the aggregate work content of the incomplete units is deemed to be equivalent to that of the substituted quantity of completed units, e.g. 100 units 50% complete is equivalent to 50 completed units.

**Escalation Clause:** Escalation clause is a clause in a contract which empowers a contractor to revise the price of the contract in case of increase in the prices of inputs due to some macro-economic or other agreed reasons.

**Job Costing:** Job Costing is a form of specific order costing applicable to an organisation where work is undertaken according to customers' requirements and each order is comparatively of short duration. According to CIMA, Job Costing is the category of basic costing methods which is applicable where the work consists of separate contracts, jobs or batches each of which is authorised by specific order or contract.

**Joint Costs:** Joint costs are the costs of providing two or more products or services whose production could not be segregated for physical reasons.

**Joint Products:** Joint products are the two or more products separated in the course of processing, each having a high saleable value to be considered as main product.

**Normal Process Loss:** Normal process loss is the loss of material which is inherent in the nature of work. It is unavoidable because of nature of the material or the process.



**Operating Costing:** CIMA defines operating costing as that form of operating costing which applies where standardised services are provided either by an undertaking or by a service cost center within an undertaking.

**Process Costing:** Process costing is one of the basic costing methods applicable to an organisation where goods result from a sequence of repetitive operations or processes to which costs are charged before being averaged over the units produced during the period.

**Retention Money:** Retention money is the portion of the value of work certified, which is kept by a contractee as security money for any loss or damage caused by the contractor.

**Value of Work Certified:** Value of work certified is the value of a contract which is certified by an expert in terms of percentage of total work.

**Theoretical Questions:**

1. Explain Job Costing and Batch Costing giving examples of Industries where these are used.
2. How is Economic Batch Quantity determined under Batch Costing System?
3. Distinguish between Joint products and By-products.
4. Describe briefly, how joint costs up to the point of separation may be apportioned amongst the joint products?
5. Write short notes on:
  - (a) Escalation clause
  - (b) Retention money
  - (c) Equivalent units
  - (d) Operating Costing

**MULTIPLE CHOICE QUESTIONS:**

1. Job costing is used in
  - A. Furniture making
  - B. Repair shops
  - C. Printing press
  - D. All of the above
2. In a job cost system, costs are accumulated
  - A. On a monthly basis
  - B. By specific job
  - C. By department or process
  - D. By kind of material used





3. The most suitable cost system where the products differ in type of material and work performed is
  - A. Operating Costing
  - B. Job costing
  - C. Process costing
  - D. All of these.
  
4. Cost Price is not fixed in case of
  - A. Cost plus contracts
  - B. Escalation clause
  - C. De escalation clause
  - D. All of the above
  
5. Most of the expenses are direct in
  - A. Job costing
  - B. Batch costing
  - C. Contact costing
  - D. None of the above
  
6. Cost plus contact is usually entered into those cases where
  - A. Cost can be easily estimated
  - B. Cost of certified and uncertified work
  - C. Cost of certified work, cost of uncertified work and amount of profit transferred to Profit and Loss Accounts.
  
7. In order to determine cost of the products or services, different business firms follow:
  - A. Different techniques of costing
  - B. Uniform Costing
  - C. Different method of costing
  - D. Note of the above
  - E. All of the above
  
8. In case product produced or jobs undertaken are of diverse nature, the system of costing to be used should be:
  - A. Operating Costing
  - B. Process Costing
  - C. Job costing
  - D. None of the above
  - E. All of the above



9. Job Costing is:
- A. Suitable where similar products are produced on mass-scale
  - B. Method of costing used for non-standard and non-repetitive products
  - C. Technique of costing
  - D. Applicable to all industries regardless of the products or services provided
  - E. None of the above
10. Batch costing is a type of:
- A. Direct costing
  - B. Process costing
  - C. Job costing
  - D. Differential costing
  - E. None of the above
11. Batch Costing is similar to that under job costing except with the difference that:
- A. Process becomes a cost unit
  - B. Job becomes a cost unit
  - C. Batch become the cost unit instead of a job
  - D. None of the above
  - E. All of the above
12. Economic batch quantity is that size of the batch of production where:
- A. Carrying cost is minimum
  - B. Set-up cost of machine is minimum
  - C. Average cost is minimum
  - D. Both A. and B.
  - E. None of the above
13. Job costing is similar to that under Batch costing except with the difference that:
- A. Batch becomes the cost unit instead of a job
  - B. Job becomes a cost unit
  - C. Process becomes a cost unit
  - D. None of the above
  - E. All of the above



14. Which of the following documents are used in job costing to record the issue of direct materials to a job:
- A. Purchase order
  - B. Purchase requisition
  - C. Goods received note
  - D. Material requisition
  - E. None of the above
15. Which of the following statements is true:
- A. Batch costing is a variant of jobs costing
  - B. Job cost sheet may be used for estimating profit of jobs
  - C. Job costing cannot be used in conjunction with marginal costing
  - D. In cost plus contracts, the contractor runs a risk of incurring a loss
16. Which of the following statements is true:
- A. Job costing can be suitably used for concerns producing any specific product uniformly
  - B. Job costing cannot be used in companies applying standard costing
  - C. Job cost sheet may be prepared to facilitate routing and scheduling of the job
  - D. Neither A. nor B. nor C.
17. Equivalent production of 1,000 units, 60% complete in all respects, is :
- A. 1000 units
  - B. 1600 units
  - C. 600 units
  - D. 1060 units
18. In a process 8000 units are introduced during a period. 5% of input is normal loss. Closing work in progress 60% complete is 1000 units. 6600 completed units are transferred to next process. Equivalent production for the period is:
- A. 9000 units
  - B. 7440 units
  - C. 5400 units
  - D. 7200 units
19. The type of process loss that should not be allowed to affect the cost of good units is called:
- A. Standard loss
  - B. Normal loss
  - C. Abnormal loss
  - D. Seasonal loss
  - E. None of the above



20. 400 units were introduced in a process in which 40 units is the normal loss. If the actual output is 300 units, then there is:
- A. No abnormal gain
  - B. Abnormal loss of 60 units
  - C. No abnormal loss
  - D. Abnormal gain of 60 units
  - E. None of the above
21. Spoilage that occurs under inefficient operating conditions and is generally controllable is called
- A. Normal defectives
  - B. Abnormal spoilage
  - C. Normal spoilage
  - D. None of the above
22. In which of the following situations an abnormal gain in a process occurs:
- A. When normal loss is equal to actual loss
  - B. When the actual output is greater than the planned output.
  - C. When actual loss is more than the expected
  - D. When actual loss is less than the expected loss
  - E. None of the above
23. The value of abnormal loss is equal to:
- A. Total cost of materials
  - B. Total process cost less cost of scrap
  - C. Total process cost less realisable value of normal loss less value of transferred out goods.
  - D. Total process cost less realisable value of normal loss
  - E. None of the above
24. A process account is debited by abnormal gain, the value is determined as:
- A. Equal to the value of goods units less closing stock
  - B. Equal to the value of normal loss
  - C. Cost of good units less realisable value of normal loss
  - D. Cost of goods units less realisable value of actual loss
  - E. None of the above



25. In sugar manufacturing industry molasses is also produced along with sugar. Molasses may be of smaller value as compared with the value of sugar and is known as:
- A. Joint product
  - B. Common product
  - C. By-product
  - D. None of them
26. Method of apportioning joint costs on the basis of output of each joint product at the point of split-offs is known as:
- A. Physical unit method
  - B. Sales value method
  - C. Average cost method
  - D. Marginal cost and contribution method
  - E. None of the above
27. The main purpose of a accounting of joint products and by-products is to:
- A. Determine the replacement cost
  - B. Determine the opportunity cost
  - C. Determine profit or loss on each product line
  - D. None of the above
28. Under net realisable value method of apportioning joint costs to joint products, the selling & distribution cost is:
- A. Ignored
  - B. Deducted from sales value
  - C. Deducted from further processing cost
  - D. Added to joint cost
  - E. None of the above
29. Which of the following is an example of by-product:
- A. Mustard seeds and mustard oil.
  - B. Diesel and Petrol in an oil refinery
  - C. Edible oils and oil cakes
  - D. Curd and butter in a dairy
  - E. All of the above



30. Which of following methods can be used when the joint products are of unequal quantity and used for captive consumption:
- A. Physical units method
  - B. Net realisable value method
  - C. Technical estimates, using market value of similar goods
  - D. Market value at split-off method
31. Cost of service under operating costing is ascertained by preparing:
- A. Cost sheet
  - B. Process account
  - C. Job cost sheet
  - D. Production account
32. Operating costing is applicable to:
- A. Hospitals
  - B. Cinemas
  - C. Transport undertaking
  - D. All of the above
33. Composite cost unit for a hospital is:
- A. Per day
  - B. Per bed
  - C. Per patient-day
  - D. Per patient
  - E. None of the above
34. Cost units used in power sector is called:
- A. Number of hours
  - B. Number of electric points
  - C. Kilowatt-hour(KWH)
  - D. Kilo meter (K. M)
  - E. All of the above
35. Absolute Tonne-km. is an example of:
- A. Composite unit for bus operation
  - B. Composite unit of transport sector
  - C. Composite unit for oil and natural gas
  - D. Composite unit in power sector
  - E. All of the above

[Ans: D, B, B, A, C, B, C, C, B, C, C, D, B, D, B, D, C, D, C, B, B, D, C, C, C, A, C, B, C, C, A, D, C, C, B]



**State whether the following statements are True or False:**

1. Operating costing is applied to ascertain the cost of products.
2. Cost of operating the service is ascertained by preparing job account.
3. The problem of equivalent production arises in case of operating costing.
4. FIFO methods are followed for evaluation of equivalent production when prices are fluctuating.
5. Work in progress is the inherent feature of processing industries.
6. Costs incurred prior to the split off point are known as "Joint Costs"
7. No distinction is made between Co products and Joint Products.
8. Contact costing is variant of job costing.
9. In contact costing, the unit of cost is a job.
10. Job costing is applied only in small concerns.

[Ans: F, F, F, F, T, T, F, T, F, F]

**Fill in the Blanks:**

1. Cost of \_\_\_\_ los is not borne by good units.
2. If the actual loss in a process is less than the normal loss, the difference is known as \_\_\_\_\_.
3. \_\_\_\_\_ Costs are incurred after split off point.
4. The \_\_\_\_ product generally has a greater sale value than by product.
5. Statement of cost per unit of equivalent production shows the per unit cost \_\_\_\_\_.
6. Two principle method of evaluation of equivalent production are \_\_\_\_\_ and \_\_\_\_\_.
7. In hospital the cost unit is \_\_\_\_\_.
8. In electricity companies, the cost unit is \_\_\_\_\_.
9. The method of costing used in undertaking like gas companies, cinema houses, hospitals etc is known as \_\_\_\_\_.
10. In motor transport costing two example of fixed cost are \_\_\_\_\_ and \_\_\_\_\_.

[Ans: Abnormal, Abnormal gain, Subsequent, main, Element wise, FIFO and Average method, per bed, Kilowatt, Operating costing, Insurance and Depreciation]

**Match the following:**

	<b>Column A</b>		<b>Column B</b>
1.	The contract which provide for payment of actual cost plus an agreed percentage of profit.	A.	Average price method
2.	In contract costing, the cost unit is	B.	Kilowatt
3.	Abnormal loss is transferred to	C.	Job costing
4.	Job costing is used in	D.	Normal Output
5.	Under job order cost system, each job is assigned one identifying job.	E.	Cost Plus
6.	Cost of normal loss is borne by	F.	Per bed
7.	Inherent features of process industry	G.	Per contract
8.	The method which is followed for evaluation of equivalent production when prices are fluctuating.	H.	Automobile garages
9.	In hospital the cost unit is	I.	Costing Profit and loss account
10.	In electricity companies, the cost unit is	J.	Work in progress

[Ans: E, G, I, H, C, D, J, A, F, B]





# Study Note - 6

## COST ACCOUNTING TECHNIQUES

### This Study Note includes

- 6.1 Marginal Costing
- 6.2 Standard Costing & Variance Analysis
- 6.3 Budget and Budgetary Control

### 6.1 MARGINAL COSTING

Marginal Cost is defined as "the amount at any given volume of output by which aggregate costs are changed if the volume of output is increased or decreased by one unit." Marginal Cost also means Prime Cost plus Variable Overheads. Marginal Cost also means Prime Cost plus Variable Overheads. Marginal Cost is a constant ratio which may be expressed in terms of an amount per unit of output. On the other hand, fixed cost which is not normally traceable to particular unit denotes a fixed amount of expenditure incurred during an accounting period. Fixed cost is, therefore, also called time cost, period cost, standby cost, capacity cost, or constant cost. Variable cost or marginal cost is also termed as direct cost, activity cost, volume cost or out-of-pocket cost.

From the above definition and analysis of marginal cost, we can understand that is the cost which varies according to the variations in the volumes of output. However, by definition marginal cost is the change in the total cost for addition of one unit. *It is to be noted that for an economist marginal cost and variable cost would be different. But for an accountant both marginal cost and variable cost are same and are interchangeably used.* Therefore, for our study, we use marginal cost and variable cost synonymously.

Marginal costing is "the ascertainment of marginal costs and of the effect on profit of changes in volume or type of output by differentiating between fixed costs and variable costs." Several other terms in use like direct costing, contributory costing, variable costing, comparative costing, differential costing and incremental costing are used more or less synonymously with marginal costing.

It is a process whereby costs are classified into fixed and variable and with such a division so many managerial decisions are taken. The essential feature of marginal costing is division of total costs into fixed and variable, without which this could not have existed. Variable costs vary with volume of production or output, whereas fixed costs remains unchanged irrespective of changes in the volume of output. It is to be understood that unit variable cost remains same at different levels of output and total variable cost changes in direct proportion with the number of units. On the other hand, total fixed cost remains same disregard of changes in units, while there is inverse relationship between the fixed cost per unit and the number of units.

#### Features of Marginal Costing

The main features of Marginal Costing may be summed up as follows:

1. Appropriate and accurate division of total cost into fixed and variable by picking out variable portion of semi variable costs also.
2. Valuation of stocks such as finished goods, work-in-progress is valued at variable cost only.



3. The fixed costs are written off soon after they are incurred and do not find place in product cost or inventories.
4. Prices are based on Marginal Cost and Marginal Contribution.
5. It combines the techniques of cost recording and cost reporting.

#### **Advantages or Merits or Applications of Marginal Costing**

1. Marginal costing system is simple to operate than absorption costing because they do not involve the problems of overhead apportionment and recovery.
2. Marginal costing avoids, the difficulties of having to explain the purpose and basis of overhead absorption to management that accompany absorption costing. Fluctuations in profit are easier to explain because they result from cost volume interactions and not from changes in inventory valuation.
3. It is easier to make decisions on the basis of marginal cost presentations, e.g., marginal costing shows which products are making a contribution and which are failing to cover their avoidable (i.e., variable) costs. Under absorption costing the relevant information is difficult to gather, and there is the added danger that management may be misled by reliance on unit costs that contain an element of fixed cost.
4. Marginal costing is essentially useful to management as a technique in cost analysis and cost presentation. It enables the presentation of data in a manner useful to different levels of management for the purpose of controlling costs. Therefore, it is an important technique in cost control.
5. Future profit planning of the business enterprises can well be carried out by marginal costing. The contribution ratio and marginal cost ratios are very useful to ascertain the changes in selling price, variable cost etc. Thus, marginal costing is greatly helpful in profit planning.
6. When a business concern consists of several units and produces several products and evaluation of performance of such components can well be made with the help of marginal costing.
7. It is helpful in forecasting.
8. When there are different products, the determination of number of units of each product, called Optimum Product Mix, is made with the help of marginal costing.
9. Similarly, optimum sales mix i.e., sales of each and every product to get maximum profit can also be determined with the help of marginal costing.
10. Apart from the above, numerous managerial decisions can be taken with the help of marginal costing, some of which, may be as follows:-
  - (a) Make or buy decisions,
  - (b) Exploring foreign markets,
  - (c) Accept an order or not,
  - (d) Determination of selling price in different conditions,
  - (e) Replace one product with some other product,
  - (f) Optimum utilisation of labour or machine hours,
  - (g) Evaluation of alternative choices,
  - (h) Subcontract some of the production processes or not,



- (i) Expand the business or not,
- (j) Diversification,
- (k) Shutdown or continue,

### Limitations of Marginal Costing

- a. The separation of costs into fixed and variable presents technical difficulties and no variable cost is completely variable nor is a fixed cost completely fixed.
- b. Under the marginal cost system, stock of finished goods and work-in-progress are understated. After all, fixed costs are incurred in order to manufacture products and as such, these should form a part of the cost of the products. It is, therefore, not correct to eliminate fixed costs from finished stock and work-in-progress.
- c. The exclusion of fixed overhead from the inventories affects the Profit and Loss Account and produces an unrealistic and conservative Balance Sheet, unless adjustments are made in the financial accounts at the end of the period.
- d. In marginal costing system, marginal contribution and profits increase or decrease with changes in sales volume. Where sales are seasonal, profits fluctuate from period to period. Monthly operating statements under the marginal costing system will not, therefore, be as realistic or useful as in absorption costing.
- e. During the earlier stages of a period of recession, the low profits or increase in losses, as revealed in a magnified way in the marginal costs statements, may unduly create panic and compel the management to take action that may lead to further depression of the market.
- f. Marginal costing does not give full information. For example, increased production and sales may be due to extensive use of existing equipments (by working overtime or in shifts), or by an expansion of the resources, or by the replacement of labour force by machines. The marginal contribution fails to reveal these.
- g. Though for short-term assessment of profitability marginal costs may be useful, long term profit is correctly determined on full costs basis only.
- h. Although marginal costing eliminates the difficulties involved in the apportionment and under and over-absorption of fixed overhead, the problem still remains so far as the variable overhead is concerned.
- i. With increased automation and technological developments, the impact on fixed costs on products is much more than that of variable costs. A system which ignores fixed costs is therefore, less effective because a major portion of the cost, such as not taken care of.
- j. Marginal costing does not provide any standard for the evaluation of performance. A system of budgetary control and standard costing provides more effective control than that obtained by marginal costing.

### Absorption Costing

In absorption costing the classification of expenses is based on functional basis but in marginal costing it is based on the nature of expenses. In absorption costing, the fixed expenses are distributed over products based on a pre-determined level of output. Since fixed expenses are constant, such a method of recovery will lead to over or under-recovery of expenses depending on the actual output being greater or lesser than the estimate used for recovery. This difficulty will not arise in marginal costing because the contribution is used as a resource for meeting fixed expenses.



The presentation of information to management under the two costing techniques is given below.

**Income Statement (Absorption costing)**

Particulars	(₹)	(₹)
<b>Sales</b>		-----
<b>Production Costs:</b>		
Direct material consumed		-----
Direct labour cost		-----
Variable manufacturing overhead		-----
Fixed manufacturing overhead		-----
<b>Cost of production</b>		-----
Add: Opening stock of finished goods		-----
(Value at cost of previous period's production)		-----
		-----
Less: Closing stock of finished goods		-----
(Value at production cost of current period)		-----
<b>Cost of Goods Sold</b>		-----
Add: (or less) Under (or over) absorption of Fixed Manufacturing overhead		-----
Add: Administration costs	-----	
Add: Selling and distribution costs	-----	-----
<b>Total Cost</b>		-----
<b>Profit (Sales – Total cost)</b>		-----

**Income Statement (Marginal costing)**

Particulars	(₹)
<b>Sales</b>	-----
<b>Variable manufacturing costs:</b>	
- Direct material consumed	-----
- Direct labour	-----
- Variable manufacturing overhead	-----
<b>Cost of Goods Produced</b>	-----
Add: Opening stock of finished goods	
(Value at cost of previous period)	-----
Less: Closing stock of finished goods	
(Value at current variable cost )	-----
<b>Cost of Goods Sold</b>	-----
Add: Variable administration, Selling and distribution overhead	-----
<b>Total Variable Cost</b>	-----
Add: Selling and distribution costs	-----
<b>Contribution (Sale – Total variable costs)</b>	-----
Less: Fixed costs (production, admin, selling and dist.)	-----
<b>Net profit</b>	-----



It is observed from the above that under marginal costing technique the contributions of various products are pooled together and the fixed overheads are met out of such total contribution. The total contribution is also known as gross margin. The contribution minus fixed expenses gives net profit.

**Limitations of Absorption Costing**

1. Being dependent on levels of output which vary from period to period, costs are vitiated due to the existence of fixed overhead. This renders them useless for purposes of comparison and control. (If, however, overhead recovery rate is based on normal capacity, this situation will not arise).
2. Carryover of a portion of fixed costs, i.e., period costs to subsequent accounting periods as part of the cost of inventory is a unsound practice because costs pertaining to a period should not be allowed to be vitiated by the inclusion of costs pertaining to the previous period.
3. Profits and losses in the accounts are related not only to sales but also to production, including the production which is unsold. This is contrary to the principle that profits are made not at the stage when products are manufactured but only when they are sold.
4. There is no uniformity in the methods of application of overhead in absorption costing. These problems have, no doubt, to be faced in the case of marginal costing also but to a less extent because of the exclusion of fixed costs, as different assumptions made in the matter of application of fixed overhead will not arise in the case of marginal costing.
5. Absorption costing is not always suitable for decision making solutions to various types of problems of management decision making, where the absorption cost method would be practically ineffective, such as selection of production volume and optimum capacity utilisation, selection of production mix, whether to buy or manufacture, choice of alternatives and evaluation of performance can be had with the help of marginal cost analysis. Sometimes, the conclusion drawn from absorption cost data in this regard may be misleading and lead to losses.

**Differences between Absorption Costing and Marginal Costing**

	<b>Absorption Costing</b>	<b>Marginal Costing</b>
1.	Both fixed and variable costs are considered for product costing and inventory valuation.	Only variable costs are considered for product costing and inventory valuation.
2.	Fixed costs are charged to the cost of production. Each product bears a reasonable share of fixed cost and thus the profitability of a product is influenced by the apportionment of fixed costs.	Fixed costs are regarded as period costs. The profitability of different products is judged by their P/V ratio.
3.	Cost data are presented in conventional pattern. Net profit of each product is determined after subtracting fixed cost along with their variable cost.	Cost data are presented to highlight the total contribution of each product.
4.	The difference in the magnitude of opening stock and closing stock affects the unit cost of production due to the impact of related fixed cost.	The difference in the magnitude of opening stock and closing stock does not affect the unit cost of production.
5.	In case of absorption costing the cost per unit reduces, as the production increases as it is fixed cost which reduces, whereas, the variable cost remains the same per unit.	In case of marginal costing the cost per unit remains the same, irrespective of the production as it is valued at variable cost.

**Difference in profit under Marginal and Absorption Costing**

- No opening and closing stock: In this case, profit/loss under absorption and marginal costing will be equal.
- When opening stock is equal to closing stock: In this case, profit/loss under two approaches will be equal provided the fixed cost element in both the stocks is same amount.
- When closing stock is more than opening stock: In other words, when production during a period is more than sales, then profit as per absorption approach will be more than that by marginal approach. The reason behind this difference is that a part of fixed overhead included in closing stock value is carried forward to next accounting period.
- When opening stock is more than the closing stock: In other words when production is less than the sales, profit shown by marginal costing will be more than that shown by absorption costing. This is because a part of fixed cost from the preceding period is added to the current year's cost of goods sold in the form of opening stock.

**Illustration 1**

MAXWEL Ltd. produces a single product Boost. The following figures relate to Boost for the period: 2017-2018.

Activity Level	50%	100%
Sales and production (units)	400	800
	(₹)	(₹)
Sales	8,00,000	16,00,000
Production costs:		
- Variable	3,20,000	6,40,000
- Fixed	1,60,000	1,60,000
Selling and distribution costs:		
- Variable	1,60,000	3,20,000
- Fixed	2,40,000	2,40,000

The normal level of activity for the year is 800 units. Fixed costs are incurred evenly throughout the year, and actual fixed costs are the same as budgeted. There were no stocks of Boost at the beginning of the year.

In the first quarter, 220 units were produced and 160 units were sold.

**Required:**

- What would be the fixed production costs absorbed by Boost if absorption costing is followed?
- What would be the under/over-recovery of overheads during the period?
- What would be the profit as per absorption costing?
- What would be the profit as per marginal costing?



**Solution:**

**Fixed production costs absorbed**

Particulars	(₹)
Budgeted fixed production costs	1,60,000
Budgeted output (normal level of activity 800 units)	
Therefore, the absorption rate: $1,60,000/800 = ₹ 200$ per unit	
During the first quarter, the fixed production cost absorbed by Boost would be (220 units × ₹ 200)	44,000

**Under/over-recovery of overheads during the period**

Particulars	(₹)
Actual fixed production overhead (1/4 of ₹ 1,60,000)	40,000
Absorbed fixed production overhead	44,000
Over-recovery of overheads	4,000

**Profit for the Quarter (Absorption Costing)**

Particulars	(₹)	(₹)
Sales revenue (160 units × ₹ 2,000): (A)		3,20,000
Less: Production costs:		
- Variable cost (220 units × ₹ 800)	1,76,000	
- Fixed overheads absorbed (220 units × ₹ 200)	44,000	2,20,000
Add: Opening Stock		----
Less: Closing Stock (₹ 2,20,000/220 units × 60 units)		(60,000)
Cost of Goods sold		1,60,000
Less: Adjustment for over-absorption of fixed production overheads		(4,000)
Less: Selling & Distribution Overheads:		
-Variable (160 units × ₹ 400)	64,000	
- Fixed (1/4 <sup>th</sup> of ₹ 2,40,000)	60,000	1,24,000
Cost of Sales (B)		2,80,000
Profit {(A) – (B)}		40,000

**Profit for the Quarter (Marginal Costing)**

Particulars	(₹)	(₹)
Sales revenue (160 units × ₹ 2,000): (A)		3,20,000
Less: Production costs:		
- Variable cost (220 units × ₹ 800)		1,76,000
Add: Opening Stock		----
Less: Closing Stock (₹ 1,76,000/220 units × 60 units)		(48,000)



Variable cost of goods sold		1,28,000
Add: Selling & Distribution Overheads:		
-Variable (160 units × Rs.400)		64,000
Cost of Sales (B)		1,92,000
Contribution {(C) = (A) – (B)}		1,28,000
Less: Fixed Costs:		
- Production cost	(40,000)	
- Selling & distribution cost	(60,000)	(1,00,000)
Profit		28,000

### Differential Cost Analysis

Differential Cost is the change in the costs which results from the adoption of an alternative course of action. The alternative actions may arise due to change in sales volume, price, product mix (by increasing, reducing or stopping the production of certain items), or methods of production, sales, or sales promotion, or they may be due to 'make or buy' or 'take or refuse' decisions. When the change in costs occurs due to change in the activity from one level to another, differential cost is referred to as incremental cost or decremental cost, if a decrease in output is being considered, i.e. total increase in cost divided by the total increase in output. However, accountants generally do not distinguish between differential cost and incremental cost and the two terms are used to mean one and the same thing.

The computation of differential cost provides an useful method of analysis for the management for anticipating the results of any contemplated changes in the level or nature of activity. When policy decisions have to be taken, differential costs worked out on the basis of alternative proposals are of great assistance.

The determination of differential cost is simple. Differential cost represents the algebraic difference between the relevant costs for the alternatives being considered. Thus, when two levels of activities are being considered, the differential cost is obtained by subtracting the cost at one level from the cost of another level.

#### The essential features of differential costs are as follows:-

1. The basis data used for differential cost analysis are costs, revenue and the investment factors which are relevant in the problem for which the analysis is undertaken.
2. Total differential costs rather than the costs per unit are considered.
3. Differential cost analysis is made outside the accounting records.
4. As the differences in the costs at two levels are considered, absolute costs at each level are not as relevant as the difference between the two. Thus, items of costs which do not change but are identical for the alternatives under consideration, are ignored.
5. The differentials are measured from a common base point or position.
6. The stage at which the difference between the revenue and the cost is the highest, measured from the common base point, determines the choice from amongst a number of alternative actions.
7. In computing differential costs, historical or standard costs may be used but they should be adjusted to the requirements of future conditions.
8. The elements and items of cost to be considered in differential cost analysis will depend upon the nature of the problem and the alternatives being considered.





### Differential Costs Analysis and Marginal Costing

Although the techniques of differential costs analysis are similar to those of marginal costing, the two should not be confused. The points of similarity and difference between differential costs analysis and marginal costing are summarized below:

#### Similarity

- a. Both the techniques of cost analysis and cost presentation.
- b. Both are made use of by the management in decision making and in formulating policies.
- c. The concepts of differential costs and marginal costs mainly arise out of the difference in the behaviour of fixed and variable costs.
- d. Differential costs compare favourably with the economist's definition of marginal cost, viz. that marginal cost is the amount which at any given volume of output is changed if output is increased or decreased by one unit.

#### Difference

- a. Differential cost analysis can be made in the case of both absorption costing as well as marginal costing.
- b. While marginal costing excludes the entire fixed costs, some of the fixed costs may be taken into account as being relevant for the purpose of differential cost analysis.
- c. Marginal costs may be embodied in the accounting system whereas differential costs are worked out separately as analysis statements.
- d. In marginal costing, margin of contribution and contribution ratio are the main yardsticks for performance evaluation and for decision making. In differential cost analysis, differential costs are compared with the incremental or decremental revenues, as the case may be.

#### Practical Application of Differential Costs

They are useful in managerial decisions, which are enumerated below:

- (i) Determination of most profitable levels of production and price
- (ii) Acceptance of offer at a lower price or offering a quotation at lower selling price in order to increase capacity
- (iii) It is used to decide whether it will be more profitable to sell a product as it is or to process it further into a different product to be sold at an increased price
- (iv) Determining the suitable price at which raw material may be purchased
- (v) Decision of adding a new product or business segment
- (vi) Discontinuing a product or business segment in order to avoid or reduce the present loss or increase profit
- (vii) Changing the product mix
- (viii) Make or buy decisions
- (ix) Decision regarding alternative capital investment and plant replacement
- (x) Decision regarding change in method of production



## Tools and Techniques of Marginal Costing

### 1. Contribution

In common parlance, contribution is the reward for the efforts of the entrepreneur or owner of a business concern. From this, one can get in his mind that contribution means profit. But it is not so. Technically or in Costing terminology, contribution means not only profit but also fixed cost. That is why; it is defined as the amount recovered towards fixed cost and profit.

Contribution can be computed by subtracting variable cost from sales or by adding fixed costs and profit.

Symbolically,  $C = S - V \rightarrow (1)$

Where  $C =$  Contribution

$S =$  Selling Price

$V =$  Variable Cost

Also  $C = F + P \rightarrow (2)$

Where  $F =$  Fixed Cost

$P =$  Profit

From (1) and (2) above, we may deduce the following equation called Fundamental Equation of Marginal Costing i.e.

$S - V = F + P \rightarrow (3)$

Contribution is helpful in determination of profitability of the products and/or priorities for profitabilities of the products. When there are two or more products, the product having more contribution is more profitable.

For example: The following are the three products with selling price and cost details:

Particulars	A	B	C
Selling price (₹)	100	150	200
Variable cost (₹)	50	70	100
Contribution (₹)	50	80	100

In the above example, one can say that the product 'C' is more profitable because, it has more contribution. This proposition of product having more contribution is more profitable is valid, as long as, there are no limitations on any factor of production. In this context, factors of production means, the factors that are responsible for producing the products such as material, labour, machine hours, demand for sales etc.,

### Limiting Factor (or) Key Factor

In the above example, we find that product having more contribution is more profitable. However, when there is a limitation on any input factor, the profitability of the product cannot simply be determined by finding out the contribution of the unit, but it can be found out by ascertaining the contribution per unit of that factor of production which is limited in the given situation. Such factor of production which is limited in the question is called key factor or limiting factor.



Continuing the above example, it may be explained as follows:

The three products take same raw material. A takes 1 kg, B requires 2 kgs, C requires 5 kgs and the raw material is not abundant.

Then profitability of the above products is determined as follows:

$$\text{Profitability} = \left( \frac{\text{Contribution}}{\text{Key Factor}} \right)$$

A	B	C
50 / 1 = ₹ 50	80 / 2 = ₹ 40	100 / 5 = ₹ 20

Now, product A is more profitable because it has more contribution per kg of material.

The key factor can also be called as scarce factor or Governing factor or Limiting factor or Constraining factor etc., whatever may be the name, it indicates the limitation on the particular factor of production.

From the above, it is essentially understandable that contribution is helpful in determination of profitability of the products, priorities for profitability of the products and in particular, profitabilities when there are limitation on any factor.

## 2. Profit Volume Ratio (P/V Ratio) or Contribution Ratio

First of all, a ratio is a statistical or mathematical tool with the help of which a relationship can be established between the variables of the same kind. Further, it may be expressed in different forms such as fractional form, quotient, percentage, decimal form, and proportional form.

For example:

**Gross profit ratio:** It may be expressed as follows:

- Gross profit is ¼th of sales
- Sales is 4 times that of gross profit
- Gross profit ratio is 25%
- Gross profit is 0.25 of sales and lastly
- Gross profit and sales are in the ratio of 1:4

So, P/V ratio or contribution ratio is association of two variables. From this, one may assume that it is the ratio of profit and sales. But it is not so. It is the ratio of Contribution to Sales.

$$\text{Symbolically P/V ratio} = \frac{\text{Contribution}}{\text{Sales}} \times 100 \rightarrow (1)$$

$$\Rightarrow \text{P/V ratio} = \frac{C}{S} \times 100$$

$$\Rightarrow \text{Contribution} = \text{Sales} \times \text{P/V ratio} \rightarrow (2)$$

$$\Rightarrow \text{Sales} = \frac{\text{Contribution}}{\frac{P}{V} \text{ Ratio}} \rightarrow (3)$$



When cost accounting data is given for two periods, then:

$$P/V \text{ ratio} = \frac{\text{Change in Contribution}}{\text{Change in Sales}} \times 100$$

$$P/V \text{ ratio} = \frac{\text{Change in Profit}}{\text{Change in Sales}} \times 100$$

It is to be noted that the above two formulas are valid as long as there are no changes in prices, means input prices and selling prices.

Usually, Sales = Cost + Profit

i.e. it can also be written as Sales = Variable Cost + Fixed Cost + Profit and this is called general sales equation.

Since Sales consists of variable costs and contribution, given the variable cost ratio, P/V ratio can be found out. Similarly, given the P/V ratio, variable cost ratio can be found out.

For example, P/V ratio is 40%, then variable cost ratio is 60%, given variable cost ratio is 70%, then P/V ratio is 30%. Such a relationship is called complementary relationship. Thus P/V ratio and variable cost ratios are said to be complements of each other.

P/V ratio is also useful like contribution for determination of profitabilities of the products as well as the priorities for profitabilities of the products. In particular, it is useful in determination of profitabilities of the products in the following two situations:

- i. When sales potential in value is limited.
- ii. When there is a greater demand for the products.

### Break Even Point

When someone asks a layman about his business he may reply that it is alright. But a technical man may reply that it is break even. So, Break Even means the volume of production or sales where there is no profit or loss. In other words, Break Even Point is the volume of production or sales where total costs are equal to revenue. It helps in finding out the relationship of costs and revenues to output. In understanding the breakeven point, cost, volume and profit are always used. The break even analysis is used to answer many questions of the management in day to day business.

The formal break even chart is as follows:

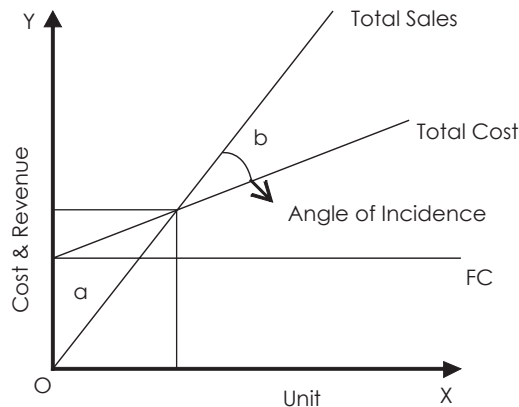

a = Losses

b = Profits

When no. of units are expressed on X-axis and costs and revenues are expressed on Y-axis, three lines are drawn i.e., fixed cost line, total cost line and total sales line. In the above graph we find there is an intersection point of the total sales line and total cost line and from that intersection point if a perpendicular is drawn to X-axis, we find break even units. Similarly, from the same intersection point a parallel line is drawn to X-axis so that it cuts Y-axis, where we find Break Even point in terms of value. This is how, the formal pictorial representation of the Break Even chart.

At the intersection point of the total cost line and total sales line, an angle is formed called *Angle of Incidence*, which is explained as follows:

**Angle of Incidence**

Angle of Incidence is an angle formed at the intersection point of total sales line and total cost line in a formal break even chart. If the angle is larger, the rate of growth of profit is higher and if the angle is lower, the rate of growth of profit is lower. So, growth of profit or profitability rate is depicted by Angle of Incidence.

**Break Even Analysis (or) Cost-Volume-Profit Analysis (CVP analysis)**

From the breakeven charts breakeven point and profits at a glance can be found out. Besides, management makes profit planning with the help of breakeven charts. It can clearly be understood by way of charts to know the changes in profit due to changes in costs and output. Such profit planning is made with the variables mainly cost, profit and volume, such an analysis is called breakeven analysis. Throughout the charts relationship is established among the cost, volume and profit, it is also called *Cost-Volume-Profit Analysis (CVP analysis)*. That is why it is popularly said by S.C.Kuchal in his book “*Financial Management - An Analytical and Conceptual Approach*”, that **Cost-volume-profit analysis, break even analysis and profit graphs are interchangeable words**. The analysis is further explained as follows:

The change in profit can be studied through Break even charts in different situations in the following manner:

**(i) Increase in No. of Units**

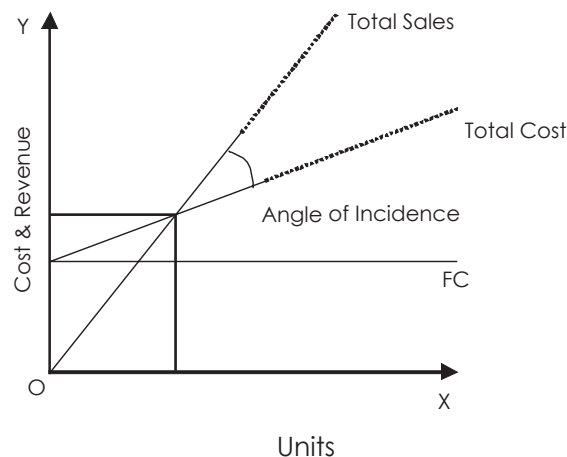

'.....' line indicates increase in total cost and total sales.

In the above chart, if we clearly observe we find that there is no change in BEP even if there is increase or decrease in No. of units.



**(ii) Increase in Sales due to increase in selling price.**

NTS = New Total Sales line

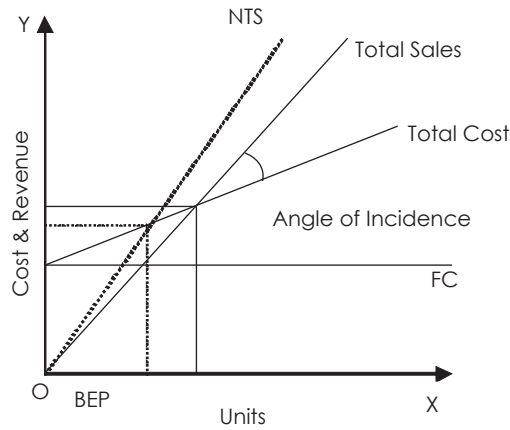

'.....' line indicates changes in break even point and changes in sales.

From the above chart, we observe that profit is increased by increasing the selling price and also, if there is change in selling price, BEP also changes. If selling price is increased then BEP decreases. If selling price is decreased then BEP increases. Thus, we say that there is an inverse relationship between selling price and BEP.

**(iii) Decrease in variable cost**

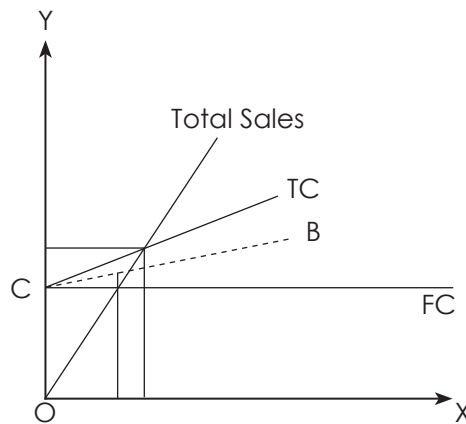

'CB' line indicates decrease in total cost and decrease in B.E.P

From the above chart, we observe that when variable costs are decreased, no doubt, profit is increased. If there is change in variable cost then BEP also changes. If variable cost is decreased then BEP also decreases. If variable cost is increased then BEP also increases. Thus there is direct relationship between variable cost and BEP.

**(iv) Change in fixed cost**

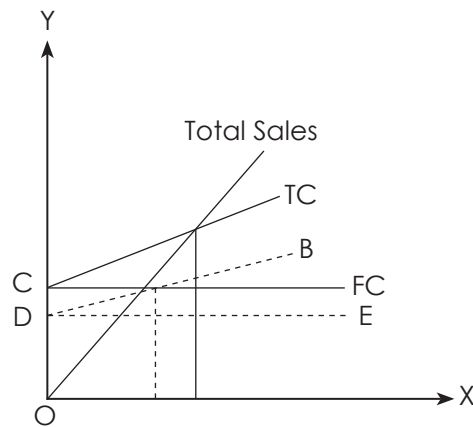

'DE and DB' line indicate decrease in fixed cost and total cost respectively and consequent decrease in BEP.

From the above chart also we find that there is increase in profit due to decrease in fixed cost. If fixed cost is increased then BEP also increases. If fixed cost is decreased then BEP also decreases. Thus there is a direct relationship between fixed cost and BEP.

**Non linear Break Even Chart**

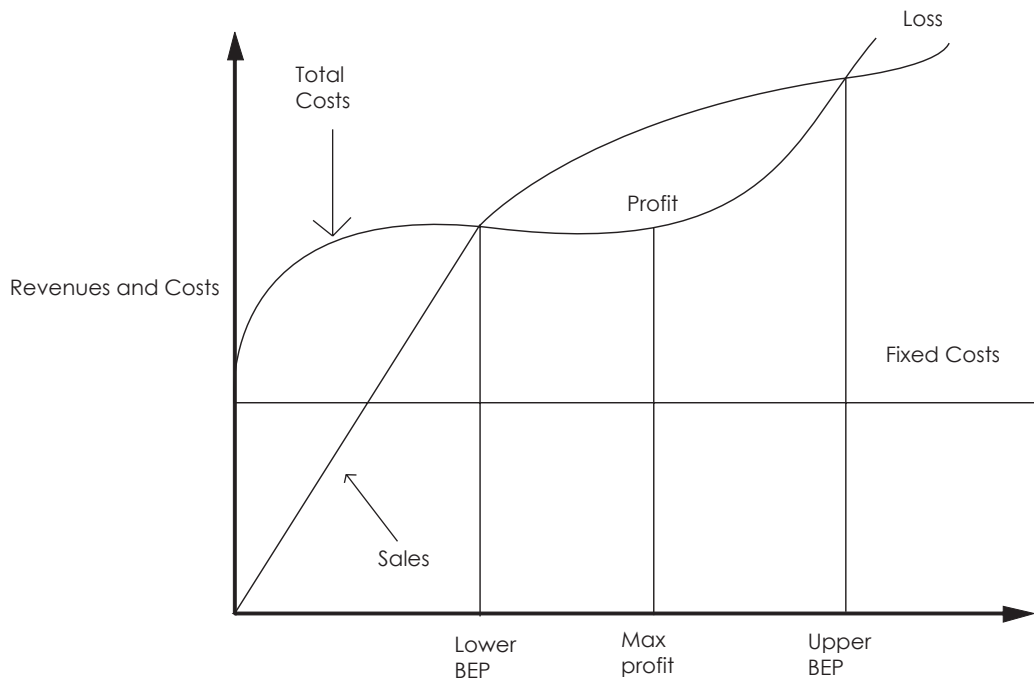

In some cases on account of non-linear behaviour of cost and sales there may be two or more break even points. In such a case the optimum profit is earned where the difference between the sales and the total costs is the largest. It is obvious that the business should produce only upto this level. This is being illustrated in the above chart.

**Contribution Breakeven Chart**

A contribution breakeven chart is based on the same principles as a conventional breakeven chart except for that it shows the variable cost line instead of the fixed cost line. Lines for total cost and sales revenue remain the same. The breakeven point and profit can be read in the same way as with a conventional chart. It is also possible to read the contribution for any level of activity.

Contribution breakeven chart is shown below:

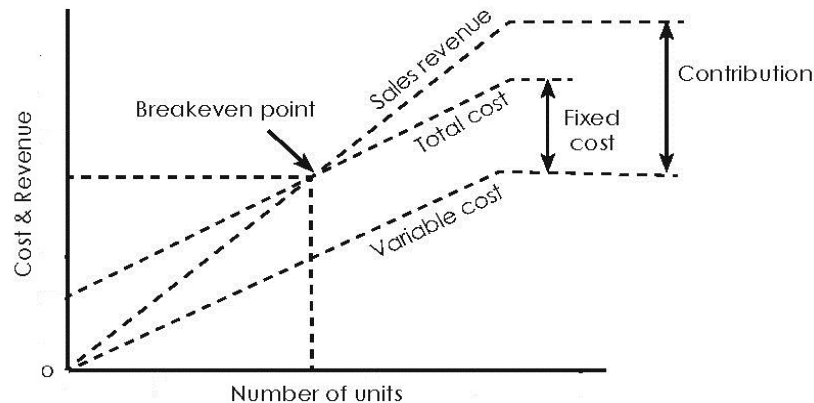

The contribution can be read as the difference between the sales revenue line and the variable cost line.

**Cash Break-Even Point**

When break-even point is calculated only with those fixed costs which are payable in cash, such a break-even point is known as cash break-even point. This means that depreciation and other non-cash fixed costs are excluded from the fixed costs in computing cash break-even point. Its formula is-

Cash break even point = Cash fixed costs / Contribution per unit.

**COMPUTATION OF BREAK EVEN POINT:**

$$\text{Break Even Point in value} = \frac{F \times S}{S - V} \quad \dots (1)$$

$$= \frac{F \times S}{C} \quad \dots (2)$$

$$= \frac{F \times S}{F + P} \quad \dots (3)$$

$$= \frac{F}{\text{P.V. Ratio}} \quad \dots (4)$$

$$\text{or} = \frac{F}{\frac{C}{S}}$$

$$\text{or} = \frac{F}{\frac{S - V}{S}}$$

$$= \frac{F}{1 - \frac{V}{S}} \quad \dots (5)$$

Break Even Point (in units) = Fixed Cost / Contribution per unit





### Proof for basic breakeven

Let, V be the variable cost per unit

U be the volume of output i.e., No. of units

P be the Profit

F be the Fixed Cost

S be the Selling Price

By substituting the notations in general sales equation:

Sales = Fixed cost + Variable cost + Profit

$$SU = F + VU + P$$

At Break Even,  $SU = F + VU$  (Since  $P = 0$ )

$$\rightarrow SU - VU = F$$

$$\rightarrow U(S - V) = F$$

$$\rightarrow U = \frac{F}{S - V}$$

OR

$$\text{No. of Units} = \frac{\text{Fixed Cost}}{\text{Contribution per Unit}}$$

Break even sales

$$SU (\text{Sales}) = \frac{F \times S}{S - V}$$

### Uses and applications of Break even Analysis (Or) Profit Charts (Or) Cost Volume Profit Analysis

The important uses to which cost-volume profit analysis or break-even analysis or profit charts may be put to use are:

- Forecasting costs and profits as a result of change in Volume determination of costs, revenue and variable cost per unit at various levels of output
- Fixation of sales Volume level to earn or cover given revenue, return on capital employed, or rate of dividend
- Determination of effect of change in Volume due to plant expansion or acceptance of order, with or without increase in costs or in other words, determination of the quantum of profit to be obtained with increased or decreased volume of sales
- Determination of comparative profitability of each product line, project or profit plan
- Suggestion for shift in sales mix
- Determination of optimum sales volume
- Evaluating the effect of reduction or increase in price, or price differentiation in different markets
- Highlighting the impact of increase or decrease in fixed and variable costs on profit
- Studying the effect of costs having a high proportion of fixed costs and low variable costs and vice-versa
- Inter-firm comparison of profitability



- k. Determination of sale price which would give a desired profit for break-even
- l. Determination of the cash requirements as a desired volume of output, with the help of cash break-even charts
- m. Break-even analysis emphasizes the importance of capacity utilization for achieving economy.
- n. During severe recession, the comparative effects of a shutdown or continued operation at a loss are indicated.
- o. The effect on total cost of a change in the fixed overhead is more clearly demonstrated through break-even charts.

### Limitations of Break-even Analysis

- a. That Costs are either fixed or variable and all costs are clearly segregated into their fixed and variable elements. This cannot possibly be done accurately and the difficulties and complications involved in such segregation make the break-even point inaccurate.
- b. That the behavior of both costs and revenue is not entirely related to changes in volume.
- c. That costs and revenue patterns are linear over levels of output being considered. In practice, this is not always so and the linear relationship is true only within a short run relevant range.
- d. That fixed costs remain constant and variable costs vary in proportion to the volume. Fixed costs are constant only within a limited range and are liable to change at varying levels of activity and also over a long period, particularly when additional plants and equipments are introduced.
- e. That sales mix is constant or only one product is manufactured. A combined analysis taking all the products of the mix does not reflect the correct position regarding individual products.
- f. That production and sales figures are identical or the change in opening and closing stocks of the finished product is not significant.
- g. That the units of production on the various product range are identical. Otherwise, it is difficult to find a homogeneous factor to represent volume.
- h. That the activities and productivity of the concern remain unchanged during the period of study.
- i. As output is continuously varied within a limited range, the contribution margin remains relatively constant. This is possible mainly where the output is more or less homogeneous as in the case of process industries.

### Margin of Safety

It is the sales point beyond the breakeven point. Margin of safety can be obtained by subtracting break even sales from Total sales. It is useful to determine financial soundness of business enterprise. If margin of safety is high, then the financial position of the enterprise is sound.

Margin of Safety = Total Sales – Break Even Sales → (1)

Total Sales = Break Even Sales + Margin of Safety Sales → (2)

→ Margin of safety can also be computed as follows:

Margin of Safety = Profit / P/V ratio → (3)

A relative measure to the margin of safety is its ratio to total sales.

→ Margin of safety ratio is the ratio of Margin of safety sales to Total sales.

Margin of safety ratio = [Margin of safety / Total sales] x 100 → (4)

→ Margin of safety ratio and Break even sales ratios are complements of each other.

→ If the sales amount, P/V ratio and M/S ratio are given, then profit can be computed as follows:

Profit = Total sales x P/V ratio x M/S ratio → (5)

Apart from the above formulae, various formulae that are used in the chapter to find out different results are as follows:

$$\text{Profit} = (\text{Sales} \times \text{P/V ratio}) - \text{Fixed Cost}$$

$$\text{Sales value to earn desired profit} = \left( \frac{\text{Fixed Cost} + \text{desired profit}}{\text{P/V ratio}} \right) \text{ and}$$

$$\text{Required units to earn desired profit} = \left( \frac{\text{Fixed Cost} + \text{desired profit}}{\text{Contribution per unit}} \right)$$

$$\text{Fixed cost} = (\text{Sales} \times \text{P/V ratio}) - \text{Profit}$$

$$\text{Total sales} = \text{Break even sales} + \text{Margin of safety sales}$$

$$\text{Break even sales} = \text{Total sales} - \text{Margin of safety sales}$$

$$\text{Margin of safety sales} = \text{Total sales} - \text{Break even sales}$$

$$\text{Fixed cost} = \text{Break even sales} \times \text{P/V ratio}$$

$$\text{Shut down sales} = \left( \frac{\text{Fixed Cost} - \text{Shut down costs}}{\text{P/V ratio}} \right)$$

$$\text{Shut down Units} = \left( \frac{\text{Fixed Cost} - \text{Shut down costs}}{\text{Contribution per unit}} \right)$$

The level at which profits are same or the level at which costs are same for two methods or two alternatives

$$\text{i.e., Indifference Point} = \left( \frac{\text{Difference in fixed costs}}{\text{Difference in variable costs per unit}} \right)$$

### Profit-volume chart

This is similar to a breakeven chart. In this chart the vertical axis represents profits and losses and the horizontal axis is drawn at zero profit or loss. In this chart each level of activity is taken into account and profits marked accordingly. The breakeven point is where this line intersects the horizontal axis. A profit-volume graph is given below:

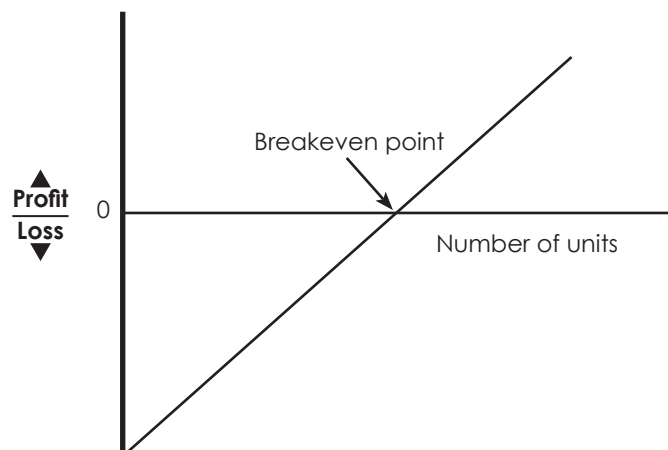

The main advantage of the profit-volume chart is its capability of exhibiting clearly the effect on profit and breakeven point of any changes in the variables.

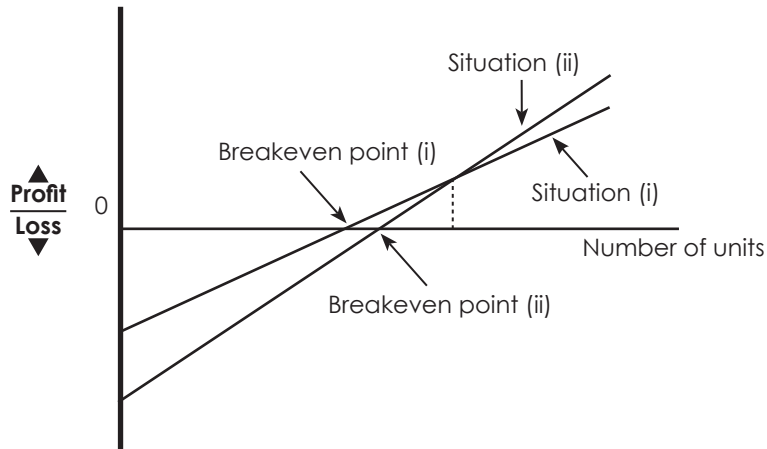

**Illustration 2**

ABC Ltd. incurs fixed costs of ₹ 3,00,000 per annum. It is a single product company with annual sales budgeted to be 70,000 units at a sales price of ₹ 300 per unit. Variable costs are ₹ 285 per unit.

The company is deliberating upon an increase in the selling price of the product to ₹ 350 per unit. This shall be required in order to improve the quality of the product. It is anticipated that despite increase in the selling price the sales volume shall remain unaffected. However, the fixed costs shall increase to ₹ 450,000 per annum and the variable costs to ₹ 330 per unit.

You are required to draw a profit volume graph, and determine the breakeven point. Also draw on the same graph a second profit volume graph and give your comments.



**Workings:**

The profit for sales of 70,000 units is ₹ 7,50,000

Particulars	(₹ 000)
Contribution 70,000 × (₹ 300 – ₹ 285)	1050
Fixed Costs	300
Profit	750

This point is joined to the loss at zero activity, ₹ 3,00,000 i.e., the fixed costs.

The profit for sales of 70,000 units is ₹ 9,50,000

Particulars	(₹ 000)
Contribution 70,000 × (₹ 300 – ₹ 330)	1400
Fixed Costs	450
Profit	950

This point is joined to the loss at zero activity, ₹ 4,50,000 i.e., the fixed costs.

**Comments:**

It is clear from the graph that there are larger profits available from option (ii). It also shows an increase in the break-even point from 20,000 units to 22,500 units. However, the increase of 2,500 units may not be considered large in view of the projected sales volume. It is worth-mentioning that for sales volumes above 30,000 units the profit achieved will be higher with option (ii). For sales volumes below 30,000 units option (i) will yield higher profits (or lower losses).



### Use of CVP Analysis in Decision Making

CVP analysis is used as an evaluation tool for managerial decisions. Therefore, let us discuss the decision making framework. In the framework of decision making the following steps are to be taken into consideration.

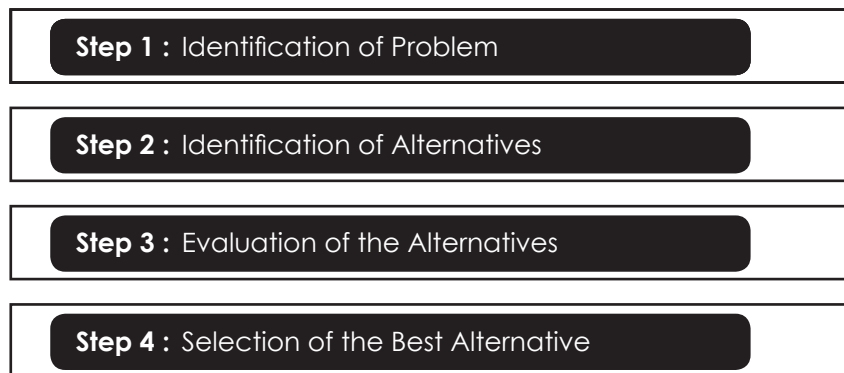

### Principles for Identification of Cost and Benefits for measurement

The cost and benefit of an alternative is identified for measurement if it satisfies the following principles:

**Controllability:** The costs and benefits which are controllable are considered for measurement for making decision.

**Relevance:** The costs which are controllable need to be relevant for decision making. Thus, a cost is relevant only if (i) it is a future cost and (ii) it differs under two alternatives under consideration.

### Principles for Estimation of Costs and Benefits

After identification of the costs and benefits, it is needed to be measured and estimated. The estimation is done by the two principles viz. (a) variability and (b) traceability.

### Short-term Decision making using concepts of CVP Analysis

Management uses marginal costing and CVP concepts for making various decisions. Generally, short-term decisions are related with temporary gaps between demand and supply for available resources. The areas of short term decision are classified into two broad categories:

- (i) *Decision related with excess supply, such as:*
  - (a) Processing of Special Order
  - (b) Determination of price for stimulating demand
  - (c) Local vs Export sale
  - (d) Determination of minimum price for price quotations
  - (e) Shut-down or continue decision etc.
- (ii) *Decision related with excess demand, such as:*
  - (a) Make or Buy/ In-house-processing vs Outsourcing
  - (b) Product mix decision under resource constraints (limiting factors)
  - (c) Sales mix decisions
  - (d) Sale or further processing etc.

**Illustration 3**

The sports material manufacturing company budgeted the following data for the coming year.

	Amount (₹)
Sales (1,00,000 units)	1,00,000
Variable cost	40,000
Fixed cost	50,000

Find out

- (a) P/V Ratio, B.E.P and Margin of Safety
- (b) Evaluate the effect of
  - (i) 20% increase in physical sales volume
  - (ii) 20% decrease in physical sales volume
  - (iii) 5% increase in variable costs
  - (iv) 5% decrease in variable costs
  - (v) 10% increase in fixed costs
  - (vi) 10% decrease in fixed costs
  - (vii) 10% decreases in selling price and 10% increase in sales volume
  - (viii) 10% increase in selling price and 10% decrease in sales volume
  - (ix) ₹ 5,000 variable cost decrease accompanied by ₹ 15,000 increase in fixed costs.

**Solution:**

- (a) P/V ratio, B.E.P and Margin of Safety

$$\begin{aligned}\text{Contribution} &= \text{Sales} - \text{Variable cost} \\ &= 1,00,000 - 40,000 \\ &= ₹ 60,000\end{aligned}$$

$$\begin{aligned}\text{P/V Ratio} &= (\text{Contribution} / \text{Sales}) \times 100 \\ &= (60,000 / 1,00,000) \times 100 \\ &= 60\%\end{aligned}$$

$$\begin{aligned}\text{B.E.P sales} &= \text{Fixed cost} / \text{PV ratio} \\ &= 50,000 / 60\% \\ &= ₹ 83,333\end{aligned}$$

$$\begin{aligned}\text{Margin of Safety} &= \text{Total sales} - \text{B.E.P sales} \\ &= 1,00,000 - 83,333 \\ &= ₹ 16,667\end{aligned}$$



(b)

Amount (₹)

	Contribution	P/V ratio	BE Sales	Margin of safety
(i) Increase in volume by 20%	1,20,000 – 48,000 = 72,000	(72,000 / 1,20,000) x 100 = 60%	(50,000 / 60%) = 83,333	1,20,000 – 83,333 = 36,667
(ii) Decrease in volume by 20%	80,000 – 32,000 = 48,000	(48,000 / 80,000) x 100 = 60%	(50,000 / 60%) = 83,333	80,000 – 83,333 = (3,333)
(iii) 5% increase in variable cost	1,00,000 – 42,000 = 58,000	(58,000 / 1,00,000) x 100 = 58%	(50,000 / 58%) = 86,207	1,00,000 – 86,207 = 13,793
(iv) 5% decrease in variable cost	1,00,000 – 38,000 = 62,000	(62,000 / 1,00,000) x 100 = 62%	(50,000 / 62%) = 80,645	1,00,000 – 80,645 = 19,355
(v) 10% increase in fixed cost	1,00,000 – 40,000 = 60,000	(60,000 / 1,00,000) x 100 = 60%	(55,000 / 60%) = 91,667	1,00,000 – 91,667 = 8,333
(vi) 10% decrease in fixed costs	1,00,000 – 40,000 = 60,000	(60,000 / 1,00,000) x 100 = 60%	(45,000 / 60%) = 75,000	1,00,000 – 75,000 = 25,000
(vii) 10% decreases in selling price and 10% increase in sales volume	99,000 – 44,000 = 55,000	(55,000 / 99,000) x 100 = 55.55%	(50,000 / 55.55%) = 90,009	99,000 – 90,009 = 8,991
(viii) 10% increase in selling price and 10% decrease in sales volume	99,000 – 36,000 = 63,000	(63,000 / 99,000) x 100 = 63.63%	(50,000 / 63.63%) = 78,579	99,000 – 78,579 = 20,421
(ix) ₹ 5,000 variable cost decrease accompanied by ₹ 15,000 increase in fixed costs.	1,00,000 – 35,000 = 65,000	(65,000/1,00,000) x 100 = 65%	(65,000 / 65%) = 1,00,000	1,00,000 – 1,00,000 = 0

**Illustration 4**

Two businesses AB Ltd and CD Ltd sell the same type of product in the same market. Their budgeted profits and loss accounts for the year ending 30th June, 2016 are as follows: Amount (₹)

	AB Ltd		CD Ltd	
Sales		1,50,000		1,50,000
Less: Variable costs	1,20,000		1,00,000	
Fixed Cost	15,000	1,35,000	35,000	1,35,000
Profit		15,000		15,000

You are required to calculate the B.E.P of each business and state which business is likely to earn greater profits in conditions.

- (a) Heavy demand for the product
- (b) Low demand for the product.



**Solution:**

**Statement Showing Computation of P/V ratio, BEP and Determination of Profitability in Different conditions:**

	Particulars	AB Ltd	CD Ltd
I.	Sales	1,50,000	1,50,000
II.	Variable cost	1,20,000	1,00,000
III.	Contribution	30,000	50,000
IV.	P/V ratio $\left[ \frac{(30,000/1,50,000) \times 100}{(50,000/1,50,000) \times 100} \right]$	20%	33 1/3%
V.	Fixed cost	15,000	35,000
VI.	Profit	15,000	15,000
VII.	Breakeven sales (V/IV)	75,000	1,05,000

From the above computation, it was found that the product produced by CD Ltd is more profitable in conditions of heavy demand because its P/V ratio is higher. On the other hand, in the condition of low demand, the product produced by AB Ltd is more profitable because its BEP is low.

**Illustration 5**

A factory is currently working to 40% capacity and produces 10,000 units. At 50% the selling price falls by 3%. At 90% capacity the selling price falls by 5% accompanied by similar fall in prices of raw material. Estimate the profit of the company at 50% and 90% capacity production.

The cost at present per unit is:

- Material ₹ 10
- Labour ₹ 3
- Overheads ₹ 5 (60% fixed)

The selling price per unit is ₹ 20/- per unit.

**Solution:**

**Statement Showing Computation of Profit at 50% and 90% Capacity as well as at Current Capacity:**

	Particulars	40%		50%		90%	
		Amount (₹)		Amount (₹)		Amount (₹)	
		Unit	Total	Unit	Total	Unit	Total
I.	Selling price	20.00	2,00,000	19.40	2,42,500	19.00	4,27,500
II.	Variable cost						
	Material	10.00	1,00,000	10.00	1,25,000	9.50	2,13,750
	Labour	3.00	30,000	3.00	37,500	3.00	67,500
	Variable OH	2.00	20,000	2.00	25,000	2.00	45,000
		15.00	1,50,000	15.00	1,87,500	14.50	3,26,250
III.	Contribution	5.00	50,000	4.40	55,000	4.50	1,01,250
IV.	Fixed cost	3.00	30,000		30,000		30,000
V.	Profit		20,000		25,000		71,250
VI.	B.E. sales $\left( \frac{F \times S}{C} \right)$		1,20,000		1,32,273		1,26,667





**Illustration 6**

The sales turnover and profit during two periods were as follows:

Amount (₹)		
Period	Sales	Profit
1	2,00,000	20,000
2	3,00,000	40,000

What would be probable trading results with sales of ₹1,80,000? What amount of sales will yield a profit of ₹ 50,000?

**Solution:**

$$\begin{aligned}
 \text{P/V ratio} &= (\text{Change in profit} / \text{Change in sales}) \times 100 \\
 &= (20,000 / 1,00,000) \times 100 = 20\% \\
 \text{Fixed cost} &= (\text{Sales} \times \text{P/V ratio}) - \text{Profit} \\
 &= (2,00,000 \times 0.2) - 20,000 = ₹ 20,000 \\
 \text{Sales required to earn desired profit} &= \frac{\text{Fixed cost} + \text{desired profit}}{\text{P/V ratio}} \\
 &= (20,000 + 50,000) / 20\% = ₹ 3,50,000
 \end{aligned}$$

**Illustration 7**

The following results of a company for the last two years are as follows:

Amount (₹)		
Year	Sales	Profit
2014	1,50,000	20,000
2015	1,70,000	25,000

You are required to calculate:

- (i) P/V Ratio
- (ii) B.E.P
- (iii) The sales required to earn a profit of ₹ 40,000
- (iv) Profit when sales are ₹ 2,50,000
- (v) Margin of safety at a profit of ₹ 50,000 and
- (vi) Variable costs of the two periods.

**Solution:**

$$\begin{aligned}
 \text{(i) P/V ratio} &= (\text{Change in profit} / \text{Change in sales}) \times 100 \\
 &= (5,000 / 20,000) \times 100 = 25\% \\
 \text{Fixed cost} &= (\text{Sales} \times \text{P/V ratio}) - \text{Profit} = (1,50,000 \times 25\%) - 20,000 = ₹ 17,500 \\
 \text{(ii) Break even sales} &= \text{Fixed cost} / \text{PV ratio} = 17,500 / 25\% = ₹ 70,000 \\
 \text{(iii) Sales required to earn a profit of ₹ 40,000} &= \frac{\text{Fixed cost} + \text{desired profit}}{\text{P/V ratio}} \\
 &= (17,500 + 40,000) / 25\% = ₹ 2,30,000
 \end{aligned}$$



- (iv) Profit at sales ₹ 2,50,000 = (Sales x P/V ratio) – Fixed cost  
 = (2,50,000 x 25%) – 17,500 = ₹ 45,000
- (v) Margin of safety at profit of ₹ 50,000 = Profit / PV ratio  
 = 50,000 / 25% = ₹ 2,00,000
- (vi) Variable cost for 2011 = 1,50,000 x 75% = ₹ 1,12,500  
 Variable cost for 2012 = 1,70,000 x 75% = ₹ 1,27,500

**Illustration 8**

SV Ltd a multi product company furnishes you the following data relating to the year 2015:

Amount (₹)

	First Half of the year	Second Half of the year
Sales	45,000	50,000
Total cost	40,000	43,000

Assuming that there is no change in prices and variable cost and that the fixed expenses are incurred equally in the two half year period, calculate for the year, 2015

- (i) The P/V Ratio,      (iii) Break-even sales  
 (ii) Fixed Expenses      (iv) Percentage of Margin of safety.

**Solution:**

- (i) P/V ratio = [(7,000 – 5,000) / (50,000 – 45,000)] x 100 = 40%
- (ii) Fixed expenses for first half year : = (Sales x PV ratio) – Profit  
 = (45,000 x 0.4) – 5,000 = ₹ 13,000  
 Fixed expenses for the year = 13,000 + 13,000 = ₹ 26,000
- (iii) Break even sales = 26,000 / 40% = ₹ 65,000
- (iv) Margin of safety = (50,000 + 45,000) – 65,000 = ₹ 30,000  
 Margin of safety ratio = [30,000 / (50,000 + 45,000)] x 100 = 31.58%

**Illustration 9**

S Ltd. furnishes you the following information relating to the half year ended 30th June, 2015.

Fixed expenses	₹ 45,000
Sales value	₹1,50,000
Profit	₹ 30,000

During the second half the year the company has projected a loss of ₹10,000.

Calculate:

- The B.E.P and M/S for six months ending 30th June, 2015.
- Expected sales volume for the second half of the year assuming that the P/V Ratio and Fixed expenses remain constant in the second half year also.
- The B.E.P and M/S for the whole year for 2015.



**Solution:**

(1) P/V ratio = (Fixed cost + Profit) / Sales

P/V ratio : = [(45,000 + 30,000) / 1,50,000] x 100 = 50%

BE sales for I half year = 45,000 / 50% = ₹ 90,000

Margin of safety for I half year = 1,50,000 – 90,000 = ₹ 60,000

For II half year:

(2) P/V ratio = (Fixed cost + Profit) / Sales

0.5 = [45,000 + (-) 10,000] / Sales

0.5 sales = 35,000

⇒ Sales = ₹ 70,000

(3) BE sales for 2015 = (45,000 + 45,000) x 50% = 1,80,000

Margin of safety for 2015 = (1,50,000 + 70,000) – 1,80,000 = ₹ 40,000

**Illustration 10**

The following is the statement of a Radical Co. for the month of June.

Amount (₹)

	Products		Total
	L	M	
Sales	60,000	60,000	1,20,000
Variable costs	42,000	30,000	72,000
Contribution	18,000	30,000	48,000
Fixed cost			36,000
Net Income			12,000

You are required to compute the P/V ratio for each product and then compute the P/V Ratio, Break-even Point and net profit for the following assumption.

(i) Sales revenue divided 60% to Product L & 40% to Product M.

(ii) Sales revenue divided 40% to Product L & 60% to Product M.

Also calculate the profit estimated on sales upto ₹ 1,80,000/- p.m. for each of the sales mix provided above.

**Solution:**

**Computation of P/V ratio**

Particulars	L	M	Total
P/V ratio = (C/S) x 100	30%	50%	40%

**(i) For Assumption I:****Statement showing computation of P/V ratio, Break even point and profit** Amount (₹)

Sr. No.	Particulars	L	M	Total
I.	Sales	72,000	48,000	1,20,000
II.	Variable cost (L - 70%); (M - 50%)	50,400	24,000	74,400
III.	Contribution (L - 30%); (M - 50%)	21,600	24,000	45,600
IV.	Fixed cost			36,000
V.	Profit			9,600
	P/V ratio $(45,600 \times 1,20,000) / 100 = 38\%$	30%	50%	38%
	Break even sales = $36,000 / 38\% = ₹94,737$			

**(ii) For Assumption II:****Statement showing computation of P/V ratio, Break even point and profit** Amount (₹)

Sr. No.	Particulars	L	M	Total
I.	Sales	48,000	72,000	1,20,000
II.	Variable cost (L - 70%); (M - 50%)	33,600	36,000	69,600
III.	Contribution (L - 30%); (M - 50%)	14,400	36,000	50,400
IV.	Fixed cost			36,000
V.	Profit			14,400
	P/V ratio $(50,400 \times 1,20,000) / 100 = 42\%$	30%	50%	42%
	Break even sales = $36,000 / 42\% = ₹85,714$			

**Illustration 11**

Accelerate Co. Ltd., manufactures and sells four types of products under the brand names of A, B, C and D. The sales Mix in value comprises  $33\frac{1}{3}\%$ ,  $41\frac{2}{3}\%$ ,  $16\frac{2}{3}\%$  and  $8\frac{1}{3}\%$  of products A, B, C & D respectively.

The total budgeted sales (100% are ₹60,000 p.m). Operating costs are:

Variable Costs:

Product A 60% of selling price

Product B 68% of selling price

Product C 80% of selling price

Product D 40% of selling price

Fixed Costs: ₹ 14,700 p.m.

- (a) Calculate the break - even - point for the products on overall basis and  
 (b) Also calculate break-even-point, if the sales mix is changed as follows the total sales per month remaining the same. Mix: A - 25% : B - 40% : C - 30% : D - 5%.

**Solution:**

	Particulars	A(₹)	B(₹)	C(₹)	D(₹)	Total(₹)
I.	Sales	20,000	25,000	10,000	5,000	60,000
II.	Variable cost	12,000	17,000	8,000	2,000	39,000
III.	Contribution	8,000	8,000	2,000	3,000	21,000
IV.	Fixed cost					14,700
V.	Profit					6,300
	P/V ratio = $(C/S) \times 100$	40%	32%	20%	60%	35%



(a) Break even sales

$$\text{Break even sales} = 14,700 / 35\% = ₹ 42,000$$

(b)

Amount (₹)

	Particulars	A	B	C	D	Total
I.	Sales	15,000	24,000	18,000	3,000	60,000
II.	Variable cost	9,000	16,320	14,400	1,200	40,920
III.	Contribution	6,000	7,680	3,600	1,800	19,080
IV.	Fixed cost					14,700
V.	Profit					4,380
	P/V ratio = (C/S) x 100	40%	32%	20%	60%	31.8 %

$$\text{Break even sales} = 14,700 / 31.8\% = ₹ 46,226$$

### Illustration 12

Present the following information to show to management:

- The marginal product cost and the contribution p.u.
- The total contribution and profits resulting from each of the following sales mix results.

Amount (₹)

Particulars	Product	Per unit
Direct Materials	A	10
Direct Materials	B	9
Direct wages	A	3
Direct wages	B	2

Fixed Expenses – ₹ 800

(Variable expenses are allotted to products at 100% Direct Wages)

Sales Price ----- A ₹ 20

Sales Price ----- B ₹ 15

- Sales Mixtures:
- 100 units of Product A and 200 of B.
  - 150 units of Product A and 150 of B.
  - 200 units of Product A and 100 of B.

**Solution:**

**(i) Statement of Marginal Product cost**

Amount (₹)

Sr. No.	Particulars	A	B
I.	Selling price	20.00	15.00
II.	Variable cost		
	Direct material	10.00	9.00
	Direct wages	3.00	2.00
	Variable OHs (100% of direct wages)	3.00	2.00
		16.00	13.00
III.	Contribution (I – II)	4.00	2.00



## (ii) Profit at Mix (a):

Amount (₹)

Sr. No.	Particulars	A	B	Total
I.	No. of units	100	200	
II.	'C' per unit	4	2	
III.	Total contribution (II x I)	400	400	800
IV.	Fixed cost			800
V.	Profit (III - IV)			Nil

## Profit at Mix (b):

Amount (₹)

Sr. No.	Particulars	A	B	Total
I.	No. of units	150	150	
II.	'C' per unit	4	2	
III.	Total contribution (II x I)	600	300	900
IV.	Fixed cost			800
V.	Profit (III - IV)			100

## Profit at Mix (c):

Amount (₹)

Sr. No.	Particulars	A	B	Total
I.	No. of units	200	100	
II.	'C' per unit	4	2	
III.	Total contribution (I x II)	800	200	1000
IV.	Fixed cost			800
V.	Profit (III - IV)			200

here 'C' means 'Contribution' .

**Illustration 13**

The following particulars are extracted from the records of a company:

		PER UNIT	
		PRODUCT A	PRODUCT B
Sales	(₹)	100	120
Consumption of material		2 Kg	3 Kg
Material cost	(₹)	10	15
Direct wages cost	(₹)	15	10
Direct expenses	(₹)	5	6
Machine hours used		3 Hrs	2 Hrs
<b>Overhead expenses:</b>			
Fixed	(₹)	5	10
Variable	(₹)	15	20

Direct wages per hour is ₹ 5

- (a) Comment on profitability of each product (both use the same raw material) when :
- 1) Total sales potential in units is limited;
  - 2) Total sales potential in value is limited;
  - 3) Raw material is in short supply;
  - 4) Production capacity (in terms of machine hours) is the limiting factor.
- (b) Assuming raw material as the key factor, availability of which is 10,000 Kgs. and each product cannot be sold more than 3,500 units find out the product mix which will yield the maximum profit.



**Illustration 14**

A company has a capacity of producing 1 lakh units of a certain product in a month. The sales department reports that the following schedule of sales prices is possible.

VOLUME OF PRODUCTION		SELLING PRICE PER UNIT
	%	₹
	60	0.90
	70	0.80
	80	0.75
	90	0.67
	100	0.61

The variable cost of manufacture between these levels is 15 paise per unit and fixed cost ₹ 40,000. Prepare a statement showing incremental revenue and differential cost at each stage. At which volume of production will the profit be maximum?

**Solution:**

**Statement showing computation of differential cost, incremental revenue and determination of capacity at which profit is maximum:**

Capacity %	Units	Sales	V. Cost @ (₹) 0.15	Fixed cost	Total Cost	Differential Cost	Incremental Revenue
60%	60,000	54,000	9,000	40,000	49,000	--	--
70%	70,000	56,000	10,500	40,000	50,500	1,500	2,000
80%	80,000	60,000	12,000	40,000	52,000	1,500	4,000
90%	90,000	60,300	13,500	40,000	53,500	1,500	300
100%	1,00,000	61,000	15,000	40,000	55,000	1,500	700

From the above computation, it was found that the incremental revenue is more than the differential cost up to 80% capacity, the profit is maximum at that capacity.

**Illustration 15**

A company is at present working at 90 per cent of its capacity and producing 13,500 units per annum. It operates a flexible budgetary control system. The following figures are obtained from its budget.

	90% Amount (₹)	100% Amount (₹)
Sales	15,00,000	16,00,000
Fixed expenses	3,00,500	3,00,600
Semi-fixed expenses	97,500	1,00,500
Variable expenses	1,45,000	1,49,500
Units made	13,500	15,000

Labour and material costs per unit are constant under present conditions. Profit margin is 10 per cent.

- You are required to determine the differential cost of producing 1,500 units by increasing capacity to 100%
- What would you recommend for an export price for these 1,500 units taking into account that overseas prices are much lower than indigenous prices?



**Solution:****Computation of material and labour cost**

Particulars	Amount (₹)	Amount (₹)
Sales at present		15,00,000
(-) Profit @ 10%		1,50,000
Total cost		13,50,000
(-) All costs other than material & labour		
Fixed expenses	3,00,500	5,43,000
Semi fixed expenses	97,500	
Variable expenses	1,45,000	
Material & Labour cost		8,07,000

**(a) Statement showing differential cost of 1500 units**

Particulars	Amount (₹)
Material & Labour (8,07,000 x 1500/13500)	89,667
Fixed expenses (3,00,600 – 3,00,500)	100
Semi fixed expenses (1,00,500 – 97,500)	3,000
Variable expenses (1,49,500 – 1,45,000)	4,500
Differential cost	97,267

(b) Differential cost per unit =  $97,267 / 1,500 = ₹ 64.84$

The minimum price for these 1,500 units should not be less than ₹ 64.84

**Illustration 16**

The operating statement of a company is as follows:		Amount (₹)
Sales (80,000 @ ₹15 each)		12,00,000
Costs:		
Variable:	(₹)	
Material	2,40,000	
Labour	3,20,000	
Overheads	<u>1,60,000</u>	
	7,20,000	
Fixed Cost	<u>3,20,000</u>	<u>10,40,000</u>
PROFIT		<u>1,60,000</u>

The capacity of the plant is 1 lakh units. A customer from U.S.A. is desirous of buying 20,000 units at a net price of ₹10 per unit. Advice the producer whether or not offer should be accepted. Will your advice be different, if the customer is local one.

**Solution:****Statement showing computation of profit before and after accepting the order**

				Amount (₹)
Sr. No.	Particulars	Present Position (Before accepting) 80,000	Order Value (20,000)	Total (After accepting) 1,00,000
I.	Sales	12,00,000	2,00,000	14,00,000
II.	Variable Cost			
	Material	2,40,000	60,000	3,00,000
	Labour	3,20,000	80,000	4,00,000
	Variable OH	1,60,000	40,000	2,00,000
		7,20,000	1,80,000	9,00,000
III.	Contribution (I - II)	4,80,000	20,000	5,00,000
IV.	Fixed cost	3,20,000	--	3,20,000
V.	Profit (III - IV)	1,60,000	20,000	1,80,000

As the profit is increased by ₹ 20,000 by accepting the order, it is advised to accept the same. If the order is from local one, it should not be accepted because it will adversely affect the present market.

**Illustration 17**

A company manufactures scooters and sells it at ₹3,000 each. An increase of 17% in cost of materials and of 20% of labour cost is anticipated. The increased cost in relation to the present sales price would cause at 25% decrease in the amount of the present gross profit per unit.

At present, material cost is 50%, wages 20% and overhead is 30% of cost of sales.

You are required to :

- Prepare a statement of profit and loss per unit at present and;
- Compute the new selling price to produce the same percentage of profit to cost of sales as before.

**Solution:**

Let X and Y be the cost and profit respectively.

$$X + Y = 3,000 \quad \rightarrow (1)$$

$$\text{Material} = X \times 50/100 = 0.5X$$

$$\text{Labour} = X \times 20/100 = 0.2X$$

$$\text{Overheads} = X \times 30/100 = 0.3X$$

**After increase of cost:**

$$\text{Material} = 0.5 X \times 117/100 = 0.585 X$$

$$\text{Labour} = 0.2X \times 120/100 = 0.240 X$$

$$\text{Overheads} = 0.300 X$$

$$= \underline{1.125 X}$$



$$\begin{aligned} \text{Profit} &= Y \times 75/100 = 0.75Y \\ \therefore \text{New Equation } 1.125X + 0.75Y &= 3,000 \rightarrow (2) \\ \text{Multiplying Eq. (1) by 0.75} \quad 0.75X + 0.75Y &= 2,250 \\ 0.375X &= 750 \\ X &= 750/0.375 = ₹ 2,000 \\ Y &= 3,000 - 2,000 = ₹ 1,000 \end{aligned}$$

**Statement of cost & profit per unit at present**

	Amount (₹)
Material = 2,000 x 50%	= 1,000
Labour = 2,000 x 20%	= 400
Overheads = 2,000 x 30%	= <u>600</u>
	= 2,000
(+) profit @ 50% of cost	= <u>1,000</u>
	= <u>3,000</u>

**Computation of new selling price to get same percentage of profit**

	Amount (₹)
Material = 1,000 x 117/100	= 1,170
Labour = 400 x 120/100	= 480
Overheads	= <u>600</u>
Cost	= 2,250
(+) Profit @ 50%	= <u>1,125</u>
New selling price	= <u>3,375</u>

**Illustration 18**

An umbrella manufacturer marks an average net profit of ₹ 2.50 per piece on a selling price of ₹14.30 by producing and selling 6,000 pieces or 60% of the capacity. His cost of sales is

	Amount (₹)
Direct material	3.50
Direct wages	1.25
Works overheads (50% fixed)	6.25
Sales overheads (25% variable)	0.80

During the current year, he intends to produce the same number but anticipates that fixed charges will go up by 10% which direct labour rate and material will increase by 8% and 6% respectively but he has no option of increasing the selling price. Under this situation, he obtains an offer for further 20% of the capacity. What minimum price you will recommend for acceptance to ensure the manufacturer an overall profit of ₹16,730.

**Solution:****Computation of profit at present after increase in cost**

	Particulars	Amount (₹)
I.	Selling price	14.30
II.	Variable cost	
	Material (3.5 x 106/100)	3.710
	Labour (1.25 x 108/100)	1.350
	Works overhead	3.125
	Sales overhead	0.200
	Total	8.385
III.	Contribution per unit (I-II)	5.915
IV.	Total contribution (6,000 x 5.915)	35,490
V.	Fixed cost	
	Works OH     3.125	24,585
	Sales OH     0.600     [3.725 x 6,000 = 22,350 x 110/100]	
VI.	Profit (iv - v)	10,905

**Computation of selling price of the order: (₹)**

Variable cost of order (2,000 x 8.385) = 16,770

(+) required profit (16,730 – 10,905) = 5,825

Sales required = 22,595

Selling price of order = 22,595/2,000 = 11.2975 (or) ₹ 11.30

**Illustration 19**

The Dynamic company has three divisions. Each of which makes a different product. The budgeted data for the coming year are as follows:

	Amount (₹)		
	A	B	C
Sales	<u>1,12,000</u>	<u>56,000</u>	<u>84,000</u>
Direct Material	14,000	7,000	14,000
Direct Labour	5,600	7,000	22,400
Direct Expenses	14,000	7,000	28,000
Fixed Cost	<u>28,000</u>	<u>14,000</u>	<u>28,000</u>
	61,600	35,000	92,400

The Management is considering to close down the division C'. There is no possibility of reducing fixed cost. Advise whether or not division C' should be closed down.

**Solution:****Statement showing computation of profit before closing down of division C**

Amount (₹)

Sr. No.	Particulars	A	B	C	Total
I.	Sales	1,12,000	56,000	84,000	2,52,000
II.	Variable cost				
	Direct Material	14,000	7,000	14,000	35,000
	Direct Labour	5,600	7,000	22,400	35,000
	Direct expenses	14,000	7,000	28,000	49,000
III.	Total Variable Cost	33,600	21,000	64,400	1,19,000
IV.	Contribution (i - iii)	78,400	35,000	19,600	1,33,000
V.	Fixed cost				70,000
VI.	Profit (iv - v)				63,000

**Statement showing computation of profit after closing C**

Amount (₹)

Sr. No.	Particulars	A	B	Total
I.	Sales	1,12,000	56,000	1,68,000
II.	Variable cost			
	Direct Material	14,000	7,000	21,000
	Direct Labour	5,600	7,000	12,600
	Direct expenses	14,000	7,000	21,000
III.	Total Variable Cost	33,600	21,000	54,600
IV.	Contribution (i - iii)	78,400	35,000	1,13,400
V.	Fixed cost			70,000
VI.	Profit (iv - v)			43,400

From the above computations, it was found that profit is decreased by (₹63,000 - ₹43,400) ₹ 19,600 by closing down division 'C', it should not be closed down. In other words, as long as if there is a contribution of ₹ 1, from division 'C', it should not be closed down.

**Illustration 20**

Mr. Young has ₹ 1,50,000 investment in a business. He wants a 15% profit on his money. From an analysis of recent cost figures he finds that his variable cost of operating is 60% of sales; his fixed costs are ₹75,000 per year. Show supporting computations for each answer.

- What sales volume must be obtained to break-even?
- What sales volume must be obtained to his 15% return on investment?
- Mr. Young estimates that even if he closed the doors of his business he would incur ₹25,000 expenses per year. At what sales would be better off by locking his sales up?

**Solution:**

$$\text{P/V ratio (V. cost ratio 60\%)} = 40\%$$

$$(a) \text{ Break even sales} = 75,000 / 40\% = ₹ 1,87,500$$

$$(b) \text{ Required sales to get desired income} = (75,000 + 22,500) / 40\% = ₹ 2,43,750 = ₹ 2,43,750$$

$$(c) \text{ Shut down sales} = \frac{\text{Fixed cost} - \text{shut down cost}}{\text{P/V Ratio}}$$

$$= (75,000 - 25,000) / 40\% = ₹ 1,25,000$$

**Illustration 21**

The manager of a Co. provides you with the following information:

	Amount (₹)
Sales	: 4,00,000
Costs: Variable (60% of sales)	
Fixed cost	: 80,000
Profit before tax	: 80,000
Income-tax (60%)	
Net profit	: 32,000

The company is thinking of expanding the plant. The increased fixed cost with plant expansion will be ₹40,000. It is estimated that the maximum production in new plant will be worth ₹2,40,000. The company also wants to earn additional income ₹3,200 on investment. On the basis of computations give your opinion on plant expansion.

**Solution:****Statement showing computation of profit before and after plant expansion**

Amount (₹)

Sr. No.	Particulars	Present (Before expansion)	Expansion value	Total (After expansion)
I.	Sales	4,00,000	2,40,000	6,40,000
II.	Variable cost (60%)	2,40,000	1,44,000	3,84,000
III.	Contribution (i - ii)	1,60,000	96,000	2,56,000
IV.	Fixed cost	80,000	40,000	1,20,000
V.	Profit before tax (iii - iv)	80,000	56,000	1,36,000
VI.	Profit after tax (V x 0.40)	32,000	22,400	54,400

From the above computations, it was found that the profit is increased by ₹ 22,400 by expanding the plant, which is much higher than the expected income of ₹ 3,200, one's opinion should be in favour of plant expansion.



## GLOSSARY

**Angle of Incidence:** Angle of Incidence is the angle between sales and total cost line. This angle is an indicator of profit earning capacity of the firm over the break-even point sales.

**Break-even Analysis:** Break-even Analysis is a method for examining the relationship between sales revenue, variable costs and fixed costs to determine the minimum value of production necessary to break-even.

**Break-even Chart:** Break-even Chart is the chart which shows the profitability or otherwise of a firm at various levels of activity. It indicates the point at which neither profit nor loss is made.

**Break-even Point:** Break-even Point is the volume of production or sales where total costs are equal to total revenue. In other words, Break-even Point is the level of activity at which there is neither profit nor loss.

**Contribution or Gross Margin:** Contribution or Gross Margin is the difference between sales value and the variable cost. In other words, Contribution or Gross Margin is defined as the amount recovered towards fixed cost and profit.

**Differential Cost:** Differential Cost is the change in the costs which results from the adoption of an alternative course of action.

**Marginal Cost:** Marginal Cost is the amount at any given volume of output by which aggregate costs are changed if the volume of output is increased or decreased by one unit. Marginal cost includes prime cost plus variable overhead.

**Marginal Costing:** Marginal Costing is the ascertainment of marginal costs and of the effect on profit of changes in volume or type of output by differentiating between fixed costs and variable costs. In other words, Marginal Costing is a costing system in which variable costs are charged to cost units and fixed costs of the period are written off in full against the total contribution.

**Margin of Safety:** Margin of Safety is represented by excess sales over and above the break-even point sales.

**Profit Volume Ratio (P/V Ratio) or Contribution Ratio:** Profit Volume Ratio (P/V Ratio) or Contribution Ratio is the ratio of Contribution to Sales.

$P/V \text{ Ratio} = (\text{Contribution}/\text{Sales}) \times 100$  or

$= [(\text{Sales} - \text{Variable cost})/\text{Sales}] \times 100$  or

$= (\text{Change in Contribution}/\text{Change in Sales}) \times 100$  or

$= (\text{Change in Profit}/\text{Change in Sales}) \times 100$



**Theoretical Questions:**

1. Discuss the break-even point with an illustration and a break-even chart.
2. Explain the points of difference between absorption costing and marginal costing.
3. Write short notes on:
  - (a) Margin of safety
  - (b) Angle of incidence
  - (c) Cash break-even point
  - (d) CVP Analysis

**MULTIPLE CHOICE QUESTIONS:**

1. The cost of a product under marginal costing system includes:
  - A. Prime cost plus variable overhead
  - B. Prime cost plus fixed overhead
  - C. Prime cost plus factory overhead
  - D. Only prime cost
  - E. None of the above
2. The difference between absorption costing and marginal costing is in regard to the treatment of :
  - A. Direct materials
  - B. Fixed overhead
  - C. Prime cost
  - D. Variable overhead
  - E. All of the above
3. Fixed costs are treated as:
  - A. Overhead costs
  - B. Prime costs
  - C. Period costs
  - D. Conversion costs
  - E. None of the above
4. When sales and production (in units) are same then profits under:
  - A. Marginal costing is lower than that of absorption costing
  - B. Marginal costing is higher than that of absorption costing
  - C. Marginal costing is equal to that of absorption costing
  - D. None of the above





5. When sales exceed production (in units) then profit under:
  - A. Marginal costing is higher than that of absorption costing
  - B. Marginal costing is equal to that of absorption costing
  - C. Marginal costing is lower than that of absorption costing
  - D. None of the above
6. Which of the following factors responsible for change in the break-even point?
  - A. Change in selling price
  - B. Change in variable cost
  - C. Change in fixed cost
  - D. All of the above
7. If sales are ₹ 90,000 and variable cost to sales is 75%, contribution is
  - A. ₹ 21,500
  - B. ₹ 22,500
  - C. ₹ 23,500
  - D. ₹ 67,500
8. Variable cost
  - A. Remains fixed in total
  - B. Remains fixed per unit
  - C. Varies per unit
  - D. Nor increase or decrease
9. If sales are ₹ 150,000 and variable cost are ₹ 50,000. Compute P/V ratio.
  - A. 66.66%
  - B. 100%
  - C. 133.33%
  - D. 65.66%
10. Marginal Costing technique follows the following basic of classification
  - A. Element wise
  - B. Function Wise
  - C. Behaviour wise
  - D. Identifiability wise
11. P/V ratio will increase if the
  - A. There is an decrease in fixed cost
  - B. There is an increase in fixed cost
  - C. There is a decrease in selling price per unit.
  - D. There is a decrease in variable cost per unit.



12. The technique of differential cost is adopted when
- A. To ascertain P/V ratio
  - B. To ascertain marginal cost
  - C. To ascertain cost per unit
  - D. To make choice between two or more alternative courses of action
13. Difference between the costs of two alternative is known as the
- A. Variable cost
  - B. Opportunity cost
  - C. Marginal cost
  - D. Differential cost
14. Contribution is ₹ 300,000 and sales is ₹ 1,500,000. Compute P/V ratio.
- A. 15%
  - B. 20%
  - C. 22%
  - D. 17.5%
15. Variable cost to sales ratio is 40%. Compute P/V ratio.
- A. 60%
  - B. 40%
  - C. 100%
  - D. None of the these
16. Fixed cost is 30,000 and P/V ratio is 20%. Compute breakeven point.
- A. ₹ 160,000
  - B. ₹ 150,000
  - C. ₹ 155,000
  - D. ₹ 145,000

[Ans: A, B, C, C, A, D, B, B, A, C, D, D, D, B, A, B]

**State whether the statements are True or False:**

1. Contribution = Sales × P/V ratio.
2. Margin of Safety = Profit / P/V ratio
3. P/ V ratio remains constant at all levels of activity.
4. Marginal Costing follows the behaviours wise classification of costs.
5. At breakeven point, contribution available is equal to total fixed cost.
6. Breakeven point = Profit / P/V ratio.
7. Marginal cost is aggregate of Prime Cost and Variable cost.



8. Variable cost remains fixed per unit.
9. Contribution margin is equal to Sales – Fixed cost.
10. Variable cost per unit is variable.

[Ans: T, T, T, T, T, F, F, T, F, F]

**Fill in the Blanks:**

1. Variable cost per unit is \_\_\_\_\_.
2. Marginal cost is the \_\_\_\_\_ of sales over contribution.
3. P/V ratio is the ratio of \_\_\_\_\_ to sales.
4. If variable cost to sales ratio is 60%, P/V ratio is \_\_\_\_\_.
5. \_\_\_\_\_ + Variable overhead = Marginal Cost.
6. When sales are ₹ 300,000 and variable cost is ₹ 180,000, P/V ratio will be \_\_\_\_\_.
7. Variable cost remains \_\_\_\_\_.
8. Margin of safety is \_\_\_\_\_.
9. Breakeven point is \_\_\_\_\_.
10. Contribution margin equals to \_\_\_\_\_.

[Ans: Fixed, Excess, Contribution, 40, Prime cost, 40%, fixed per unit, Actual sales-Sales at breakeven point, Total Fixed cost/ P/V ratio, Sales – Variable cost.]

**Match the following:**

	Column A		Column B
1.	Indifference point (in units)	A	Difference in Fixed Cost/ Difference in P/V ratio
2.	Breakeven point (in Value)	B	Fixed Cost / Contribution per unit
3.	Variable cost per unit	C	Total sales less BEP sales
4.	P/V ratio	D	Marginal Cost
5.	Prime cost + Variable overhead	E	Fixed Cost / P/V ratio
6.	Breakeven point (in Quantity)	F	Difference in Fixed Cost/ Difference in contribution per unit
7.	Indifference point (in Value)	G	Total contribution /Total Sales Value *100
8.	Shut Down point (in Quantity)	H	Avoidable Fixed Cost/ P/V Ratio
9.	Shut Down point (in value)	I	Fixed
10.	Margin of Safety	J	Avoidable Fixed Cost/ Contribution per unit

[Ans: F, E, I, G, D, B, A, J, H, C]



## 6.2 STANDARD COSTING & VARIANCE ANALYSIS

### Standard Cost

Standard Cost is defined as “*the predetermined cost that is calculated at the management's standards of efficient operations and the relevant necessary expenditure*”.

From this we understand that it is the cost calculated when all the people working in the organisation to their utmost, the expenditure incurred for producing the product can be taken as standard cost. The optimum efficiency can not at all time exists. Therefore, optimum efficiency is assumed and that is why standard cost is called assumed cost. Further, all the inputs of cost scientifically analysed using so many industrial engineering techniques such as work measurement, method study, time and motion study, merit rating, job evaluation and other scientific techniques, it can also be called as Scientific Cost.

### Standard Costs and Estimated Costs

The distinction between Standard Costs and Estimated Costs should be clearly understood. While both Standard Costs and Estimated Costs are predetermined costs, their objectives are different. The main differences between the two types of costs are:

1. Estimated Costs are intended to determine what the costs 'will' be. Standard Costs aim at what costs 'should' be.
2. Estimated Costs are based on average of past actual figures adjusted for anticipated changes in future. Anticipated wastes, spoilage and inefficiencies, all of which tend to increase costs are included in estimated costs. Standard Costs are planned costs determined on a scientific basis and they are based upon certain assumed conditions of efficiency and other factors.
3. In Estimated Costing Systems, stress is not so much on cost control, but costs are used for other purposes such as fixation of prices to be quoted in advance. Standard Costs serve as effective tools for cost control.

### Types of Standards

There are different types of standards stated as follows:

- (i) **Ideal Standard:** Ideal standard represents the level of performance attainable when prices for material and labour are most favourable, when the highest output is achieved with the best equipments and layout and when the maximum efficiency in utilising the resources results in maximum output with minimum cost. However, this type of standard is criticised due to the fact that such standard is practically unattainable.
- (ii) **Normal Standard:** Normal standard can be achieved under normal operating conditions. The normal activity is the number of standard hours which will produce at normal efficiency sufficiently good enough to meet the average sales demand over a period of time. This standard requires a degree of forecasting. Under this system the variances are deviations from normal efficiency, normal sales volume, or normal production volume.
- (iii) **Basic Standard:** Basic standard is applied only when it is likely to remain constant over a long period of time. A base year is chosen for the purpose of comparison. Since basic standard does not represent what should be attained in the present period, current standard should also be prepared when basic standard is used.
- (iv) **Current Standard:** Current standard reflects the management's anticipation of what actual costs will be for the current period. These are the costs that the firm will incur if anticipated prices are paid for the goods and services and the usage necessary to produce the planned output.



### Setting of Standard Costs

While setting production costs standards, the following preliminaries should be considered:

- a. Study of the technical and operational aspects of the concern, such as methods of manufacture and the processes involved, management of organisation and line of assignment of responsibilities, division of the organisation into cost centres, units of measurement of input and output, anticipation of wastes, rejections and losses, expected efficiency, and capacity likely to be utilized.
- b. Review of the existing costing system and the cost records and forms in use.
- c. The type of standard to be used, i.e. whether current, basic, or normal standard costs are to be set. The choice of a particular type of standard will depend upon two factors, viz. which type would be most effective for cost control in the organization, and whether the standards will be merged in the accounting system or kept outside the accounts as statistical data.
- d. Proper classification of the accounts so that variances may be determined in the manner desired.
- e. Fixation of responsibility for setting standards. As definite responsibility for variances from standards is ultimately to be laid on individuals or departments, it is but natural that all those individuals or departments should be associated with the setting of standards.

### Stock Valuation

The function of a Balance Sheet is to give a true and fair view of the state of affairs of a company on a particular date. A true and fair view also implies the consistent application of generally accepted principles. Stocks valued at standard costs are required to be adjusted at actual costs in the following circumstances:

- (a) As per Accounting Standards – 2, closing stock to be valued either at cost price or at net realisable value (NRV) whichever is less.
- (b) The standard costing system introduced is still in an experimental stage and the variances merely represent deviations from poorly set standards.
- (c) Occurrence of certain variances which are beyond the control of the management. (Unless the stocks are adjusted for uncontrollable factors, the values are not correctly started).

### Maintenance of Raw Material Stock at Standard Cost

In the single plan, the inventory in the stores ledger may be carried either at standard costs or at actual. Although both the methods are in use, the consensus is in favour of standard costs. The **advantages** of adopting standard costs for inventory valuation are as follows:

- a. Stores ledger may be maintained in quantities only and the standard price noted at the top in the ledger sheets. This economises the use of forms as well as reduces clerical costs as no columns for rates need be maintained.
- b. Pricing of materials requisitions is simplified as only one standard price for each item of material is required to be used.
- c. Price variance is promptly revealed at the time of purchase of material.

The **disadvantages** are:

- a. The stores ledger does not reveal the current prices.
- b. If the material stock is shown in the Balance Sheet at standard costs, the variances have the effect of distorting the profit or loss. Standard cost of the closing inventory is required to be adjusted to actual cost based on price variance to comply with the statutory requirement of the Companies Act, 2013.
- c. A revision of the standard necessitates revision of the cost of the inventory.



### **Difference between Standard Costing and Budgetary Control**

Like Budgetary Control, Standard Costing assume that costs are controllable along definite lines of supervision and responsibility and it aims at managerial control by comparison of actual performances with suitable predetermined yardsticks. The basic principles of cost control, viz., setting up of targets or standards, measurement of performance, comparison of actual with the targets and analysis and reporting of variances are common to both standard costing and budgetary control systems. Both techniques are of importance in their respective fields are complementary to each other. Thus, conceptually there is not much of a difference between standard costs and budgeted and the terms budgeted performance and standard performance mean, for many concerns one and the same thing.

Budgets are usually based on past costs adjusted for anticipated future changes but standard costs are of help in the preparation of production costs budgets. In fact, standards are often indispensable in the establishment of budgets. On the other hand, while setting standard overhead rates of standard costing purposes, the budgets framed for the overhead costs may be made use of with modifications, if necessary. Thus, standard costs and budgets are interrelated but not inter-dependent.

Despite the similarity in the basic principles of Standard Costing and Budgetary Control, the two systems vary in scope and in the matter of detailed techniques. The difference may be summarized as follows:

1. A system of Budgetary Control may be operated even if no Standard Costing system is in use in the concern.
2. While standard is an unit concept, budget is a total concept.
3. Budgets are the ceilings or limits of expenses above which the actual expenditure should not normally rise; if it does, the planned profits will be reduced. Standards are minimum targets to be attained by actual performance at specified efficiency.
4. Budgets are complete in as much as they are framed for all the activities and functions of a concern such as production, purchase, selling and distribution, research and development, capital utilisation, etc. Standard Costing relates mainly to the function of production and the related manufacturing costs.
5. A more searching analysis of the variances from standards is necessary than in the case of variations from the budget.
6. Budgets are indices, adherence to which keeps a business out of difficulties. Standards are pointers to further possible improvements.

### **Advantages of Standard Costing**

The advantages derived from a system of standard costing are tabulated below:

1. Standard Costing system establishes yard-sticks against which the efficiency of actual performances is measured.
2. The standards provide incentive and motivation to work with greater effort and vigilance for achieving the standard. This increase efficiency and productivity all round.
3. At the very stage of setting the standards, simplification and standardisation of products, methods, and operations are effected and waste of time and materials is eliminated. This assists in managerial planning for efficient operation and benefits all the divisions of the concern.
4. Costing procedure is simplified. There is a reduction in paper work in accounting and less number of forms and records are required.



5. Cost are available with promptitude for various purposes like fixation of selling prices, pricing of inter-departmental transfers, ascertaining the value of costing stocks of work-in-progress and finished stock and determining idle capacity.
6. Standard Costing is an exercise in planning - it can be very easily fitted into and used for budgetary planning.
7. Standard Costing system facilities delegation of authority and fixation of responsibility for each department or individual. This also tones up the general organisation of the concern.
8. Variance analysis and reporting is based on the principles of management by exception. The top management may not be interested in details of actual performance but only in the variances form the standards, so that corrective measures may be taken in time.
9. When constantly reviewed, the standards provide means for achieving cost reduction.
10. Standard costs assist in performance analysis by providing ready means for preparation of information.
11. Production and pricing policies may be formulated in advance before production starts. This helps in prompt decision-making.
12. Standard costing facilitates the integration of accounts so that reconciliation between cost accounts and financial accounts may be eliminated.
13. Standard Costing optimizes the use of plant capacities, current assets and working capital.

#### **Limitations of standard costing**

1. Establishment of standard costs is difficult in practice.
2. In course of time, sometimes even in a short period the standards become rigid.
3. Inaccurate, unreliable and out of date standards do more harm than benefit.
4. Sometimes, standards create adverse psychological effects. If the standard is set at high level, its non achievement would result in frustration and build-up of resistance.
5. Due to the play of random factors, variances cannot sometimes be properly explained, and it is difficult to distinguish between controllable and non-controllable expenses.
6. Standard costing may not sometimes be suitable for some small concerns. Where production cannot be carefully scheduled, frequent changes in production conditions result in variances. Detailed analysis of all of which would be meaningless, superfluous and costly.
7. Standard costing may not, sometimes, be suitable and costly in the case of industries dealing with non-standardized products and for repair jobs which keep on changing in accordance with customer's specifications.
8. Lack of interest in standard costing on the part of the management makes the system practically ineffective. This limitation, of course, applies equally in the case of any other system which the management does not accept wholeheartedly.

#### **Process of Standard Costing**

There are different processes of standard costing as enumerated below:

- (i) Setting of standards
- (ii) Determination of actual costs



- (iii) Comparison of standard cost with the actual costs
- (iv) Finding out the reasons for variances
- (v) Taking corrective action and disposal of variances

**Types of Variances**

Following are the types of variances:

- (i) Controllable and Uncontrollable variance
- (ii) Favourable and Adverse Variance

*Controllable variances* are those which can be controlled by the departmental heads whereas *Uncontrollable variances* are those which are beyond their control. However, controllability is a subjective matter and varies according to situations. If the Uncontrollable variances are of significant nature and persistent, the standard may need revision.

*Favourable variances* are those which are profitable for the company and *Adverse variances* are those which cause loss to the company. While computing cost variances favourable variances means actual cost is less than standard cost. On the contrary, adverse variances means actual cost exceeding standard cost. However, *the situation will be reverse for Sales variance*. Favourable variance means actual sales are more than budgeted. On the contrary Adverse variance means actual sales are less than budgeted. In short favourable variance is written as 'F' and adverse variance as 'A'.

**Classification of variances (Material and Labour only)**

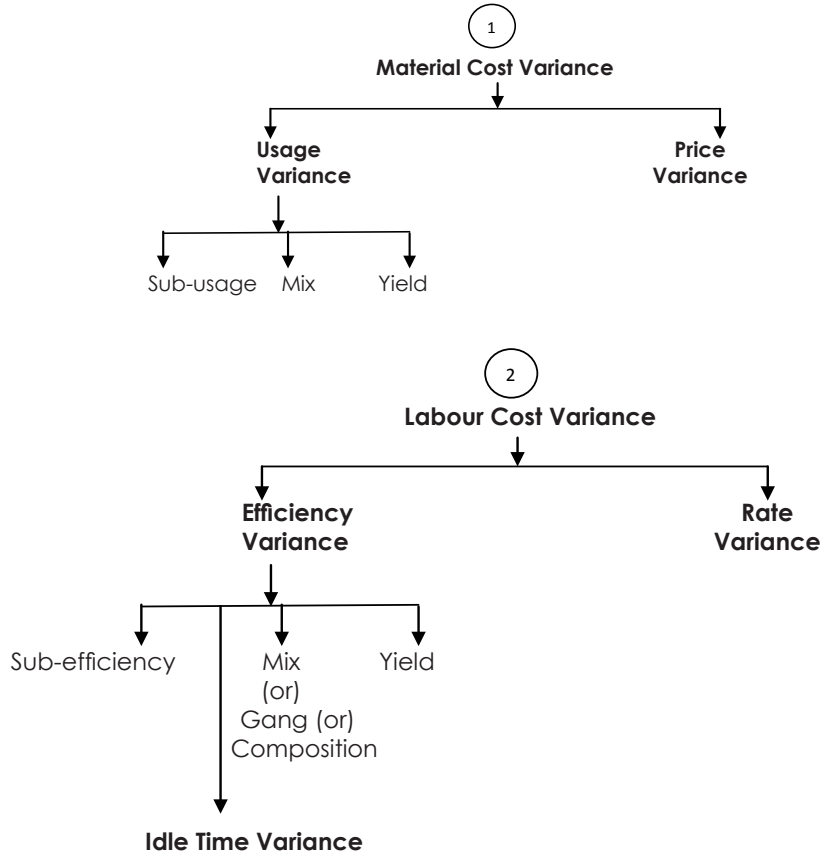





**Direct Materials Cost Variance:** Direct materials cost variance is the difference between the actual direct material cost incurred and the standard direct material cost specified for the production achieved.

- 1. Direct Materials Price Variance:** The difference between the actual and standard price per unit of the material applied to the actual quantity of material purchased or used.

$$\begin{aligned} \text{Direct materials price variance} &= (\text{Standard Price} \textit{ minus} \textit{ Actual Price}) \times \text{Actual Quantity, or} \\ &= (\text{SP}-\text{AP}) \text{ AQ} \\ &= (\text{Standard Price} \times \text{Actual Quantity}) \textit{ minus} (\text{Actual Price} \times \text{Actual Quantity}) \\ &= (\text{AQSP}-\text{AQAP}) \end{aligned}$$

#### Causes of Material Price Variance

- a. Change in basic purchase price of material
- b. Change in quantity of purchase or uneconomical size of purchase order
- c. Rush order to meet shortage of supply, or purchase in less or more favourable market
- d. Failure to take advantage of off-season price, or failure to purchase when price is cheaper
- e. Failure to obtain (or availability of) cash and trade discounts or change in the discount rates
- f. Weak purchase organisation
- g. Payment of excess or less freight
- h. Transit losses and discrepancies, if purchase price is inflated to include the loss
- i. Change in quality or specification of material purchased
- j. Use of substitute material having a higher or lower unit price
- k. Change in materials purchase, upkeep, and store-keeping cost. (This is applicable only when such changes are allocated to direct material costs on a predetermined or standard cost basis.)
- l. Change in the pattern or amounts of taxes and duties

- 2. Direct Materials Usage Variance:** The difference between the actual quantity used and the amount which should have been used, valued at standard price.

$$\begin{aligned} \text{Direct materials usage variance} &= (\text{Standard Quantity for actual output} \times \text{Standard Price}) \textit{ minus} \\ &(\text{Standard Price} \times \text{Actual Quantity}) \\ &= \text{SQSP}-\text{AQSP} \textit{ or} \\ &= \text{Standard Price} \times (\text{Standard Quantity for actual output} \textit{ minus} \text{Actual Quantity}) \\ &= \text{SP} (\text{SQ}-\text{AQ}) \end{aligned}$$

#### Causes of Materials Usage Variance

- a. Variation in usage of materials due to inefficient or careless use, or economic use of materials.
- b. Change in specification or design of product
- c. Inefficient and inadequate inspection of raw materials
- d. Purchase of inferior materials or change in quality of materials
- e. Rigid technical specifications and strict inspection leading to more rejections which require more materials for rectification
- f. Inefficiency in production resulting in wastages
- g. Use of substitute materials



- h. Theft or pilferage of materials
- i. Inefficient labour force leading to excessive utilisation of materials
- j. Defective machines, tools, and equipments, and bad or improper maintenance leading to breakdowns and more usage of materials
- k. Yield from materials in excess of or less than that provided as the standard yield
- l. Faulty materials processing. Timber, for example, if not properly seasoned may be wasted while being used in subsequent processes
- m. Accounting errors, e.g. when materials returned from shop or transferred from one job to another are not properly accounted for
- n. Inaccurate standards
- o. Change in composition of a mixture of materials for a specified output

**(i) Direct Materials Mix Variance:** One of the reasons for materials usage variance is the change in the composition of the materials mix. The difference between the actual quantity of material used and the standard proportion, priced at standard price.

$$\begin{aligned}\text{Mix variance} &= (\text{Revised Standard Quantity} \textit{ minus} \textit{ Actual Quantity}) \times \text{Standard Price.} \\ &= \text{RSQSP} - \text{AQSP}\end{aligned}$$

**(ii) Direct Materials Yield Variance:** Yield variance is the difference between the standard cost of production achieved and the actual total quantity of materials used, multiplied by the standard weighted average price per unit.

$$\text{Material yield variance} = (\text{Standard Yield for Actual Mix} \textit{ minus} \textit{ Actual Yield}) \times \text{Standard Yield Price}$$

(Standard yield price is obtained by dividing the total cost of the standard units by the total cost of the standard mixture by the total quantity (number of physical units).

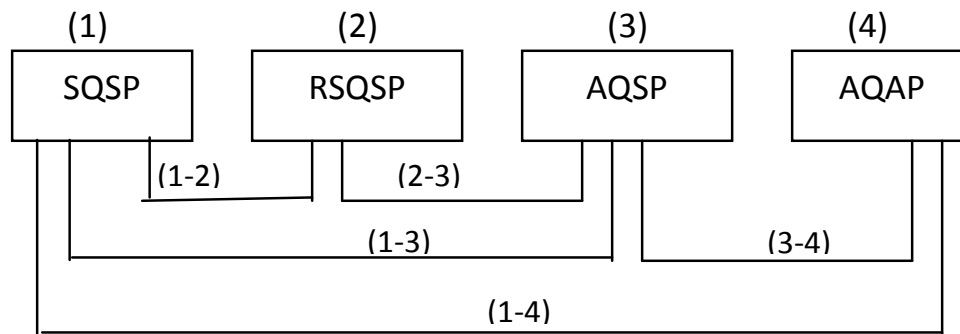

Where

SQ = Standard Quantity for Actual Production or Output

SP = Standard Price

AQ = Actual Quantity of Materials Consumed

AP = Actual Price

RSQ = Revised Standard Quantity

1. SQSP = Standard Cost of Standard Material

2. RSQSP = Revised Standard Cost of Standard Material

3. AQSP = Standard cost of Actual Material



4. AQAP = Actual Cost of Actual Material
  - (a) Material Sub-Usage or Yield Variance = 1-2
  - (b) Material Mix Variance = 2-3
  - (c) Material Usage Variance = 1-3
  - (d) Material Price Variance = 3-4
  - (e) Material Cost Variance = 1-4

**II. Direct Labour Cost Variance:** Direct Labour Cost Variance (also termed Direct Wage Variance) is the difference between the actual direct wages incurred and the standard direct wages specified for the activity achieved.

**1. Direct Labour Rate Variance (Wage Rate Variance):** The difference between the actual and standard wage rate per hour applied to the total hours worked.

$$\begin{aligned} \text{Wages rate variance} &= (\text{Standard Rate} \textit{ minus} \textit{ Actual Rate}) \times \text{Actual Hours} \\ &= (\text{SR}-\text{AR}) \times \text{AH} \\ &= \text{SRAH}-\text{ARAH} \end{aligned}$$

#### Causes of Direct Labour Rate Variances

- a. Change in basic wage structure or change in piece-work rate. These will give rise to a variance till such time the standards are not revised
- b. Employment of workers of grades and rates of pay different from those specified, due to shortage of labour of the proper category, or through mistake, or due to retention of surplus labour
- c. Payment of guaranteed wages to workers who are unable to earn their normal wages if such guaranteed wages form part of direct labour cost
- d. Use of a different method of payment, e.g. payment at day-rates while standards are based on piece-work method of remuneration.
- e. Higher or lower rates paid to casual and temporary workers employed to meet seasonal demands, or urgent or special work
- f. New workers not being allowed full normal wage rates
- g. Overtime and night shift work in excess of or less than the standard, or where no provision has been made in the standard. This will be applicable only if overtime and shift differential payments form part of the direct labour cost.
- h. The composition of a gang as regards the skill and rates of wages being different from that laid down in the standard

**2. Direct Labour Efficiency Variance (also termed Labour Time Variance):** The difference between the standard hours which should have been worked and the hours actually worked, valued at the standard wage rate.

$$\begin{aligned} \text{Direct Labour Efficiency Variance} &= (\text{Standard Hours for Actual Production} \textit{ minus} \textit{ Actual Hours}) \times \text{Standard Rate} \\ &= (\text{SH}-\text{AH}) \times \text{SR} \\ &= \text{SRSH}-\text{SRAH} \end{aligned}$$

#### Causes for Labour Efficiency Variance

- a. Lack of proper supervision or strict supervision than specified
- b. Poor working conditions



- c. Delays due to waiting for materials, tools, instructions, etc. if not treated as idle time
- d. Defective machines, tools and other equipments
- e. Machine break-down, if not booked to idle time
- f. Work on new machines requiring less time than provided for, till such time standard is not revised
- g. Basic inefficiency of workers due to low morale, insufficient training, faulty instructions, incorrect scheduling of jobs, etc.
- h. Use of non-standard material requiring more or less operation time
- i. Carrying out operations not provided for a booking them as direct wages
- j. Incorrect standards
- k. Wrong selection of workers, i.e., not employing the right type of man for doing a job
- l. Increase in labour turnover
- m. Incorrect recording of performances, i.e., time or output

**i. Direct Labour Composition or Mix or Gang Variance:** This is a sub-variance of labour efficiency variance. This variance arises due to change in the composition of a standard gang, or, combination of labour force.

$$\text{Mix or Gang or Composition Variance} = (\text{Actual Hours at Standard Rate of Standard Gang}) \text{ minus } (\text{Actual Hours at Standard Rate of Actual Gang})$$

**ii. Direct Labour Yield Variance:** Just as material yield variance is calculated, similarly labour yield variance can also be known. It is the variation in labour cost on account of increase or decrease in yield or output as compared to the relative standard. The formula is –

$$\text{Direct Labour Yield Variance} = \text{Standard Cost Per Unit} \times \left[ \frac{\text{Standard Output for Actual Mix}}{\text{Actual Output}} \right]$$

**3. Idle time variance:** This variance which forms a portion of wages efficiency variance, is represented by the standard cost of the actual hours for which the workers remain idle due to abnormal circumstances.

$$\text{Idle time variance} = (\text{Standard rate} \times \text{Actual hours paid for}) \text{ minus } (\text{Standard rate} \times \text{Actual hours worked}) \text{ or}$$

$$= \text{Standard Rate} \times \text{Idle Hours}$$

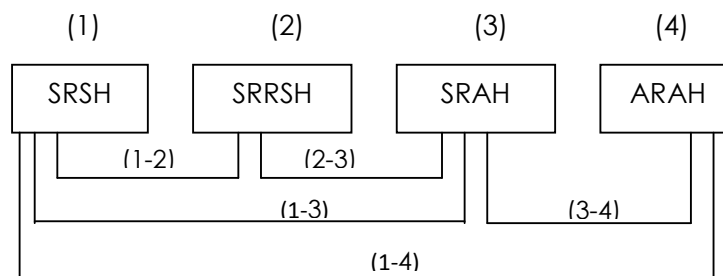

SR = Standard Rate of Labour Per Hour

SH = Standard Hours for Actual Production or Output

RSH = Revised Standard Hours



AH = Actual Hours

AR = Actual Rate of Labour per Hour

1. SRSH = Standard Cost of Standard Labour
2. SRRSH = Revised Standard Cost of Labour
3. SRAH = Standard Cost of Actual Labour
4. ARAH = Actual Cost of Labour
  - a. Labour Sub-Efficiency or Yield Variance = 1-2
  - b. Labour Mix or Gang or Composition Variance = 2-3
  - c. Labour Efficiency Variance = 1-3
  - d. Labour Rate Variance = 3-4
  - e. Labour Cost Variance = 1-4

Idle Time Variance = Idle Time Hours x Standard Rate per Hour.

It is to be noted that this is the part and parcel of efficiency ratio and always it is adverse.

### Illustration 1

Product A required 10 kg of material at a rate of ₹4 per kg. The actual consumption of material for the manufacturing product A comes to 12 kg of material at the rate of ₹4.50 per kg.

- Calculate:
- (a) Material Cost Variance
  - (b) Material Usage Variance
  - (c) Material Price Variance.

### Solution:

#### Computation of Required Values

- Let
- (1) SQSP = Standard Cost of Standard Material
  - (2) AQSP = Standard Cost of Actual Material
  - (3) AQAP = Actual Cost of Material

Given Values:

SQ = Standard Quantity of Material = 10 kg

AQ = Actual Quantity of Material = 12 kg

SP = Standard Price = ₹ 4 per kg

AP = Actual Price = ₹ 4.50 per kg.

$$(1) \text{ SQSP} = (10 \times 4) = ₹ 40$$

$$(2) \text{ AQSP} = (12 \times 4) = ₹ 48$$

$$(3) \text{ AQAP} = (12 \times 4.50) = ₹ 54$$

**Computation of Required Material Variances**

- a. Material Usage Variance = (1) – (2) = 40-48 = ₹8 (A)  
 b. Material Price Variance = (2) – (3) = 48-54 = ₹6 (A)  
 c. Material Cost Variance = (1) – (3) = 40-54 = ₹14 (A)

**Illustration 2**

The standard quantity and standard price of raw material required for one unit of product A are given as follows

	Quantity (kg.)	S.P. (₹)
Material X	2	3
Material Y	4	2

The actual production and relevant data are as follows:

Material X 1,100 kgs. @ ₹ 3,410

Material Y 1,800 kgs. @ ₹ 3,960

Calculate Variances. Actual production was 500 units.

**Solution:****Analysis of Given Data**

Amount (₹)

Material	Standard Data			Actual Data		
	Quantity (Kg.)	Price	Value	Quantity (Kg.)	Price	Value
A	1000 (500 x 2)	3.00	3,000	1,100	3.10	3,410
B	2000 (500 x 4)	2.00	4,000	1,800	2.20	3,960
	3000		7,000	2,900		7,370

Amount (₹)

Material	SQSP	RSQSP	AQSP	AQAP
X		966.67 x 3 = 2,900	1,100 x 3	
Y		1933.33 x 2 = 3,867	1,800 x 2	
Total	7,000	6,767	6,900	7,370

Where **(1) SQSP** = Standard Cost of Standard Material = ₹ 7,000

**(2) RSQSP** = Revised Standard Cost of Material = ₹ 6,767

**(3) AQSP** = Standard Cost of Actual Material = ₹ 6,900

**(4) AQAP** = Actual Cost of Material = ₹ 7,370



### Computation of Variances

- (a) Material Sub-usage variance = (1) – (2) = 7,000 – 6,767 = ₹ 233 (F)  
 (b) Material Mix variance = (2) – (3) = 6,767 – 6,900 = ₹ 133 (A)  
 (c) Material Usage variance = (1) – (3) = 7,000 – 6,900 = ₹100 (F)  
 (d) Material price variance = (3) – (4) = 6,900 – 7,370 = ₹ 470 (A)  
 (e) Material cost variance = (1) – (4) = 7,000 – 7,370 = ₹ 370 (A)

### Illustration 3

From the following you are required to calculate

- (a) Material Usage Variance  
 (b) Material Price Variance  
 (c) Material Cost Variance

Quantity of material purchased	3,000 units
Value of material purchased	₹ 9,000
Standard quantity of material required for one tonne of finished product	25 units
Standard rate of material	₹ 2 per unit
Opening stock of material	NIL
Closing stock of material	500 units
Finished production during the period	80 tonnes

### Solution:

#### Given Values:

SQ = Standard Quantity for Actual Production = 25 x 80 = 2,000 units.

AQ = Actual Quantity = 2,500 units (3,000 units – 500 units)

SP = Standard Price = ₹ 2

AP = Actual Price = ₹ 3

**(1) SQSP** = Standard Cost of Standard Material = 2,000 x 2 = ₹4,000

**(2) AQSP** = Standard Cost of Actual Material = 2,500 x 2 = ₹ 5,000

**(3) AQAP** = Actual Cost of Material = ₹ 7,500 (2,500 units × ₹ 3 per unit)

### Computation Of Material Variances:

- a. Material usage variance = (1) – (2) = ₹ (4,000 – 5,000) = ₹ 1,000 (A)  
 b. Material price variance = (2) – (3) = ₹ (5,000 – 7,500) = ₹ 2,500 (A)  
 c. Material cost variance = (1) – (3) = ₹ (4,000 – 7,500) = ₹ 3,500 (A)

**Illustration 4**

From the following information, compute (a) Mix, Price and Usage Variances.

	Quantity (Kg.)	Unit Rate (₹)	Total (₹)
<b>Standard:</b>			
Material A	10	2	20
Material B	20	3	60
Material C	20	6	120
	<b>50</b>		<b>200</b>
<b>Actual:</b>			
Material A	5	3	15
Material B	10	6	60
Material C	15	5	75
	<b>30</b>		<b>150</b>

**Solution:****Computation of Required Values**

				Amount (₹)
Materials	(1) SQSP	(2) RSQSP	(3) AQSP	(4) AQAP
A	10 x 2 = 20	6 x 2 = 12	5 x 2 = 10	5 x 3 = 15
B	20 x 3 = 60	12 x 3 = 36	10 x 3 = 30	10 x 6 = 60
C	20 x 6 = 120	12 x 6 = 72	15 x 6 = 90	15 x 5 = 75
	<u>200</u>	<u>120</u>	<u>130</u>	<u>150</u>

RSQ For A =  $10/50 \times 30 = 6$  units

RSQ For B =  $20/50 \times 30 = 12$  units

RSQ For C =  $20/50 \times 30 = 12$  units

Where (1) **SQSP** = Standard Cost of Standard Material = ₹ 200

(2) **RSQSP** = Revised Standard Cost of Material = ₹ 120

(3) **AQSP** = Standard Cost of Actual Material = ₹ 130

(4) **AQAP** = Actual Cost of Material = ₹ 150

**Computation of Required Variances**

(a) Material Sub-Usage Variance = (1) – (2) = ₹ 200 – ₹ 120 = ₹80 (F)

(b) Material Mix Variance = (2) – (3) = ₹ 120 – ₹ 130 = ₹10 (A)

(c) Material Usage Variance = (1) – (3) = ₹ 200 – ₹130 = ₹70 (F)

(d) Material Price Variance = (3) – (4) = ₹130 – ₹150 = ₹20 (A)

(e) Material Cost Variance = (1) – (4) = ₹ 200 – ₹ 150 = ₹50 (F)





**Illustration 5**

From the data given below, calculate the Material Price Variance, Material Usage Variance and Material Mix Variance:

Raw Material	Standard	Actual
A	40 units @ ₹50 per unit	50 units @ ₹50 per unit
B	60 units @ ₹40 per unit	60 units @ ₹45 per unit

**Solution:**

Amount (₹)

Material	Q	P	Value	Q	P	Value
A	40	50	2,000	50	50	2,500
B	60	40	2,400	60	45	2,700
	100		4,400	110		5,200

**Computation of Required Values**

Amount (₹)

Material	(1)SQSP	(2) RSQSP	(3) AQSP	(4) AQAP
A	40 x 50 = 2,000	44 x 50 = 2,200	50 x 50 = 2,500	50 x 50 = 2,500
B	60 x 40 = 2,400	66 x 40 = 2,640	60 x 40 = 2,400	60 x 45 = 2,700
	4,400	4,840	4,900	5,200

RSQ For A =  $40/100 \times 110 = 44$  units

RSQ For B =  $60/100 \times 110 = 66$  units

Where (1) SQSP = Standard Cost of Standard Material = ₹ 4,400

(2) RSQSP = Revised Standard Cost of Material = ₹ 4,840

(3) AQSP = standard Cost of Actual Material = ₹ 4,900

(4) AQAP = Actual Cost of Material = ₹ 5,200

**Computation of Required Variances:**

(a) Material Sub-Usage Variance = (1) – (2) = ₹ 440 (A) [₹ 4,400 – ₹ 4,840]

(b) Material Mix Variance = (2) – (3) = ₹ 60 (A) [₹ 4,840 – ₹ 49,00]

(c) Material Usage Variance = (1) – (3) = ₹ 500 (A) [₹ 4,400 – ₹ 4,900]

(d) Material Price Variance = (3) – (4) = ₹ 300 (A) [₹ 4,900 – ₹ 5,200]

(e) Material Cost Variance = (1) – (4) = ₹ 800 (A) [₹ 4,400 – ₹ 5,200]

**Illustration 6**

The standard material cost for 100 kg of chemical D is made up :

Chemical A 30 kg. @ ₹ 4 per kg

Chemical B 40 kg. @ ₹ 5 per kg

Chemical C 80 kg. @ ₹ 6 per kg



In a batch 500 kg. of chemical D were produced from a mix of

Chemical A 140 kg. @ ₹ 588

Chemical B 220 kg. @ ₹ 1,056

Chemical C 440 kg. @ ₹ 2,860

How do you yield mix and price of factors contribute to the variance in the actual cost per 100 kg. of chemical D over the standard cost ?

**Solution:**

### Analysis of Given Data

Amount (₹)

Chemical	Standard Data			Actual Data		
	Quantity	Price	Value	Quantity	Price	Value
A	30	4	120	28		117.60
B	40	5	200	44		211.20
C	80	6	480	88		572.00
	150		800	160		900.80
Less: Loss	50		-	60		-
	100		800	100		900.80

### Computation of Required Values

Amount (₹)

Chemical	(1) SQSP (₹)	(2) RSQSP (₹)	(3) AQSP (₹)	(4) AQAP (₹)
A	$30 \times 4 = 120$	$32.00 \times 4 = 128.00$	$28 \times 4 = 112.00$	117.60
B	$40 \times 5 = 200$	$42.67 \times 5 = 213.35$	$44 \times 5 = 220.00$	211.20
C	$80 \times 6 = 480$	$85.33 \times 6 = 512.00$	$88 \times 6 = 528.00$	572.20
	800.00	853.35	860.00	900.80

Computation of RSQ:

$$RSQ = \left( \frac{SQ \text{ for that product}}{SQ \text{ for all product}} \right) \times AQ \text{ for that product}$$

$$\text{For A} = \left( \frac{30}{150} \right) \times 160 = 32.00 \text{ units.}$$

$$\text{For B} = \left( \frac{40}{150} \right) \times 160 = 42.67 \text{ units.}$$

$$\text{For C} = \left( \frac{80}{150} \right) \times 160 = 85.33 \text{ units.}$$

- Where
- (1) SQSP = Standard cost for Standard material = ₹ 800
  - (2) RSQSP = Revised standard cost of material = ₹ 853.35
  - (3) AQSP = Standard cost of actual material = ₹ 860.00
  - (4) AQAP = Actual cost of material = ₹ 900.80



### Computation of Required Variances

- (a) Material Yield variance = (1) – (2) = ₹53.35 (A) [₹800 – ₹853.35]
- (b) Material Mix variance = (2) – (3) = ₹6.65 (A) [₹853.35 – ₹860]
- (c) Material usage variance = (1) – (3) = ₹60 (A) [₹800 – ₹860]
- (d) Material price variance = (3) – (4) = ₹40.80 (A) [₹860 – ₹900.80]
- (e) Material cost variance = (1) – (4) = ₹100.80 (A) [₹800 – ₹900.80]

### Illustration 7

Material	Standard Quantity (Kg.)	Price (₹)	Total (₹)
A	500	6.00	3,000
B	400	3.75	1,500
C	300	3	900
	1,200		5,400
Less: 10% Normal loss	120		
	1,080		5,400

Material	Actual Quantity	Price	Total
A	400	6.00	2,400
B	500	3.60	1,800
C	400	2.80	1,120
	1,300		5,320
Less: Actual loss	220		
	1,080		5,320

Calculate:

- a. Material Cost Variance
- b. Material Price Variance
- c. Material Mix Variance
- d. Material Yield Variance
- e. Material Usage Variance

**Solution:**

#### Computation of Required Values

Amount (₹)

	SQSP (1)	RSQSP (2)	AQSP (3)	AQAP (4)
A	3,000	541.67 x 6 = 3,250	400 x 6 = 2,400	2,400
B	1,500	433.33 x 3.75 = 1,625	500 x 3.75 = 1,875	1,800
C	900	325 x 3 = 975	400 x 3 = 1,200	1,120
	5400	5,850	5,475	5,320

**Computation of RSQ**

$$\text{For A} = \left( \frac{500}{1,200} \right) \times 1,300 = 541.67 \text{ units.}$$

$$\text{For B} = \left( \frac{400}{1,200} \right) \times 1,300 = 433.33 \text{ units.}$$

$$\text{For C} = \left( \frac{300}{1,200} \right) \times 1,300 = 325.00 \text{ units.}$$

Where

1. **SQSP** = Standard Cost for Standard Material = ₹ 5,400
2. **RSQSP** = Revised Standard Cost of Material = ₹ 5,850
3. **AQSP** = Standard Cost of Actual Material = ₹ 5,475
4. **AQAP** = Actual Cost of Material = ₹ 5,320

**Computation of Required Variances**

- a. Material Yield Variance = (1) – (2) = ₹ 450 (A) [₹(5,400 – 5,850)]
- b. Material Mix Variance = (2) – (3) = ₹ 375 (F) [₹(5,850 – 5,475)]
- c. Material usage variance = (1) – (3) = ₹75 (A) [₹(5,400 – 5,475)]
- d. Material price variance = (3) – (4) = ₹155 (F) [₹(5,475 – 5,320)]
- e. Material cost variance = (1) – (4) = ₹80 (F) [₹(5,400 – 5,320)]

**Illustration 8**

A manufacturing concern which has adopted standard costing furnishes the following information.

**Standard**

Material for 70 Kg of finished product of 100 Kg

Price of materials Re.1 per kg

**Actual**

Output	2,10,000 kg.
Material used	2,80,000 kg.
Cost of materials	₹ 2,52,000

Calculate:

- a. Material Usage Variance
- b. Material Price Variance
- c. Material cost Variance

**Solution:****Computation of Required Values**

Amount (₹)

(1) SQSP	(2) AQSP	(3) AQAP
$[2,10,000 \times 100/70] \times 1$	$2,80,000 \times 1$	
3,00,000	2,80,000	2,52,000

**Computation of Required Variances:**

- Material Usage Variance = (1) – (2) = ₹ 20,000 (F)
- Material Price Variance = (2) – (3) = ₹ 28,000(F)
- Material Cost Variance = (1) – (3) = ₹ 48,000(F)

**Illustration 9**

The standard set for material consumption was 100kg. @ ₹ 2.25 per kg.

In a cost period:

Opening stock was 100 kg. @ ₹ 2.25 per kg.

Purchases made 500 kg. @ ₹ 2.15 per kg.

Consumption 110 kg.

Calculate: (a) Usage (b) Price variance

(1) When variance is calculated at point of purchase

(2) When variance is calculated at point of issue on FIFO basis

(3) When variance is calculated at point of issue on LIFO basis

**Solution:****(a) Computation of Material Usage Variance**

$$\begin{aligned}
 \text{Material Usage Variance} &= \text{SQSP} - \text{AQSP} \\
 &= \text{SP} (\text{SQ} - \text{AQ}) \\
 &= 2.25(100-110) \\
 &= 22.50 \text{ (A)}
 \end{aligned}$$

**(b) Computation of Price variance****(1) When Variance is calculated at the point of purchase:**

$$\begin{aligned}
 \text{Price variance} &= \text{AQSP} - \text{AQAP} \\
 &= (110 \times 2.25) - (110 \times 2.15) \\
 &= 11 \text{ (F)}
 \end{aligned}$$

**(2) When variance is calculated at the point of issue on FIFO basis**

$$\begin{aligned} \text{Price variance} &= \text{AQSP} - \text{AQAP} \\ &= (110 \times 2.25) - ([100 \times 2.25] + [10 \times 2.15]) \\ &= 1 \text{ (F)} \end{aligned}$$

**(3) When variance is calculated at the point of issue on LIFO basis**

$$\begin{aligned} \text{Price variance} &= \text{AQSP} - \text{AQAP} \\ &= (110 \times 2.25) - (110 \times 2.15) \\ &= 247.50 - 236.50 \\ &= 11 \text{ (F)} \end{aligned}$$

**Illustration 10**

Using the following information calculate each of three labour variance for each department.

		Dept X	Dept Y
Gross wages direct	(₹)	28,080	19,370
Standard hours produced		8,640	6,015
Standard rate per hour	(₹)	3	3.40
Actual hours worked		8,200	6,395

**Solution:****Dept. X : Computation of Required Values**

SRSH (1)	SRAH (2)	ARAH (3)
3 x 8640	3 x 8200	
₹ 25,920	₹ 24,600	₹ 28080

1. SRSH = Standard Cost of Standard Labour
2. SRAH = Standard Cost of Actual Labour
3. ARAH = Actual Cost of Labour
  - a. Labour Efficiency Variance = (1) – (2) = ₹ 1,320 (F) [₹ (25,920 – 24,600)]
  - b. Labour Rate Variance = (2) – (3) = ₹ 3,480 (A) [₹ (24,600 – 28,080)]
  - c. Labour Cost Variance = (1) – (3) = ₹ 2,160 (A) [₹ (25,920 – 28,080)]

**Dept. Y Computation of Required Values**

Amount (₹)

SRSH (1)	SRAH (2)	ARAH (3)
3.4 x 6,015	3.4 x 6,395	
₹ 20,451	₹ 21,743	₹ 19,370

- a. Labour efficiency variance = (1) – (2) = ₹ 1,292 (A)
- b. Labour rate variance = (2) – (3) = ₹ 2,373 (F)
- c. Labour Cost Variance = (1) – (3) = ₹ 1,081 (F)



**Illustration 11**

Calculate variances from the following:

STANDARD				ACTUAL			
INPUT	MATERIAL	(₹)/KG	TOTAL	INPUT	MATERIAL	(₹)/KG	TOTAL
400	A	@ 50	20,000	420	A	@ 45	18,900
200	B	@20	4,000	240	B	@ 25	6,000
100	C	@15	1,500	90	C	@15	1,350
700			25,500	750			26,250
<b>LABOUR HOURS</b>				<b>LABOUR HOURS</b>			
	100 @ ₹2 per hour	200			120 @ ₹2.50 per hour	300	
	200 woman @ ₹ 1.50	300	500		240 woman @ ₹ 1.60	384	684
25	Normal Loss			75	Actual Loss		
675			26000	675			26,934

**Solution:**

**Calculation of Material Variances**

Amount (₹)

	(1) SQSP	(2) RSQSP	(3) AQSP	(4) AQAP
A		428.57 x 50	420 x 50	
B		214.29 x 20	240 x 20	
C		107.14 x 15	90 x 15	
A	20,000	21,429	21,000	18,900
B	4,000	4,289	4,800	6,000
C	1,500	1,607	1,350	1,350
	25,500	27,325	27,150	26,250

RSQ for

$$A = 400/700 \times 750 = 428.67 \text{ units}$$

$$B = 200/700 \times 750 = 214.29 \text{ units}$$

$$C = 100/700 \times 750 = 107.14 \text{ units}$$

1. SQSP = Standard Cost of Standard Material = ₹ 25,500
2. RSQSP= Revised Standard Cost of Material = ₹ 27,325
3. AQSP= Standard Cost of Actual Material = ₹ 27,150
4. AQAP = Actual Cost of Material = ₹ 26,250
  - a. Material Yield Variance (1-2) = ₹ 1,825 (A)
  - b. Material Mix Variance (2-3) = ₹ 175 (F)
  - c. Material Usage Variance (1-3) = ₹ 1,650 (A)
  - d. Material Price Variance (3-4) = ₹ 900 (F)
  - e. Material Cost Variance (1-4) = ₹ 750 (A)



## Calculation of Labour Variances

Amount (₹)

	(1)	(2)	(3)	(4)
	<b>SRSH</b>	<b>SRRSH</b>	<b>SRAH</b>	<b>ARAH</b>
Men		2 x 107.14	2 x 120	
Women		1.50 x 214.28	1.50 x 240	
Men	200	214.28	240	300
Women	300	321.42	360	384
	₹ 500	₹ 536	₹ 600	₹ 684

RSH for

Men =  $100/700 \times 750 = 107.14$  units.Women =  $200/700 \times 750 = 214.28$  units.

1. SRSH = Standard Cost of Standard Labour = ₹ 500
2. SRRSH = Revised Standard Cost of Labour = ₹ 536
3. SRAH = Standard Cost of Actual Labour = ₹ 600
4. ARAH = Actual Cost of Labour = ₹ 684
  - a. Labour Yield Variance (1-2) = ₹ 36 (A)
  - b. Labour Mix Variance (2-3) = ₹ 64 (A)
  - c. Labour Efficiency Variance (1-3) = ₹ 100 (A)
  - d. Labour Rate Variance (3-4) = ₹ 84 (A)
  - e. Labour Cost Variance (1-4) = ₹ 184 (A)

**Illustration 12**

The standard labour complement and the actual labour complement engaged in a week for a job are as under:

	<b>Skilled workers</b>	<b>Semi-skilled workers</b>	<b>Unskilled workers</b>
a) Standard no. of workers in the gang	32	12	6
b) Standard wage rate per hour (₹)	3	2	1
c) Actual no. of workers employed in the gang during the week	28	18	4
d) Actual wage rate per hour (₹)	4	3	2

During the 40 hour working week the gang produced 1,800 standard labour hours of work. Calculate

- 1) Labour Efficiency Variance
- 2) Mix Variance
- 3) Rate of Wages Variance
- 4) Labour Cost Variance





**Solution:**

**Analysis of Given Data**

Amount (₹)

	Standard Data			Actual Data		
	Hours	Rate	Value	Hours	Rate	Value
Skilled	32 × 40 = 1,280	3	3,840	28 × 40 = 1,120	4	4,480
Semi skilled	12 × 40 = 480	2	960	18 × 40 = 720	3	2,160
Unskilled	6 × 40 = 240	1	240	4 × 40 = 160	2	320
	2,000		5,040	2,000		6,960

**Computation of Required Values**

Amount (₹)

	SRS (1)	SRRS (2)	SRAH (3)	ARAH (4)
Men	3 × 1,152 = 3,456	3,840	3 × 1,120 = 3,360	4,480
Women	2 × 432 = 864	960	2 × 720 = 1,440	2,160
Boys	1 × 216 = 216	240	1 × 160 = 160	320
	4,536	5,040	4,960	6,960

**Computation of SH**

$$SH = \left( \frac{\text{SH for that worker}}{\text{SH for all the worker}} \right) \times AQ \text{ for that worker}$$

$$\text{For Skilled worker} = \left( \frac{1,280}{2,000} \right) \times 1,800 = 1,152$$

$$\text{For Semiskilled worker} = \left( \frac{480}{2,000} \right) \times 1,800 = 432$$

$$\text{For Unskilled worker} = \left( \frac{240}{2,000} \right) \times 1,800 = 216$$

Where (1) SRS = Standard Cost of Standard Labour = ₹ 4,536

(2) SRRS = Revised Standard Cost of Labour = ₹ 5,040

(3) SRAH = Standard Cost of Actual Labour = ₹ 4,960

(4) ARAH = Actual Cost of Labour = ₹ 6,960

**Computation of Labour Variances**

a. Labour Sub-Efficiency Variance = (1) – (2) = ₹ 504 (A) [₹(4,536 – 5,040)]

b. Labour Mix or Gang Variance = (2) – (3) = ₹80 (F) [₹(5,040 – 4,960)]



- c. Labour Efficiency Variance = (1) – (3) = ₹424 (A) [₹(4,536 – 4,960)]  
 d. Labour Rate Variance = (3) – (4) = ₹2,000 (A) [₹(4,960 – 6,960)]  
 e. Labour Cost Variance = (1) – (4) = ₹2,424 (A) [₹(4,536 – 6,960)]

**Illustration 13**

A chemical company gives you the following standard and actual data of its Chemical No.1456. You are required to calculate variances (material).

**Standard Data**

450	kg. of Material A @ ₹20 per kg.	9,000
360	kg. of Material B @ ₹10 per kg.	3,600
810		12,600
	2,400 Skilled hours @ ₹2	4,800
	1,200 Unskilled hours @ ₹1	1,200
		<b>6,000</b>
90	Normal loss	
720		18,600

**Actual Data**

450	kg. of Material A @ ₹19 per kg.	8,550
360	kg. of Material B @ ₹11 per kg.	3,960
810		12,510
	2,400 Skilled hours @ ₹2.25	5,400
	1,200 Unskilled hours @ ₹1.25	1,500
		<b>6,900</b>
50	Normal loss	
760		19,410

**Solution:****Computation of Required Values**

Material	SQSP (1)	RSQSP (2)	AQSP (3)	AQAP (4)
A	475 x 20 = 9,500	9,000	450 x 20 = 9,000	
B	380 x 10 = 3,800	3,600	360 x 10 = 3,600	
	13,300	12,600	12,600	12,510

**Computation of SQ:**

$$SQ = \left( \frac{\text{SQ for that material}}{\text{SQ for all material}} \right) \times \text{AQ for that material}$$

$$\text{For A} = \left( \frac{450}{720} \right) \times 760 = 475 \text{ units.}$$

$$\text{For B} = \left( \frac{360}{720} \right) \times 760 = 380 \text{ units.}$$

- Where
- (1) SQSP = Standard Cost of standard Material = ₹ 13,300
  - (2) RSQSP = Revised Standard Cost of Material = ₹ 12,600
  - (3) AQSP = Standard Cost of Actual Material = ₹ 12,600
  - (4) AQAP = Actual Cost of Material = ₹ 12,510.

**Computation of Required Variances**

- a. Material Yield Variance = (1) – (2) = ₹700 (F) [₹(13,300 – 12,600)]
- b. Material Mix Variance = (2) – (3) = Nil [₹(12,600 – 12,600)]
- c. Material Usage Variance = (1) – (3) = ₹700 (F) [₹(13,300 – 12,600)]
- d. Material Price Variance = (3) – (4) = ₹90 (F) [₹(12,600 – 12,510)]
- e. Material Cost Variance = (1) – (4) = ₹790 (F) [₹(13,300 – 12,510)]



## GLOSSARY

**Basic Standard:** Basic standard is the standard established for use over a long period from which a current standard can be developed.

**Current Standard:** Current standard is a standard which is established for use over a short period of time and is related to current conditions.

**Idle Time Variance:** Idle time variance is the standard cost of actual time paid to workers for which they have not worked due to abnormal reasons.

**Labour Cost Variance:** Labour cost variance is the difference between the actual labour costs and the standard labour costs.

**Labour Efficiency Variance:** Labour efficiency variance is the difference between the standard hours which should have been worked and the hours actually worked, valued at the standard wage rate.

**Labour Mix Variance:** Labour mix variance is the variance which arises due to change in the composition of a standard group, or, combination of labour force.

**Labour Rate Variance:** Labour rate variance is the difference between the actual and standard wage rate per hour applied to the total hours worked.

**Labour Yield Variance:** Labour yield variance is the variation in labour cost on account of increase or decrease in yield or output as compared to the relative standard.

**Material Cost Variance:** Material cost variance is the difference between standard material costs and actual material costs.

**Material Mix Variance:** Material mix variance is that part of material usage variance which arises from the difference between the standard mix and actual mix of different types of materials used in production.

**Material Price Variance:** Material price variance is the difference between the actual and standard price per unit of the material applied to the actual quantity of material purchased or used.

**Material Usage Variance:** Material usage variance is a part of material cost variance which reveals the deviation due to difference in quantity of material used.

**Material Yield Variance:** Material yield variance is the difference between the standard cost of production achieved and the actual total quantity of materials used, multiplied by the standard weighted average price per unit.

**Standard Cost:** Standard cost is a pre-determined cost which shows in advance what each product should cost under the given situation.

**Standard Costing:** Standard costing is a technique which uses standards for costs and revenue for the purpose of control through variance analysis.

**Standard Price:** Standard price is a pre-determined price fixed on the basis of a specification of a product or service and of all factors affecting the price.

**Standard Time:** Standard time is the total time in which a task should be completed at standard performance, i.e. basic time plus contingency time allowance plus allowance for relaxation.

**Variance:** The deviation of actual from standard is called variance. When actual cost is less than the standard cost, it is known as 'favourable variance'. When actual cost is more than the standard cost, it is known as 'unfavourable or adverse variance'. It is also referred to as a measure of dispersion defined as the mean squared deviation from the expected value.

**Variance Analysis:** Variance analysis is the analysis of variances arising in standard costing system into their constituent parts.



**Theoretical Questions:**

1. Write short notes on :
  - (a) Process of setting standards
  - (b) Types of standards
  - (c) Material yield variance
  - (d) Labour mix variance

**MULTIPLE CHOICE QUESTIONS:**

1. Excess of actual cost over standard cost is known as
  - A. Abnormal effectiveness
  - B. Unfavourable variance
  - C. Favourable variance
  - D. None of these.
2. Difference between standard cost and actual cost is called as
  - A. Wastage
  - B. Loss
  - C. Variance
  - D. Profit
3. Standards cost is used
  - A. To ascertain the breakeven point
  - B. To establish cost-volume profit relationship
  - C. As a basis for price fixation and cost control through variance analysis.
4. The cost of the product determined at the beginning of production under standard cost system is known as :
  - A. Actual cost
  - B. Direct cost
  - C. Pre-determined cost
  - D. Historical cost
  - E. None of the above
5. The deviation between standard and actual cost is known as
  - A. Variable cost analysis
  - B. Variance analysis
  - C. Linear trend analysis
  - D. Multiple analysis
  - E. None of the above



6. From cost control point of view the standard most commonly used is:
  - A. Expected standard
  - B. Theoretical standard
  - C. Normal standard
  - D. Basic standard
  - E. None of the above
7. When more than one material is used in the manufacture of a product, which of the following variances arises:
  - A. Material yield variance
  - B. Material mix variance
  - C. Material price variance
  - D. Material usage variance
  - E. None of the above
8. Standard price of material per kg ₹20, standard consumption per unit of production is 5 kg. Standard material cost for producing 100 units is
  - A. ₹ 20,000
  - B. ₹ 12,000
  - C. ₹ 8,000
  - D. ₹ 10,000
9. Standard cost of material for a given quantity of output is ₹ 15,000 while the actual cost of material used is ₹ 16,200. The material cost variance is:
  - A. ₹ 1,200 (A)
  - B. ₹ 16,200 (A)
  - C. ₹ 15,000 (F)
  - D. ₹ 31,200 (A)
10. For the purpose of Proof, Material Cost Variance is equal to:
  - A. Material Usage Variance + Material Mix variance
  - B. Material Price Variance + Material Usage Variance
  - C. Material Price Variance + Material yield variance
  - D. Material Mix Variance + Material Yield Variance
11. Cost variance is the difference between
  - A. The standard cost and marginal cost
  - B. The standards cost and budgeted cost
  - C. The standards cost and the actual cost
  - D. None of these



12. Standard price of material per kg is ₹ 20, standard usage per unit of production is 5 kg. Actual usage of production 100 units is 520 kgs, all of which was purchase at the rate of ₹ 22 per kg. Material usage variance is
- ₹ 400 (F)
  - ₹ 400 (A)
  - ₹ 1,040 (F)
  - ₹ 1,040 (A)
13. Standard price of material per kg is ₹ 20, standard usage per unit of production is 5 kg. Actual usage of production 100 units is 520 kgs, all of which was purchase at the rate of ₹ 22 per kg. Material cost variance is
- 2,440 (A)
  - 1,440 (A)
  - 1,440 (F)
  - 2,300 (F)
14. Standard quantity of material for one unit of output is 10 kgs. @ ₹ 8 per kg. Actual output during a given period is 800 units. The standards quantity of raw material
- 8,000 kgs
  - 6,400 Kgs
  - 64,000 Kgs
  - None of these
15. What is the labour rate variance if standard hours for 100 units of output are 400 @ ₹ 2 per hour and actual hours taken are 380 @ ₹ 2.25 per hour?
- ₹ 120 (adverse)
  - ₹ 100 (adverse)
  - ₹ 95 (adverse)
  - ₹ 25 (favourable)
  - None of the above

[Ans: B, C, C, C, B, A, B, D, A, B, C, B, B, A, C]

**State whether the statements are True or False:**

- Excess of Actual cost over Standards Cost is treated as unfavourable variance.
- Variations are calculated for both material and labour.
- While fixing standards, normal losses and wastages are taken into account.
- Under the system of standard costing, there is no need for variance analysis.
- Standard costing is an ideal name given to the estimate making.
- Standards cost, once fixed cannot be altered.



7. Predetermined standards provide a yardstick for the measurement of efficiency.
8. Material cost variance and labour cost variance are always equal.
9. Fixing standards is the work of industrial engineer or the production people and not of cost accountant.
10. Standards costing are more profitability employed in job order industries than in process type industries.

[Ans: T, T, T, F, F, T, T, F, F, F]

**Fill in the Blanks:**

1. Standard cost is a \_\_\_\_\_ cost.
2. Standard cost when fixed is recorded on \_\_\_\_\_ card.
3. Historical costing uses post period costs while standards costing uses \_\_\_\_\_ costs.
4. Three types of standards are \_\_\_\_\_.
5. The \_\_\_\_\_ is usually the co-ordinator of the standards committee.
6. Standards cost when fixed recorded on \_\_\_\_\_ card.
7. Basically there are two types of standards viz, a) Basic standards, and \_\_\_\_\_.
8. When actual cost is less than the standards cost, it is known as \_\_\_\_\_ variance.
9. Standard Costing is one of the \_\_\_\_\_ techniques.
10. Standard means a criterion or a yardstick against which actual activity can be compared to determine the \_\_\_\_\_ between two.

[Ans. Predetermined, Standard cost, Predetermined, Current, basic and Normal standard, Cost Accountants, Standard cost, Current standard, Favourable, Cost control, difference.]

**Match the following:**

	Column A		Column B
1.	Direct material yield variance	A	(Standard hour for actual production minus Actual hours) x Standard Rate
2.	Direct Labour rate variance	B	(Actual Hours at standard rate of standard gang) minus (Actual Hours at standards Rate of Actual Gang)
3.	Material price variance	C	Management by Exception
4.	Variance Analysis	D	(Standard Rate minus Actual Rate) x Actual hour
5.	Direct labour yield variance	E	(Standard rate x Actual hours paid for) minus (Standard rate x Actual hours worked)
6.	Direct Labour efficiency variance	F	(Standard price minus Actual Price) X Actual Quantity
7.	Direct material mix variance	G	(Standard Quantity for actual output X Standard Price) minus (Standard price X Actual Quantity)
8.	Gang variance	H	Standard cost per unit x (Standard output for actual mix – Actual output)
9.	Ideal time variance	I	(Standard yield for actual Mix minus Actual Yield) x Standard yields Price.
10.	Direct material usage variance	J	(Revised Standard Quantity minus Actual Quantity) X Standard Price

[Ans: I, D, F, C, H, A, J, B, E, G]





### 6.3 BUDGET AND BUDGETARY CONTROL

The literary meaning of the word Budget is a statement of income and expenditure of a certain period. In principle, the meaning is same in the context of business also. An individual will have his own budget, a family, a local authority, state and country etc. All will have their respective budgets. So also the business concern must have its budget so as to attain their objectives.

CIMA defines a budget as, "A budget is a financial and/or quantitative statement, prepared prior to a defined period of time, of the policy to be pursued during that period for the purpose of attaining a given objective."

#### Features of Budget

An analysis of the above definition reveals the following as features of the budget.

- (i) A Budget must be expressed either in quantitative form i.e., the number of units of different products or it may be expressed in rupees of each product or it may be quantitative and financial form i.e., the number of units and rupees of each product etc.,
- (ii) It must be prepared before the time for which it is required, for example, if budget is required for the year 2013-14, it must be prepared in the year 2012-13.
- (iii) Budget must be prepared for a definite period.
- (iv) Budget must be prepared in accordance with the policies of the business enterprise.
- (v) Budgets are prepared normally for attaining organisational objectives, because policies are formulated to achieve the objectives and those are translated into quantitative and financial form.

#### Objectives of the Budget

- (i) A budget is a blue print for the desired plan of action. Since budgets are prepared in accordance with the policies of various functions of the organisation such as purchase, production sales etc., these will be helpful as plan of action to discharge the above functions.
- (ii) Budgets are useful for forecasting the operating activities and financial position of a business enterprise.
- (iii) Budgets are helpful in establishing divisional and departmental responsibilities.
- (iv) Budgets provide a means of coordination for the business as a whole. When the budgets are established various factors such as production capacity, sales responsibilities, procurement of material, deployment of labour etc., are balanced and synchronised so that all the activities are processed according to the objective. Thereby Budgets are very much useful in coordination of factors and functions.
- (v) Budget ensures good business practice because they plan for future.
- (vi) Budgets are means of communication. The complex plans that are laid down by the top management are to be passed on to the operative personnel, those who actually put the plans into action. Budgets are very much helpful in processing such information to the lowest personnel in the organisation.
- (vii) Budgets are devised to obtain more economical use of capital and all other inputs.
- (viii) Budgets are more definite assurance of earning of the proper return on capital invested.
- (ix) Budgets facilitate centralised control with delegated responsibilities and authorities. Budgets are instruments of managerial control by means of which the management can measure the performances in every part of the business concerns and corrective action can be taken soon after deviations are found out.



### Essential elements of Budget

Following are the essential elements of budget:

- (i) Organisational structure must be clearly defined and responsibility should be assigned to identifiable units within the organisation.
- (ii) Clear objectives and reasonable targets should be set. Objectives should be in accordance with the long term plan of the organisation.
- (iii) Objectives and degree of responsibility should be clearly stated and communicated to the management or person responsible for.
- (iv) Budgets should be prepared for the future periods on the basis of expected course of actions.
- (v) Budgets should be updated for the events while establishing budgets.
- (vi) Budgets should be flexible enough for mid-term revision.
- (vii) The whole organisation must be committed to budgeting.
- (viii) Budgets should be quantifiable and a master budget should be classified into various functional budgets.
- (ix) Budgets should be monitored on periodical basis. Variances from the standard yardsticks should be analysed and responsibility should be fixed.
- (x) Budgetary performance should be linked to the reward system effectively.

### Preparation of Budget

The preparation of budget requires many importance activities as enumerated below:

1. Definition of Objective
2. Location of the Key or Budget Factor
3. Appointment of Budget Controller
4. Preparation and circulation of Budget Manual
5. Fixation of Budget Period
6. Determination of Standard activity or Output

In budgeting, fixation of the budget of sales and of capital expenditure is important as these budgets determine the extent of development activity.

### Limitations of Budgets

#### (i) Budgets fail if estimates are not accurate

Budgets mainly depend upon the accuracy of the estimates. So estimates should be made on the basis of all the information available. Though forecasting is not an exact science, accurate estimates can be made by using advanced statistical techniques. Thus preparation of budgets involves certain amount of judgment and proper interpretation of reports.

#### (ii) Risk of Rigidity

Budgeting process creates a sense of rigidity in the minds of people who are working in the organisation. But in the modern business world, which is more dynamic in nature, such rigidity will create problems. Therefore budgeting process should also be dynamic in nature, so that it can be updated according to the situation.



### (iii) Budgeting is an expensive process

The installation and implementation of the budgeting process involves too much time and costs. Therefore small organisations can not afford to it. Even for large organisations cost benefit analysis should be conducted before installing such a system. It can be adopted only if the benefits exceed the costs.

### (iv) Budgeting is not a substitute for management

Budgeting is only a tool for management. Installation of Budgeting system does not relieve the managers from their duties. It involves only in effective management of the resources of the organisation. It is only a misconception to think that the introduction of budgeting is alone sufficient to ensure success and to guarantee future profits. It is only a means for achieving the end.

### (v) Continuous monitoring is required

Installation of budgeting system does not imply that it is effectively implemented. Management must continuously monitor the operating system (whether the goals intended) how far the plans and budgets are helpful in achieving the goals of the organisation.

## Classification of Budgets

Budgets are broadly classified based on :

- (A) Time
- (B) Nature of expenditure and receipts
- (C) Functions
- (D) Capacity

Let us discuss the budgets as per above classification in detail.

### (A) ON THE BASIS OF TIME

- (i) **Long term budget:** Though there is no exact definition of long term budget, yet we can say that a budget prepared covering a period of more than a year can be taken as long term budget. Of course, it may be for 3 years, 5 years, 10 years and even 20 years etc.,
- (ii) **Short term budget:** It is a budget prepared for a period covering a year or less than a year.

### (B) ON THE BASIS OF NATURE OF EXPENDITURE AND RECEIPTS

- (i) **Capital Budget:** It is a budget prepared for capital receipts and expenditure such as obtaining loans, issue of shares, purchase of assets, etc.,
- (ii) **Revenue Budget:** A Budget covering revenue receipts and expenses for a certain period is called Revenue Budget. Examples: Sales, other incomes, purchases, administrative expenses etc.,

### (C) ON THE BASIS OF FUNCTIONS

**Functional Budget:** If budgets are prepared of a business concern for a certain period taking each and every function separately such budgets are called functional budgets. Example: Production, Sales, purchases, cost of production, cash, materials etc.

### Types of Functional Budgets

The following are the various functional budgets, some of which are briefly explained here under:

- (i) **Sales Budget:** The sales budget is a forecast of total sales, expressed in terms of money or quantity or both. The first step in the preparation of the sales budget is to forecast as accurately as possible, the sales anticipated during the budget period. Sales forecasts are usually prepared by the sales manager assisted by the market research personnel.



### Factors to be considered in preparing Sales Budget

As business existence depends upon the sales it is going to make and therefore it is an important one to be prepared meticulously. It is the forecast of what it can reasonably sell to its customers during the period for which budget is prepared. The company's profit mostly depends upon the ability to sell its products to customers. In the present era it is indispensable to establish the demand for the product even before it is produced. It is the sales order book that the company's continuity depends upon. Also, a reasonable degree of accuracy must be there in preparing a sales budget unless its sales are accurately forecast, production estimates will also become erroneous. A good amount of experience must be necessary to prepare the sales budget. Yet the following factors must be considered in preparing the sales budget:

- (a) The locality of the market i.e., domestic or export
- (b) The target customers i.e., industry or trade or a section or group of general public etc.,
- (c) The product portfolio i.e., the number of products offered and their popularity among the target customers
- (d) The market share of each product and its influence on the product portfolio and the total market
- (e) The effectiveness of existing marketing policy on the current sales volume and value
- (f) The market share of competitor's products and their effect on the company's sales
- (g) Seasonal fluctuation in sales
- (h) Expenditure on advertisement and its impact on sales

**(ii) Production Budget:** The production budget is a forecast of the production for the budget period. Production budget is prepared in two parts, viz. production volume budget for the physical units of the products to be manufactured and the cost of production or manufacturing budget detailing the budgeted cost under material, labour, and factory overhead in respect of the products.

### Factors to be considered in Production Budget

Next to the sales budget, the main function of a business concern is the production and for this, a budget is prepared simultaneously with the sales budget. It is the forecast of production during the period for which the budget is prepared. It can also be prepared in two parts viz., production volume budget for the physical units i.e., the number of units, the tonnes of production etc., and the cost of production or manufacture showing details of all elements of the manufacture. While preparing the production budget, the following factors must be taken into consideration:-

#### (a) Production plan

Production planning is an important part of the preparation of the production budget. Optimum utilisation of plant capacity is taken by eliminating or reducing the limiting factors and thereby effective production planning is made.

#### (b) The capacity of the business concern

It is to be ensured that the capacity of the organisation will coincide the budgeted production or not. For this purpose, plant utilisation budget will also be necessary. The production budget must be based on normal capacity likely to be achieved and it should not be too high or too low.

#### (c) Inventory Policy

While preparing the production budget it is also necessary to see to what extent materials are available for producing the budgeted production. For that purpose, a purchase budget or a purchase plan must also be studied. Similarly, on the other hand, it is also necessary to verify the extent to which the inventory of finished goods is to be carried.



- (d) Sales budgets must also be considered before preparing production budget because it may so happen that the entire production of the concern may not be sold. In such a case the production budget must be in line with the sales budget.
- (e) A plan of the sequence of operations of production for effective preparation of a production budget should always be there.
- (f) Last, but not the least, the policy of the management should also be considered before preparing the production budget.

### Objectives and Advantages of Production budget

- Optimum utilisation of the productive resources of the organisation;
  - Maintaining low inventory which results in risk of deterioration and fall in prices;
  - Focus on the factors that are necessary to frame policies and plan sequence of operations;
  - Projection of policies framed, on the basis of past performance, into the future to get the desired results;
  - To see that right materials are provided at right place and at right time;
  - Helps in scheduling of production so that delivery dates are met and customer satisfaction is gained;
  - Helpful in preparation of projected profit and loss statement, which is useful in evaluation of performance and profitability.
- (iii) **Materials Budget:** The material budget includes quantities of direct materials; the quantities of each raw material needed for each finished product in the budget period is specified. The input data for this budget is obtained by applying standard material usage rates by each type of material to the volume of output budgeted.
- (iv) **Purchase Budget:** The purchase budget establishes the quantity and value of the various items of materials to be purchased for delivery at specified points of time during the budget period taking into account the production schedule of the concern and the inventory requirements. It takes into account the requirements for the entire budget plan as per the sales, materials, maintenance, research and development, and capital budgets. Purchases may be required to be made in respect of direct and indirect materials, finished goods for resale, components and parts, and purchased services. Before incorporation in the purchase budget, these purchase requirements should be suitably ascertained. Purchase budget also includes material procurement budget.
- (v) **Cash Budget:** Cash Budget is estimated receipts and expenses for a definite period, which usually are cash sales, collection from debtors and other receipts and expenses and payment to suppliers, payment of wages, payment of other expenses etc.
- (vi) **Direct Labour Budget or Personnel Budget:** This budget is based on: (a) Production Budget, (b) Sales Budget, (c) Capital expenses Budget, (d) Research and Development cost Budget, (e) possibility of new wage agreements.
- The main purposes of this budget are to: (1) help in the efficient labour management, (2) show the planned outlay on direct and indirect wages.
- (vii) **Selling and Distribution Cost Budget:** This budget is based on: (a) Sales budget, (b) Selling and Distribution cost budget for the current period, (c) Actual selling and distribution costs for the current period, (d) Expected changes in the rate of commission on sales, method of distribution, advertisement policy, etc.



- (viii) Administration Cost Budget:** This budget shows the total estimated cost of administration, i.e. cost of formulating the policy, directing the organisation and controlling the operations. Most of the expenses relating to administration are of 'fixed' nature within defined limits. This budget is easy to prepare. Formally each budget centre or department prepares its own budget which gets incorporated in this budget afterwards.
- (ix) Capital Expenditure Budget:** It is the planned outlay on fixed assets viz. Land, Building, Plant & Machinery etc. during the budget period. This budget is generally prepared for a long period, say 5 or 10 years. For control purposes, it is broken down into short periods. Preparation of this budget is the responsibility of Head of Accounts, who will be assisted by the plant manager and other functional heads, based on a number of information, e.g.
1. Plant utilisation budget
  2. Long term business policy
  3. Potential demand for certain products
- On the basis of information a company may decide for extension factory capacity, purchase of new and better factory equipments which will entail heavy capital expenditure.
- (x) Research and Development Budget (R & D Budget):** It is a planned outlay on R & D activities of a company. The budget covers materials, equipments and supplies, salaries, expenses, and other costs relating to design, development, and technical research projects.

**Master Budget:** Master budget is the budget prepared to cover all the functions of the business organisation. It can be taken as the integrated budget of business concern, that means, it shows the profit or loss and financial position of the business concern such as Budgeted Profit and Loss Account, Budgeted Balance Sheet etc. Master budget, also known as summary budget or finalized profit plan, combines all the budgets for a period into one harmonious unit and thus, it shows the overall budget plan. The master budget incorporates all the subsidiary functional budgets and the budgeted Profit and Loss Account and Balance Sheet. Before the budget plan is put into operation, the master budget is considered by the top management and revised if the position of profit disclosed therein is not found to be satisfactory. After suitable revision is made, the master budget is finally approved and put into action. Another view regards the budgeted Profit and Loss Account and the Balance Sheet as the master budget.

#### **(D) ON THE BASIS OF CAPACITY**

- (i) Fixed or Rigid budget:** When budgets are prepared for a fixed or standard volume of activity, they are called static or rigid or fixed budgets. They do not change with the changes in the volume of the output. These are prepared normally 3 months in advance of the year. However these will not be much helpful in comparing the actual activity, as these are prepared at a fixed volume of output. It, however, does not mean that the fixed budget is a rigid one, not to be changed at all. Though not adjusted to the actual volume attained, a fixed budget is liable to revision if due to business conditions undergoing a basic change or due to other reasons, actual operations differ widely from those planned in the fixed budget.

Fixed budgets are most suited for fixed expenses. In case of discretionary costs situations where the expenditure is optional and has no relation with the output, e.g. expenditure on research and development, advertising, and new projects. A fixed budget has only a limited application and is ineffective as a tool for cost control. Fixed budgets are useful where the plan permits maximum stabilization of production, as for example, for concerns which manufacture to build up inventories of finished products and components.



**(ii) Flexible Budget:** A flexible budget is a budget that is prepared for different levels of activity or capacity utilization or volume of output. If the budgets are prepared in such a way so as to change in accordance with the volume of output, they are called flexible budgets. These can be prepared from fixed budget which are also called revised budgets. These are much helpful in comparison with actual because the exact deviations are found for which timely corrective action can be taken. The basic idea of a flexible budget is that there shall be some standard of cost and expenditures. Thus, a budget prepared in a manner to give budgeted costs for any level of activity is known as flexible budget. Such budget is prepared after considering the variable and fixed elements of costs and the changes, which may be expected for each item at various levels of operations. Thus a flexible budget recognises the difference in behaviour between fixed and variable costs in relation to fluctuations in production or sales and is designed to change appropriately with such fluctuations. In flexible budget, data relating to costs, expenditures may progressively be changed in any month in accordance with actual output achieved. While preparing flexible budgets, estimates of costs and expenditures on the basis of standards determined are made from minimum to maximum level of operations.

**Difference between Fixed and Flexible Budgets**

	<b>Fixed / Rigid Budget</b>	<b>Flexible Budget</b>
(i)	It does not change with actual volume of activity achieved. Thus it is known as rigid or inflexible budget.	It can be recasted on the basis of activity level to be achieved. Thus it is not rigid.
(ii)	It operates on one level of activity and under one set of conditions. It assumes that there will be no change in the prevailing conditions, which is unrealistic.	It consists of various budgets for different levels of activity.
(iii)	Here as all costs like – fixed, variable and semi-variable are related to only one level of activity so variance analysis does not give useful information.	Here analysis of variance provides useful information as each cost is analysed according to its behaviour.
(iv)	If the budgeted and actual activity levels differ significantly, then the aspects like cost ascertainment and price fixation do not give a correct picture.	Flexible budgeting at different levels of activity facilitates the ascertainment of cost, fixation of selling price and tendering of quotations.
(v)	Comparison of actual performance with budgeted targets will be meaningless specially when there is a difference between the two activity levels.	It provides a meaningful basis of comparison of the actual performance with the budgeted targets.

**Principal Budget Factor**

Budgets cover all the functional areas of the organisation. For the effective implementation of the budgetary system, all the functional areas are to be considered which are interlinked. Because of these interlinks, certain factors have the ability to affect all other budgets. Such factor is known as principle budget factor.

Principal Budget factor is the factor the extent of influence of which must first be assessed in order to ensure that the functional budgets are reasonably capable of fulfillment. A principal budget factor may be lack of demand, scarcity of raw material, non-availability of skilled labour, inadequate working capital etc. If for example, the organisation has the capacity to produce 2500 units per annum. But the



production department is able to produce only 1800 units due to non-availability of raw materials. In this case, non-availability of raw materials is the principal budget factor (limiting factor). If the sales manager estimates that he can sell only 1500 units due to lack of demand. Then lack of demand is the principal budget factor. This concept is also known as key factor, or governing factor. This factor highlights the constraints within which the organisation functions.

### **BUDGETARY CONTROL**

Budgetary control is defined as “the establishment of budgets relating the responsibilities of executives to the requirements of a policy and the continuous comparison of actual with budgeted results, either to secure by individual action the objective of that policy or to provide a basis for its revision.”

#### **Steps for Budgetary Control**

From the above definition, the steps for Budgetary Control can be drawn as follows: -

##### **(i) Establishment of Budgets**

Budgetary control primarily aims at preparation of various budgets such as sales Budget, production budget, overhead expenses budget, cash budget etc.,

##### **(ii) Responsibilities of executives**

The budgetary control system is designed to fix responsibilities on executives through preparation of budgets.

##### **(iii) Policy making**

The established policies of the organisation are designed as budgets so as to fix responsibility on executives.

##### **(iv) Comparison of actuals with budgets**

After establishing the budgets, the actuals are compared with them and any deviations, if any are called variances.

##### **(v) Achieving the desired result**

The desired result of the budgetary control system is comparison of actuals with the budgeted results and the causes of variances, if any, are analysed.

##### **(vi) Reporting to Top Management**

After the causes of Variances are analysed, the variances and their causes are reported to top management so that the remedial action can be taken.

#### **Advantages of Budgetary Control**

- (i) Budgetary control aims at maximisation of profits through optimum utilisation of resources.
- (ii) It is a technique for continuous monitoring of policies and objectives of the organisation.
- (iii) It helps in reducing the costs, thereby helps in better utilisation of funds of the organisation.
- (iv) All the departments of the organisation are closely coordinated through establishment of plans resulting in smooth functioning of the organisation.
- (v) Since budgets fix the responsibilities of the executives, they act as a plan of action for them there by reducing some of their work.
- (vi) It facilitates analysis of variances, thereby identifying the areas where deficiencies occur and proper remedial action can be taken.





- (vii) It facilitates the management by exception.
- (viii) Budgets act as a motivating force to achieve the desired objective of the organisation.
- (ix) It assists delegation of authority and is a powerful tool of responsibility accounting.
- (x) It helps in stabilizing the conditions in industries which face seasonal fluctuations.
- (xi) It helps as a basis for internal audit.
- (xii) It provides a suitable basis for introducing the payment by results system.
- (xiii) It ensures adequacy of working capital to the organisation.
- (xiv) It aids in performance analysis and performance reporting system.
- (xv) It aids in obtaining bank credit.
- (xvi) Budgets are forerunners of standard costs in the sense that they create necessary conditions to suit setting up of standard costs.

### **ZERO-BASED BUDGETING (ZBB)**

Zero-Based Budgeting (ZBB) is a method of budgeting which requires each cost element to be specifically justified, though the activities to which the budget relates are being undertaken for the first time, without approval, the budget allowance is 'zero'. It is an activity based budgeting system in which budget is prepared for each activity and the justification in the form of cost-benefits for the activity is necessary to be given. The activities are evaluated and prioritised by the management based on the factors viz. availability of funds, regulatory requirement, parity with organisational objectives etc.

ZBB involves various stages: (a) identification of decision packages and their description in detail, (b) evaluation of decision packages, (c) selection of decision packages according to priority, and (d) allocation of resources after approval of the budget committee and the top management.

Zero-based budgeting is better than traditional budgeting due to following reasons:

- (i) It gives an opportunity for the management to allocate resources to various activities after a detailed cost benefit analysis.
- (ii) It helps the management to identify wasteful expenditure and eliminate them.
- (iii) It also facilitates the management in linking the functional budgets with corporate objectives.
- (iv) It facilitates introduction of a system of Management by Objectives (MBO).

### **RESPONSIBILITY ACCOUNTING**

One of the recent developments in the field of management accounting is the responsibility accounting, which is helpful in exercising cost control. 'Responsibility Accounting is a system of accounting that recognizes various responsibility centers throughout the organization and reflects the plans and actions of each of these centers by assigning particular revenues and costs to the one having the pertinent responsibility. It is also called profitability accounting and activity accounting.

It is a system in which the person holding the supervisory posts as president, function head, foreman, etc are given a report showing the performance of the company or department or section as the case may be. The report will show the data relating to operational results of the area and the items of which he is responsible for control. Responsibility accounting follows the basic principles of any system of cost control like budgetary control and standard costing. It differs only in the sense that it lays emphasis on human beings and fixes responsibilities for individuals. It is based on the belief that control can be exercised by human beings, so responsibilities should be fixed for individuals.



Principles of responsibility accounting are as follows:

- (a) A target is fixed for each department or responsibility center.
- (b) Actual performance is compared with the target.
- (c) The variances from plan are analysed so as to fix the responsibility.
- (d) Corrective action is taken by higher management and is communicated.

### PERFORMANCE BUDGETING

Performance Budgeting is synonymous with Responsibility Accounting which means thus the responsibility of various levels of management is predetermined in terms of output or result keeping in view the authority vested with them. The main concepts of such a system are enumerated below:

- (a) It is based on a classification of managerial level for the purpose of establishing a budget for each level. The individual in charge of that level should be made responsible and held accountable for its performance over a given period of time.
- (b) The starting point of the performance budgeting system rests with the organisation chart in which the spheres of jurisdiction have been determined. Authority leads to the responsibility for certain costs and expenses which are forecast or present in the budget with the knowledge of the manager concerned.
- (c) The costs in each individual's or department's budget should be limited to the cost controllable by him.
- (d) The person concerned should have the authority to bear the responsibility.

### Illustration 1

Prepare a Production Budget for three months ending March 31, 2016 for a factory producing four products, on the basis of the following information.

Type of Product	Estimated Stock on Jan. 1, 2016	Estimated Sales during Jan. to Mar. 2016	Desired closing stock on 31.3.2016
A	2,000	10,000	3,000
B	3,000	15,000	5,000
C	4,000	13,000	3,000
D	3,000	12,000	2,000

### Solution:

#### Production Budget for the 3 Months ending 31<sup>st</sup> March 2016

Particulars	Product A	Product B	Product C	Product D
Sales	10,000	15,000	13,000	12,000
Add: Closing Stock	3,000	5,000	3,000	2,000
	13,000	20,000	16,000	14,000
Less: Opening Stock	2,000	3,000	4,000	3,000
Production (Units)	11,000	17,000	12,000	11,000



**Illustration 2**

Budgeted production and production costs for the year ending 31st December are as follows:

	PRODUCT- X	PRODUCT -Y
Production (units)	2,20,000	2,40,000
Direct material/unit	₹ 12.5	₹19.0
Direct wages/unit	₹ 4.5	₹7.0
Total factory overheads for each type of product (variable)	₹ 6,60,000	₹9,60,000

A company is manufacturing two products X and Y. A forecast about the number of units to be sold in the first seven months is given below:

MONTH	JAN	FEB	MAR	APRIL	MAY	JUNE	JULY
Product – X	10,000	12,000	16,000	20,000	24,000	24,000	20,000
Y	28,000	28,000	24,000	20,000	16,000	16,000	18,000

It is anticipated that:

- (a) There will be no work-in-progress at the end of any month.
- (b) Finished units equal to half the sales for the next month will be in stock at the end of each month (including December of previous year).

Prepare for 6 months ending 30th June a Production Budget and a summarised cost of production budget.

**Solution:**

**Production Budget for 6 Months ending 30<sup>th</sup> June (Product X)**

Particulars	Jan	Feb	Mar	Apr	May	Jun
Sales	10,000	12,000	16,000	20,000	24,000	24,000
Add: Closing Stock	6,000	8,000	10,000	12,000	12,000	10,000
	16,000	20,000	26,000	32,000	36,000	34,000
Less: Opening Stock	5,000	6,000	8,000	10,000	12,000	12,000
Production (units)	11,000	14,000	18,000	22,000	24,000	22,000

Total Production of X for 6 months = 11,000 + 14,000 + 18,000 + 22,000 + 24,000 + 22,000 = 1,11,000 units.

**Production Budget for 6 Months ending 30<sup>th</sup> June (Product Y)**

Particulars	Jan	Feb	Mar	Apr	May	Jun
Sales	28,000	28,000	24,000	20,000	16,000	16,000
Add: Closing Stock	14,000	12,000	10,000	8,000	8,000	9,000
	42,000	40,000	34,000	28,000	24,000	25,000
Less: Opening Stock	14,000	14,000	12,000	10,000	8,000	8,000
Production (units)	28,000	26,000	22,000	18,000	16,000	17,000

Total production of Y for 6 months = 28,000 + 26,000 + 22,000 + 18,000 + 16,000 + 17,000 = 1,27,000 units.

**Summarised Cost of Production Budget for 6 Months Ending 30<sup>th</sup> June**

Amount (₹)

Particulars	Product X (1,11,000 units)	Product Y (1,27,000 units)	Total
Materials	13,87,500	24,13,000	38,00,500
Direct Wages	4,99,500	8,89,000	13,88,500
Variable Factory Overhead (wn)	3,33,000	5,08,000	8,41,000
Summarised cost of Production	22,20,000	38,10,000	60,30,000

**Working Notes:****1. Computation of Variable Factory Overhead**

$$\text{For Product X} = \left( \frac{6,60,000}{2,20,000} \times 1,11,000 \right) = 3,33,000$$

$$\text{For product Y} = \left( \frac{9,60,000}{2,24,000} \times 1,27,000 \right) = 5,08,000$$

**Illustration 3**

Draw a Material Procurement Budget (Quantitative) from the following information:

Estimated sales of a product 40,000 units. Each unit of the product requires 3 units of material A and 5 units of material B.

Estimated opening balances at the commencement of the next year:

Finished product = 5,000 units  
Material A = 12,000 units  
B = 20,000 units

Material on order:

Material A = 7,000 units  
Material B = 11,000 units

The desirable closing balance at the end of the next year:

Finished product = 7,000 units  
Material A = 15,000 units  
B = 25,000 units

Material on order:

Material A = 8,000 units  
B = 10,000 units



**Solution:**

$$\begin{aligned}
 \text{Production} &= \text{Sales} + \text{Closing Stock} - \text{Opening Stock} \\
 &= 40,000 + 7,000 - 5,000 \\
 &= 42,000 \text{ units}
 \end{aligned}$$

**Raw Materials Purchase Budget**

Particulars	Product A	Product B
Material Required	1,26,000 (42,000 x 3)	2,10,000 (42,000 x 5)
Add: Closing Stock	15,000	25,000
Add: Closing Stock on order	8,000	10,000
	1,49,000	2,45,000
Less: Opening Stock	12,000	20,000
Less: Opening Stock on order	7,000	11,000
Raw Material Purchase	1,30,000	2,14,000

**Illustration 4**

From the following figures prepare the raw material purchase budget for January, 2017:

	Materials					
	A	B	C	D	E	F
Estimated Stock on Jan 1	16,000	6,000	24,000	2,000	14,000	28,000
Estimated Stock on Jan 31	20,000	8,000	28,000	4,000	16,000	32,000
Estimated Consumption	1,20,000	44,000	1,32,000	36,000	88,000	1,72,000
Standard Price per Unit	25 p.	5 p.	15 p.	10 p.	20 p.	30 p.

**Solution:**

**Raw Materials Purchase Budget For January 2015**

Type	A	B	C	D	E	F	Total
Estimated Consumption (units)	1,20,000	44,000	1,32,000	36,000	88,000	1,72,000	
Add: Estimated stock on Jan 31, 2017 (units)	20,000	8,000	28,000	4,000	16,000	32,000	
	1,40,000	52,000	1,60,000	40,000	1,04,000	2,04,000	
Less: Estimated stock on Jan1, 2017 (units)	16,000	6,000	24,000	2,000	14,000	28,000	
Estimated purchase (units)	1,24,000	46,000	1,36,000	38,000	90,000	1,76,000	6,10,000
Rate per unit (₹)	0.25	0.05	0.15	0.10	0.20	0.30	
Estimated purchases (₹)	31,000	2,300	20,400	3,800	18,000	52,800	1,28,300

**Illustration 5**

A company manufactures product - A and product -B during the year ending 31st December 2016, it is expected to sell 15,000 kg. of product A and 75,000 kg. of product B at ₹30 and ₹16 per kg. respectively. The direct materials P, Q and R are mixed in the proportion of 3: 5: 2 in the manufacture of product A, Materials Q and R are mixed in the proportion of 1:2 in the manufacture of product B. The actual and budget inventories for the year are given below:

	Opening Stock	Expected Closing stock	Anticipated cost per Kg.
	Kg.	Kg.	₹
Material – P	4,000	3,000	₹12
Material –Q	3,000	6,000	10
Material – R	30,000	9,000	8
Product - A	3,000	1,500	—
B	4,000	4,500	—

Prepare the Production Budget and Materials Budget showing the expenditure on purchase of materials for the year ending 31-12-2016.

**Solution:****Production Budget for the Products A & B**

Particulars	Product A	Product B
Sales	15,000	75,000
Add: Closing Stock	1,500	4,500
	16,500	79,500
Less: Opening Stock	3,000	4,000
Production	13,500	75,500

**Material Purchase Budget for the Year ending Dec 31<sup>st</sup> 2016**

Particulars	P	Q	R	Total
Material required for product A in the ratio of 3:5:2	4,050	6,750	2,700	13,500
Material required for product B in the ratio of 1:2	-	25,167	50,333	75,500
Total requirement	4,050	31,917	53,033	
Add: Closing Stock	3,000	6,000	9,000	
	7,050	37,917	62,033	
Less: Opening Stock	4,000	3,000	30,000	
Purchases (in units)	3,050	34,917	32,033	
Cost per Kg.	12	10	8	
Total Purchase cost (₹)	36,600	3,49,170	2,56,264	6,42,034



**Illustration 6**

The following details apply to an annual budget for a manufacturing company.

QUARTER	1 <sup>st</sup>	2 <sup>nd</sup>	3 <sup>rd</sup>	4 <sup>th</sup>
Working Days	65	60	55	60
Production (Units per working day)	100	110	120	105
Raw material purchases (% by weight of annual total)	30%	50%	20%	—
Budgeted purchase price/Kg.( ₹)	1	1.05	1.125	—

Quantity of raw material per unit of production 2 kg. Budgeted closing stock of raw material 2,000 kg. Budgeted opening stock of raw material 4,000 kg. (Cost ₹ 4,000)

Issues are priced on FIFO Basis. Calculate the following budgeted figures.

- (a) Quarterly and annual purchase of raw material by weight and value.
- (b) Closing quarterly stocks by weight and value.

**Solution:**

**Material Purchase Budget**

Particulars	Quarter 1	Quarter 2	Quarter 3	Quarter 4	Total
Production	6,500	6,600	6,600	6,300	26,000
	(65x100)	(60x110)	(120x55)	(60x105)	
Material Required (Production x 2)	13,000	13,200	13,200	12,600	52,000
Add: Closing Stock					2,000
					54,000
Less: Opening Stock					4,000
Purchases by Weight	15,000	25,000	10,000	-	50,000

**Computation of Purchases by Value**

Particulars	Quarter 1	Quarter 2	Quarter 3	Quarter 4	Total
Purchases (Weight)	15,000	25,000	10,000	-	
	(50,000 x 30%)	(50,000 x 50%)	(50,000 x 20%)		
Cost per Kg.	1	1.05	1.125	-	
Purchases (₹)	15,000	26,250	11,250	-	52,500

**Budget Showing Closing Quarterly Stocks by Weight and Value**

Particulars	Quarter 1	Quarter 2	Quarter 3	Quarter 4
Opening Stock	4,000	6,000	17,800	14,600
Purchases	15,000	25,000	10,000	-
	19,000	31,000	27,800	14,600
Material consumed	13,000	13,200	13,200	12,600
Closing Stock by Weight	6,000	17,800	14,600	2,000
Closing Stock by Value (₹)	<b>6,000</b>	<b>18,690</b>	<b>16,080</b>	<b>2,250</b>
	(6,000 x 1)	(17,800 x 1.05)	{(10,000 x 1.125)+ (4,600 x 1.05)}	(2,000 x 1.125)

**Illustration 7**

You are required to prepare a Selling Overhead Budget from the estimates given below:

	Amount (₹)
Advertisement	1,000
Salaries of the Sales Dept.	1,000
Expenses of the Sales Dept. (Fixed)	750
Salesmen's remuneration	3,000
Salesmen's and Dearness Allowance - Commission @ 1% on sales affected	
Carriage Outwards: Estimated @ 5% on sales	
Agents Commission: 7½% on sales	

The sales during the period were estimated as follows:

- (a) ₹80,000 including Agent's Sales ₹8,000
- (b) ₹90,000 including Agent's Sales ₹10,000
- (c) ₹1,00,000 including Agent's Sales ₹10,500

**Solution:****Selling Overhead Budget**

(₹)

	80,000	90,000	1,00,000
Sales	80,000	90,000	1,00,000
(A) Fixed overhead:			
Advertisement	1,000	1,000	1,000
Salaries of the sales dept.	1,000	1,000	1,000
Expenses of the sales dept.	750	750	750
Salesmen remuneration	3,000	3,000	3,000
<b>Total (A)</b>	<b>5,750</b>	<b>5,750</b>	<b>5,750</b>
(B) Variable overhead:			
Commission	720 (72,000 x 1%)	800 (80,000 x 1%)	895 (89,500 x 1%)
Carriage outwards (5% on sales)	4,000	4,500	5,000
Agents Commission	600 (8,000 x 7.5%)	750 (10,000 x 7.5%)	788 (10,500 x 7.5%)
<b>Total (B)</b>	<b>5,320</b>	<b>6,050</b>	<b>6,683</b>
<b>Grand Total (A+B)</b>	<b>11,070</b>	<b>11,800</b>	<b>12,433</b>





**Illustration 8**

ABC Ltd. a newly started company wishes to prepare Cash Budget from January. Prepare a cash budget for the first six months from the following estimated revenue and expenses.

Amount (₹)

Month	Total Sales	Materials	Wages	Overheads	
				Production	Selling & Distribution
January	20,000	20,000	4,000	3,200	800
February	22,000	14,000	4,400	3,300	900
March	28,000	14,000	4,600	3,400	900
April	36,000	22,000	4,600	3,500	1,000
May	30,000	20,000	4,000	3,200	900
June	40,000	25,000	5,000	3,600	1,200

Cash balance on 1st January was ₹10,000. A new machinery is to be installed at ₹20,000 on credit, to be repaid by two equal installments in March and April, sales commission @5% on total sales is to be paid within a month following actual sales.

₹10,000 being the amount of 2nd call may be received in March. Share premium amounting to ₹2,000 is also obtained with the 2nd call. Period of credit allowed by suppliers — 2months; period of credit allowed to customers — 1month, delay in payment of overheads 1 month. Delay in payment of wages ½ month. Assume cash sales to be 50% of total sales.

**Solution:**

**Cash Budget for the First 6 Months**

Particulars	Jan	Feb	Mar	Apr	May	Jun
Opening Balance (A)	10,000	18,000	29,800	27,000	24,700	33,100
Add: Receipts (B)						
Cash Sales (50%)	10,000	11,000	14,000	18,000	15,000	20,000
Collection from debtors	-	10,000	11,000	14,000	18,000	15,000
Share call money (including share premium)	-	-	12,000	-	-	-
<b>Total (A+B)</b>	<b>20,000</b>	<b>39,000</b>	<b>66,800</b>	<b>59,000</b>	<b>57,700</b>	<b>68,100</b>
Less: Payments						
Materials	-	-	20,000	14,000	14,000	22,000
Wages	2,000	4,200	4,500	4,600	4,300	4,500
Overheads	-	4,000	4,200	4,300	4,500	4,100
Sales Commission	-	1,000	1,100	1,400	1,800	1,500
Installment of Machinery purchase	-	-	10000	10000	-	-
<b>Total Payments(C)</b>	<b>2,000</b>	<b>9,200</b>	<b>39,800</b>	<b>34,300</b>	<b>24,600</b>	<b>32,100</b>
<b>Closing Balance (A+B-C)</b>	<b>18,000</b>	<b>29,800</b>	<b>27,000</b>	<b>24,700</b>	<b>33,100</b>	<b>36,000</b>

**Note:** According to credit terms wages to be taken at half of the current month plus half of the previous month.

**Illustration 9**

Prepare a Cash Budget for the three months ending 30th June, 2016 from the information given below:

(a) Amount (₹)

MONTH	SALES	MATERIALS	WAGES	OVERHEADS
February	14,000	9,600	3,000	1,700
March	15,000	9,000	3,000	1,900
April	16,000	9,200	3,200	2,000
May	17,000	10,000	3,600	2,200
June	18,000	10,400	4,000	2,300

(b) Credit terms are:

Sales / Debtors : 10% sales are on cash, 50% of the credit sales are collected next month and the balance in the following month.

Creditors: Materials 2 months

Wages 1/4 month

Overheads 1/2 month.

(c) Cash and bank balance on 1st April, 2016 is expected to be ₹ 6,000.

(d) Other relevant information are:

- (i) Plant and machinery will be installed in February 2016 at a cost of ₹ 96,000. The monthly installment of ₹2,000 is payable from April onwards.
- (ii) Dividend @ 5% on preference share capital of ₹ 2,00,000 will be paid on 1st June.
- (iii) Advance to be received for sale of vehicles ₹ 9,000 in June.
- (iv) Dividends from investments amounting to ₹ 1,000 are expected to be received in June.

**Solution:**

**Cash Budget for the 3 Months Ending 30<sup>th</sup> June 2016**

**(Amount in ₹)**

Particulars	April	May	June
Opening Balance	6,000	3,950	3,000
Add: Receipts :			
Cash Sales	1,600	1,700	1,800
Collection from debtors [see note(1)]	13,050	13,950	14,850
Advance for sale of vehicles	-	-	9,000
Dividends from Investments	-	-	1,000
Total (A+B)	20,650	19,600	29,650
Less: Payments			
Materials	9,600	9,000	9,200
Wages (see note2)	3,150	3,500	3,900
Overheads	1,950	2,100	2,250
Installment of Plant & Machinery	2,000	2,000	2,000
Preference Dividend	-	-	10,000
Total (C)	16,700	16,600	27,350
Closing Balance (A+B-C)	3,950	3,000	2,300



**Working Notes:**

**(i) Computation of Collection from Debtors (Amount in ₹)**

Month	Total Sales	Credit Sales	Feb	Mar	Apr	May	June
Feb	14,000	12,600	-	6,300	6,300	-	-
Mar	15,000	13,500	-	-	6,750	6,750	-
Apr	16,000	14,400	-	-	-	7,200	7,200
May	17,000	15,300	-	-	-	-	7,650
					13,050	13,950	14,850

(ii) Wages payment in each month is to be taken as three-fourths of the current month plus one-fourth of the previous month.

**Illustration 10**

For production of 10,000 units the following are budgeted expenses:

	Amount (₹)
	Per Unit
Direct Materials	48
Direct Labour	24
Variable Overheads	20
Fixed Overheads (₹1,20,000)	12
Variable Expenses (Direct)	4
Selling Expenses (10% fixed)	12
Administration Expenses (₹40,000 fixed)	4
Distribution Expenses (20% fixed)	4
	128

Prepare a budget for production of 7,000 units and 9,000 units.

**Solution:**

**Flexible Budget**

Particulars	10000 Units		7000 Units		9000 Units	
	CPU	Total	CPU	Total	CPU	Total
A) Marginal Cost:						
Direct Material	48	4,80,000	48	3,36,000	48	4,32,000
Direct Labour	24	2,40,000	24	1,68,000	24	2,16,000
Variable Expenses	4	40,000	4	28,000	4	36,000
Variable overheads	20	2,00,000	20	1,40,000	20	1,80,000
Selling expenses (90% of ₹ 12)	10.80	1,08,000	10.80	75,600	10.80	97,200
Distribution expenses (80% of ₹ 4)	3.20	32,000	3.20	22,400	3.20	28,800
Total (A)	110.00	11,00,000	110.00	7,70,000	110.00	9,90,000



B) Fixed Cost:					
Fixed Overheads	12.00	1,20,000		1,20,000	1,20,000
Selling expenses	1.20	12,000		12,000	12,000
Administration overheads	4.00	40,000		40,000	40,000
Distribution expenses	0.80	8,000		8,000	8,000
Total (B)	18.00	1,80,000		1,80,000	1,80,000
Grand Total (A+B)	128.00	12,80,000		9,50,000	11,71,000

**Illustration 11**

Draw up a flexible budget for overhead expenses on the basis of the following data and determine the overhead rates at 70%, 80% and 90%

Amount (₹)

<b>Plant Capacity</b>	<b>At 80% capacity</b>
<b>Variable Overheads:</b>	
Indirect labour	12,000
Stores including spares	4,000
<b>Semi Variable:</b>	
Power (30% - Fixed: 70% -Variable)	20,000
Repairs (60%- Fixed: 40% -Variable)	2,000
<b>Fixed Overheads:</b>	
Depreciation	11,000
Insurance	3,000
Salaries	10,000
Total overheads	62,000
Estimated Direct Labour Hours	1,24,000

**Solution:**

**Flexible Budget at Different Capacities and Determination of Overhead Rates**

Amount (₹)

Particulars	70%	80%	90%
(A) Variable Overheads:			
Indirect labour	10,500	12,000	13,500
Stores including spares	3,500	4,000	4,500
Total (A)	14,000	16,000	18,000
(B) Semi Variable Overheads:			
Power (See Note)	18,250	20,000	21,750
Repairs (See Note)	1,900	2,000	2,100
Total (B)	20,150	22,000	23,850
(C) Fixed Overheads:			
Depreciation	11,000	11,000	11,000
Insurance	3,000	3,000	3,000
Salaries	10,000	10,000	10,000
Total (C)	24,000	24,000	24,000
Grand Total (A+B+C)	58,150	62,000	65,850



Labour Hours	10,8,500 $\left(1,24,000 \times \frac{7}{8}\right)$	1,24,000	1,39,500 $\left(1,24,000 \times \frac{9}{8}\right)$
Overhead rate per hour (₹)	= 0.536 $\left(\frac{58,150}{1,08,500}\right)$	= 0.50 $\left(\frac{62,000}{1,24,000}\right)$	= 0.472 $\left(\frac{65,850}{1,39,500}\right)$

**Working Notes:**

**Semi Variable Overheads**

	70%	90%
Power:		
Variable	$\left(14,000 \times \frac{7}{8}\right) = 12,250$	$\left(14,000 \times \frac{9}{8}\right) = 15,750$
Fixed	<u>6,000</u>	<u>6,000</u>
Total	18,250	21,750
Repairs:		
Variable	$\left(800 \times \frac{7}{8}\right) = 700$	$\left(800 \times \frac{9}{8}\right) = 900$
Fixed	1,200	1,200
Total	1 900	2 100

**Illustration 12**

From the following information relating to 2014 and conditions expected to prevail in 2015, prepare a budget for 2015.

	Amount (₹)
<b>2014 Actual:</b>	
Sales (40,000 units)	1,00,000
Raw materials	53,000
Wages	11,000
Variable Overhead	16,000
Fixed Overheads	10,000
<b>2015 Prospects:</b>	
Sales (60,000 units)	1,50,000
Raw Materials	5% increase in prices
Wages	10% increase in wage rate
	5% increase in productivity
Additional plant:	One Lathe ₹ 25,000
	One Drill ₹12,000
10% Depreciation to be considered.	

**Solution:****Budget Showing Costs and Profits for the Year 2015**

<b>I. Sales</b>	1,50,000
<b>II. Costs:</b>	
Raw Materials $\left(53,000 \times \frac{6}{4} \times \frac{105}{100}\right)$	83,475
Wages $\left(11,000 \times \frac{110}{100} \times \frac{6}{4} \times \frac{100}{105}\right)$	17,285
Variable Overheads $\left(16,000 \times \frac{6}{4}\right)$	24,000
Fixed Overheads $\left[10,000 \left(3,70,000 \times \frac{10}{100}\right)\right]$	13,700
	1,38,460
<b>iii. Profit (i – ii)</b>	<b>11,540</b>

**Illustration 13**

Production costs of a factory for a year are as follows:

	Amount (₹)
Direct Wages	80,000
Direct Materials	1,20,000
Production Overheads: Fixed	40,000
Variable	60,000

During the forthcoming year it is anticipated that:

- The average rate for direct labour remuneration will fall from ₹0.80 per hour to ₹0.75 per hour.
- Production efficiency will be reduced by 5%
- Price per unit of direct material and of other materials and services which comprise overheads will remain unchanged, and
- Production in the coming year will increase by  $33\frac{1}{3}\%$ . Draw up a production cost budget.

**Solution:****Production Cost Budget for the Forthcoming Year**

Particulars	Amount (₹)
i. Wages $\left[80,000 \times 133\frac{1}{3}\% \left(\frac{0.75}{0.80}\right) \times \frac{100}{95}\right]$	1,05,263
ii. Materials $\left[1,20,000 \times 133\frac{1}{3}\%\right]$	1,60,000
iii. Variable Overheads $\left[60,000 \times 133\frac{1}{3}\%\right]$	80,000
iv. Fixed Overheads	40,000
Production cost	3,85,263



**Illustration 14**

A company manufactures two products, A and B and the budgeted data for the year are as follows:

Amount (₹)

	Product A	Product B
Sales price per unit	100	75
Direct material per unit	20	10
Direct wages per unit	5	4
Total works overhead	10,105	9,009
Total marketing overhead	1,200	1,100

The sales manager forecasts the sales in units as follows:

	Product A (units)	Product B (units)
January	28	10
February	28	12
March	24	16
April	20	20
May	16	24
June	16	24
July to January (next year) Per month	18	20

It is assumed that (i) there will be no work in progress at the end of any month, and (ii) finished units equal to half the sales for the following month will be kept in stock.

Prepare (a) A Production Budget for each month and (b) A Summarized Profit and Loss Statement for the year.

**Solution:**

**(a) Production Budget (in number of units)**

	JAN	FEB	MAR	APR	MAY	JUN	JUL	AUG	SEP	OCT	NOV	DEC	TOTAL
Product –A													
Sales	28	28	24	20	16	16	18	18	18	18	18	18	240
Add: Closing Stock	14	12	10	8	8	9	9	9	9	9	9	9	
	42	40	34	28	24	25	27	27	27	27	27	27	
Less: Opening Stock	14	14	12	10	8	8	9	9	9	9	9	9	
Production	28	26	22	18	16	17	18	18	18	18	18	18	235
Product- B													
Sales	10	12	16	20	24	24	20	20	20	20	20	20	226
Add: Closing Stock	6	8	10	12	12	10	10	10	10	10	10	10	
	16	20	26	32	36	34	30	30	30	30	30	30	
Less: Opening Stock	5	6	8	10	12	12	10	10	10	10	10	10	
Production	11	14	18	22	24	22	20	20	20	20	20	20	231



(b)

**Summarised Product Cost Budget**

Amount (₹)

Output Particulars	Product A 235 units	Product B 231 units	Total
Direct Material : A @ ₹ 20	4,700		
B @ ₹ 10		2310	7,010
Direct Labour : A @ ₹ 5	1,175		
B @ ₹ 4		924	2,099
Works overheads	10,105	9009	19,114
Total production Cost	15,980	12,243	28,223
Cost per unit	68	53	
	(15,980/235)	(12,243/231)	

**Summarised Profit and Loss Statement for the Year**

Amount (₹)

Particulars	Product A	Product B	Total
Sales	24,000	16,950	40,950
Less:	16,320	11,978	
Production Cost of goods sold (240 x 68)	1,200	1,100	
(226 x 53)			
Marketing Overheads			
Total (ii) Cost (ii)	17,520	13,078	30,598
Profit (i - ii)	6,480	3,872	10,352

**Illustration 15**

Three Articles X, Y and Z are produced in a factory. They pass through two cost centers A and B. From the data furnished compile a statement for budgeted machine utilization in both the centers.

(a) Sales budget for the year

Product	Annual Budgeted Sales (units)	Opening stock of finished products (units)	Closing stock
X	4800	600	Equivalent to 2 months sales
Y	2400	300	--DO--
Z	2400	800	--DO--

(b) Machine hours per unit of product

Product	Cost centers	
	A	B
X	30	70
Y	200	100
Z	30	20





(c) Total number of machines

Cost Centre:	A	284
	B	256
Total		540

(d) Total working hours during the year: Estimated 2500 hours per machine.

**Solution:**

**Calculation of Units of Production of Different Products**

Particulars	Product X	Product Y	Product Z
Sales	4800	2400	2400
Add: Closing Stock	800	400	400
	5600	2800	2800
Less: Opening stock	600	300	800
Production	5000	2500	2000

**MACHINE UTILISATION BUDGET**

Particulars	A				B			
	X	Y	Z	Total	X	Y	Z	Total
(i) Production (Units)	5000	2500	2000		5000	2500	2000	
(ii) Hours per unit	30	200	30		70	100	20	
(iii) Total Machine Hours	1,50,000	5,00,000	60,000	7,10,000	3,50,000	2,50,000	40,000	6,40,000
(iv) Number of Machines Required	60	200	24	284	140	100	16	256

**Illustration 16**

The monthly budgets for manufacturing overhead of a concern for two levels of activity were as follows:  
Amount (₹)

Capacity	60%	100%
Budgeted production (units)	600	1,000
Wages	1,200	2,000
Consumable stores	900	1,500
Maintenance	1,100	1,500
Power and fuel	1,600	2,000
Depreciation	4,000	4,000
Insurance	1,000	1,000
	9,800	12,000

**You are required to:**

- (i) Indicate which of the items are fixed, variable and semi-variable;
- (ii) Prepare a budget for 80% capacity and
- (iii) Find the total cost, both fixed and variable per unit of output at 60%, 80% and 100% capacity.



**Solution:**

- (i) Fixed → Depreciation and insurance.
- Variable → Wages and consumables stores.
- Semi-variable Costs → Maintenance, Power and fuel.

Seggregation Of Semi Variable Costs

$$\text{Maintenance} = \left( \frac{1,500 - 1,100}{400} \right) = ₹ 1 \text{ per unit variable and } ₹500 \text{ fixed (i.e., } 1,100-600)$$

$$\text{Power and fuel} = \left( \frac{2,000 - 1,600}{400} \right) = ₹ 1 \text{ per unit variable and } ₹1000 \text{ (i.e., } 1,600-600) \text{ is fixed.}$$

- (ii) Budget for 80% capacity(output 800 units):

	Amount (₹)
Wages @₹2 per unit	1,600
Consumables stores @ ₹ 1.50 per unit	1,200
Maintenance: ₹ 500 + ₹ 1.00 per unit	1,300
Power & fuel ₹ 1,000 + ₹1 per unit	1,800
Depreciation	4,000
Insurance	1,000
<b>Total cost:</b>	<b>10,900</b>

- (iii)

Capacity Units	60%		80%		100%	
	600		800		1000	
	Total (₹)	Per unit	Total (₹)	Per unit	Total (₹)	Per unit
Fixed Costs:						
Depreciation	4,000		4,000		4,000	
Insurance	1,000		1,000		1,000	
Maintenance	500		500		500	
Power and fuel	1,000		1,000		1,000	
	6,500	10.83	6,500	8.125	6,500	6.50
Variable costs:						
Wages @ ₹2perunit	1,200		1,600		2,000	
Consumable stores @ ₹ 1.50 per unit	900		1,200		1,500	
Maintenance @ ₹ 1 Per unit	600		800		1,000	
Power and fuel @ ₹ 1 per unit	600		800		1,000	
	3,300	5.50	4,400	5.500	5,500	5.50
		16.33		13.625		12.00



## GLOSSARY

**Budget:** The Terminology (CIMA-London) defines a Budget as a plan quantified in monetary terms, prepared and approved prior to a defined period of time, usually showing planned income to be generated and / or expenditure to be incurred during that period and the capital to be employed to attain a given objective.

**Budget Centre:** A Budget Centre is a section of an organisation developed for the purpose of budgetary control, and is intended to facilitate formulation of various budgets with the help of head of the department.

**Budget Manual:** Budget Manual is a document which contains standing instructions regarding the procedures to be followed at the time of budget preparation.

**Budget Period:** Budget Period is the period for which a budget is prepared and used. It usually covers one year.

**Budgetary Control:** As per CIMA-London Terminology Budgetary Control is the establishment of budgets, relating the responsibilities of executives to the requirements of a policy, and the continuous comparison of actual with budgeted results, either to secure by individual action the objective of that policy or to provide a basis for its revision.

**Budgeted Cost:** Budgeted Cost is an expected cost for the total activity.

**Capital Budget:** Capital Budget is a budget prepared for capital receipts and expenditure such as obtaining loans, issue of shares, purchase of assets etc.

**Cash Budget:** Cash Budget is a detailed budget of cash income and cash expenditure incorporating both revenue and capital items for the budget period.

**Fixed Budget:** Fixed Budget is the budget designed to remain unchanged irrespective of the level of activity actually attained.

**Flexible Budget:** Flexible Budget is the budget which, by recognising the difference in behaviour between fixed and variable costs in relation to fluctuations in output, turnover, or other variable factors, is designed to change appropriately with such fluctuations.

**Functional Budget:** Functional Budget is the budget prepared for a certain period covering each and every function of the organisation separately.

**Long Term Budget:** Long Term Budget is a budget prepared covering a period of more than a year.

**Master Budget:** Master Budget is a budget which is prepared from the functional budgets in summary form. When all functional budgets are prepared, they are summarised to produce budgeted profit & loss account and budgeted balance sheet.

**Materials Budget:** Materials Budget is the budget that includes quantities of direct materials needed for the finished product in the budget period of an organisation.

**Performance Budgeting:** Performance Budgeting means that the responsibility of various levels of management is predetermined in terms of output or result keeping in view the authority vested with them.

**Principal Budget Factor:** The Terminology (CIMA-London) defines Principal Budget Factor or Key Factor or Limiting Factor as a factor which at a particular time or over a period will limit the activities of an organisation and which is therefore, taken into account in preparing budgets.

**Production Budget:** Production Budget is a forecast of the production for the budget period of an organisation.



**Purchase Budget:** Purchase Budget is the budget that establishes the quantity and value of the various items of materials to be purchased for delivery at specified point of time during the budget period taking into account the production schedule and the inventory requirements of the organisation.

**Responsibility Accounting:** Responsibility Accounting is the system of accounting that segregates revenues and costs into areas of personal responsibility in order to assess the performance attained by persons to whom authority has been assigned.

**Revenue Budget:** Revenue Budget is a budget covering revenue receipts and expenses for a certain period, such as, sales, purchases, administrative expenses etc.

**Sales Budget:** Sales Budget is the quantitative and financial statement of sales, prepared prior to a defined period of time, to be achieved during that period.

**Short Term Budget:** Short Term Budget is a budget prepared for a period covering a year or less than a year.

**Zero-based Budgeting:** Zero-based Budgeting is defined as a method of budgeting which requires each cost element to be specifically justified, though the activities to which the budget relates are being undertaken for the first time, without approval, the budget allowance is zero.

### Theoretical Questions

1. Explain the advantages and disadvantages of Budget and Budgetary Control.
2. Distinguish between Fixed and Flexible Budget
3. What is Flexible Budget? Discuss the characteristics of Flexible of Budget.
4. Write short notes on:
  - (a) Master Budget
  - (b) Performance Budgeting
  - (c) Responsibility Accounting
  - (d) Zero based Budgeting

### MULTIPLE CHOICE QUESTIONS:

1. Budgets are shown in \_\_\_\_ Terms
  - A. Qualitative
  - B. Quantitative
  - C. Materialistic
  - D. both (b) and (c)
2. Which of the following is not an element of master budget?
  - A. Capital Expenditure Budget
  - B. Production Schedule
  - C. Operating Expenses Budget
  - D. All above



3. Which of the following is not a potential benefit of using a budget?
  - A. Enhanced coordination of firm activities
  - B. More motivated managers
  - C. Improved interdepartmental communication
  - D. More accurate external financial statements
  
4. Which of the following is a long-term budget?
  - A. Master Budget
  - B. Flexible Budget
  - C. Cash Budget
  - D. Capital Budget
  
5. Materials become key factor, if
  - A. quota restrictions exist
  - B. insufficient advertisement prevails
  - C. there is low demand
  - D. there is no problem with supplies of materials
  
6. The difference between fixed cost and variable cost assumes significance in the preparation of the following budget.
  - A. Master Budget
  - B. Flexible Budget
  - C. Cash Budget
  - D. Capital Budget
  
7. The budget that is prepared first of all is ...
  - A. Master budget
  - B. Budget, with key factor
  - C. Cash Budget
  - D. Capital expenditure budget
  
8. Sales budget is a \_\_\_\_
  - A. expenditure budget
  - B. functional budget
  - C. Master budget
  - D. None of these



9. When a company wants to prepare a factory overhead budget in which the estimated costs are directly derived from the estimates of activity levels, which of the following budget should be prepared by the company?
- A. Flexible budget
  - B. Fixed budget
  - C. Master budget
  - D. R & D budget
  - E. None of the above
10. Which of the following budgets facilitates classification of fixed and variable costs:
- A. Capital expenditure budget
  - B. Flexible budget
  - C. Cash budget
  - D. Raw materials budget
  - E. All of the above
11. The entire budget organisation is controlled and headed by a senior executive known as:
- A. General Manager
  - B. Accountant
  - C. Budget Controller
  - D. None of the above
12. Which of the following is generally a long term budget?
- A. Cash budget
  - B. Sales budget
  - C. Research and Development budget
  - D. Capital expenditure budget
  - E. None of the above
13. A flexible budget requires a careful study of
- A. Fixed, semi-fixed and variable expenses
  - B. Past and current expenses
  - C. Overheads, selling and administrative expenses.
  - D. None of these.
14. The basic difference between a fixed budget and flexible budget is that a fixed budget \_\_\_\_\_
- A. is concerned with a single level of activity, while flexible budget is prepared for different levels of activity
  - B. Is concerned with fixed costs, while flexible budget is concerned with variable costs.
  - C. is fixed while flexible budget changes
  - D. None of these.

[Ans: D, B, D, D, A, B, B, B, A, B, C, D, A,A]



**States whether the statements are True or False:**

1. Budget is a means and budgetary control is the end result.
2. To achieve the anticipated targets, Planning, Co-ordination and Control are the important main tasks of management, achieved through budgeting and budgetary control.
3. A key factor or principal factor does not influence the preparation of all other budgets.
4. Budgetary control does not facilitate introduction of 'Management by Exception'.
5. Generally, budgets are prepared to coincide with the financial year so that comparison of the actual performance with budgeted estimates would facilitate better interpretation and understanding.
6. A flexible budget is one, which changes from year to year.
7. A flexible budget recognises the difference between fixed, semi-fixed and variable cost and is designed to change in relation to the change in level of activity
8. Sales budget, normally, is the most important budget among all budgets.
9. The principal factor is the starting point for the preparation of various budgets.
10. A budget manual is the summary of all functional budgets.

[Ans. 1. True 2. True 3. False 4. False 5. True 6. False 7. True 8. True 9. True 10. False.]

**Fill in the Blanks:**

1. Budgets are \_\_\_\_\_ plans.
2. The key factor in a budget does not remain the \_\_\_\_\_ every year.
3. Cash budget is a part of \_\_\_\_\_ budget.
4. \_\_\_\_\_ budgets are subsidiary to master master budget.
5. \_\_\_\_\_ leads to budgeting and budgeting leads to budgetary control.
6. \_\_\_\_\_ Control involves checking and evaluation of actual performance.
7. The document which describes the budgeting organisation, procedure etc is known as \_\_\_\_\_.
8. A budget is a \_\_\_\_\_ to management.
9. The principle budget factor for consumer goods manufacture is normally \_\_\_\_\_.
10. A budget is a projected plan of action in \_\_\_\_\_.

[Ans. Action, Same, Financial, Functional, Forecasting, Budgetary, Budget manual, Aid, Sales Demand, Physical units & monetary terms]

**Match the following:**

	<b>Column A</b>		<b>Column B</b>
1.	Master budget denotes the summary of	A	Financial means.
2.	A flexible budget takes into the account.	B	A specified period.
3.	A budget is expressed in terms of.	C	Flexible Budget
4.	Which budget is prepared for a longer period.	D	Master Budget
5.	Budget is generally prepared for how long.	E	Fixed, variable and semi variable costs.
6.	Which budget is prepared for more than one level of activity	F	Functional Budget
7.	The summary of all functional budgets.	G	Principle Key factor
8.	Which budget is prepared at first.	H	Capital Expenditure Budget
9.	Which budget shows utilisation of liquid cash	I	Decision Package
10.	Zero based budgeting	J	Cash Budget

[Ans: F, E, A, H, B, C, D, G, J, I]





## INTERMEDIATE EXAMINATION

June 2019

**P-8 (CAC)**  
**Syllabus 2016**

### Cost Accounting

Time Allowed: 3 Hours

Full Marks: 100

*The figures in the margin on the right side indicate the full marks.*

*All Sections are compulsory. Each section contains instructions regarding the number of questions to be answered within the section.*

*All working notes must form part of the answer.*

*Wherever necessary, candidates may make appropriate assumptions and clearly state them.*

*No present value factor table or other statistical table will be provided in addition to this question paper.*

#### Section-A

Section A contains Question Number 1. All parts of this question are compulsory.

1. Answer the following questions:

(a) **Choose the correct answer from the given alternatives (You may write only the Roman numeral and the alphabet chosen for your answer):** 1x10=10

- (i) The main purpose of Cost Accounting is
- (A) to maximise profit.
  - (B) to help in inventory valuation.
  - (C) to help in the fixation of selling price.
  - (D) to provide information to management for decision making.
- (ii) Which of the following is considered to be a normal loss of material?
- (A) Loss due to accident
  - (B) Pilferage
  - (C) Loss due to breaking the bulk
  - (D) Loss due to careless handling of material



- (iii) In Reconciliation Statement expenses shown only in financial accounts are
- (A) added to financial profit.
  - (B) added to costing profit.
  - (C) ignored.
  - (D) deducted from financial profit.
- (iv) Which of the following is a service department?
- (A) Refining department
  - (B) Machining department
  - (C) Receiving department
  - (D) Finishing department
- (v) Which of the following items is not included in preparation of cost sheet?
- (A) Purchase returns
  - (B) Carriage inwards
  - (C) Sales commission
  - (D) Interest paid
- (vi) In job costing to record the issue of direct materials to a job which of the following document is used?
- (A) Purchase order
  - (B) Goods receipt note
  - (C) Material requisition
  - (D) Purchase requisition
- (vii) In a process 4000 units are introduced during a period. 5% of input is normal loss. Closing work-in-progress 60% complete is 500 units. 3300 completed units are transferred to next process. Equivalent production for the period is
- (A) 3550 units
  - (B) 3600 units
  - (C) 3800 units
  - (D) 3950 units
- (viii) Product A generates a contribution to sales ratio of 40%. Fixed cost directly attributable to A amount ₹ 60,000. The sales revenue required to achieve a profit of ₹ 15,000 is
- (A) ₹ 2,00,000
  - (B) ₹ 1,85,000
  - (C) ₹ 1,87,500
  - (D) ₹ 2,10,000



- (ix) During a period 13600 labour hours were worked at a standard rate of ₹ 8 per hour. The direct labour efficiency variance was ₹ 8,800 (Adv). How many standard hours were produced?
- (A) 12000 hours  
 (B) 12500 hours  
 (C) 13000 hours  
 (D) 13500 hours
- (x) Cash Budget of ABC Ltd. forewarns of a short-term surplus. Which of the following would be appropriate action to be taken in such a situation?
- (A) Purchase new fixed assets  
 (B) Repay long-term loans  
 (C) Write off preliminary expenses  
 (D) Pay creditors early to obtain a cash discount

(b) **Match the statement in Column I with the most appropriate statement in Column II**

(You may opt to write only the Roman numeral and the matched alphabet instead of copying contents into the answer books): 1x5=5

	Column I		Column II
(i)	Pharma Industry	(A)	Opportunity Cost
(ii)	Management by exception	(B)	Direct Allocation
(iii)	Assessment of employee with respect to a job	(C)	Joint Cost
(iv)	Royalties	(D)	Batch Costing
(v)	CAS-19	(E)	Merit Rating
		(F)	Variance Analysis
		(G)	Job Evaluation
		(H)	Notional Cost

(c) **State whether the following are 'True' or 'False':** (You may write only the Roman numeral and whether 'True' or 'False' without copying the statements into the answer books): 1 x5=5

- (i) Bin card is maintained by the costing department.  
 (ii) CAS-8 deal with the principles and methods of determining the direct expenses.  
 (iii) FIFO method is followed for evaluation of equivalent production when prices are fluctuating.  
 (iv) Profit Volume ratio remains constant at all levels of activity.  
 (v) The principal factor is the starting point for the preparation of various budgets.

(d) **Fill in the blanks:** (You may write only the Roman numeral and the content filling the blanks): 1x5=5

- (i) Differential cost is the change in the cost due to change in \_\_\_\_\_ from one level to another.  
 (ii) CAS \_\_\_\_\_ stands for cost of service cost centre.  
 (iii) In contract costing, the cost unit is \_\_\_\_\_ .  
 (iv) Marginal cost is the \_\_\_\_\_ of sales over contribution.  
 (v) When actual cost is less than the standard cost, it is known as \_\_\_\_\_ variance.

**Section - B***Answer any five questions from question numbers 2 to 8.**Each question carries 15 marks.*

15x5=75

2. (a) ZINTES LTD. a manufacturing company has its factories at two locations. Rowan plan is in use at location A and Halsey plan at location B. Standard time and basic rate of wages are same for a job which is similar and is carried out on similar machinery. Time allowed is 60 hours.

Job at location A is completed in 36 hours while at B, it has taken 48 hours. Conversion costs at respective places are ₹ 1224 and ₹ 1500. Overheads amount to ₹ 20 per hour.

Required:

- (i) Find out the normal wage rate, and  
(ii) Compare conversion costs.

7

- (b) ALPHA LTD. has three Production Departments and two Service Departments. The overhead distribution sheet of the company showed the following totals:

Production Department:	Amount (₹)
P	75,500
Q	72,000
R	96,500
Service Department:	
X	46,250
Y	15,750

Other information is as follows:

- (a) Working hours of production departments are P-6226 hours, Q-4028 hours and R-4066 hours.  
(b) Services rendered by service departments are as under:

	P	Q	R	X	Y
Department X	20%	30%	40%	—	10%
Department Y	40%	20%	30%	10%	—

Required:

- (i) Calculate the total overhead of production departments distributing the cost of service departments by **Simultaneous Equation Method**.  
(ii) Calculate the overhead rate per hour of production departments.

8

3. (a) What is the Employee Cost as defined in CAS-7 (Limited Revision 2017)? Also discuss the general principles of its measurement as per CAS-7. (*any five only*)

6

- (b) The following information has been extracted from the financial books of ABC Ltd. for the year ended 31st March, 2019:



<b>Particulars</b>	<b>Amount (₹)</b>
Direct materials consumption	10,00,000
Direct wages	6,00,000
Factory Overhead	3,20,000
Administrative Overhead	1,40,000
Selling and Distribution Overhead	1,92,000
Bad debts	16,000
Preliminary expenses written-off	8,000
Legal expenses	2,000
Dividend received	20,000
Interest on deposits received	4,000
Sales(24000 units)	24,00,000
Closing stock of finished goods (800 units)	64,000
Closing stock of work-in-progress	48,000

The cost accounts for the same period reveal that the direct materials consumption was ₹11,20,000. Factory overheads recovered at 20% of prime cost; Administration overheads recovered @ ₹ 6 per unit of production; and selling and distribution overheads recovered at ₹ 8 per unit sold.

*Required:*

- Find out the profit as per financial books.
- Prepare the cost sheet and ascertain the profit per cost accounts.
- Prepare a statement reconciling profit shown by financial and cost accounts.

9

4. (a) VIPUL LTD. submits the following information on 31st March, 2019:

<b>Particulars</b>	<b>Amount (₹)</b>
Sales for the year	55,00,000
Purchases of material for the year	22,00,000
Direct labour	13,00,000
Inventories at the beginning of the year—	
Finished goods	1,40,000
Work-in-progress	80,000
Materials inventory—	
At the beginning of the year	60,000
At the end of the year	80,000
Inventories at the end of the year—	
Work-in-progress	1,20,000
Finished goods	1,60,000



Factory overheads were 60% of the direct labour cost.

Administration expenses were 5% of sales.

Selling & distribution expenses were 10% of sales.

You are required to prepare a **Cost Sheet** with all elements.

8

- (b) WEST LAND LTD. in the course of refining crude oil obtains four joint products P, Q, R and S. The total cost till the split-off point was ₹ 9,76,640. The output and sales in the year 2018 were as follows:

Product	Output (Gallon)	Sales Amount (₹)	Separate Costs Amount (₹)
P	50,000	12,50,000	2,60,000
Q	10,000	30,000	20,000
R	5,000	50,000	—
S	8,000	80,000	10,000

Required:

- Calculate the net income for each of the products if the joint costs are apportioned on the basis of Net realisable values (NRV) of the different products.
- Calculate the net income of each of the products if the company decides to sell the products at the split-off point itself as-P@ ₹18, Q @ ₹1.50, R @ ₹10 and S @ ₹7.80 per gallon.

7

5. (a) CARLHAMS LTD. runs a lodging home in a hill station. For this purpose, it has hired a building at a rent of ₹1,20,000 per month along with 5% of total takings. The lodging home has three types of suites for its customers, viz., single room, double rooms and triple rooms.

Following information is given:

Type of Suite	Number	Occupancy %
Single Room	100	80%
Double Rooms	40	60%
Triple Rooms	20	50%

The rent of double rooms suite is to be fixed at 1.5 times of the single room suite and that of triple rooms suite as twice of the double rooms suite.

The expenses for the year 2018 are as follows:

Particulars	Amount (₹)
Staff salaries	32,50,000
Room attendants' wages	12,00,000
Lighting, heating and power	9,75,000
Repairs & renovation	4,80,000
Laundry charges	1,65,000
Interior decoration	1,80,000
Sundry expenses	1,94,000

Provide profit @ 20% on total takings and assume 360 days in a year.

You are required to **work out the room rent chargeable** per day for each type of suite.

8



- (b) NIRVANA LTD. undertook a contract for ₹50,00,000 on 1st April, 2018. On 31st March, 2019 when the accounts of the company were closed, the following details about the contract were gathered:

Particulars	Amount (₹)
Materials purchased	10,00,000
Wages paid	4,50,000
General expenses	1,00,000
Plant purchased	5,00,000
Materials on hand on 31.03.2019	2,50,000
Wages accrued on 31.03.2019	50,000
Work certified	20,00,000
Cash received	15,00,000
Work uncertified	1,50,000
Depreciation of plant	50,000

The above contract contained an escalation clause which read as follows:

"In the event of prices of materials and rates of wages increase by more than 5%, the contract price would be increased accordingly by 25% of the rise in the cost of materials and wages beyond 5% in each case."

It was found that since the date of signing the agreement, the price of materials and wage rates increased by 25%. The value of work certified does not take into account the effect of the above clause.

Required:

Prepare Contract Account of the company as on 31st March, 2019.

7

6. (a) MODERN LTD. has three departments X, Y and Z, each of which makes a different product. The budgeted data for the coming year are as follows:

Particulars	Amount (₹)		
	X	Y	Z
Sales	22,40,000	11,20,000	16,80,000
Direct materials	2,80,000	1,40,000	2,80,000
Direct labour	1,12,000	1,40,000	4,48,000
Direct expenses	2,80,000	1,40,000	5,60,000
Fixed cost	5,60,000	2,80,000	5,60,000

The management of the company is considering to close down department 'Z'. There is a possibility of reducing fixed cost by ₹1,50,000 if department 'Z' is closed down.

**Advise the management** whether or not department 'Z' should be closed down.

8

- (b) SRIJAN LTD. had incurred fixed expenses of ₹9,00,000 with sales of ₹20,00,000 and earned a profit of ₹3,00,000 during the first half-year. In the second-half, it suffered a loss of ₹1,50,000.

Required:

Calculate the following:

- The P/V Ratio, Break Even Point and Margin of Safety for the first half-year.
- The expected sales amount for the second half-year assuming that the selling price and fixed expenses remained unchanged during the second half-year.
- The Break Even point and Margin of Safety for the whole year.

7



7. (a) BENCO LTD. a manufacturing concern which has adopted standard costing furnishes the following information for the month ending March 31, 2019:

The standard mix to produce one unit of product Z is as under—

Material A	30kg @ ₹ 30 per kg
Material B	40kg @ ₹ 50 per kg
Material C	50kg @ ₹ 40 per kg

During the month of December 2018, 10 units of product Z were actually produced and consumption was as under—

Material A	320kg @ ₹ 35 per kg
Material B	475kg @ ₹ 55 per kg
Material C	435kg @ ₹ 36 per kg

Required:

Calculate the following Material Variances:

- Material Cost Variance
- Material Price Variance
- Material Usage Variance
- Material Mix Variance
- Material Yield Variance

8

- (b) ANKRITI LTD. manufactures product X and product Y during the year ending on 31st March, 2019. It is expected to sell 7500 kg of product X and 37500 kg of product Y @ ₹ 60 and ₹ 32 per kg respectively.

The direct materials A, B and C are mixed in the proportion of 4:4:2 in the manufacture of Product X and in the proportion of 3:5:2 in the manufacture of product Y. The actual and budget inventories for the year are as follows:

Particulars	Opening Stock (kg)	Expected Closing Stock (kg)	Anticipated Cost per kg (₹)
Material A	3000	2400	10
Material B	2500	5800	8
Material C	16000	17300	6
Product X	1500	2000	—
Product Y	3000	3500	—

Required:

Prepare the Production Budget and Materials Budget showing the purchase cost of materials for the year ending 31 st March, 2019.

7

8. Answer any three out of the following four questions:

5x3=15

- Distinguish between Cost Allocation and Cost Apportionment.
- State the main objectives of Cost Accounting.
- List out the various measures to reduce the Labour Turnover (*any five*).
- Write a brief note on Master Budget.





## INTERMEDIATE EXAMINATION

December 2018

**P-8 (CAC)**  
**Syllabus 2016**

### Cost Accounting

Time Allowed: 3 Hours

Full Marks: 100

*The figures in the margin on the right side indicate the full marks.*

*All Sections are compulsory. Each section contains instructions regarding the number of questions to be answered within the section.*

*All working notes must form part of the answer.*

*Wherever necessary, candidates may make appropriate assumptions and clearly state them.*

*No present value factor table or other statistical table will be provided in addition to this question paper.*

#### Section-A

***Section A contains Question Number 1. All parts of this question are compulsory.***

**1. Answer the following questions:**

- (a) **Choose the correct answer from the given alternatives** (You may write only the Roman numeral and the alphabet chosen for your answer): 1x10=10
- (i) Joint Cost is suitable for
- (a) Oil Industry
  - (b) Fertilizer Industry
  - (c) Ornament Industry
  - (d) Infrastructure Industry
- (ii) Cost of idle time arising due to non-availability of raw materials is
- (a) recovered by inflating the raw materials cost.
  - (b) recovered by inflating the wage rate.
  - (c) charged to factory overheads.
  - (d) charged to costing profit and loss account.
- (iii) Charging to a cost center those overheads that result solely for the existence of that cost center is known as
- (a) Allotment
  - (b) Allocation
  - (c) Absorption
  - (d) Apportionment



- (iv) Standard deals with the cost of service cost center is
- (a) CAS-9
  - (b) CAS- 13
  - (c) CAS-16
  - (d) CAS-22
- (v) In Reconciliation Statement income shown only in financial accounts is
- (a) added to financial profit.
  - (b) deducted from financial profit.
  - (c) ignored.
  - (d) deducted from costing profit.
- (vi) The most suitable cost system where the products differ in type of material and work performed is
- (a) Process Costing
  - (b) Batch Costing
  - (c) Job Costing
  - (d) Operating Costing
- (vii) In a process 10000 units are introduced during a period. 10% of input is normal loss. Closing work-in-process 70% complete is 1500 units. 7500 completed units are transferred to next process. Equivalent production for the period is
- (a) 9550 units
  - (b) 9000 units
  - (c) 8550 units
  - (d) 8500 units
- (viii) The sales and profit of a firm for the year 2016 are ₹ 1,50,000 and ₹ 20,000 and for the year 2017 are ₹ 1,70,000 and ₹ 25,000 respectively. The P/V Ratio of the firm
- (a) 15%
  - (b) 20%
  - (c) 25%
  - (d) 30%
- (ix) Standard quantity of material for one unit output is 10 kg @ ₹ 8 per kg. Actual output during a given period is 600 units. The standard quantity of material for actual output is
- (a) 1200 kg
  - (b) 6000 kg
  - (c) 4800 kg
  - (d) 48000 kg
- (x) Which of the following is a long-term Budget?
- (a) Master Budget
  - (b) Production Budget
  - (c) Flexible Budget
  - (d) Capital Budget

(b) **Match the statement in Column I with the most appropriate statement in Column II**

(You may opt to write only the Roman numeral and the matched alphabet instead of copying contents into the Answer Books):

1 x5=5

	Column I		Column II
(i)	Cash discount allowed	(A)	Joint Cost
(ii)	Escalation Clause	(B)	Imputed Cost
(iii)	CAS-19	(C)	Direct Expenses
(iv)	Notional Cost	(D)	Not shown in cost sheet but debited to profit and loss account
(v)	Zero base budgeting	(E)	Sunk Cost
		(F)	Contract Costing
		(G)	Decision Package
		(H)	Variable Cost

(c) **State whether the following statements are 'True' or 'False'** (You may write only the Roman numeral and whether True' or 'False' without copying the statements into the Answer Book):

1x5=5

- (i) Multiple costing is suitable for banking industry.
- (ii) Slow moving materials have a high turnover ratio.
- (iii) Cost ledger control account makes the cost ledger self-balancing.
- (iv) There is inverse relationship between batch size and carrying costs.
- (v) Marginal costing follows the identifiability wise classification of costs.

(d) **Fill in the blanks** (You may write only the Roman numeral and the content filling blanks):

1x5=5

- (i) \_\_\_\_\_ is discount allowed to the bulk purchaser.
- (ii) CAS \_\_\_\_\_ stands for cost of utilities.
- (iii) Under integrated accounting system, the accounting entry for payment of wages is to debit \_\_\_\_\_ and to credit cash account.
- (iv) If the actual loss in a process is less than the normal loss, the difference is known as \_\_\_\_\_.
- (v) The principal budget factor for consumer goods manufacturer is normally \_\_\_\_\_.

### Section-B

*Answer any five questions from question numbers 2 to 8.*

*Each question carries 15 marks.*

15x5=75

2. (a) ZEDYAAH TUBES LTD. manufactures a special product, which requires ZEDY. The following particulars were collected for the year 2017-18:

- (i) Monthly demand of Zedy : 7500 units
- (ii) Cost of placing an order : ₹500
- (iii) Re-order period : 5 to 8 weeks
- (iv) Cost per unit : ₹ 60
- (v) Carrying cost % p.a. : 10%



- (vi) Normal usage : 500 units per week  
 (vii) Minimum usage : 250 units per week  
 (viii) Maximum usage : 750 units per week

*Required:*

Calculate the following:

- (i) Re-order quantity  
 (ii) Re-order level  
 (iii) Minimum stock level  
 (iv) Maximum stock level  
 (v) Average stock level

7

- (b) SONAX LTD. has three Production Departments and two Service Departments. The overhead distribution sheet showed the following totals:

	₹
Production Departments:	
A	25,000
B	31,000
C	28,000
Service Departments:	
S	8,000
T	13,900

*Required:*

Using the following bases of apportionment, distribute the cost of service departments under Simultaneous Equation Method:

	A	B	C	S	T
Department S	30%	20%	40%	-	10%
Department T	40%	15%	25%	20%	-

8

3. (a) What are the various types of materials included in the Material Cost as dealt with by CAS-6 relating to Cost Accounting Standard on Material Cost?

State the objective and scope of the Standard.

6

- (b) The following information is available from the financial books of PQR Ltd. having a normal production capacity of 60000 units for the year ended 31 st March, 2018:

- (i) Sales ₹ 10,00,000 (50000 units)  
 (ii) There was no opening and closing stock of finished units.  
 (iii) Direct material and direct wages costs were ₹ 5,00,000 and ₹ 2,50,000 respectively.  
 (iv) Actual factory expenses were ₹ 1,50,000 of which 60% are fixed.  
 (v) Actual administrative expenses were ₹45,000 which are completely fixed.



- (vi) Actual selling and distribution expenses were ₹ 30,000 of which 40% are fixed.  
 (vii) Interest and dividends received ₹ 15,000

You are required to

- (A) find out profit as per financial books for the year ended 31st March, 2018.  
 (B) prepare the cost sheet and ascertain the profit as per cost accounts for the year ended 31st March, 2018 assuming that the indirect expenses are absorbed on the basis of normal production capacity.  
 (C) prepare a statement reconciling profits shown by financial and cost books.

9

4. (a) Z Ltd., manufactured and sold 200 typewriters in the year 2017. Its summarised Trading and Profit & Loss Account for the year 2017 is as follows:

**Total Output (in units) 200**

Particulars	₹	Particulars	₹
To Cost of Material consumed	1,20,000	By Sales	6,00,000
To Direct Wages	1,80,000		
To Manufacturing Charges	75,000		
To Gross Profit c/d	2,25,000		
	6,00,000		6,00,000
To Management Expenses	90,000	By Gross Profit b/d	2,25,000
To General Expenses	30,000		
To Rent, Rates & Taxes	15,000		
To Selling Expenses	45,000		
To Net Profit	45,000		
	2,25,000		2,25,000

For the year 2018, it is estimated that

- (i) The output and sales will be 300 typewriters.  
 (ii) Price of material will rise by 25% compared to previous year level.  
 (iii) Wages per unit will rise by 10%.  
 (iv) Manufacturing charges will increase in proportion to the combined cost of material and wages.  
 (v) Selling expenses per unit will remain unchanged.  
 (vi) Other expenses will remain unaffected by the rise in output.

Required:

**Prepare a Cost Sheet** showing the cost at which typewriters will be manufactured in 2018 and give price at which it should be marketed so as to show profit of 10% on selling price.

8



- (b) The following details are extracted from the costing records of EVINIE LTD., an oil mill for the year ended 31st March, 2018. Purchased 2000 tons of copra for ₹1,00,000 and other expenses were as under:

	Crushing (₹)	Refining (₹)	Finishing (₹)
Cost of Labour	10,000	6,000	4,000
Sundry Material	4,000	3,000	2,000
Electric Power	3,000	2,000	1,600
Steam	2,000	2,000	1,500
Repair of Machine	2,000	1,000	500
Cost of Casks	–	–	7,500

Factory Expenses were ₹10,000 to be apportioned on the basis of wages. 1700 tons of crude oil was produced; 1540 tons of oil was refined and finally 1500 tons of oil was finished for delivery. Realised ₹2,000 from sale of sacks; ₹5,000 by sale of 250 tons of copra residue and ₹5,100 by sale of 120 tons of by-products in refining pro,

Prepare Process Accounts for the year ending on 31st March, 2018.

7

5. (a) GOLDEN TRANSPORT CO. has been given a route 20km. long for running buses. The company has a fleet of 10 buses each costing ₹ 60,000 and having a life of 5 years without any scrap value.

The following are estimated expenditure and other details:

(i) Insurance charges	3% p.a.
(ii) Annual tax for each bus	₹ 3,000
(iii) Total garage charges	₹ 4,000 p.m.
(iv) Driver's salary for each bus	₹ 10,000 p.m.
(v) Conductor's salary for each bus	₹ 7,000 p.m.
(vi) Annual repairs to each bus	₹ 6,000
(vii) Commission to be shared by the driver and conductor equally: 10% of the takings	
(viii) Cost of stationary	₹ 1,500 p.m.
(ix) Manager's salary	₹ 12,000 p.m.
(x) Accountant's salary	₹ 9,000 p.m.
(xi) Petrol and oil	₹ 400 per 100 km

Each bus will make 3 round trips carrying on an average 40 passengers on each trip. The bus will run on an average for 25 days in a month.

Assuming 15% profit on takings, **Calculate the bus fare** to be charged from each - passenger.

8

- (b) OMEGA LTD. undertook a contract for ₹ 5,00,000 on 1st January, 2017. The company furnishes the following details for the year ended 31st December, 2017:

	₹
Materials consumed	1,65,000
Direct Expenses	5,000
Wages	30,000
Materials returned to stores	5,000
Materials stolen from site	10,000
Insurance claim admitted	6,000



Works expenses @ 20% on wages	
Office expenses @ 10% on works cost	
Materials in hand on 31.12.2017	15,000
Cash received to the extent of 90% of works certified	2,70,000
Cost of work uncertified	11,000

Plant sent to site costing ₹ 60,000 with a scrap value of ₹ 10,000 and its useful life is 5 years. The plant was used on the contract for 146 days.

Required:

**Prepare Contract Account** showing therein the cost of materials issued to site and the amount of profit or loss to be transferred to the Profit & Loss Account. 7

6. (a) A company budgets for a production of 5 lakh units at a variable cost of ₹ 20 each. The fixed costs are ₹20 lakh. The selling price is fixed to yield a profit of 25% on cost.

You are required to **calculate**

- (i) P/V Ratio and Break even point.
- (ii) If the selling price is reduced by 20%.

Ascertain:

- (A) The effect of price reduction on the P/V Ratio and BEP.
- (B) The number of units required to be sold at the reduced selling price to obtain an increase of 20% over the budgeted profit. 8

- (b) AVONA LTD.. a toy factory presents the following information for the year endi March, 2018:

	₹
Material cost	1,20,000
Labour cost	2,40,000
Fixed overheads	1,20,000
Variable overheads	60,000
Units produced	12,000
Selling Price per Unit	50

The available capacity is a production of 20000 units per year. The firm has an offer for the purchase of 5000 additional units at a price of ₹ 40 per unit. It is expected that accepting this offer there will be a saving of rupee one per unit in material cost on all ui manufactured, the fixed overhead will increase by ₹ 35,000 and the overall efficiency will drop by 2% on all production.

**State whether offer** is acceptable or not. 7

7. (a) The details regarding the composition and the weekly wage rates of labour force of PB LTD engaged on a job scheduled to be completed in 30 weeks are as follows:

Category of Workers	Standard		Actual	
	No. of Workers	Weekly Wage Rate per worker (₹)	No. of Workers	Weekly Wage Rate per worker (₹)
Skilled	75	60	70	70
Semi-Skilled	45	40	30	50
Unskilled	60	30	80	20

The work is actually completed in 32 weeks.



**Calculate** the following Labour Variances:

- (i) Labour Cost Variance (LCV)
- (ii) Labour Rate Variance (LRV)
- (iii) Labour Efficiency Variance (LEV)
- (iv) Labour Revised Efficiency Variance (LREV)
- (v) Labour Mix Variance (LMV)

(b) NP LTD produces a standard product. The estimated costs are given below:

	₹
Raw Materials	10
Direct Wages	8
Direct Expenses	2
Variable Overheads	<u>3</u>
	<u>23</u>

Semi-variable overheads at 100% capacity level (10,000 units) are expected to be ₹ 40,000 and these overheads vary in steps of ₹ 2,000 for each change in output of 1,000 units. Fixed overheads are estimated at ₹ 50,000. Selling price per unit is expected to be ₹ 40.

Required:

**Prepare a Flexible Budget** at 50%, 70% and 90% level of activity on marginal cost basis.

7

**8. Answer any three out of the following four questions:**

5x3=15

- (a) State the advantages of cost control (*any five*).
- (b) Describe briefly the main scope of cost accountancy.
- (c) What is just-in-time (JIT) system? List out its main benefits.
- (d) Write a brief note on Performance Budgeting describing its main concepts.





## INTERMEDIATE EXAMINATION

June 2018

**P-8 (CAC)**  
**Syllabus 2016**

### Cost Accounting

Time Allowed: 3 Hours

Full Marks: 100

*The figures in the margin on the right side indicate the full marks.*

*All Sections are compulsory. Each section contains instructions regarding the number of questions to be answered within the section.*

*All working notes must form part of the answer.*

*Wherever necessary, candidates may make appropriate assumptions and clearly state them.*

*No present value factor table or other statistical table will be provided in addition to this question paper.*

#### Section-A

***Section A contains Question Number 1. All parts of this question are compulsory.***

**1. Answer the following questions:**

- (a) Choose the correct answer from the given alternatives (You may write only the Roman numeral and the alphabet chosen for your answer): 1x10=10
- (i) Batch costing is suitable for
- (a) Oil Industry
  - (b) Sugar Industry
  - (c) Chemical Industry
  - (d) Pharmaceutical Industry
- (ii) Idle time is
- (a) Time spent by workers in office
  - (b) Time spent by workers in factory
  - (c) Time spent by workers off their work
  - (d) Time spent by workers on their job
- (iii) Warehouse expense is an example of
- (a) Production overhead
  - (b) Administration overhead
  - (c) Selling overhead
  - (d) Distribution overhead



- (iv) Standard deals with the principles and methods of determining depreciation and amortization cost is
- (a) CAS-8
  - (b) CAS-11
  - (c) CAS-16
  - (d) CAS-20
- (v) In Reconciliation Statement expenses shown only in cost accounts are
- (a) Added to financial profit
  - (b) Deducted from financial profit
  - (c) Ignored
  - (d) Deducted from costing profit
- (vi) In a job cost system, costs are accumulated
- (a) On a monthly basis
  - (b) By specific job
  - (c) By department or process
  - (d) By kind of material used
- (vii) In a process 6,000 units are introduced during a period. 5% of input is normal loss. Closing work-in-process 60% complete is 800 units. 4,900 completed units are transferred to next process. Equivalent production for the period is
- (a) 6,800 units
  - (b) 5,700 units
  - (c) 5,680 units
  - (d) 5,380 units
- (viii) Which of the following best describes a fixed cost?
- (a) It may change in total where such change is unrelated to changes in production.
  - (b) It may change in total where such change is related to changes in production.
  - (c) It is constant per unit of change in production.
  - (d) It may change in total where such change depends on production within the relevant range.
- (ix) Z Ltd. is planning to sell 1,00,000 units of product A for ₹ 12.00 per unit. The fixed costs are ₹ 2,80,000. In order to realize a profit of ₹ 2,00,000, what would the variable costs be?
- (a) ₹ 4,80,000
  - (b) ₹ 7,20,000
  - (c) ₹ 9,00,000
  - (d) ₹ 9,20,000
- (x) Sales budget is an example of
- (a) Expenditure budget
  - (b) Functional budget
  - (c) Capital budget
  - (d) Master budget



(b) **Match the statement in Column I with the most appropriate statement in Column II:**

(You may opt to write only the Roman numeral and the matched alphabet instead of copying contents into the answer Books) 1x5=5

	Column I		Column II
(i)	Imputed costs	A	Cost control technique
(ii)	FSN analysis	B	Treated as part of factory expenses
(iii)	Captive power plant expenses	C	Costing profit and loss account
(iv)	Abnormal loss is transferred to	D	Process of classifying material
(v)	Variance analysis	E	Direct allocation
		F	Not involving cash outlay
		G	Management by exception
		H	Decision package

(c) **State whether the following statements are 'True' or 'False':**(You may write only the Roman numeral and whether 'True' or 'False' without copying the statements into the answer books): 1x5=5

- (i) Factory overhead cost applied to a job is usually based on a pre-determined rate.
- (ii) CAS-19 deals with the principles and methods of determining the manufacturing cost of excisable goods.
- (iii) Cost ledger control account makes the cost ledger self-balancing.
- (iv) FIFO method is followed for evaluation of equivalent production when prices are fluctuating.
- (v) Standard costs and budgeted costs are inter-related and inter-dependent.

(d) **Fill in the blanks :** (You may write only the Roman numeral and the content filling the blanks) 1x5=5

- (i) \_\_\_\_\_ is the process of regulating the action so as to keep the element of cost within the set parameters.
- (ii) In absorption costing \_\_\_\_\_ is added to inventory.
- (iii) CAS \_\_\_\_\_ stands for cost of service cost centre.
- (iv) At \_\_\_\_\_ contribution available is equal to total fixed cost.
- (v) The document which describes the budgeting organisation, budgeting procedure etc. is known as \_\_\_\_\_.

**Section-B**

Answer **any five** questions from question numbers 2 to 8.

Each question carries 15 marks.

15x5=75

2. (a) The existing Incentive system of SHRISTI LTD is as under:

Normal working week : 5 days of 8 hours each plus 3 late shifts of 3 hours each

Rate of Payment : Day work : ₹160 per hour

Late shift : ₹225 per hour

Average output per operator

for 49-hours week i.e. including



3 late shifts : 120 articles.

In order to increase output and eliminate overtime, it was decided to switch on to a system of payment by results. The following information is obtained:

Time-rate (as usual) : ₹160 per hour  
 Basic time allowed for 15 articles : 5 hours  
 Piece-work rate : Add 20% to basic piece-rate  
 Premium Bonus : Add 50% to time.

**Required:**

Prepare a Statement showing hours worked, weekly earnings, number of articles produced and labour cost per article for one operator under the following systems: (i) Existing time-rate

(ii) Straight piece-work

(iii) Rowan system

(iv) Halsey premium system

Assume that 135 articles are produced in a 40-hour week under straight piece work, Rowan Premium System, the Halsey Premium System above and worker earns half the time saved under Halsey Premium System. 9

(b) The following figures are taken from the accounts of BALEN LTD a manufacturing concern for the month of October, 2017:

Indirect Materials : Production Departments : X ₹19,000; Y ₹24,000; Z ₹4,000;  
 Service Departments : Maintenance ₹ 30,000; Stores ₹ 8,000.

Indirect Wages : Production Departments : X ₹18,000; Y ₹22,000; Z ₹6,000;  
 Service Departments : Maintenance ₹ 20,000; Stores ₹ 13,000.

Other Expenses : Power and Light : ₹1,20,000; Rent and Rates ₹56,000; Insurance of Assets ₹20,000; Meal Charges ₹60,000; Depreciation @ 6% p.a. on capital value of assets.

**Departmental Data**

Items	Production Departments			Service Department	
	X	Y	Z	Maintenance	Stores
Area (Sq. Ft.)	4,000	4,000	3,000	2,000	1,000
Capital Value of Assets (₹)	20,00,000	24,00,000	16,00,000	12,00,000	8,00,000
Kilowatt Hours	2,000	2,200	800	750	250
Number of Employees	180	240	60	80	40

Service rendered by Maintenance Department to Production Departments:

X 50%; Y 30%; Z 20%.

Service rendered by Stores Department to Production Departments:

X 40%; Y 40%; Z 20%.

From the above data, **prepare a** Departmental Distribution Summary showing apportionment of costs of Service Departments to the Production Departments and the Total Overheads of the Production Departments. 6

3. (a) What are the Direct Expenses as defined in CAS-10 (Limited Revision 2017)? Also discuss the general principles of its measurement as per CAS-10. (any five only) 6



- (b) The net profit of X Ltd., appeared at ₹41,800 as per financial records for the year ending 31st March, 2018. A scrutiny of the figures from both the sets of accounts revealed the following facts:

	₹
Works overhead under-recovered in costs	1,500
Administrative overheads over-recovered in costs	850
Depreciation charged in financial accounts	5,600
Depreciation recovered in costs	6,250
Interest on investments not included in costs	3,000
Loss due to obsolescence charged in financial accounts	2,850
Income tax reserve made in financial accounts	20,150
Bank interest and transfer fee credited in financial books	370
Stores adjustment (credit) in financial books	230
Value of opening stock in : Cost accounts	24,800
: Financial accounts	26,300
Value of closing stock in : Cost accounts	25,000
: Financial accounts	23,000
Interest charged in cost accounts	2,000
Imputed rent charged in cost accounts	1,000
Goodwill written off	5,000
Loss on sale of furniture	600
Selling and distribution expenses not charged in cost accounts	10,000
Donations to Prime Minister's Relief Fund	5,100
Transfer to Debenture Redemption Fund	9,000
Transfer to Dividend Equalisation Fund	20,500

**Required:**

Prepare a statement showing the reconciliation statement and findout the profit as per cost Accounts. 9

4. (a) The following data are available from the books and records of VEEMYES Ltd. for the month of November 2017.

Direct Labour cost : ₹ 20,000 (125% of factory overheads)

Inventory accounts show the following figures:

	November 1	November 30
	₹	₹
Raw materials	10,000	20,000
Work in progress	8,000	4,000
Finished goods	10,000	5,000
Selling expenses		15,000
Office expenses		10,000
Sales		1,25,000



The company maintains a profit of 25% on cost.

You are **required** to **prepare** a cost sheet for the month of November 2017 with all elements. 8

- (b) CBA Ltd. , manufactures certain grades of products known as M, B1 and B2. In course of manufacture of product M (main product), by-products- B1 and B2 emerge. The joint expenses of manufacture amount to ₹2,37,600.

All the three products are processed further after separation and sold as per details given below:

	Product-M	(By products)	
		Product B1	Product B2
Sales (₹)	2,00,000	1,20,000	80,000
Cost incurred after separation (₹)	20,000	15,000	10,000
Profit as percentage on sales	25	20	15

Total fixed selling expenses are 10% of total cost of sales which are apportioned to the three products in the ratio of 20:40:40.

**Required:**

- Prepare a statement showing the apportionment of joint costs to the products (M, B1 and B2)
- If the product B1 (by product) is not subject to further processing and is sold at the point of separation, for which there is a market at ₹1,00,440 without incurring any selling expenses, would you advise its disposal at this stage? Show the workings. 7

5. (a) JANATA TRANSPORT LTD. a Transport Company is running 4 buses between two towns which are 50 kms. away. Seating capacity of each bus is 40 passengers. The following information is obtained from its books for November, 2017:

Particulars	₹
Wages of drivers, conductors and cleaners	24,000
Salaries of office and supervisory staff	10,000
Diesel, oil and other lubricants	40,000
Repairs and maintenance	8,000
Taxes, insurance etc.	16,000
Depreciation of buses	26,000
Interest and other charges	20,000

Actual passengers carried were 75% of the seating capacity. All the 4 buses ran on all the days of the month. Each bus made one to and fro round trip per day.

**Prepare the Operating Cost Statement** and determine the cost per passenger km. for each bus. 8

- (b) A contractor, who prepare his accounts on 31st March each year, commenced a Contract No. 220 on 1st July, 2016. The following information is revealed from his costing records on 31st March, 2017:

Particulars	(₹)
Materials sent to site	2,51,000
Labour	5,65,600
Foreman's salary	81,300

A machine costing ₹2,60,000 remained in use on site for 146 days. Its working life is estimated at 7 years and final scrap value at ₹15,000. A supervisor is paid ₹8,000 per month and has devoted one half of his time on the contract. All other expenses amount to ₹1,36,500. Materials at site on 31st March, 2017 cost ₹35,400.



The contract price is ₹20,00,000. On 31st March, 2017 two-third of the contract was completed, however, the architect gave certificate only for 50% of the contract price and ₹7,50,000 had so far been paid on account.

**Prepare** Contract Account and state how much profit or loss should be included on 31st March, 2017 in financial accounts. 7

6. (a) ANKIT LTD. a manufacturing Company which produces three products furnishes the following information for the year 2016-17:

Particulars	Products		
	A	B	C
Selling Price (per unit)	₹200	₹150	₹100
Profit Volume Ratio	10%	20%	40%
Raw Material content as a % of Variable Cost	50%	50%	50%
Maximum Sales Potential (units)	40,000	25,000	10,000

Fixed costs are estimated at ₹12 lakhs. The firm uses same raw material in all the three products. Raw material is in 'Short Supply'. The firm has a quota for the supply of raw materials of the value of ₹36 lakhs for the year 2016-17 for the production of three products to meet sales demand.

**Required:**

Determine the optimal product mix and ascertain the maximum profit therefrom. 8

- (b) The following figures are obtained from the records of P. Ltd.:

	2015-16 (₹)	2016-17 (₹)
Sales	80,000	1,00,000
Net Profit	10,000	16,000

**Required'.**

Calculate the following:

- (i) Profit Volume Ratio
  - (ii) Break Even Point
  - (iii) Profit or loss at sales of ₹40,000
  - (iv) Sales required to earn a profit of ₹22,000
  - (v) Margin of Safety if sales in ₹55,000
- 7

7. (a) The standard cost card of A & Co. shows the following costs:

Material cost - 2 kg @ ₹2.50 each	₹5.00 per unit
Wages - 2 hours @ 50 paise each	₹1.00 per unit

The actual data from business operations are as follows:

Production	8,000 units
------------	-------------

Actual total cost of production:

Material cost - 16,500 kg @ ₹ 2.40 each	₹39,600
Wages -18,000 hours @ 40 paise each	₹7,200



Calculate the following variances:

- (i) Material Cost Variance (MCV);
- (ii) Material Price Variance (MPV);
- (iii) Material Usage Variance (MUV);
- (iv) Labour Cost Variance (LCV);
- (v) Labour Rate Variance (LRV);
- (vi) Labour Efficiency Variance (LEV).

8

- (b) Summarised below are the revenue and expenditure figures of AB Ltd. for the month of March to August, 2017:

Month	Sales (₹)	Purchases (₹)	Wages (₹)	Expenses (₹)
March	6,50,000	4,00,000	1,20,000	50,000
April	7,00,000	4,80,000	1,50,000	50,000
May	7,50,000	4,50,000	1,50,000	60,000
June	8,00,000	4,80,000	1,80,000	60,000
July	8,20,000	4,00,000	1,80,000	80,000
August	8,90,000	5,00,000	2,00,000	80,000

The following further information is available:

- (i) 10% Purchases and sales are on cash basis.
- (ii) Advance payment of income tax in August, 2017 ₹50,000.
- (iii) Plant purchased and price to be paid in June, 2017 ₹1,00,000.
- (iv) Time lag—

Credit sales	2 months
Credit purchases	1 month
Wages	1/2 month
Expenses	1/2 month

**Required:**

Prepare a Cash Budget for 3 months starting on 1st June, 2017 when cash balance is ₹2,00,000.

7

**8. Answer any three out of the following four questions:**

5x3=15

- (a) Differentiate between cost control and cost reduction.
- (b) Cost accounting has emerged as a specialized discipline due to various factors. List out these factors. (Any five)
- (c) What is Economic Order Quantity (EOQ)? State the assumptions underlying EOQ.
- (d) What is Principal Budget Factor? Explain your answer with suitable example.

**The Directorate of Studies is committed to keep abreast of CMA Students with the latest amendments/notifications/advancements on each subject on regular basis. Students are requested to visit CMA Students' Portal [<https://icmai.in/studentswebsite/>] regularly to view the updates.**