

INTERMEDIATE : PAPER -

10

SYLLABUS - 2016

# COST & MANAGEMENT ACCOUNTING AND FINANCIAL MANAGMENT INTERMEDIATE

## STUDY NOTES

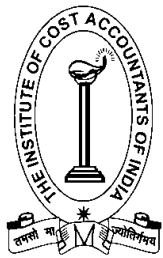

**The Institute of Cost Accountants of India**

CMA Bhawan, 12, Sudder Street, Kolkata - 700 016

First Edition: August 2016  
Reprint: September 2017  
Reprint: January 2018  
Reprint: June 2018  
Reprint: January 2019  
Edition: August 2019  
Edition: October 2019  
Reprint: August 2020  
Reprint: October 2020  
**Reprint : January 2021**

**Published by :**

Directorate of Studies  
The Institute of Cost Accountants of India (ICAI)  
CMA Bhawan, 12, Sudder Street, Kolkata - 700 016

**Printed at :**

M/s. SAP Print Solutions Pvt. Ltd.  
28A, Lakshmi Industrial Estate  
S.N. Path, Lower Parel (W)  
Mumbai - 400 013, Maharashtra

---

Copyright of these Study Notes is reserved by the Institute of Cost Accountants of India and prior permission from the Institute is necessary for reproduction of the whole or any part thereof.

---

# Syllabus - 2016

## PAPER 10: COST & MANAGEMENT ACCOUNTING AND FINANCIAL MANAGEMENT (CMAFM)

### Syllabus Structure

The syllabus comprises the following topics and study weightage:

A	Cost & Management Accounting	50%
B	Financial Management	50%

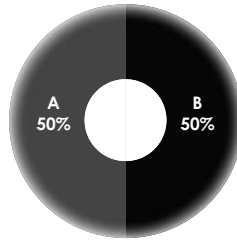

### ASSESSMENT STRATEGY

There will be written examination paper of three hours.

### OBJECTIVE

To provide an in depth knowledge of the detailed procedures and documentation involved in cost ascertainment systems. To understand the concepts of Financial Management and its application for managerial decision making.

### Learning Aims

The syllabus aims to test the student's ability to:

- Understand the cost and management accounting techniques for evaluation, analysis and application in managerial decision making;
- Compare and contrast marginal and absorption costing methods in respect of profit reporting;
- Apply marginal and absorption costing approaches in job, batch and process environments;
- Prepare and interpret budgets and standard costs and variance statements;
- Identify and apply the concepts of Financial Management

### Skill Set required

Level B: Requiring the skill levels of knowledge, comprehension, application and analysis.

Note: Subjects related to applicable statutes shall be read with amendments made from time to time.

<b>Section A : Cost &amp; Management Accounting</b>	<b>50%</b>
1. Cost and Management Accounting - Introduction	
2. Decision Making Tools	
3. Budgeting and Budgetary Control	
4. Standard Costing and Variance Analysis	
5. Learning Curve	
<b>Section B : Financial Management</b>	<b>50%</b>
6. Introduction to Financial Management	
7. Tools for Financial Analysis and Planning	
8. Working Capital Management	
9. Cost of Capital, Capital Structure Theories, Dividend Decisions and Leverage Analysis	
10. Capital Budgeting - Investment Decisions	

## **SECTION A: COST & MANAGEMENT ACCOUNTING [50 MARKS]**

### **1. Cost and Management Accounting:**

Introduction to Management Accounting - Relationship between Management Accounting and Cost Accounting

### **2. Decision Making Tools:**

(a) Marginal Costing; Break Even Analysis and Cost - volume - profit analysis; break-even charts and profit charts; differential cost analysis; stock valuation under marginal costing vs. absorption costing; applications of marginal costing in decision making.

(b) Transfer Pricing - Determination of Inter-departmental or Inter-company Transfer Price

### **3. Budgeting and Budgetary Control:**

(a) Budgetary Control and Preparation of Functional and Master Budgeting.

(b) Fixed, Variable, Semi-Variable Budgets

(c) Zero Based Budgeting (ZBB)

### **4. Standard Costing & Variance Analysis:**

Computation of variances for each of the elements of costs, Sales Variances, Investigation of variances - Valuation of Stock under Standard Costing - Uniform Costing and inter-firm comparison.

### **5. Learning Curve:**

Concept of Learning curve and its application.

## **SECTION B: FINANCIAL MANAGEMENT [50 MARKS]**

### **6. Introduction to Financial Management:**

Meaning - Objectives - Scope of Financial Management sources of Finance - Introduction to Financial Markets.

### **7. Tools for Financial Analysis and Planning:**

Financial Ratio Analysis - Funds Flow Analysis - Cash Flow Analysis.

### **8. Working Capital Management**

Working Capital Management - Financing of Working Capital

### **9. Cost of Capital, Capital Structure Theories, Dividend Decisions and Leverage Analysis**

Meaning of Cost of Capital - Computation of Cost of Capital - Capital Structure Theories and Dividend Decisions Theories (Walters - MM - Gordon Models) - Leverage Analysis

### **10. Capital Budgeting - Investment Decisions:**

Concept of Capital Budgeting - Non-Discounted and Discounted Cash Flow Method - Ranking of Projects.

# Contents

## SECTION A - COST & MANAGEMENT ACCOUNTING

### Study Note 1 : Cost and Management Accounting – Introduction

1.1	Introduction	1
1.2	Management Accounting - Definition	2
1.3	Objectives of Management Accounting	3
1.4	Role of Management Accounting in Management Process	3
1.5	Functions of Management Accounting	4
1.6	Significance of Management Accounting	6
1.7	Limitations of Management Accounting	6
1.8	Relationship between Management Accounting and Cost Accounting	7

### Study Note 2 : Decision Making Tools

2.1	Marginal Costing	11
2.2	Determination of Cost and Profit under Marginal Costing	14
2.3	Realities about Marginal Costing	15
2.4	Techniques of Marginal Costing	15
2.5	Differential Cost Analysis	27
2.6	Differences between Absorption Costing and Marginal Costing	29
2.7	Application of Marginal Costing in Decision Making	29
2.8	Transfer Pricing	41
2.9	Objectives of Inter Company Transfer Pricing	42
2.10	Methods of Transfer Pricing	42

### Study Note 3 : Budgeting and Budgetary Control

3.1	Budgetary Control and Preparation of Functional and Master Budgeting	103
3.2	Fixed, Variable, Semi-variable Budgets	110
3.3	Zero Based Budgeting (ZBB)	112

### Study Note 4 : Standard Costing and Variance Analysis

4.1	Introduction	135
4.2	Computation of Variances for each of the Elements of Costs, Sales Variances	138
4.3	Investigation of Variances & Reporting of Variances	152
4.4	Valuation of Stock under Standard Costing	154
4.5	Uniform Costing and Inter-firm Comparison	155

### **Study Note 5 : Learning Curve**

5.1	Introduction	193
5.2	Phases in Learning Curve	193
5.3	Uses of Learning Curve	195
5.4	Limitations of the usefulness of the Learning Curve	196
5.5	Factors affecting Learning Curve	196
5.6	The Experience Curve	197
5.7	Reasons for use of Learning Curve	198
5.8	Application of Learning Curve	199

## **SECTION B - FINANCIAL MANAGEMENT**

### **Study Note 6 : Introduction to Financial Management**

6.1	Meaning	205
6.2	Objectives	206
6.3	Scope of Financial Management	207
6.4	Sources of Finance	214
6.5	Introduction to Financial Markets	228

### **Study Note 7 : Tools for Financial Analysis and Planning**

7.1	Financial Ratio Analysis	245
7.2	Fund Flow Analysis	272
7.3	Cash Flow Analysis	275

### **Study Note 8 : Working Capital Management**

8.1	Working Capital Management - Financing of Working Capital	313
8.2	Inventory Management	336
8.3	Management of Receivables	337
8.4	Determinant of Credit Policy	339
8.5	Evaluation of Credit Policy	341
8.6	Cash Management	352

### **Study Note 9 : Cost of Capital, Capital Structure Theories, Dividend Decisions and Leverage Analysis**

9.1	Meaning of Cost of Capital – Computation of Cost of Capital	367
9.2	Capital Structure Theories	397
9.3	Dividend Policy	419
9.4	Leverage Analysis	439
9.5	EBIT - EPS Indifference Point/Level	441

### **Study Note 10 : Capital Budgeting - Investment Decision**

10.1	Capital Budgeting	465
10.2	Need of Capital Budgeting Decision	466
10.3	Significance of Capital Budgeting Decisions	466
10.4	Process of Capital Budgeting	467
10.5	Control for Capital Expenditure	468
10.6	Investment Criterion - Methods of Appraisal	468





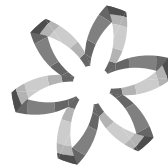

---

**Section A**  
**Cost & Management Accounting**  
**(Syllabus - 2016)**

---







# Study Note - 1

## COST AND MANAGEMENT ACCOUNTING – INTRODUCTION



This Study Note includes:

- 1.1 Introduction
- 1.2 Management Accounting – Definition
- 1.3 Objectives of Management Accounting
- 1.4 Role of Management Accounting in Management Process
- 1.5 Functions of Management Accounting
- 1.6 Significance of Management Accounting
- 1.7 Limitations of Management Accounting
- 1.8 Relationship between Management Accounting and Cost Accounting

### 1.1 INTRODUCTION

Accounting involves collection, recording, classification and presentation of financial data. The word 'Accounting' can be classified into three categories: (A) Financial Accounting (B) Management Accounting and (C) Cost Accounting.

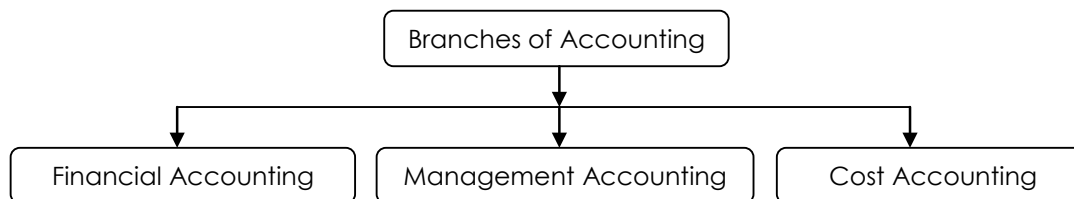

#### FINANCIAL ACCOUNTING:

Financial Accounting has come into existence with the development of large-scale business in the form of joint-stock companies. As public money is involved in share capital, Companies Act has provided a legal framework to present the operating results and financial position of the company. Financial Accounting is concerned with the preparation of Profit and Loss Account and Balance Sheet to disclose information to the shareholders. Financial accounting is oriented towards the preparation of financial statements, which summarises the results of operations for select periods of time and show the financial position of the business on a particular date. Financial Accounting is concerned with providing information to the external users. Preparation of financial statements is a statutory obligation. Financial Accounting is required to be prepared in accordance with Generally Accepted Accounting Principles and Practices. In fact, the corporate laws that govern the enterprises not only make it mandatory to prepare such accounts, but also lay down the format and information to be provided in such accounts. In sharp contrast, management accounting is entirely optional and there is no standard format for preparation of the reports. Financial Accounts relate to the business as a whole, while management accounts focuses on parts or segments of the business.

#### CONCEPT OF MANAGEMENT ACCOUNTING:

Management Accounting is a new approach to accounting. The term Management Accounting is composed of two words — Management and Accounting. It refers to Accounting for the Management.



Management Accounting is a modern tool to management. Management Accounting provides the techniques for interpretation of accounting data. Here, accounting should serve the needs of management. Management is concerned with decision-making. So, the role of management accounting is to facilitate the process of decision-making by the management. Managers in all types of organizations need information about business activities to plan, accurately, for the future and make decisions for achieving the goals of the enterprise. Uncertainty is the characteristic of the decision-making process. Uncertainty cannot be eliminated, altogether, but can be reduced. The function of Management Accounting is to reduce the uncertainty and help the management in the decision making process. Management accounting is that field of accounting, which deals with providing information including financial accounting information to managers for their use in planning, decision-making, performance evaluation, control, management of costs and cost determination for financial reporting. Managerial accounting contains reports prepared to fulfil the needs of managements.

## 1.2 MANAGEMENT ACCOUNTING - DEFINITION

Different authorities have provided different definitions for the term 'Management Accounting'. Some of them are as under:

"Management Accounting is concerned with accounting information, which is useful to the management". — Robert N. Anthony

"Management Accounting is concerned with the efficient management of a business through the presentation to management of such information that will facilitate efficient planning and control". —Brown and Howard

"Any form of Accounting which enables a business to be conducted more efficiently can be regarded as Management Accounting" — The Institute of Chartered Accountants of England and Wales

The Certified Institute of Management Accountants (CIMA) of UK defines the term 'Management Accounting' in the following manner:

"Management Accounting is an integral part of management concerned with identifying, presenting and interpreting information for:

1. Formulating strategy
2. Planning and controlling activities
3. Decision taking
4. Optimizing the use of resources
5. disclosure to shareholders and others, external to the entity
6. disclosure to employees
7. safeguarding assets

From the above definitions, it is clear that the management accounting is concerned with that accounting information, which is useful to the management. The accounting information is rearranged in such a manner and provided to the top management for effective control to achieve the goals of business. Thus, management accounting is concerned with data collection from internal and external sources, analyzing, processing, interpreting and communicating information for use, within the organization, so that management can more effectively plan, make decisions and control operations. The information to be collected and analysed has been extended to its competitors in the industry. This provides more meaningful clues for proper decision-making in the right direction.

The information in the management accounting system is used for three different purposes:

1. Measurement
2. Control and
3. Decision-making



### 1.3 OBJECTIVES OF MANAGEMENT ACCOUNTING

The basic objectives of management Accounting are to help management in the creation of policy and regular operation of the business. It provides relevant accounting information to the management for use in planning, organising, decision- making and control at the appropriate time.

The main objectives of management accounting may be enumerated as follows:

1. Providing management with accounting, costing , and other statistical data for use in planning and decision- making
2. Computing and presenting to the management the financial results of alternative courses of action to decide on the best alternative
3. Translating the management plans covering all financial activities of business
4. Verifying the figures for business activities to judge consistency and practicability for need of revision of plans, if any
5. Financial interpretation of plans to pinpoint individual responsibilities
6. Measuring actual performance against standards, and reporting the results of the operations to the appropriate level of management
7. Measuring and reporting on the effectiveness of the enterprise

### 1.4 ROLE OF MANAGEMENT ACCOUNTING IN MANAGEMENT PROCESS

An enterprise would operate, successfully, if it directs all its resources and efforts to accomplish its specified objective in a planner manner, rather than reacting to events.

Organisation has to be both efficient and effective. Organisation is effective when the planned objective is achieved. However, the firm is efficient only when the objective is achieved, with minimum cost and resources, both in physical and monetary terms. The role of Management Accounting is significant in making the firm both efficient and effective. Management Accounting has brought out clear shift in the objective of accounting. From mere recording of transactions, the emphasis is on analyzing and interpreting to help the management to secure better results. In this way, Management Accounting eliminates intuition, which is not at all dependable, from the field of business management to the cause and effect approach.

The basic functions of management are:

1. Planning,
2. Organising,
3. Controlling,
4. Decision-making and
5. Staffing

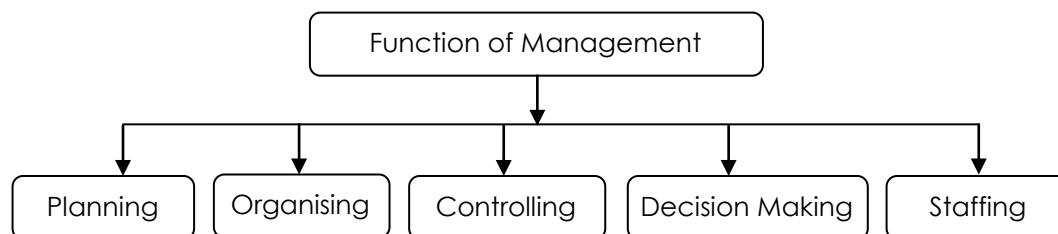



Management accounting plays a vital role in the managerial functions performed by the managers.

- (1) **Planning:** Planning is the real beginning of any activity. Planning establishes the objectives of the firm and decides the course of action to achieve it. It is concerned with formulating short-term and long-term plans to achieve a particular end. Planning is a statement of what should be done, how it should be done and when it should be done. While planning, management accountant uses various techniques such as budgeting, standard costing, marginal costing etc for fixing targets. For example, if a firm determines to achieve a particular level of profit, it has to plan how to reach the target. What products are to be sold and at what prices? The Management Accountant develops the data that helps managers to identify more profitable products. What are the different ways to improve the existing profits by 25%? Management Accounting throws various alternatives to achieve the goal.
- (2) **Organising:** Organising is a process of establishing the organizational framework and assigning responsibility to people working in the organization for achieving business goals and objectives. The organizational structure may not be the same in all organizations, some may have centralized, while others may be decentralized structures. The management accountant may prepare reports on product lines, based on which managers can decide whether to add or eliminate a product line in the current product mix.
- (3) **Controlling:** Control is the process of monitoring, measuring, evaluating and correcting actual results to ensure that a firm's goals and plans are achieved. Control is achieved through the process of feedback. Feedback allows the managers to allow the operations continue as they are or take corrective action, by some rearranging or correcting at midstream. The use of performance and control reports serve the function of controlling. For example, a production supervisor may receive weekly or daily performance reports, comparing actual material cost with planned costs. Significant variances can be isolated for corrective action. In the normal course, periodical reports are submitted, appraising the performance against the targets set. Reports for action are given to the top management, following the principle of management by exception. Performance and control reports do not tell managers what to do. These feedback reports identify, where attention is needed to help managers to determine the required course of action.
- (4) **Decision-making:** Decision-making is a process of choosing among competing alternatives. Decision-making is inherent in all the above three functions of management-planning, organizing and controlling. There may be different methods or objectives. The manager can plan or choose only one of the competing plans. Similarly, in organizing, decision can be made whether the organizational structure should be centralized or decentralized. In control function, manager can decide whether variance is worthy to investigate or not.
- (5) **Staffing:** Staffing is the process of recruitment, selection, development, training, compensation and overseeing employee in an organisation. Staffing, like all other managerial functions, is the duty which is vest on the management to perform. The role of the management accounting in this regard is manning the entity structure through proper and effective selection, appraisal, and development of the personnel to fill the role assigned to the employer. Moreover, the management accountants have to reduce the labour turnover and to control the overall employee cost.

## 1.5 FUNCTIONS OF MANAGEMENT ACCOUNTING

The primary objective of Management Accounting is to maximize profits or minimize losses. This is done through the presentation of statements in such a way that the management is able to take corrective policy or decision. The manner in which the Management Accountant satisfies the various needs of management is described as follows:

- (1) **Storehouse of Reliable Data:** Management wants reliable data for Planning, Forecasting and Decision-making. Management accounting collects the data from various sources and stores the



information for appropriate use, as and when needed. Though the main source of data is financial statements, Management Accounting is not restricted to the use of monetary data only. While preparing a sales budget, the management accountant uses the past data of the products sold from the financial records and makes projections based on the consumer surveys, population figures and other reliable information to estimate the sales budget. So, management accounting uses qualitative information, unlike financial accounting, for preparing its reports, collecting and modifying the data for the specific purpose.

- (2) **Modification and Presentation of Data:** Data collected from financial statements and other sources is not readily understandable to the management. The data is modified and presented to the management in such a way that it is useful to the management. If sales data is required, it can be classified according to product, geographical area, season-wise, type of customers and time taken by them for making payments. Similarly, if production figures are needed, these can be classified according to product, quality, and time taken for manufacturing process. Management Accountant modifies the data according to the requirements of the management for each specific issue to be resolved.
- (3) **Communication and Coordination:** Targets are communicated to the different departments for their achievement. Coordination among the different departments is essential for the success of the organisation. The targets and performances of different departments are communicated to the concerned departments to increase the efficiency of the various sections, thereby increasing the profitability of the firm. Variance analysis is an important tool to bring the necessary matters to the attention of the concerned to exercise control and achieve the desired results.
- (4) **Financial Analysis and Interpretation:** Management accounting helps in strategic decision making. Top managerial executives may lack technical knowledge. For example, there are various alternatives to produce. There is always a choice for the sales mix. Management 344 Accounting for Managers Accountant gives facts and figures about various policies and evaluates them in monetary terms. He interprets the data and gives his opinion about various alternative courses of action so that it becomes easier to the management to take a decision.
- (5) **Control:** It is absolutely essential that there should be a system of monitoring the performance of all divisions and departments so that deviations from the desired path are brought to light, without delay and are corrected then and there. This process is termed as control. The aim of this function 'control' is to facilitate accomplishment of the goals in an efficient manner. For the discharge of this important function, management accounting provides meaningful information in a systematic and effective manner. However, the role of accountant is misunderstood. Many consider the accountant as a controller of their performance. Many accountants themselves misunderstand their own role as controllers. The real role of control is effective communication and assists the managers in achieving their goals, as efficiently as possible.
- (6) **Supplying Information to Various Levels of Management:** Every level of management requires information for decision-making and policy execution. Top-level management takes broad policy decisions, leaving day-to-day decisions to lower management for execution. Supply of right information, at proper time, increases efficiency at all levels. The MIS provides relevant and timely information related to both internal and external to the organisation to enable management at all levels to take decisions. Decisions include cost optimisation, price fixation, implementation of any plan related with product, process, marketing etc.
- (7) **Reporting to Management:** Reporting is an important function of management accounting to achieve the targets. The reports are presented in the form of graphs, diagrams and other statistical techniques so as to make them easily understandable. These reports may be monthly, quarterly, and half-yearly. These reports are helpful in giving constant review of the working of the business.

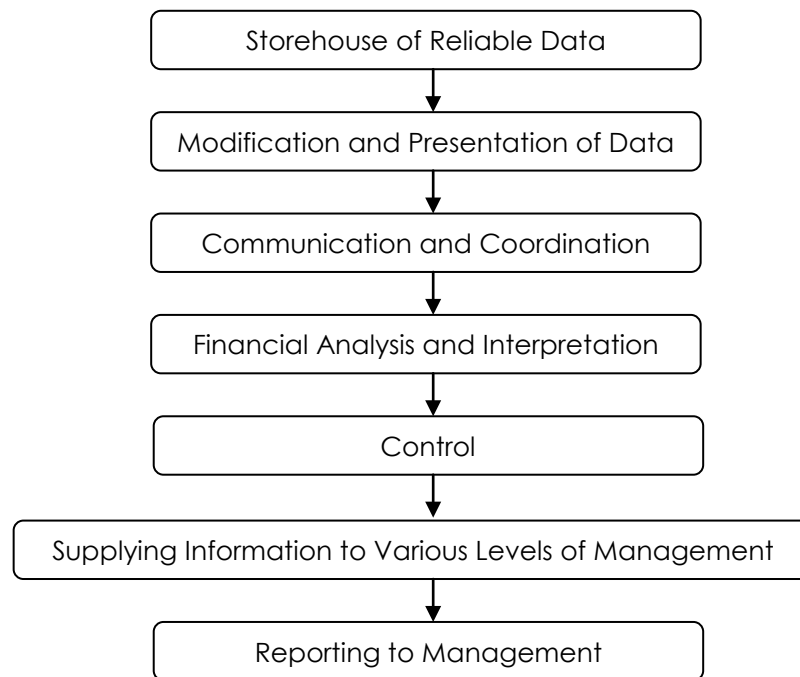

## 1.6 SIGNIFICANCE OF MANAGEMENT ACCOUNTING

The various advantages that accrue out of management accounting are enumerated below:

- (1) **Delegation of Authority:** Now a day the function of management is no longer personal, management accounting helps the organisation in proper delegation of authority for the attainment of the vision and mission of the business.
- (2) **Need of the Management:** Management Accounting plays the role in meeting the need of the management
- (3) **Qualitative Information:** Management Accounting accumulates the qualitative information so that management would concentrate on the actual issue to deliberate and attain the specific conclusion even for the complex problem.
- (4) **Objective of the Business:** Management Accounting provides measure and reports to the management thereby facilitating in attainment of the objective of the business.

## 1.7 LIMITATIONS OF MANAGEMENT ACCOUNTING

Despite the development of Management Accounting as an effective discipline to improve the managerial performance, some of the limitations are as under:

- (1) **Accuracy is not Ensured:** Management Accounting is largely based on estimates. It does not deal with actual, alone, and thus total accuracy is not ensured under Management Accounting.
- (2) **A Tool in the Hands of Management:** Management Accounting is definitely a tool in the hands of management, but cannot replace management.





- (3) **Strength and Weakness:** Management Accounting derives information from Financial Accounting, Cost Accounting and other records. The strength and weakness of these basic information providers become the strength and weakness of Management Accounting too.
- (4) **Costly Affair:** The installation of Management Accounting is a costly affair so all the organizations, in particular, small firms cannot afford.
- (5) **Lack of Knowledge and Understanding:** The emergence of Management Accounting is the fusion of a number of subjects like statistics, economics, engineering and management theory. Any inadequate grounding in any one or more of the subjects is bound to have an unfavourable effect on the consideration and solution of the problems, relating to management performance.
- (6) **Evolutionary Stage:** Comparatively, Management Accounting is a new discipline and is still very much in a stage of evolution. Therefore, it comes across the same difficulties or obstacles, which a relatively new discipline has to face.
- (7) **Psychological Resistance:** Adoption of a system of Management Accounting brings about a radical change in the established pattern of the activity of the management personnel. It calls for rearrangement of personnel as well as their activities. This is bound to encounter opposition from some quarter or other.

## 1.8 RELATIONSHIP BETWEEN MANAGEMENT ACCOUNTING AND COST ACCOUNTING

### Relationship between Management Accounting and Cost Accounting:

Management Accounting is primarily concerned with the requirements of the management. It involves application of appropriate techniques and concepts, which help management in establishing a plan for reasonable economic objective. It helps in making rational decisions for accomplishment of management objectives. Any workable concept or techniques whether it is drawn from Cost Accounting, Financial Accounting, Economics, Mathematics and statistics, can be used in Management Accountancy. The data used in Management Accountancy should satisfy only one broad test. It should serve the purpose that it is intended for. A management accountant accumulates, summarises and analysis the available data and presents it in relation to specific problems, decisions and day-to-day task of management. A management accountant reviews all the decisions and analysis from management's point of view to determine how these decisions and analysis contribute to overall organisational objectives. A management accountant judges the relevance and adequacy of available data from management's point of view.

The scope of Management Accounting is broader than the scope of Cost Accountancy. In Cost Accounting, primary emphasis is on cost and it deals with its collection, analysis, relevance interpretation and presentation for various problems of management. Management Accountancy utilizes the principles and practices of Financial Accounting and Cost Accounting in addition to other management techniques for efficient operations of a company. It widely uses different techniques from various branches of knowledge like Statistics, Mathematics, Economics, Laws and Psychology to assist the management in its task of maximising profits or minimizing losses. The main thrust in Management Accountancy is towards determining policy and formulating plans to achieve desired objective of management. Management Accountancy makes corporate planning and strategy effective.

From the above discussion we may conclude that the Cost Accounting and Management Accounting are interdependent, greatly related and inseparable. However, the difference between Cost Accounting and Management Accounting is briefly discussed hereunder:

**Difference between Cost Accounting and Management Accounting**

Sl. No	Basis	Cost Accounting (CA)	Management Accounting (MA)
(i)	Nature	CA records the quantitative aspect only.	MA records both qualitative and quantitative aspect.
(ii)	Objective	CA records the cost of producing a product and providing a service.	MA provides information to management for planning and co-ordination.
(iii)	Area	CA deals with cost ascertainment only.	MA is wider in scope as it includes financial accounting, budgeting, taxation, planning etc.
(iv)	Recording of data	CA uses both past and present figures.	MA is focused with the projection of figures for future.
(v)	Development	Development of CA is related to industrial revolution.	MA has been developed in accordance to the need of modern business world.
(vi)	Rules and Regulation	CA follows certain principles and procedures for recording costs of different products.	MA does not follow any specific rules and regulations.

**GLOSSARY**

**Cost Accounting:** Cost Accounting is the process of accounting for cost which begins with the recording of income and expenditure or the bases on which they are calculated and ends with the preparation of periodical statements and reports for ascertaining and controlling costs.

**Financial Accounting:** Financial Accounting is the organisation and presentation of a firm's Accounts for information of the management as well as the various stakeholders.

**Management Accounting:** Management Accounting is the process of identification, measurement, accumulation, analysis, preparation, interpretation, and communications of financial information used by management to plan, evaluate, and exercise control within an organisation and to assure the appropriate use of and accountability for its resources.

**Self Learning Questions:**

1. Define management accounting and state its significance?
2. Discuss the role of management accounting in management process.
3. Describe the functions of management accounting.
4. List down the limitation of management accounting.
5. State the relationship between management accounting and cost accounting.
6. Discuss the main objectives of introduction of a Cost and Management Accounting System in a manufacturing organization.

**Multiple Choice Questions:**

1. Planning and control are done by
  - A. top management
  - B. lowest level of management
  - C. all levels of management
  - D. None of the above



2. Decision-making concerns the
  - A. Past
  - B. Future
  - C. Past and future both
  - D. None of the above
3. The comparison of actual results with expected results is referred to as
  - A. Feedback
  - B. Controlling
  - C. None
4. Decision-making is involved in the following function/s of management
  - A. Planning
  - B. Organizing
  - C. Controlling
  - D. All the above functions
5. Management Accounting function works like a policeman to ensure the performance of the employees:
  - A. Controlling
  - B. Planning
  - C. Organizing
  - D. None of these
6. The use of management accounting is
  - A. Compulsory
  - B. Optional
  - C. Mandatory as per the law
  - D. None of the above
7. Management Accounting relates to
  - A. Collection of data from different sources
  - B. Modification of data to meet the specific needs
  - C. Presentation of data
  - D. All of the above
8. Accounting is divided into
  - A. 2
  - B. 3
  - C. 4
  - D. None of the above

**[Ans: 1. (a) 2. (b) 3. (a) 4. (d) 5 (a) 6. (b) 7. (d) 8. (b)]**

**Match the followings:**

	Column A		Column B
1	Management Accounting is a tool to.	A	Effective and efficient
2	Management accounting is composed of.	B	Planning, Organising, Controlling and Decision making
3	Organisation has to be both	C	Maximisation of profit and minimisation of losses.
4	Objective of management Accounting	D	Management
5	Function of Management	E	Management and Accounting

**[Ans: D, E, A, C, B]****True or False:**

1. Any form of accounting, which enables a business to be conducted more efficiently can be regarded as Management Accounting.
2. Standard formats are used in management accounting for preparation of reports.
3. In Management Accounting, Generally Accepted Accounting Principles and Practices of Accounting govern the preparation of reports.
4. It is optional for a company to have financial accounting
5. Management Accounting reports are public documents

**[Ans: 1. True, 2. False, 3. False, 4. False, 5. False]****Fill in the blanks:**

1. Decision-making is a process of choosing among \_\_\_\_\_ alternatives.
2. Management Accounting tailors \_\_\_\_\_ information to meet the specific needs of management.
3. Management Accounting is \_\_\_\_\_ in its orientation.
4. The accounting information system for financial accounting and \_\_\_\_\_ accounting is same.
5. Management accounting a \_\_\_\_\_ tools to management.

**[Ans: Competing, Financial, Futuristic, Management, Modern]**



# Study Note - 2

## DECISION MAKING TOOLS



This Study Note includes:

- 2.1 Marginal Costing
- 2.2 Determination of Cost and Profit under Marginal Costing
- 2.3 Realities about Marginal Costing
- 2.4 Techniques of Marginal Costing
- 2.5 Differential Cost Analysis
- 2.6 Differences between Absorption Costing and Marginal Costing
- 2.7 Application of Marginal Costing in Decision Making
- 2.8 Transfer Pricing
- 2.9 Objectives of Inter Company Transfer Pricing
- 2.10 Methods of Transfer Pricing

### 2.1 MARGINAL COSTING

The cost of a product or process can be ascertained using different elements of cost using any of the following two techniques viz.,

1. Absorption Costing
2. Marginal Costing

#### Absorption Costing

Under this method, the cost of the product is determined after considering the total cost i.e., both fixed and variable costs. Thus this technique is also called traditional or total costing. The variable costs are directly charged to the products whereas the fixed costs are apportioned over different products on a suitable basis, manufactured during a period. Thus under absorption costing, all costs are identified with the manufactured products.

#### Limitations of Absorption Costing

1. Being dependent on levels of output which vary from period to period, costs are vitiated due to the existence of fixed overhead. This renders them useless for purposes of comparison and control. (If, however, overhead recovery rate is based on normal capacity, this situation will not arise).
2. Carryover of a portion of fixed costs, i.e., period costs to subsequent accounting periods as part of the cost of inventory is a unsound practice because costs pertaining to a period should not be allowed to be vitiated by the inclusion of costs pertaining to the previous period.
3. Profits and losses in the accounts are related not only to sales but also to production, including the product which is unsold. This is contrary to the principle that profits are made not at the stage when products are manufactured but only when they are sold.
4. There is no uniformity in the methods of application of overhead in absorption costing. These problems have, no doubt, to be faced in the case of marginal costing also but to a less extent of fixed overhead will not arise in the case of marginal costing.



5. Absorption costing is not always suitable for decision making solution to various types of problems of management decision making, where the absorption cost method would be practically ineffective, such as selection of production volume and optimum capacity utilization, selection of production mix, whether to buy or manufacture, choice of alternatives and evaluation of performance can be had with the help of marginal cost analysis. Sometimes, the conclusion drawn from absorption cost data in this regard may be misleading and lead to losses.

### **Marginal Costing**

Marginal costing is "the ascertainment of marginal costs and of the effect on profit of changes in volume or type of output by differentiating between fixed costs and variable costs." Several other terms in use like direct costing, contributory costing, variable costing, comparative costing, differential costing and incremental costing are used more or less synonymously with marginal costing.

It is a process whereby costs are classified into fixed and variable and with such a division so many managerial decisions are taken. The essential feature of marginal costing is division of total costs into fixed and variable, without which this could not have existed. Variable costs vary with volume of production or output, whereas fixed costs remains unchanged irrespective of changes in the volume of output. It is to be understood that unit variable cost remains same at different levels of output and total variable cost changes in direct proportion with the number of units. On the other hand, total fixed cost remains same disregard of changes in units, while there is inverse relationship between the fixed cost per unit and the number of units.

### **Features of Marginal Costing**

The main features of Marginal Costing may be summed up as follows:

1. Appropriate and accurate division of total cost into fixed and variable by picking out variable portion of semi variable costs also.
2. Valuation of stocks such as finished goods, work-in-progress is valued at variable cost only.
3. The fixed costs are written off soon after they are incurred and do not find place in product cost or inventories.
4. Prices are based on Marginal Cost and Marginal Contribution.
5. It combines the techniques of cost recording and cost reporting.
6. Fixed costs are treated as period costs and charged to profit and loss account for the period for which they are incurred.
7. Profitability of departments and products is determined with reference to their contribution margin.

### **Advantages or Merits or Applications of Marginal Costing**

1. Marginal costing system is simple to operate than absorption costing because they do not involve the problems of overhead apportionment and recovery.
2. Marginal costing avoids, the difficulties of having to explain the purpose and basis of overhead absorption to management that accompany absorption costing. Fluctuations in profit are easier to explain because they result from cost volume interactions and not from changes in inventory valuation.
3. It is easier to make decisions on the basis of marginal cost presentations, e.g., marginal costing shows which products are making a contribution and which are failing to cover their avoidable (i.e., variable) costs. Under absorption costing the relevant information is difficult to gather, and there is the added danger that management may be misled by reliance on unit costs that contain an element of fixed cost.



4. Marginal costing is essentially useful to management as a technique in cost analysis and cost presentation. It enables the presentation of data in a manner useful to different levels of management for the purpose of controlling costs. Therefore, it is an important technique in cost control.
5. Future profit planning of the business enterprises can well be carried out by marginal costing. The contribution ratio and marginal cost ratios are very useful to ascertain the changes in selling price, variable cost etc. Thus, marginal costing is greatly helpful in profit planning.
6. When a business concern consists of several units and produces several products and evaluation of performance of such components can well be made with the help of marginal costing.
7. It is helpful in forecasting.
8. When there are different products, the determination of number of units of each product, called Optimum Product Mix, is made with the help of marginal costing.
9. Similarly, optimum sales mix i.e., sales of each and every product to get maximum profit can also be determined with the help of marginal costing.
10. Apart from the above, numerous managerial decisions can be taken with the help of marginal costing, some of which, may be as follows:-
  - (a) Make or buy decisions,
  - (b) Exploring foreign markets,
  - (c) Accept an order or not,
  - (d) Determination of selling price in different conditions,
  - (e) Replace one product with some other product,
  - (f) Optimum utilisation of labour or machine hours,
  - (g) Evaluation of alternative choices,
  - (h) Subcontract some of the production processes or not,
  - (i) Expand the business or not,
  - (j) Diversification,
  - (k) Shutdown or continue.

### **Limitations of Marginal Costing**

- (a) The separation of costs into fixed and variable present's technical difficulties and no variable cost is completely variable nor is a fixed cost completely fixed.
- (b) Under the marginal cost system, stock of finished goods and work-in-progress are understated. After all, fixed costs are incurred in order to manufacture products and as such, these should form a part of the cost of the products. It is, therefore, not correct to eliminate fixed costs from finished stock and work-in-progress.
- (c) The exclusion of fixed overhead from the inventories affects the Profit and Loss Account and produces an unrealistic and conservative Balance Sheet, unless adjustments are made in the financial accounts at the end of the period.
- (d) In marginal costing system, marginal contribution and profits increase or decrease with changes in sales volume. Where sales are seasonal, profits fluctuate from period to period. Monthly operating statements under the marginal costing system will not, therefore, be as realistic or useful as in absorption costing.



- (e) During the earlier stages of a period of recession, the low profits or increase in losses, as revealed in a magnified way in the marginal costs statements, may unduly create panic and compel the management to take action that may lead to further depression of the market.
- (f) Marginal costing does not give full information. For example, increased production and sales may be due to extensive use of existing equipments (by working overtime or in shifts), or by an expansion of the resources, or by the replacement of labour force by machines. The marginal contribution fails to reveal these.
- (g) Though for short-term assessment of profitability marginal costs may be useful, long term profit is correctly determined on full costs basis only.
- (h) Although marginal costing eliminates the difficulties involved in the apportionment and under and over-absorption of fixed overhead, the problem still remains so far as the variable overhead is concerned.
- (i) With increased automation and technological developments, the impact on fixed costs on products is much more than that of variable costs. A system which ignores fixed costs is therefore, less effective because a major portion of the cost, such as not taken care of.
- (j) Marginal costing does not provide any standard for the evaluation of performance. A system of budgetary control and standard costing provides more effective control than that obtained by marginal costing.

## 2.2 DETERMINATION OF COST AND PROFIT UNDER MARGINAL COSTING

For the determination of cost of a product or service under marginal costing, costs are classified into variable and fixed. All the variable costs are part of product and services while fixed costs are charged against contribution margin.

### Cost and Profit Statement under Marginal Costing

Particulars		Amount (₹)	Amount (₹)
Sales Revenue	(A)		----
<b>Product Cost:</b>			
Direct Materials		----	
Direct Labour		----	
Direct Expenses		----	
Variable manufacturing overheads		----	
<b>Total Product Costs</b>	(B)	-----	----
<b>Product Contribution Margin (A – B)</b>			----
Variable Administration overheads		----	
Variable Selling & Distribution overheads		----	----
<b>Contribution Margin</b>	(C)		----
<b>Period Cost:</b>	(D)		
Fixed manufacturing expenses		----	
Fixed non- manufacturing expenses		----	----
<b>Profit/(Loss) (C – D)</b>			----





### 2.3 REALITIES ABOUT MARGINAL COSTING

Some of the realities marginal costing are discussed below:

Marginal costing is not a distinct method of costing like job costing, process costing, operating costing, etc., but a special technique used for managerial decision making. Marginal Costing is used to provide a basis for the interpretation of cost data to measure the profitability of different products, processes and cost centres in the course of decision making. It can, therefore, be used in conjunction with the different methods of costing such as job costing, process costing and with other techniques like standard costing or budgetary control.

In marginal costing, cost ascertainment is made on the basis of the nature of cost. It gives consideration to behaviour of costs. In other words, the technique has developed from a particular conception and expression of the nature and behaviour of costs and their effect upon the profitability of an undertaking.

Under the total cost method the total cost is the sum total of the cost of direct material, direct labour, direct expenses, manufacturing overheads, administration overheads, selling and distribution overheads. In this system, other things being equal, the total cost per unit will remain constant only when the level of output or mixture is the same from period to period. Since these factors are continually fluctuating, the actual total cost will vary from one period to another. This situation arises because of changes in volume of output and the peculiar behaviour of fixed expenses included in the total cost. Such fluctuating manufacturing activity, and consequently the variations in the total cost from period to period poses a serious problem to the management in taking sound decisions. Therefore, the application of marginal costing has been given wide recognition in the field of decision making.

### 2.4 TECHNIQUES OF MARGINAL COSTING

#### Contribution:

In common parlance, contribution is the reward for the efforts of the entrepreneur or owner of a business concern. From this, one can get in his mind that contribution means profit. But it is not so. Technically or in Costing terminology, contribution means not only profit but also fixed cost. That is why; it is defined as the amount recovered towards fixed cost and profit.

Contribution or contribution margin is the difference between sales revenue and total variable costs irrespective of manufacturing or non-manufacturing.

Contribution (C) = Sales revenue (S) – Total Variable Cost (V)

Contribution can be computed by subtracting variable cost from sales or by adding fixed costs and profit.

Symbolically,  $C = S - V \rightarrow (1)$

Where C = Contribution

S = Selling Price

V = Variable Cost

Also  $C = F + P \rightarrow (2)$

Where F = Fixed Cost

P = Profit



From (1) and (2) above, we may deduce the following equation called Fundamental Equation of Marginal Costing i.e.,  $S - V = F + P \rightarrow (3)$

Contribution is helpful in determination of profitability of the products and / or priorities for profitabilities of the products. When there are two or more products, the product having more contribution is more profitable.

For example: The following are the three products with selling price and cost details:

Particulars	A	B	C
Selling Price (₹)	100	150	200
Variable Cost (₹)	50	70	100
Contribution (₹)	50	80	100

In the above example, one can say that the product 'C' is more profitable because, it has more contribution. This proposition of product having more contribution is more profitable is valid, as long as, there are no limitations on any factor of production. In this context, factors of production means, the factors that are responsible for producing the products such as materials, labour, machine hours, demand for sales etc.,

### Limiting Factor (or) Key Factor

**Limiting Factor (or) Key Factor or principal Budget Factor:** CIMA – London terminology defines a key factor or limiting factor or principal budget factor as a factor which at a particular time or over a period will limit the activities of an organisation and which is therefore, taken into account in preparing budgets.

In the above example, we find that product having more contribution is more profitable. However, when there is a limitation on any input factor, the profitability of the product cannot simply be determined by finding out the contribution of the unit, but it can be found out by ascertaining the contribution per unit of that factor of production which is limited in the given situation. Such factor of production which is limited in the question is called key factor or limiting factor.

Continuing the above example, it may be explained as follows:

The three products take some raw material. A takes 1 kg, B requires 2 kgs, C requires 5 kgs and the raw material is not abundant.

Then profitability of the above products is determined as follows:

$$\text{Profitability} = \frac{\text{Contribution}}{\text{Key Factor}}$$

A	B	C
$50 / 1 = ₹ 50$	$80 / 2 = ₹ 40$	$100 / 5 = ₹ 20$

Now, product A is more profitable because it has more contribution per kg of material.

Key factor can also be called as scarce factor or Governing factor or Limiting factor or Constraining factor etc., whatever may be the name, it indicates the limitation on the particular factor of production.

From the above, it is essentially understandable that contribution is helpful in determination of profitability of the products, priorities for profitability of the product and in particular, profitabilities when there are limitation on any factor.



### Profit Volume Ratio (P/V Ratio) or contribution Ratio

Profit Volume Ratio (P/V Ratio) or Contribution Ratio is the ratio of Contribution to Sales.

#### For Example:

**Gross Profit Ratio:** It may be expressed as follows:

- Gross profit is ¼th of sales
- Sales is 4 times that of gross profit
- Gross profit ratio is 25%
- Gross profit is 0.25 of sales and lastly
- Gross profit and sales are in the ratio of 1 : 4

Symbolically, P/V ratio =  $\left(\frac{\text{Contribution}}{\text{Sales}}\right) \times 100 \rightarrow (1)$

- P/V ratio =  $\left(\frac{C}{S} \times 100\right)$
- Contribution = Sales  $\times$  P/V ratio  $\rightarrow (2)$
- Sales =  $\left(\frac{\text{Contribution}}{\text{P/V Ratio}}\right) \rightarrow (3)$

When cost accounting data is given for two periods, then:

P/V ratio =  $\left(\frac{\text{Change in Contribution}}{\text{Change in Sales}} \times 100\right)$  or

P/V ratio =  $\left(\frac{\text{Change in Profit}}{\text{Change in Sales}} \times 100\right)$

It is to be noted that the above two formulas are valid as long as there are no changes in prices, means input prices and selling prices.

Usually, Sales = Cost + Profit.

i.e., it can also be written as Sales = Variable Cost + Fixed Cost + Profit and this is called general sales equation.

Since Sales consists of variable costs and contribution, given the variable cost ratio, P/V ratio can be found out. Similarly, given the P/V ratio, variable cost ratio can be found out.

**For example,** P/V ratio is 40%, then variable cost ratio is 60%, given variable cost ratio is 70%, then P/V ratio is 30%. Such a relationship is called complementary relationship. Thus P/V ratio and variable cost ratios are said to be complements of each other.

P/V ratio is also useful like contribution for determination of profitabilities of the products as well as the priorities for profitabilities of the products. In particular, it is useful in determination of profitabilities of the



products in the following two situations:

- (i) When sales potential in value is limited.
- (ii) When there is a greater demand for the products.

### Break Even Analysis

Break-even Analysis is a method for examining the relationship between sales revenue, variable costs and fixed costs to determine the minimum value of production necessary to break-even.

Break Even means the volume of production or sales where there is no profit or loss. In other words, Break Even Point is the volume of production or sales where total costs are equal to revenue. It helps in finding out the relationship of costs and revenues to output. In understanding the breakeven point, cost, volume and profit are always used. The break even analysis is used to answer many questions of the management in day to day business.

The formal break even chart is as follows:

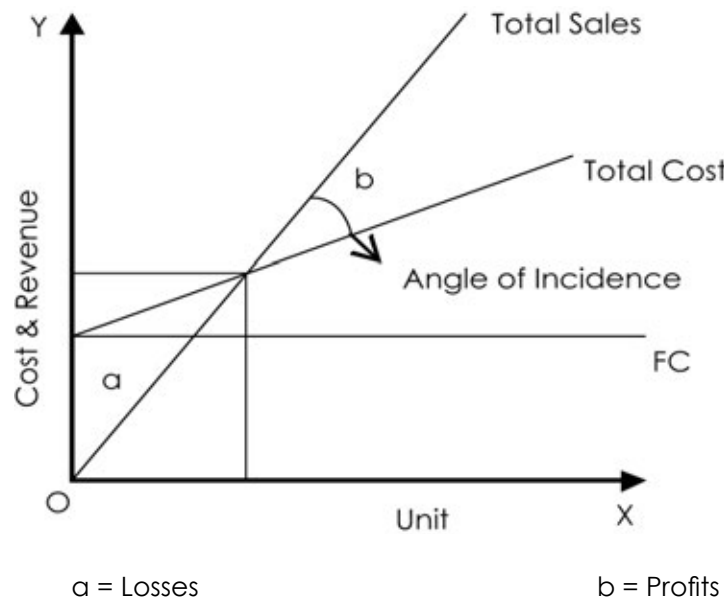

When no. of units are expressed on X-axis and costs and revenues are expressed on Y-axis, three lines are drawn i.e., fixed cost line, total cost line and total sales line. In the above graph we find there is an intersection point of the total sales line and total cost line and from that intersection point if a perpendicular is drawn to X-axis, we find break even units. Similarly, from the same intersection point a parallel line is drawn to X-axis so that it cuts Y-axis, where we find Break Even point in terms of value. This is how, the formal pictorial representation of the Break Even chart.

At the intersection point of the total cost line and total sales line, an angle is formed called Angle of Incidence, which is explained as follows:

### Contribution Break-Even Chart

A contribution breakeven chart is based on the same principles as a conventional breakeven chart except for that it shows the variable cost line instead of the fixed cost line. Lines for total cost and sales revenue remain the same. The breakeven point and profit can be read in the same way as with a conventional chart. It is also possible to read the contribution for any level of activity.

Contribution breakeven chart is shown below:

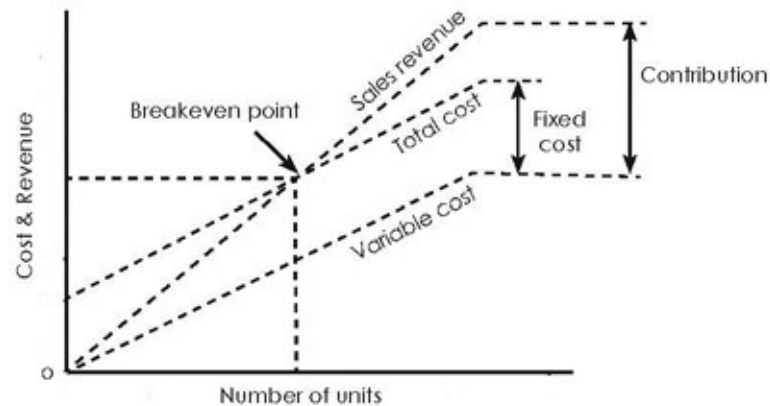

The contribution can be read as the difference between the sales revenue line and the variable cost line.

### Angle of Incidence

Angle of Incidence is the angle between sales and total cost line. This angle is an indicator of profit-earning capacity of the firm over the breakeven point sales.

Angle of Incidence is an angle formed at the intersection point of total sales line and total cost line in a formal break even chart. If the angle is larger, the rate of growth of profit is higher and if the angle is lower, the rate of growth of profit is lower. So, growth of profit or profitability rate is depicted by Angle of Incidence.

### Cost-Volume-Profit Analysis (CVP analysis)

Cost-Volume-Profit (CVP) Analysis is a technique for evaluating the relationship between costs, volume and profit. From the breakeven charts breakeven point and profits at a glance can be found out. Besides, management makes profit planning with the help of breakeven charts. It can clearly be understood by way of charts to know the changes in profit due to changes in costs and output. Such profit planning is made with the variables mainly cost, profit and volume, such an analysis is called breakeven analysis. Throughout the charts relationship is established among the cost, volume and profit, it is also called Cost-Volume-Profit Analysis (CVP analysis). **Cost-volume-profit analysis, break even analysis and profit graphs are interchangeable words.**

### Importance

It provides the information about the following matters:

- (i) The behaviour of cost in relation to volume
- (ii) Volume of production or sales, where the business will break-even
- (iii) Sensitivity of profit due to variation in output
- (iv) Amount of profit for a projected sales volume
- (v) Quantity of production and sales for a target profit level

### Impact of various changes on profit

An understanding of CVP analysis is extremely useful to management in budgeting and profit planning. It explains the impact of the following on the net profit.

- (i) Changes in selling prices,
- (ii) Changes in volume of sales,



- (iii) Changes in variable cost,
- (iv) Changes in fixed cost.

The change in profit can be studied through Break even charts in different situations in the following manner:

**(i) Increase in No. of Units**

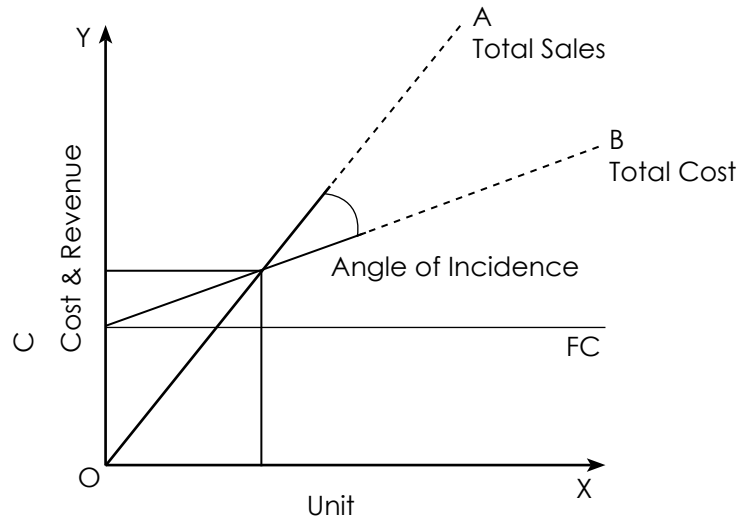

'CB and OA' lines indicate increase in total cost and total sales. In the above chart, if we clearly observe we find that there is no change in BEP even if there is increase or decrease in No. of units.

**(ii) Increase in Sales due to increase in selling price.**

NTS = New Total Sales line

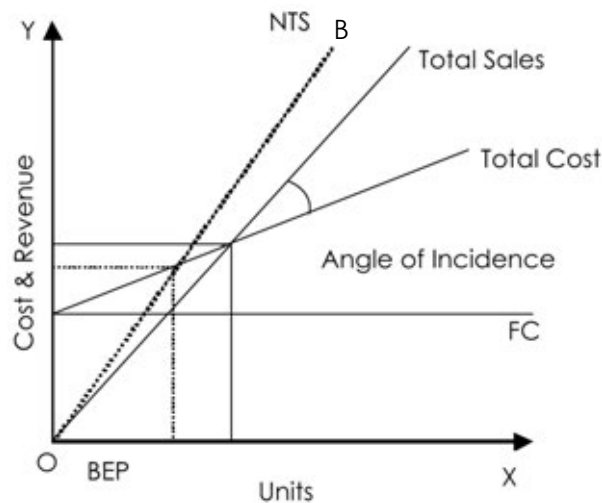

'OB' line indicates changes in breakeven point and changes in sales.

From the above chart, we observe that profit is increased by increasing the selling price and also, if there is change in selling price, BEP also changes. If selling price is increased then BEP decreases. If selling price is decreased then BEP increases. Thus, we say that there is an inverse relationship between selling price and BEP.

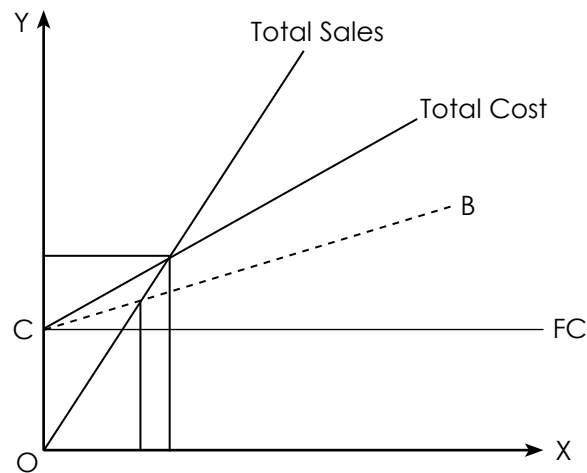
**(iii) Decrease in variable cost:**

'CB' line indicates decrease in total cost and decrease in B.E.P

From the above chart, we observe that when variable costs are decreased, no doubt, profit is increased. If there is change in variable cost then BEP also changes. If variable cost is decreased then BEP also decreases. If variable cost is increased then BEP also increases. Thus there is direct relationship between variable cost and BEP.

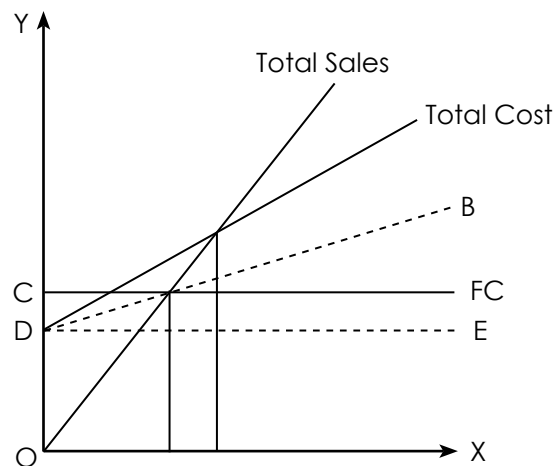
**(iv) Change in fixed cost:**

'DE and DB' line indicate decrease in fixed cost and total cost respectively and consequent decrease in BEP.

From the above chart also we find that there is increase in profit due to decrease in fixed cost. If fixed cost is increased then BEP also increases. If fixed cost is decreased then BEP also decreases. Thus there is a direct relationship between fixed cost and BEP.

**Non linear Break Even Chart:**

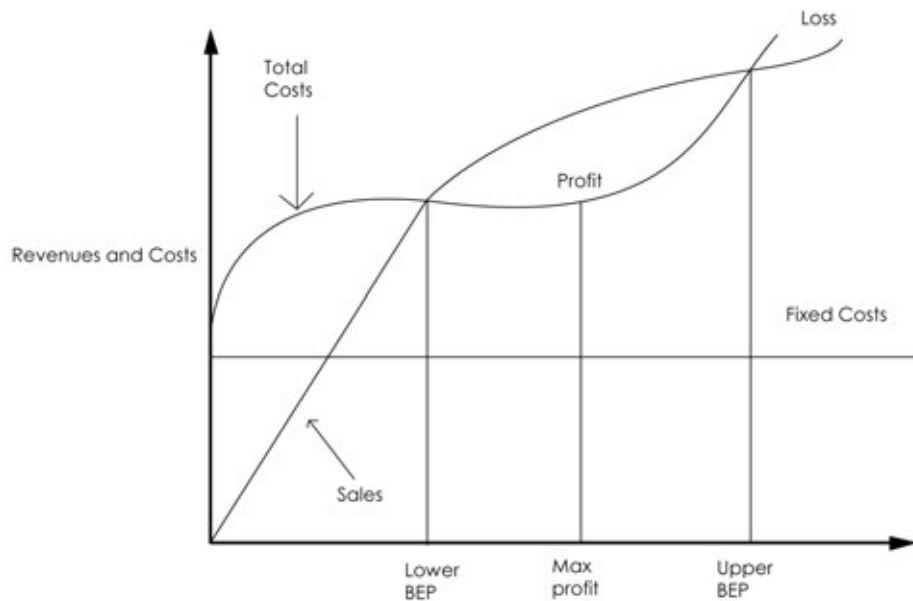

In some cases on account of non-linear behaviour of cost and sales there may be two or more break even points. In such a case the optimum profit is earned where the difference between the sales and the total costs is the largest. It is obvious that the business should produce only upto this level. This is being illustrated in the above chart.

**Cash Break-Even Point**

When break-even point is calculated only with those fixed costs which are payable in cash, such a break-even point is known as cash break-even point. This means that depreciation and other non-cash fixed costs are excluded from the fixed costs in computing cash break-even point. Its formula is-

$$\text{Cash breakeven point} = \text{Cash fixed costs} / \text{Contribution per unit.}$$

**Illustration 1**

ABC Ltd. sold ₹2,75,000 units of its product at ₹37.50 per unit. Variable costs are ₹17.50 per unit (manufacturing costs of ₹14 and selling cost ₹3.50 per unit). Fixed costs are incurred uniformly throughout the year and amount to ₹35,00,000 (including depreciation of ₹15,00,000). There is no beginning or ending inventories.

**Required:**

- (i) Estimate break-even sales level quantity and cash break-even sales level quantity.

**Solution:**

(i) Break -even Sales Quantity = Fixed cost /Contribution margin per unit  
 = ₹35,00,000/ ₹20 = 1,75,000 units

Cash Break-even sales Quantity = Cash Fixed Cost / Contribution margin per unit  
 = ₹20,00,000/ ₹20 = 1,00,000 units.



## Profit Volume Chart

Profit volume chart is the chart that shows the relationship between profit and sales volume.

The normal break-even charts suffer from one limitation. Profit cannot be read directly from the chart. It is essential to deduct total cost from sale to know the profit figure. The profit graph overcomes the difficulty by plotting profit directly against an activity. These charts are easy to understand and their preparation involves drawing sales curve and profit curve. The point at which profit line cuts the sales line is called break-even point. Taking the methods and objects under consideration, the profit-volume chart can be further divided into following categories i.e.,

(a) Simple Profit-Volume Chart:

Its preparation involves the following steps:

1. Finding out profit at any two levels of activity,
2. Drawing sales line,
3. Drawing profit line,

Simple Profit-Volume chart is shown below:

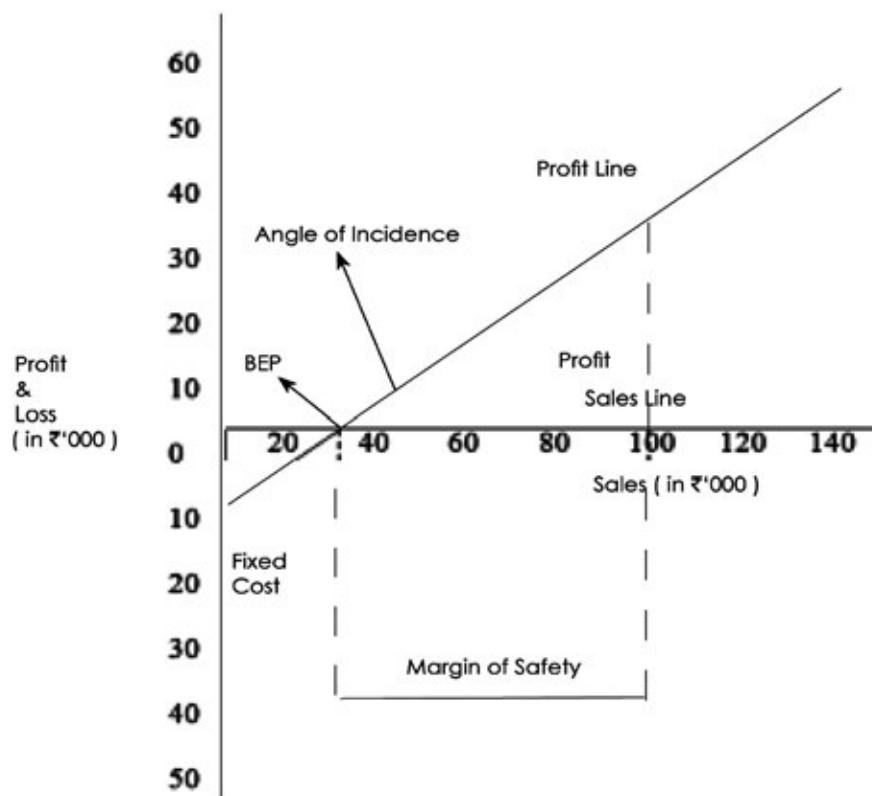

b. Profit volume chart showing different breakeven point at different price levels is shown below:

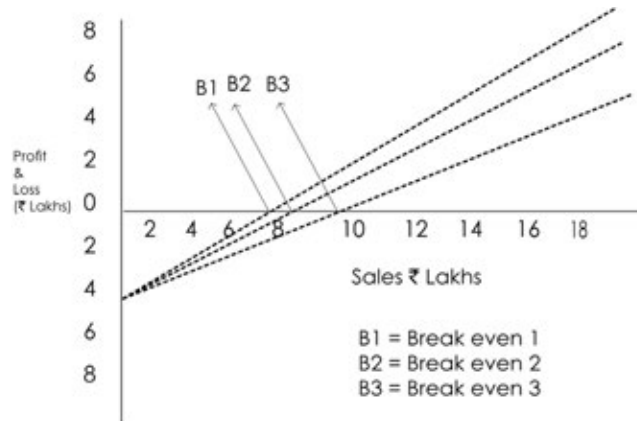

### Sequential Profit Graph

Sometimes, a company manufactures more than one product of varying profitability. A change in the profitability of one product will lead to a change in the profitability as a whole. Profit-volume chart can be prepared for a group also. This chart shows relative profitability of different products. It is also called profit-volume graph for a group of products, sequential profit graph or profit path chart. Its main advantage is that it exhibits the relative profitability of different products at a glance. This graph is also useful to show average slope and marginal slope.

Methods of drawing 'Profit Path':

In sequential profit graph or profit graph for a group of products, a line "profit plan" is drawn in order to draw total profit line. For drawing profit path, a statement is prepared showing cumulative sale and cumulative profit. The line 'Profit path' is drawn with the aid of columns for cumulative same and cumulative profit.

Steps in drawing Profit volume graph (or) sequential profit graph:

1. Prepare a marginal cost statement to know the P/V ratios.
2. Prepare a statement to find out cumulative sale and cumulative profit.
3. Draw a profit path with the help of columns, cumulative sale and cumulative profit.
4. Draw total profit line for group of products.

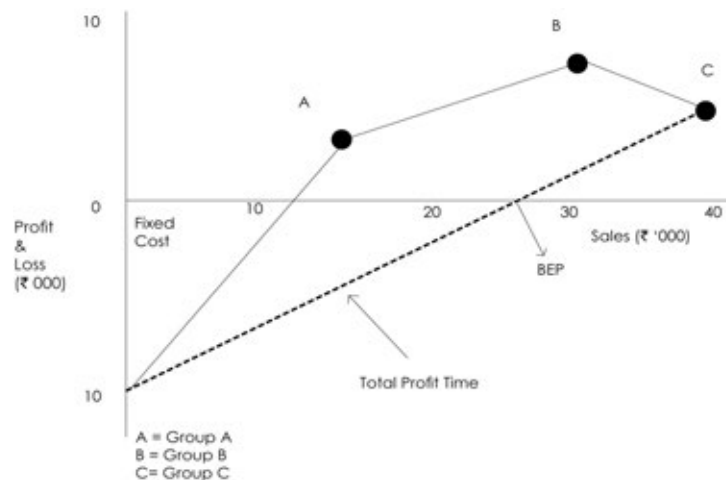

**COMPUTATION OF BREAK EVEN POINT**

$$\text{Break Even Point in value} = \frac{F \times S}{S - V} \quad \dots (1)$$

$$= \frac{F \times S}{C} \quad \dots (2)$$

$$= \frac{F \times S}{S + P} \quad \dots (3)$$

$$= \frac{F}{\text{P.V. Ratio}} \quad \dots (4)$$

$$\text{Or} = \frac{F}{\frac{C}{S}}$$

$$\text{Or} = \frac{F}{\frac{S - V}{S}}$$

$$= \frac{F}{1 - \frac{V}{S}} \quad \dots (5)$$

Break Even Point (in units) = Fixed Cost / Contribution per unit

**Proof for basic breakeven**

Let, V be the variable cost per unit

U be the volume of output i.e., No. of units

P be the Profit

F be the Fixed Cost

S be the Selling Price

By substituting the notations in general sales equation:

Sales = Fixed cost + Variable cost + Profit

$$SU = F + VU + P$$

At Break Even, SU = F + VU (Since P = 0)

$$\rightarrow SU - VU = F$$

$$\rightarrow U(S - V) = F$$

$$\rightarrow U = \frac{F}{S - V}$$

OR

No. of Units Contribution per Unit  $\frac{\text{Fixed Cost}}{\text{Contribution Per Unit}}$

Break even sales

$$SU (\text{Sales}) = \frac{F \times S}{S - V}$$

Where,

F = Fixed Cost

V = Variable Cost

S = Sales

P = Profit

C = Contribution



### **Uses and applications of Break even Analysis (Or) Profit Charts (Or) Cost Volume Profit Analysis**

The important uses to which cost-volume profit analysis or break-even analysis or profit charts may be put to use are:

- (a) Forecasting costs and profits as a result of change in Volume determination of costs, revenue and variable cost per unit at various levels of output.
- (b) Fixation of sales Volume level to earn or cover given revenue, return on capital employed, or rate of dividend.
- (c) Determination of effect of change in Volume due to plant expansion or acceptance of order, with or without increase in costs or in other words, determination of the quantum of profit to be obtained with increased or decreased volume of sales.
- (d) Determination of comparative profitability of each product line, project or profit plan.
- (e) Suggestion for shift in sales mix.
- (f) Determination of optimum sales volume.
- (g) Evaluating the effect of reduction or increase in price, or price differentiation in different markets.
- (h) Highlighting the impact of increase or decrease in fixed and variable costs on profit.
- (i) Studying the effect of costs having a high proportion of fixed costs and low variable costs and vice-versa.
- (j) Inter-firm comparison of profitability.
- (k) Determination of sale price which would give a desired profit for break-even.
- (l) Determination of the cash requirements as a desired volume of output, with the help of cash breakeven charts.
- (m) Break-even analysis emphasising the importance of capacity utilisation for achieving economy.
- (n) The comparative effects of a shutdown or continued operation at a loss indicated during severe recession.
- (o) The effect on total cost of a change in the fixed overhead more clearly demonstrated through break-even charts.

### **Limitations of Break-even Analysis**

- (a) Costs are either fixed or variable and all costs are clearly segregated into their fixed and variable elements. This cannot possibly be done accurately and the difficulties and complications involved in such segregation make the break-even point inaccurate.
- (b) The behavior of both costs and revenue is not entirely related to changes in volume.
- (c) Costs and revenue patterns are linear over levels of output being considered. In practice, this is not always so and the linear relationship is true only within a short run relevant range.
- (d) Fixed costs remain constant and variable costs vary in proportion to the volume. Fixed costs are constant only within a limited range and are liable to change at varying levels of activity and also over a long period, particularly when additional plants and equipments are introduced.
- (e) Sales mix is constant or only one product is manufactured. A combined analysis taking all the products of the mix does not reflect the correct position regarding individual products.
- (f) Production and sales figures are identical or the change in opening and closing stocks of the finished product is not significant.



- (g) The units of production on the various product range are identical. Otherwise, it is difficult to find a homogeneous factor to represent volume.
- (h) The activities and productivity of the concern remain unchanged during the period of study.
- (i) As output is continuously varied within a limited range, the contribution margin remains relatively constant. This is possible mainly where the output is more or less homogeneous as in the case of process industries

## 2.5 DIFFERENTIAL COST ANALYSIS

Differential Cost is the change in the costs which results from the adoption of an alternative course of action. The alternative actions may arise due to change in sales volume, price, product mix (by increasing, reducing or stopping the production of certain items), or methods of production, sales, or sales promotion, or they may be due to 'make or buy' or 'take or refuse' decisions. When the change in costs occurs due to change in the activity from one level to another, differential cost is referred to as incremental cost or decremental cost, if a decrease in output is being considered, i.e. total increase in cost divided by the total increase in output. However, accountants generally do not distinguish between differential cost and incremental cost and the two terms are used to mean one and the same thing.

The computation of differential cost provides an useful method of analysis for the management for anticipating the results of any contemplated changes in the level or nature of activity. When policy decisions have to be taken, differential costs worked out on the basis of alternative proposals are of great assistance.

The determination of differential cost is simple. Differential cost represents the algebraic difference between the relevant costs for the alternatives being considered. Thus, when two levels of activities are being considered, the differential cost is obtained by subtracting the cost at one level from the cost of another level.

### **The essential features of differential costs are as follows:-**

- 1) The basis data used for differential cost analysis are costs, revenue and the investment factors which are relevant in the problem for which the analysis is undertaken.
- 2) Total differential costs rather than the costs per unit are considered.
- 3) Differential cost analysis is made outside the accounting records.
- 4) As the differences in the costs at two levels are considered, absolute costs at each level are not as relevant as the difference between the two. Thus, items of costs which do not change but are identical for the alternatives under consideration, are ignored.
- 5) The differentials are measured from a common base point or position.
- 6) The stage at which the difference between the revenue and the cost is the highest, measured from the common base point, determines the choice from amongst a number of alternative actions.
- 7) In computing differential costs, historical or standard costs may be used but they should be adjusted to the requirements of future conditions.
- 8) The elements and items of cost to be considered in differential cost analysis will depend upon the nature of the problem and the alternatives being considered.

### **Differential Costs Analysis and Marginal Costing**

Although the techniques of differential costs analysis are similar to those of marginal costing, the two should not be confused. The points of similarity and difference between differential costs analysis and marginal costing are summarized below:



### Similarity

- (a) Both the techniques of cost analysis and cost presentation.
- (b) Both are made use of by the management in decision making and in formulating policies.
- (c) The concepts of differential costs and marginal costs mainly arise out of the difference in the behaviour of fixed and variable costs.
- (d) Differential costs compare favourably with the economist's definition of marginal cost, viz. That marginal cost is the amount which at any given volume of output is changed if output is increased or decreased by one unit.

### Difference

- (a) Differential cost analysis can be made in the case of both absorption costing as well as marginal costing.
- (b) While marginal costing excludes the entire fixed costs, some of the fixed costs may be taken into account as being relevant for the purpose of differential cost analysis.
- (c) Marginal costs may be embodied in the accounting system whereas differential costs are worked out separately as analysis statements.
- (d) In marginal costing, margin of contribution and contribution ratio are the main yardsticks for performance evaluation and for decision making. In differential cost analysis, differential costs are compared with the incremental or decremental revenues, as the case may be.

### Practical Application of Differential Costs

They are useful in managerial decisions, which are enumerated below:

- (i) Determination of most profitable levels of production and price.
- (ii) Acceptance of offer at a lower price or offering a quotation at lower selling price in order to increase capacity.
- (iii) It is used to decide whether it will be more profitable to sell a product as it is or to process it further into a different product to be sold at an increased price.
- (iv) Determining the suitable price at which raw material may be purchased.
- (v) Decision of adding a new product or business segment.
- (vi) Discontinuing a product or business segment in order to avoid or reduce the present loss or increase profit.
- (vii) Changing the product mix.
- (viii) Make or buy decisions.
- (ix) Decision regarding alternative capital investment and plant replacement.
- (x) Decision regarding change in method of production.



## 2.6 DIFFERENCES BETWEEN ABSORPTION COSTING AND MARGINAL COSTING

	Absorption Costing	Marginal Costing
1.	Both fixed and variable costs are considered for product costing and inventory valuation.	Only variable costs are considered for product costing and inventory valuation.
2.	Fixed costs are charged to the cost of production. Each product bears a reasonable share of fixed cost and thus the profitability of a product is influenced by the apportionment of fixed costs.	Fixed costs are regarded as period costs. The profitability of different products is judged by their P/V ratio.
3.	Cost data are presented in conventional pattern. Net profit of each product is determined after subtracting fixed cost along with their variable cost.	Cost data are presented to highlight the total contribution of each product.
4.	The difference in the magnitude of opening stock and closing stock affects the unit cost of production due to the impact of related fixed cost.	The difference in the magnitude of opening stock and closing stock does not affect the unit cost of production.
5.	In case of absorption costing the cost per unit reduces, as the production increases as it is fixed cost which reduces, whereas, the variable cost remains the same per unit.	In case of marginal costing the cost per unit remains the same, irrespective of the production as it is valued at variable cost.

### Difference in profit under Marginal and Absorption Costing

- **No opening and closing stock:** In this case, profit/loss under absorption and marginal costing will be equal.
- **When opening stock is equal to closing stock:** In this case, profit/loss under two approaches will be equal provided the fixed cost element in both the stocks is same amount.
- **When closing stock is more than opening stock:** In other words, when production during a period is more than sales, then profit as per absorption approach will be more than that by marginal approach. The reason behind this difference is that a part of fixed overhead included in closing stock value is carried forward to next accounting period.
- **When opening stock is more than the closing stock:** In other words when production is less than the sales, profit shown by marginal costing will be more than that shown by absorption costing. This is because a part of fixed cost from the preceding period is added to the current year's cost of goods sold in the form of opening stock.

## 2.7 APPLICATION OF MARGINAL COSTING IN DECISION MAKING

One of the basic functions of management is to make decisions. Decision making process generally involves selecting a course of action from among various alternatives. Some of the important areas where marginal costing techniques are generally applied can be giving as follows:

### 1. Selection of a Profitable Sales mix or Profitable Product mix

In case of a multi-product concern, there may arise a problem of the selection of the suitable or profitable sales mix i.e., the determination of the ratio in which various products are produced and sold. For the purpose of determining the profitable sales mix, the amount of contribution available under each alternative of sales mix is to be considered and the sales mix giving maximum total contribution



will be selected. But the various problems arising out of change in the sales mix e.g., limiting factors etc., must be properly considered.

### Illustration 2

Pankaj Ltd., engaged in the manufacture of the two products 'A' and 'B' gives you the following information:

	Product A (₹)	Product B (₹)
Selling Price per unit	60	100
Direct materials per unit	20	25
Direct wages per unit @ ₹ 0.50 per hour	10	15
Variable overhead	100% of direct wages	
Fixed overhead	₹ 10,000 per annum	
Maximum capacity	1,000 units	

Show the contribution of each of the products A and B and recommend which of the following sales mix should be adopted:

- (a) 300 units of product A and 600 units of product B;
- (b) 450 units of product A and 450 units of product B;
- (c) 600 units of product A and 300 units of product B.

### Solution:

#### Statement of Marginal Cost

	Product A (₹)	Product B (₹)
Direct Materials	20.00	25.00
Direct Wages	10.00	15.00
Variable Overhead (100% of direct wages)	10.00	15.00
Marginal Cost	40.00	55.00
Selling price	60.00	100.00
Contribution per unit	20.00	45.00

Calculation of Total Contribution:

Sales alternative (a): 300 units of 'A' and 600 units of 'B'

Contribution:

	₹
Product A : 300 units × ₹ 20	6,000
Product B : 600 units × ₹ 45	27,000
Total Contribution	33,000
Less: Fixed Overhead	10,000
Profit	23,000



Sales alternative (b): 450 units of 'A' and 450 units of 'B'

Contribution:

	₹
Product A : 450 units × ₹ 20	9,000
Product B : 450 units × ₹ 45	20,250
Total Contribution	29,250
Less: Fixed Overhead	10,000
Profit	19,250

Sales alternative (c): 600 units of 'A' and 300 units of 'B'

Contribution:

	₹
Product A : 600 units × ₹ 20	12,000
Product B : 300 units × ₹ 45	13,500
Total Contribution	25,500
Less: Fixed Overhead	10,000
Profit	15,500

Hence sales mix under alternative (a) is more profitable as it gives maximum total contribution and profit.

## 2. Problem of Limiting Factors

Limiting factor (also known as 'key factor') is a factor which limits production and/or sales and thus prevents the manufacturing concern from earning unlimited profits. The limiting factors or key factors may be shortage of raw material, shortage of skilled labour and machine capacity, market for sales etc. In case of the existence of a key factor, a problem may arise as to which product should be pushed more in order to maximise profits. Selection of the profitable product shall be made on the basis of the contribution per unit of limiting factor. The profitability of a product with reference to limiting factor can be assessed as follows:

Profitability = Contribution / Limiting Factor per unit

### Illustration 3

In a factory producing two different kinds of articles, the limiting factor is the availability of labour. From the following information, show which product is more profitable:

	Product A Cost per unit (₹)	Product B Cost per unit (₹)
Materials	5.00	5.00
Labour:		
6 Hours @ ₹ 0.50	3.00	
3 Hours @ ₹ 0.50		1.50
Overhead:		
Fixed (50% of labour)	1.50	0.75



Variable	1.50	1.50
Total Cost	11.00	8.75
Selling Price	14.00	11.00
Profit	3.00	2.25
Total Production for the month (Units)	500	600

**Maximum capacity per month is 4,800 hours.**

**Give proof in support of your answer.**

**Solution:**

**Statement of Profitability**

	Product A (₹)	Product B (₹)
Materials	5.00	5.00
Labour	3.00	1.50
Variable Overhead	1.50	1.50
Marginal Cost per unit	9.50	8.00
Selling Price per unit	14.00	11.00
Contribution per unit	4.50	3.00
No. Of Labour Hours per unit (Limiting Factor)	6	3
Contribution per Labour Hour	$\frac{₹ 4.50}{6 \text{ Hrs.}}$	$\frac{₹ 3.00}{3 \text{ Hrs.}}$
	₹ 0.75	₹ 1.00

Product B is more profitable as it gives higher contribution per labour hour (limiting factor).

Proof:

	Product A	Product B
Maximum capacity per month	4,800 Hrs.	4,800 Hrs.
Maximum capacity (in units)	4,800 Hrs.	4,800 Hrs.
	6 Hrs.	3 Hrs.
$\frac{\text{Total Hours}}{\text{Hours Per Unit}}$	800 units	1,600 units

**Statement of Cost and Profit**

	₹	₹
Materials	4,000	8,000
Labour @ ₹ 0.50 per labour hour for 4,800 hours.	2,400	2,400
Overhead:		
Fixed (50% of labour)	1,200	1,200
Variable	1,200	2,400
Total cost	8,800	14,000
Profit	2,400	3,600
Sales	11,200	17,600



### 3. Make or Buy Decisions

Sometimes a manufacturer has to decide as to whether a certain component or spare part should be manufactured in the factory (having unused installed capacity) or bought from the market. In taking such a 'make or buy' decision, the marginal cost of the component or spare part should be compared with the market price. If the marginal cost is lower than the market price, the component or spare part should be manufactured in the factory itself. However, the manufacturer must take into consideration any increase in fixed costs or any Limiting factor which may arise if the production is undertaken in the factory. If the purchase price is lower than the marginal cost and provided regular supply and proper quality of the component are guaranteed by outside supplier, it should be purchased from outside supplier.

#### Illustration 4

A mobile manufacturing company finds that while it costs ₹ 6.25 each to make a component X – 2370, the same is available in the market at ₹ 5.75 with an assurance of continued supply. The break-down of cost is:

Direct materials	₹ 2.75 each
Direct labour	₹ 1.75 each
Other variables	₹ 0.50 each
Depreciation and other fixed cost	₹ 1.25 each
Total	₹ 6.25 each

- (a) Should you make or buy?  
 (b) What would be your decision if the supplier offers the component at ₹ 4.85 each?

#### Solution:

#### Calculation of Marginal Cost of Component X – 2370

	Per unit
	₹
Direct Material	2.75
Direct Labour	1.75
Other Variables	0.50
Marginal Cost	5.00

- (a) Since the marginal cost per unit of ₹ 5 is lower than the market price of ₹ 5.75, it is recommended to manufacture the component in the factory.  
 (b) Since the purchase price of ₹ 4.85 is lower than the marginal cost, the component should be bought from outside supplier provided proper quality and regular supply are guaranteed.

### 4. Diversification of Production

Sometimes a manufacturer may intend to add a new product to the existing product or products to utilize the idle capacity, to capture a new market or for some other purpose. In such a case, the manufacturer or management is interested in knowing the profitability of the new product before its production can be undertaken. It is advisable to undertake the production of the new product if it is capable of contributing something towards fixed costs and profit after meeting out its variable Cost of sales. Fixed costs are not to be considered on the assumption that the new product can be



manufactured by existing resources without incurring any additional fixed costs. But if the introduction of a new product involves some specific or identifiable fixed costs (which arise due to the new product), these should be deducted from the contribution of the new product before making any decision.

But if the introduction of a new product involves some specific or identifiable fixed costs (which arise due to the new product), these should be deducted from the contribution of the new product before making any decision.

### Illustration 5

The following data are available in respect of product 'A' manufactured by Pankaj Ltd.:

	₹
Sales	2,50,000
Direct materials	1,00,000
Direct wages	50,000
Variable overhead	25,000
Fixed overhead	50,000

The company now proposes to introduce a new product 'B' so that sales may be increased by ₹ 50,000. There will be no increase in fixed costs and the estimated variable costs of the product 'B' are:

	₹
Direct materials	24,000
Direct wages	11,000
Overhead	7,000

Advise whether product B will be profitable or not.

### Solution:

#### Statement of Marginal Cost under proposed position

	Product A (₹)	Product B (₹)	Total (₹)
Direct materials	1,00,000	24,000	1,24,000
Direct wages	50,000	11,000	61,000
Variable overhead	25,000	7,000	32,000
Marginal Cost	1,75,000	42,000	2,17,000
Sales	2,50,000	50,000	3,00,000
Contribution	75,000	8,000	83,000
Less: Fixed Overhead	50,000	-	50,000
Profit	25,000	8000	33,000

Assuming that spare capacity cannot be used for any other purpose (except for producing product 'B'), it is advisable to undertake the production of product 'B' which shall give a contribution of ₹ 8,000 towards fixed costs and profit.

### 5. Fixation of Selling price

Marginal costing techniques assist the management in the fixation of the selling price of different products. Marginal cost of a product is the guiding factor in the fixation of selling price. Generally, the



selling price of a product is fixed at a level which not only covers the marginal cost but also contributes something towards fixed costs. Hence, under normal circumstances for a long period, the fixation of selling price is done on the basis of the total cost of sales (i.e., by adding some margin of profit to the total cost).

But in times of cut-throat competition, trade depression, in accepting additional orders for utilizing unused capacity and in exploring foreign markets, the manufacturer may be ready to sell his products at a price below total cost but not at a price below marginal cost. For fixing the price at a level below total cost of sales, the manufacturer shall take into account the overall profitability or P/V Ratio of the business concern. Thus, the fixation of selling price becomes easy where marginal cost, overall P/V Ratio and the level of profits expected, are known. In case of exports to foreign markets, the effect of various direct and indirect benefits such as cash compensatory assistance, subsidies, import entitlements and other special favours or benefits from the Government should also be taken into account.

Further, pricing at or below marginal costs may be considered desirable for a Shorter period under certain special circumstances given below:

- (i) To introduce a new product in the market or to popularize it.
- (ii) To drive out weaker competitors from the market.
- (iii) To maintain production in order to avoid retrenchment of employees.
- (iv) To keep the plant and machinery in gear.
- (v) To avoid the loss of future markets.
- (vi) To sell the goods of perishable nature.
- (vii) To push up the sales of other conjoined profitable products.

### Illustration 6

P. Co. Ltd., has an overall P/V Ratio of 60%. If the variable cost of a product is ₹ 20, what will be its selling price?

#### Solution:

Overall P/V Ratio of the company = 60%

$$\text{P/V Ratio} = \frac{\text{Contribution}}{\text{Sales}} = \frac{\text{Sales} - \text{Variable Cost}}{\text{Sales}}$$

If selling price is assumed to be 100.

Contribution = 60

Variable Cost = 100 – 60 = 40

Thus, when variable cost is 40, selling price = 100

When variable cost is 1 selling price will be =  $\frac{100}{40}$

When variable cost is 20, selling price will be =  $\frac{100}{40} \times 20 = ₹ 50$ .



### Export Market vs. Home Market

A firm engaged in supplying goods in the home market and having surplus production capacity, may think of utilising it to meet export orders at a price lower than that prevailing in the home market. Such a decision is made only when the local sale is earning a profit i.e., when its fixed costs have already been recovered by the local sales. In such cases, if the export price is more than the marginal cost, it is advisable to enter the export market. Any reduction in the selling price in the local market to utilise the surplus capacity may adversely affect the normal local sales.

However, dumping in the export market at a lower price even below marginal cost in order to capture future market, has no adverse effect on local sales.

### Illustration 7

Indo-US Company has a capacity to produce 5,000 articles but actually produced only 2,000 articles for home market at the following costs:

	₹
Materials	40,000
Wages	36,000
Factory Overheads:	
Fixed	12,000
Variable	20,000
Administration overhead (Fixed)	18,000
Selling and Distribution overhead:	
Fixed	10,000
Variable	16,000
	1,52,000

The home market can consume only 2,000 articles at a selling price of ₹ 80 per article. An additional order for the supply of 3,000 articles is received from a foreign customer at ₹ 65 per article. Should this order be accepted or not?

### Solution:

#### Calculation of Present Profitability

Particulars	₹	₹
Sales (2,000 Articles @ ₹ 80 per article)		1,60,000
Less: Marginal Cost:		
Materials	40,000	
Wages	36,000	
Variable Overheads:		
Factory	20,000	
Selling and Distribution	16,000	1,12,000
Contribution		48,000
Less: Fixed overheads:		



Factory	12,000	
Office	18,000	
Selling & Distribution	10,000	40,000
Profit		8,000

Since there is a profit of ₹ 8,000 at the existing level of 2,000 articles sold in the home market, the fixed costs are fully recovered.

#### 6. Alternative Methods of Manufacture

Sometimes a manufacturer is faced with the problem of the application of alternative methods of manufacture i.e., whether machine work or hand work, employment of hand-driven machine or power-driven machine or employment of one machine or another machine etc. For the purpose of selecting the method of production to be adopted, a comparison of the amount of contribution available under different methods of manufacture shall be made. The alternative providing the maximum contribution per unit shall be considered to be more profitable. However, the limiting factor, if any, involved in the method of production, must be given proper consideration.

#### 7. Operate or Shut down Decision

In case of a multi-product concern, it may be found that the production of some of its products is being carried on at a loss. Under such a position, the production of non-profitable products shall have to be discontinued. But if the choice is out of two or more products, the decision shall be taken with reference to the amount of contribution or P/V Ratio of these products. Production of the product giving the least amount of contribution or least PN Ratio should be discontinued on the assumption that production capacity thus freed can be used to produce other profitable products.

#### 8. Maintaining a Desired Level of Profit

Sometimes the management may be interested in maintaining a desired level of profits under the conditions of a change in the sales price. The volume of sales required to earn a desired level of profits can be ascertained by applying marginal costing techniques. For ascertaining the sales required earning a desired level of profits, the following formulae are applied:

$$(i) \text{ Number of Units to be sold to earn Desired Profits} = \frac{\text{Total Fixed Cost} + \text{Desired Profits}}{\text{Contribution Per Unit}}$$

$$(ii) \text{ Sales value required to earn Desired Profits} = \frac{\text{Total Fixed Cost} + \text{Desired Profits}}{\text{P/V Ratios}}$$

#### Illustration 8

A company produces and markets industrial containers and packing cases. Due to competition, the company proposes to reduce the selling price. If the present level of profit is to be maintained, indicate the number of units to be sold if the proposed reduction in selling price is:

- (a) 5%;            (b) 10%;            (c) 15%.

The following additional information is available:

	₹	₹
Present Sales Turnover (30,000 units)		3,00,000
Variable Cost (30,000 units)	1,80,000	
Fixed Cost	70,000	2,50,000
Net Profit		50,000

**Solution:****Calculation of Contribution**

	Present Conditions	Anticipated Conditions (Reduction in Selling Price)		
		5% Reduction	10% Reduction	15% Reduction
	₹	₹	₹	₹
Selling price per unit	10.00	9.50	9.00	8.50
Less: Variable cost per unit $\left(\frac{₹1,80,000}{30,000 \text{ units}}\right)$	6.00	6.00	6.00	6.00
Contribution per unit	4.00	3.50	3.00	2.50

Number of units to be sold to earn desired profits =  $\frac{\text{Total Fixed Cost} + \text{Desired Profits}}{\text{Contribution Per Unit}}$

(i) Under Present Conditions =  $\frac{₹70,000 + ₹50,000}{₹4} = 30,000$  units

(ii) At a Price Reduction of 5% =  $\frac{₹70,000 + ₹50,000}{₹3.50} = 34,286$  units

(iii) At a Price Reduction of 10% =  $\frac{₹70,000 + ₹50,000}{₹3} = 40,000$  units

(iv) At a Price Reduction of 15% =  $\frac{₹70,000 + ₹50,000}{₹2.50} = 48,000$  units

**9. Alternate Courses of Action**

Sometimes the management has to select a course of action from amongst various alternative courses. Each course of action has its own merits and limitations. The course of action to be selected should ensure maximum profit to the business concern. The appraisal of the various courses of action available is possible through the analysis of contribution. The course of action ensuring highest contribution is generally adopted by the management.

**Illustration 9**

Excel Ltd. manufactures and markets a single product. The following data are available:

	₹ Per unit
Materials	16
Conversion costs (variable)	12
Dealer's Margin	4
Selling Price	40
Fixed cost : ₹ 5 lakhs	
Present Sales: 90,000 units	
Capacity utilisation: 60 per cent	





There is acute competition. Extra efforts are necessary to sell. Suggestions have been made for increasing sales:

- (a) By reducing the sales price by 5 per cent.  
 (b) By increasing dealer's margin by 25 per cent on the existing rate.

Which of these two suggestions you would recommend if the company desires to maintain the present profit. Give reasons.

**Solution:**

**Statement of Profitability (90,000 units)**

	Per unit	Total
	₹	₹
Marginal Cost:		
Materials	16	14,40,000
Conversion Cost	12	10,80,000
Dealer's Margin	4	3,60,000
Total Marginal Cost	32	28,80,000
Sales	40	36,00,000
Contribution	8	7,20,000
Less: Total Fixed Cost		5,00,000
Total Profit		2,20,000

Ascertainment of the effect of various suggestions:

Suggestion (a)

	₹
Revised Selling Price (₹ 40 – 5% of ₹ 40)	38
Dealer's Margin at existing rate of 10% on sales (since it is variable)	3.80

Suggestion (b)

	₹
Selling Price (no change)	40
Dealer's Margin (Existing rate ₹ 4 + 25% of ₹ 4)	5

**Statement of Revised Profitability**

	Suggestion (a)	Suggestion (b)
	₹	₹
Materials	16.00	16.00
Conversion Cost	12.00	12.00
Dealer's Margin	3.80	5.00
Variable Cost per unit	31.80	33.00
Selling price per unit	38.00	40.00
Contribution per unit	6.20	7.00



Sales (in units) to maintain the existing profitability of ₹ 2,20,000:

$$\text{Required Sales (in units)} = \frac{\text{Total Fixed Cost} + \text{Desired Profits}}{\text{Contribution Per Unit}}$$

$$\text{As per suggestion (a)} = \frac{₹5,00,000 + ₹2,20,000}{₹6.20} = 1,16,129 \text{ units}$$

$$\text{As per suggestion (b)} = \frac{₹5,00,000 + ₹2,20,000}{₹7} = 1,02,857 \text{ units}$$

The company should adopt suggestion (b) since it ensures the present profitability of ₹ 2,20,000 at a lower level of production activity of 1,02,857 units as compared to 1,16,129 units under suggestion (a). It is given that competition is acute.

### 10. Profit Planning

Profit planning is one of the important functions of management. It relates to the attainment of maximum profit. Profit planning requires the management to have the proper knowledge of the inter relationship of selling prices, sales volume, variable cost, and fixed costs. Marginal costing helps the management in ascertaining the profit position at the various levels of operation through the technique of cost volume profit analysis. Thus, the management can plan its operations at the optimum level where profits are maximum.

#### Illustration 10

Ambitious Enterprises is currently working at 50% capacity and produces 10,000 units.

At 60% working, raw material cost increases by 2% and selling price fall by 2%. At 80% working, raw material cost increases by 5% and selling price fall by 5%.

At 50% capacity working, the product costs ₹ 180 per unit and is sold at ₹ 200 per unit.

The cost of ₹ 180 is made up as follows:

	₹
Material	100
Wages	30
Factory overheads	30 (40% Fixed)
Administration overheads	20 (50% Fixed)

Prepare a Marginal cost Statement showing the estimated profit of the business when it is operated at 60 per cent and 80 per cent capacity.

**Solution:****Statement of Marginal Cost**

	50% Capacity	60% Capacity	80% Capacity
	10,000 units (₹)	12,000 units (₹)	16,000 units (₹)
Materials	10,00,000	12,24,000	16,80,000
Wages	3,00,000	3,60,000	4,80,000
Variable Overheads			
Factory	1,80,000	2,16,000	2,88,000
Administration	1,00,000	1,20,000	1,60,000
Total Marginal cost	15,80,000	19,20,000	26,08,000
Sales	(10,000 × ₹ 200) 20,00,000	(12,000 × ₹ 196) 23,52,000	(16,000 × ₹ 190) 30,40,000
Total contribution	4,20,000	4,32,000	4,32,000
Less: Fixed Cost	2,20,000	2,20,000	2,20,000
Profit	2,00,000	2,12,000	2,12,000

**Calculation of Variable and Fixed Overhead at 50 per cent capacity**

	Factory Overhead (₹)	Administration Overhead (₹)
Total Overhead (10,000 units)	3,00,000	2,00,000
Less: Fixed Overhead	1,20,000	1,00,000
	(40%)	(50%)
Variable Overhead	1,80,000	1,00,000
Variable Overhead per unit	$\frac{₹1,80,000}{10,000 \text{ units}}$	$\frac{₹1,00,000}{10,000 \text{ units}}$
	₹ 18	₹ 10

**2.8 TRANSFER PRICING****Introduction and Meaning**

A Transfer Price is that notional value at which goods and services are transferred between divisions in a decentralised organisation.

In the modern days, production is on the mass scale due to technological advancement and upgradation. Organisations grow in course of time and for such growing organisations, decentralization becomes absolutely necessary. It becomes inevitable for such organisations to establish separate divisions and departments to ensure smooth working. Transfer pricing has become necessary in highly decentralized companies where number of divisions/ departments are created as a part and parcel of the decentralized organisation. Transfer pricing is one of the tools in the hands of management for measuring the performance of divisions or departments.



Transfer prices are normally set for intermediate products, which are goods, and services that are supplied by the selling division to the buying division. In large organisations, each division is treated as a 'profit center' as a part and parcel of decentralization. Their profitability is measured by fixation of 'transfer price' for inter divisional transfers.

The transfer price can have impact on the division's performance and hence lot of care is to be taken in fixation of the same. The following factors should be taken into consideration before fixing the transfer prices.

- (1) Transfer price should help in the accurate measurement of divisional performance.
- (2) It should motivate the divisional managers to maximize the profitability of their divisions.
- (3) Autonomy and authority of a division should be ensured.
- (4) Transfer Price should allow 'Goal Congruence' which means that the objectives of divisional managers match with those of the organisation.

## 2.9 OBJECTIVES OF INTER COMPANY TRANSFER PRICING

The following are the main objectives of intercompany transfer pricing scheme:

1. **To evaluate the current performance and profitability of each individual unit:** This is necessary in order to determine whether a particular unit is competitive and can stand on its working. When the goods are transferred from one department to another, the revenue of one department becomes the cost of another and such inter transfer price affects the reported profits.
2. **To improve the profit position:** Intercompany transfer price will make the unit competitive so that it may maximize its profits and contribute to the overall profits of the organisation.
3. **To assist in decision making:** Correct intercompany transfer price will make the costs of both the units realistic in order to take decisions relating to such problems as make or buy, sell or process further, choice between alternative methods of production.
4. **For accurate estimation of earnings on proposed investment decisions:** When finance is scarce and it is required to determine the allocation of scarce resources between various divisions of the concern taking into consideration their competing claims, then this technique is useful.

## 2.10 METHODS OF TRANSFER PRICING

It is the notional value of goods and services transferred from one division to other division. In other words, when internal exchange of goods and services take place between the different divisions of a firm, they have to be expressed in monetary terms. The monetary amount for those inter divisional exchanges is called as 'transfer price'. The determination of transfer prices is an extremely difficult and delicate task as lot of complicated issues are involved in the same. Inter division conflicts are also possible. There are several methods of fixation of 'Transfer Price'. They are discussed below.

1. Pricing based on cost.
  - (a) Actual cost
  - (b) Cost plus
  - (c) Standard cost
  - (d) Marginal cost



2. Market price as transfer price.
3. Negotiated pricing.
4. Pricing based on Opportunity cost.
1. **Pricing based on cost:** - In these methods, 'cost' is the base and the following methods fall under this category.
  - (a) **Actual Cost:** - Under this method the actual cost of production is taken as transfer price for inter divisional transfers. Such actual cost may consist of variable cost or sometimes total costs including fixed costs.
  - (b) **Cost Plus:** - Under this method, transfer price is fixed by adding a reasonable return on capital employed to the total cost. Thereby the measurement of profit becomes easy.
  - (c) **Standard Cost:** - Under this method, transfer price is fixed on the basis of standard cost. The difference between the standard cost and the actual cost being variance is absorbed by transferring division. This method is simple and easy to follow, but the constant revision of standards is necessary at regular intervals.
  - (d) **Marginal Cost:** - Under this method, the transfer price is determined on the basis of marginal cost. The reason being fixed cost is in any case unavoidable and hence should not be charged to the buying division. That is why only marginal cost will be taken as transfer price
2. **Market price as transfer price:** - Under this method, the transfer price will be determined according to the market price prevailing in the market. It acts as a good incentive for efficient production to the selling division and any inefficiency in production and abnormal costs will not be borne by the buying division. The logic used in this method is that if the buying division would have purchased the goods/services from the open market, they would have paid the market price and hence the same price should be paid to the selling division. One of the variation of this method is that from the market price, selling and distribution overheads should be deducted and price thus arrived should be charged as transfer price. The reason behind this is that no selling efforts are required to sale the goods/services to the buying division and therefore these costs should not be charged to the buying division. Market price based transfer price has the following advantages:
  1. Actual costs are fluctuating and hence difficult to ascertain. On the other hand market prices can be easily ascertained.
  2. Profits resulting from market price based transfer prices are good parameters for performance evaluation of selling and buying divisions.
  3. It avoids extensive arbitration system in fixing the transfer prices between the divisions.

However, the market price based transfer pricing has the following limitations:

1. There may be resistance from the buying division. They may question buying from the selling division if in any way they have to pay the market prices.
2. Like cost based prices, market prices may also be fluctuating and hence there may be difficulties in fixation of these prices.
3. Market price is a rather vague term as such prices may be ex-factory price, wholesale price, retail price etc.
4. Market prices may not be available for intermediate products, as these products may not have any market.
5. This method may be difficult to operate if the intermediate product is for captive consumption.
6. Market price may change frequently.
7. Market prices may not be ascertained easily.



3. **Negotiated Pricing:** - Under this method, the transfer prices may be fixed through negotiations between the selling and the buying division. Sometimes it may happen that the concerned product may be available in the market at a cheaper price than charged by the selling division. In this situation the buying division may be tempted to purchase the product from outside sellers rather than the selling division. Alternatively the selling division may notice that in the outside market, the product is sold at a higher price but the buying division is not ready to pay the market price. Here, the selling division may be reluctant to sell the product to the buying division at a price, which is less than the market price. In all these conflicts, the overall profitability of the firm may be affected adversely. Therefore it becomes beneficial for both the divisions to negotiate the prices and arrive at a price, which is mutually beneficial to both the divisions. Such prices are called as 'Negotiated Prices'. In order to make these prices effective care should be taken that both, the buyers and sellers should have access to the available data including about the alternatives available if any. Similarly buyers and sellers should be free to deal outside the company, but care should be taken that the overall interest of the organisation is not affected.
- The main limitation of this method is that lot of time is spent by both the negotiating parties in fixation of the negotiated prices.
  - Negotiating skills are required for the managers for arriving at a mutually acceptable price, otherwise there is a possibility of conflicts between the divisions.
4. **Pricing based on opportunity cost:** - This pricing recognizes the minimum price that the selling division is ready to accept and the maximum price that the buying division is ready to pay. The final transfer price may be based on these minimum expectations of both the divisions. The most ideal situation will be when the minimum price expected by the selling division is less than the maximum price accepted by the buying division. However in practice, it may happen very rarely and there is possibility of conflicts over the opportunity cost.

It is very clear that fixation of transfer prices is a very delicate decision. There might be clash of interests between the selling and buying division and hence while fixing the transfer price, overall interests of the organisation should be taken into consideration and overall 'Goal Congruence' should be given utmost importance rather than interests of the selling or buying division.

### Illustration 11

The following information relates to budgeted operations of Division P of a manufacturing company.

Particulars	Amount (₹)
Sales – 50,000 units @ ₹ 8	4,00,000
Less: Variable Costs @ ₹ 6 per unit	3,00,000
Contribution margin	1,00,000
Less: Fixed Costs	75,000
Divisional Profits	25,000

The amount of divisional investment is ₹1,50,000 and the minimum desired rate of return on the investment is the cost of capital of 20%.

Calculate

- Divisional expected ROI and
- Divisional expected RI

**Solution:**

$$(i) \text{ ROI} = ₹ 25,000 / 1,50,000 \times 100 = 16.7\%$$

$$(ii) \text{ RI} = \text{Divisional Profits} - \text{Minimum desired rate of return} = 25,000 - 20\% \text{ of } 1,50,000 = (₹ 5,000)$$

**Illustration 12**

A company has two divisions, X and Y. Division X manufactures a component which is used by Division Y to produce a finished product. For the next period, output and costs have been budgeted as follows.

Particulars	Division X	Division Y
Component units	50,000	---
Finished units	---	50,000
Total variable costs – Rupees	2,50,000	6,00,000
Fixed Costs Rupees	1,50,000	2,00,000

The fixed costs are separable for each division. You are required to advise on the transfer price to be fixed for Division X's component under the following circumstances.

- Division A can sell the component in a competitive market for ₹10 per unit. Division Y can also purchase the component from the open market at that price.
- As per the situation mentioned in (A) above, and further assume that Division Y currently buys the component from an external supplier at the market price of ₹10 and there is reciprocal agreement between the external supplier and another Division Z, within the same group. Under this agreement, the external supplier agrees to buy one product unit from Division Z at a profit of ₹4 per unit to that division, for every component which Division B buys from the sup.

**Solution:**

Transfer price decisions can be taken on the following basis.

- Transfer Price: - Marginal Cost + Opportunity Cost i.e. ₹ (5 + 5) = ₹ 10

Note: Marginal Cost = ₹ 2, 50,000 / 50,000 units = ₹ 5

Opportunity cost ₹ 5 are computed on the basis that the Division X will sacrifice ₹ 5 if they sell the product to Division Y.

- In this situation, the transfer price will be worked out as under:

Transfer price = Marginal Cost + Contribution + Profit foregone by Division Z

$$= ₹ (5 + 5 + 4) = ₹ 14$$

In situation (B), if Division Y purchases from Division X, it will not purchase from external supplier. Hence, the supplier will stop purchasing from Division Z, which will result in a loss of profit to Division Z @ ₹ 4 per unit, and therefore this amount will be recovered from the transfer price.

**Illustration 13**

A company fixes the inter-divisional transfer prices for its products on the basis of cost plus an estimated return on investment in its divisions. The relevant portion of the budget for the Division X for the year 2015-16 is given below:



Particulars	Amount in (₹)
Fixed Assets	5,00,000
Current Assets (other than debtors)	3,00,000
Debtors	2,00,000
Annual fixed cost for the division	8,00,000
Variable cost per unit of product	10
Budgeted volume of production per year (units)	4,00,000
Desired Return on Investment	28%

You are required to determine the transfer price for Division X.

**Solution:**

**Computation of Transfer Price per unit for division X**

Particulars	Amount in (₹)
Variable cost	10.00
Fixed cost (8,00,000 / 4,00,000)	2.00
Total Cost	12.00
Add: Desired return (10,00,000 × 28%) ÷ 4,00,000	0.70
Transfer Price	12.70

**Illustration 14**

XYZ Ltd which has a system of assessment of Divisional Performance on the basis of residual income has two Divisions, Alfa and Beta. Alfa has annual capacity to manufacture 15,00,000 numbers of a special component that it sells to outside customers, but has idle capacity. The budgeted residual income of Beta is ₹ 1,20,00,000 while that of Alfa is ₹ 1,00,00,000. Other relevant details extracted from the budget of Alfa for the current years were as follows:

Particulars	
Sale (outside customers)	12,00,000 units @ ₹ 180 per unit
Variable cost per unit	₹ 160
Divisional fixed cost	₹ 80,00,000
Capital employed	₹ 7,50,00,000
Cost of Capital	12%

Beta has just received a special order for which it requires components similar to the ones made by Alfa. Fully aware of the idle capacity of Alfa, beta has asked Alfa to quote for manufacture and supply of 3,00,000 numbers of the components with a slight modification during final processing. Alfa and Beta agree that this will involve an extra variable cost of ₹ 5 per unit.

You are required to calculate,

The transfer price which Alfa should quote to Beta to achieve its budgeted residual income.



**Solution:****(i) Contribution required at Budgeted Residual Income**

	₹
Fixed cost	80,00,000
Profit on 7,50,00,000 × 12%	90,00,000
Residual Income	1,00,00,000
Total Contribution required	2,70,00,000

Contribution derived from existing units =  $12,00,000 \times 20 = ₹ 2,40,00,000$

Contribution required on 3,00,000 units =  $2,70,00,000 - 2,40,00,000 = ₹ 30,00,000$

Contribution per unit =  $30,00,000 / 3,00,000 = ₹ 10$

Increase in Variable cost = ₹ 5

$$\begin{aligned} \therefore \text{Transfer price} &= \text{V.C} + \text{Desired Residual Income} + \text{Increase in VC} \\ &= 160 + 10 + 5 \\ &= ₹ 175 \end{aligned}$$

(ii) If Beta can buy from outside at less than the Variable cost of manufacture, i.e. ₹ 165, then only the decision to transfer price of ₹ 175, will be sub-optimal for the group as whole.

**Illustration 15**

Transferor Ltd. has two processes – Preparing and Finishing. The normal output per week is 7,500 units (completed) at a capacity of 75%.

Transferee Ltd. had production problems in preparing and require 2,000 units per week of prepared material for their finishing process.

The existing cost structure of one prepared unit of Transferor Ltd. at the existing capacity is as follows.

Material: ₹ 2.00 (variable 100%)

Labour: ₹ 2.00 (variable 50%)

Overheads: ₹ 4.00 (variable 25%)

The sale price of a completed unit of Transferor Ltd. is ₹ 16 with a profit of ₹ 4 per unit.

Contrast the effect on the profits of Transferor Ltd. for 6 months (25 weeks) of supplying units to Transferor Ltd. with the following alternative transfer prices per unit.

- (i) Marginal Cost
- (ii) Marginal Cost + 25%
- (iii) Marginal cost + 15% return on capital employed. (Assume capital employed ₹ 20 lakhs)
- (iv) Existing Cost
- (v) Existing Cost + a portion of profit on the basis of preparing cost / total cost × unit profit
- (vi) At an agreed market price of ₹ 8.50.

Assume no increase in the fixed costs.

**Solution:**

Transferred units  $(25 \times 2,000) = 50,000$

Existing profit  $(7500 \times 25 \times 4) = ₹ 7,50,000$

Effect on profit if transfer price is:

(i) Marginal cost

	₹
Material	2.00
Labour	1.00
Overheads	1.00
	4.00

At this transfer price there is no effect on profit of transferor Ltd.

(ii) Increase of Profit ₹ 50,000

(iii) Profit per unit  $= 4 + \{(2000000 \times 15\% \times 0.5)/50000\} = ₹ 7$

Under this price profit of transferor Ltd is increases by ₹ 1,50,000 i.e.,  $50,000 \times (7-4)$

(iv) Profit increases by  $50,000 \times (8-4) = ₹ 2,00,000$

(v) Transfer price:

	₹
$\{8 + (8/12)4\}$	10.67
(-) profit	4.00
	6.67

Profit increases by  $50000 \times 6.67 = ₹ 3,33,500/-$

(vi) Transfer price = 8.50

Profit increase by  $4.5 \times 50000 = ₹ 2,25,000$

**Illustration 16**

Division A is a profit centre that produces three products X, Y and Z and each product has an external market.

The relevant data is as:

	X	Y	Z
External market price per unit (₹)	48	46	40
Variable cost of production (division A) (₹)	33	24	28
Labour hours per unit (division A)	3	4	2
Maximum external sales units	800	500	300

Up to 300 units of Y can be transferred to an internal division B.

Division B has also the option of purchasing externally at a price of ₹ 45 per unit.

Determine the transfer price for Y the total labour hours available in division A is:

(a) 3800 hours

(b) 5600 hours

**Solution:****Computation of contribution per labour hour from external sales**

	X	Y	Z
Market price (₹)	48	46	40
Variable cost (₹)	33	24	28
Contribution (₹)	15	22	12
Labour hours required	3	4	2
Contribution per labour hour (₹)	5	5.50	6
Priority	III	II	I

Computation of transfer price when

(a) The capacity is 3800 hours:

Hours required for	Z = 300 x 2	= 600
	Y = 500 x 4	= 2000
	X = 800 x 3	= 2400
		5000

The existing capacity is not sufficient to produce the units to meet the external sales. In order to transfer 300 units of Y, 1200 hours are required in which division A will give up the production of X to this extent.

	₹
Variable cost of Y	24
(+) contribution lost by giving up production of X to the extent of 1200 hours = 1200 x 5 = ₹ 6,000	
∴ Opportunity cost per unit = (6000/300)	20
Required transfer price	44

(b) If the capacity is 5600 hours:

	₹
Variable cost	24
Contribution lost by giving up X to the extent of 600 hours (being opportunity cost) = 600 x 5 = 3000	
Opportunity cost per unit = (6000/300)	10
Required transfer price	34

**Illustration 17**

Rana manufactures a product by a series of mixing of ingredients. The product is packed in company's made bottles and put into an attractive carton. One division of company manufactures the bottles while another division prepares the mix that does the packing.

The user division obtained the bottle from the bottle manufacturing division. The bottle manufacturing division has obtained the following quotations from an external source for supply of empty bottles.



Volume no of bottles	For 8,00,000 bottles	For 12,00,000 bottles
Total price offer (₹)	14,00,000	20,00,000

The estimated cost is:

Volume no of bottles	For 8,00,000 bottles	For 12,00,000 bottles
Total Cost (₹)	10,40,000	14,40,000

The sales value and the end cost in the mixing/packing division are:

Volume no of bottles	For 8,00,000 bottles	For 12,00,000 bottles
Total sales value (₹)	91,20,000	1,27,80,000
Total Cost ** (₹)	10,40,000	96,80,000

\*\* Excluding cost of bottles

There is a considerable discussion as to the proper transfer price from the bottle division to the marketing division.

The divisional managers salary is an incentive bonus based on profits of the centres.

You are required to show for the given two levels of activity the profitability of the two divisions and the total organisation based on appropriate transfer price determined on the basis of:

- (i) Shared profit related to the cost
- (ii) Market price

**Solution:**

**Statement showing Computation of transfer price on the basis of profit shared on cost basis**

Particulars	Output (8,00,000)	Output (12,00,000)
	(₹)	(₹)
Sales	91,20,000	1,27,80,000
Costs:		
Product manufacturing division	64,80,000	96,80,000
Bottle manufacturing division	10,40,000	14,40,000
	75,20,000	1,11,20,000
Profit	16,00,000	16,60,000
Share of bottle manufacturing division	2,21,276	2,14,964
Product manufacturing division	13,78,724	14,45,036
Transfer price	12,61,276	16,54,964
Transfer price per bottle	1.5777	1.379



Profitability on the basis of market price:

Particulars	Output (8,00,000)		Output (12,00,000)	
	(₹)	(₹)	(₹)	(₹)
Bottle manufacturing division				
Sale value		14,00,000		20,00,000
(-)cost		10,40,000		14,40,000
Profit		3,60,000		5,60,000
Product manufacturing division				
Sale value		91,20,000		1,27,80,000
(-)cost of product	64,80,000		96,80,000	
Cost of bottle	14,00,000	78,80,000	20,00,000	1,16,80,000
Profit		12,40,000		11,00,000
Total profit		16,00,000		16,60,000
Transfer price		1.75		1.67

### Illustration 18

PH Ltd. manufactures and sells two products, namely BXE and DXE. The company's investment in fixed assets is ₹ 2 lakh. The working capital investment is equivalent to three months' cost of sales of both the products. The fixed capital has been financed by term loan lending institutions at an interest of 11% p.a. Half of the working capital is financed through bank borrowing carrying interest at the rate of 19.4%, the other half of the working capital being generated through internal resources.

The operating data anticipated for 2015-16 is as under:

	Product BXE	Product DXE
Production per annum (in units)	5,000	10,000
Direct Material/unit:		
Material A (Price ₹ 4 per kg)	1 Kg	0.75 Kg
Material B (Price ₹ 2 per kg)	1 Kg	1 Kg
Direct labour hours	5	3

Direct wage rate ₹ 2 per hour. Factory overheads are recovered at 50% of direct wages. Administrative overheads are recovered at 40% of factory cost. Selling and distribution expenses are ₹ 2 and ₹ 3 per unit respectively of BXE and DXE. The company expects to earn an after tax profit of 12% on capital employed. The income tax rate is 50%.

Required:

- Prepare a cost sheet showing the element wise cost, total cost profit and selling price per unit of both the products.
- Prepare a statement showing the net profit of the company after taxes for the 2015-16.

**Solution:****(a) Cost sheet**

	BXE		DXE		Total
	Units	Total	Units	Total	
	₹	₹	₹	₹	₹
Direct material	6	30,000	5	50,000	80,000
Direct wages	10	50,000	6	60,000	1,10,000
Prime Cost	16	80,000	11	1,10,000	1,90,000
Factory Overheads	5	25,000	3	30,000	55,000
Factory cost	21	1,05,000	14	1,40,000	2,45,000
Office Overheads	8.40	42,000	5.60	56,000	98,000
Cost of production	29.40	1,47,000	19.60	1,96,000	3,43,000
Selling & Distribution overheads	2.00	10,000	3.00	30,000	40,000
Cost of sales	31.40	1,57,000	22.60	2,26,000	3,83,000
Profit as % on					
Fixed capital		21,818		26,182	48,000
Working capital		9,420		13,560	22,980
Sales/S.P.	37.6476	1,88,238	26.5742	2,65,742	4,53,980

**Working notes:**

		₹
Return after tax	$\{383000 \times 0.25\} + 2,00,000$ 12%	35,490
∴ Sales	$3,83,000 + 35,490 \times (1/50\%)$	4,53,980

**(b) Statement showing net profit**

		₹
Sales		4,53,980
(-) Cost of Sales		(3,83,000)
Gross Profit		70,980
(-) Interest	$\{22000 + (95750/2) 19.4\}$	(31,288)
Profit Before Tax		39,692
(-) Tax @ 50%		(19,846)
Profit After Tax		19,846



## Some more Problems on Application of Marginal Costing in Decision Making

### Problem 1

The sports material manufacturing company budgeted the following data for the coming year.

	₹
Sales (1,00,000 units)	1,00,000
Variable cost	40,000
Fixed cost	50,000

Find out

(a) P/V Ratio, B.E.P and Margin of Safety

(b) Evaluate the effect of

- (i) 20% increase in physical sales volume
- (ii) 20% decrease in physical sales volume
- (iii) 5% increase in variable costs
- (iv) 5% decrease in variable costs
- (v) 10% increase in fixed costs
- (vi) 10% decrease in fixed costs
- (vii) 10% decreases in selling price and 10% increase in sales volume
- (viii) 10% increase in selling price and 10% decrease in sales volume
- (ix) ₹ 5,000 variable cost decrease accompanied by ₹ 15,000 increase in fixed costs.

### Answer:

(a) P/V ratio, B.E.P and Margin of Safety

$$\begin{aligned} \text{Contribution} &= \text{Sales} - \text{Variable cost} \\ &= 1,00,000 - 40,000 \\ &= ₹ 60,000 \end{aligned}$$

$$\begin{aligned} \text{P/V Ratio} &= (\text{Contribution} / \text{Sales}) \times 100 \\ &= (60,000 / 1,00,000) \times 100 \\ &= 60\% \end{aligned}$$

$$\begin{aligned} \text{B.E.P sales} &= \text{Fixed cost} / \text{PV ratio} \\ &= 50,000 / 60\% \\ &= ₹ 83,333 \end{aligned}$$

$$\begin{aligned} \text{Margin of Safety} &= \text{Total sales} - \text{B.E.P sales} \\ &= 1,00,000 - 83,333 \\ &= ₹ 16,667 \end{aligned}$$



(b)

		<b>Contribution (₹)</b>	<b>P/V ratio</b>	<b>BE Sales (₹)</b>	<b>Margin of safety (₹)</b>
(i)	Increase in volume by 20%	1,20,000 – 48,000 = 72,000	(72,000 / 1,20,000) x 100 = 60%	(50,000 / 60%) = 83,333	1,20,000 – 83,333 = 36,667
(ii)	Decrease in volume by 20%	80,000 – 32,000 = 48,000	(48,000 / 80,000) x 100 = 60%	(50,000 / 60%) = 83,333	80,000 – 83,333 = (3,333)
(iii)	5% increase in variable cost	1,00,000 – 42,000 = 58,000	(58,000 / 1,00,000) x 100 = 58%	(50,000 / 58%) = 86,207	1,00,000 – 86,207 = 13,793
(iv)	5% decrease in variable cost	1,00,000 – 38,000 = 62,000	(62,000 / 1,00,000) x 100 = 62%	(50,000 / 62%) = 80,645	1,00,000 – 80,645 = 19,355
(v)	10% increase in fixed cost	1,00,000 – 40,000 = 60,000	(60,000 / 1,00,000) x 100 = 60%	(55,000 / 60%) = 91,667	1,00,000 – 91,667 = 8,333
(vi)	10% decrease in fixed costs	1,00,000 – 40,000 = 60,000	(60,000 / 1,00,000) x 100 = 60%	(45,000 / 60%) = 75,000	1,00,000 – 75,000 = 25,000
(vii)	10% decreases in selling price and 10% increase in sales volume	99,000 – 44,000 = 55,000	(55,000 / 99,000) x 100 = 55.55%	(50,000 / 55.55%) = 90,009	99,000 – 90,009 = 8,991
(viii)	10% increase in selling price and 10% decrease in sales volume	99,000 – 36,000 = 63,000	(63,000 / 99,000) x 100 = 63.63%	(50,000 / 63.63%) = 78,579	99,000 – 78,579 = 20,421
(ix)	₹5,000 variable cost decrease accompanied by ₹15,000 increase in fixed costs.	1,00,000 – 35,000 = 65,000	(65,000/1,00,000) x 100 = 65%	(65,000 / 65%) = 1,00,000	1,00,000 – 1,00,000 = 0

### Problem 2

Two businesses AB Ltd and CD Ltd sell the same type of product in the same market. Their budgeted profits and loss accounts for the year ending 30th June, 2016 are as follows:

	AB Ltd (₹)		CD Ltd (₹)	
Sales		1,50,000		1,50,000
Less: Variable costs	1,20,000		1,00,000	
Fixed Cost	15,000	1,35,000	35,000	1,35,000
Profit		15,000		15,000

You are required to calculate the B.E.P of each business and state which business is likely to earn greater profits in conditions.





- (a) Heavy demand for the product  
 (b) Low demand for the product.

**Answer:****Statement Showing Computation of P/V ratio, BEP and Determination of Profitability in Different conditions**

	Particulars	AB Ltd	CD Ltd
(i)	Sales	1,50,000	1,50,000
(ii)	Variable cost	1,20,000	1,00,000
(iii)	Contribution	30,000	50,000
(iv)	P/V ratio $[(30,000/1,50,000) \times 100]$ $[(50,000/1,50,000) \times 100]$	20%	33 1/3%
(v)	Fixed cost	15,000	35,000
(vi)	Profit	15,000	15,000
(vii)	Breakeven sales (V/IV)	75,000	1,05,000

From the above computation, it was found that the product produced by CD Ltd is more profitable in conditions of heavy demand because its P/V ratio is higher. On the other hand, in the condition of low demand, the product produced by AB Ltd is more profitable because its BEP is low.

**Problem 3**

A factory is currently working to 40% capacity and produces 10,000 units. At 50% the selling price falls by 3%. At 90% capacity the selling price falls by 5% accompanied by similar fall in prices of raw material. Estimate the profit of the company at 50% and 90% capacity production.

The cost at present per unit is:

	₹
Material	10
Labour	3
Overheads	5 (60% fixed)

The selling price per unit is ₹ 20/- per unit.

**Answer:****Statement Showing Computation of Profit at 50% and 90% Capacity as well as at Current Capacity**

	Particulars	40%		50%		90%	
		₹		₹		₹	
		Unit	Total	Unit	Total	Unit	Total
(i)	Selling Price	20.00	2,00,000	19.40	2,42,500	19.00	4,27,500
(ii)	Variable Cost						
	Material	10.00	1,00,000	10.00	1,25,000	9.50	2,13,750
	Labour	3.00	30,000	3.00	37,500	3.00	67,500



	Variable OH	2.00	20,000	2.00	25,000	2.00	45,000
		15.00	1,50,000	15.00	1,87,500	14.50	3,26,250
(iii)	Contribution	5.00	50,000	4.40	55,000	4.50	1,01,250
(iv)	Fixed Cost	3.00	30,000		30,000		30,000
(v)	Profit		20,000		25,000		71,250
(vi)	B.E. Sales $\left(\frac{F \times S}{C}\right)$		1,20,000		1,32,273		1,26,667

**Problem 4**

The sales turnover and profit during two periods were as follows:

Period	Sales (₹)	Profit (₹)
1	2,00,000	20,000
2	3,00,000	40,000

What would be probable trading results with sales of ₹1,80,000? What amount of sales will yield a profit of ₹ 50,000?

**Answer:**

$$\begin{aligned} \text{P/V ratio} &= (\text{Change in profit} / \text{Change in sales}) \times 100 \\ &= (20,000 / 1,00,000) \times 100 = 20\% \end{aligned}$$

$$\begin{aligned} \text{Fixed cost} &= (\text{Sales} \times \text{P/V ratio}) - \text{Profit} \\ &= (2,00,000 \times 0.2) - 20,000 = ₹ 20,000 \end{aligned}$$

$$\text{Sales required to earn desired profit} = \frac{\text{Fixed Cost} + \text{Desired Profit}}{\text{P/V Ratio}} = (20,000 + 50,000) / 20\% = ₹ 3,50,000$$

**Problem 5**

The following figures for profit and sales obtained from the accounts of X Co. Ltd.

Period	Sales (₹)	Profit (₹)
2014	20,000	2,000
2015	30,000	4,000

Calculate:

- P/V Ratio
- Fixed cost
- B.E. Sales
- Profit at sales ₹ 40,000 and
- Sales to earn a profit of ₹ 5,000.

**Answer:**

- (a) P/V ratio = (Change in profit / Change in sales) × 100  
= (2,000 / 10,000) × 100 = 20%
- (b) Fixed cost = (Sales × P/V ratio) – Profit  
= (20,000 × 0.2) – 2,000 = ₹ 2,000
- (c) Break even sales = Fixed cost / PV ratio  
= 2,000 / 20% = ₹ 10,000
- (d) Profit at sales ₹ 40,000 = (Sales × P/V ratio) – Fixed cost  
= (40,000 × 20%) – 2,000 = ₹ 6,000
- (e) Sales required to earn desired profit of ₹ 5,000 =  $\frac{\text{Fixed Cost} + \text{Desired Profit}}{\text{P/V Ratio}} = (2,000 + 5,000) / 20\%$   
= ₹ 35,000

**Problem 6**

The following results of a company for the last two years are as follows:

Period	Sales (₹)	Profit (₹)
2014	1,50,000	20,000
2015	1,70,000	25,000

You are required to calculate:

- (i) P/V Ratio
- (ii) B.E.P
- (iii) The sales required to earn a profit of ₹ 40,000
- (iv) Profit when sales are ₹ 2,50,000
- (v) Margin of safety at a profit of ₹ 50,000 and
- (vi) Variable costs of the two periods.

**Answer:**

- (i) P/V ratio = (Change in profit / Change in sales) × 100  
= (5,000 / 20,000) × 100 = 25%
- Fixed cost = (Sales × P/V ratio) – Profit  
= (1,50,000 × 25%) – 20,000 = ₹ 17,500
- (ii) Break even sales = Fixed cost / PV ratio  
= 17,500 / 25% = ₹ 70,000
- (iii) Sales required to earn a profit of ₹ 40,000 =  $\frac{\text{Fixed Cost} + \text{Desired Profit}}{\text{P/V Ratio}} = (17,500 + 40,000) / 25\%$   
= ₹ 2,30,000
- (iv) Profit at sales ₹ 2,50,000 = (Sales × P/V ratio) – Fixed cost  
= (2,50,000 × 25%) – 17,500 = ₹ 45,000



- (v) Margin of safety at profit of ₹ 50,000 = Profit / PV ratio  
= 50,000 / 25% = ₹ 2,00,000
- (vi) Variable cost for 2011 = 1,50,000 x 75% = ₹ 1,12,500  
Variable cost for 2012 = 1,70,000 x 75% = ₹ 1,27,500

**Problem 7**

The Reliable Battery Co. furnishes you the following income information:

	Year 2015	
	First Half (₹)	Second Half (₹)
Sales	8,10,000	10,26,000
Profit earned	21,600	64,800

From the above you are required to compute the following assuming that the fixed cost remains the same in both periods.

1. P/V Ratio
2. Fixed cost
3. The amount of profit or loss where sales are ₹ 6,48,000
4. The amount of sales required to earn a profit of ₹ 1,08,000

**Answer:**

1. P/V ratio =  $[(64,800 - 21,600) / (10,26,000 - 8,10,000)] \times 100 = 20\%$
2. Fixed cost = (Sales x P/V ratio) – Profit =  $(8,10,000 \times 20\%) - 21,600 = ₹ 1,40,400$
3. Profit/Loss when sales are ₹ 6,48,000 = (Sales x P/V ratio) – 1,40,400  
=  $(6,48,000 \times 20\%) - 1,40,400 = 1,29,600 - 1,40,400$   
= ₹ 10,800 (loss)
4. Amount of sales to earn profit of ₹ 1,08,000 =  $(1,40,400 + 1,08,000) / 20\%$   
=  $2,48,400 / 20\% = ₹ 12,42,000$

**Problem 8**

The following figures relate to a company manufacturing a varied range of products:

	Total Sales (₹)	Total Cost (₹)
Year ended 31-12-2014	22,23,000	19,83,600
Year ended 31-12-2015	24,51,000	21,43,200

Assuming stability in prices, with variable cost carefully controlled to reflect pre-determined relation.

- (a) The profit volume ratio to reflect the rates of growth for profit and sales and
- (b) Any other cost figures to be deduced from the data.

**Answer:**

	31-12-2014 (₹)	31-12-2015 (₹)
Sales	22,23,000	24,51,000
(-) cost	19,83,600	21,43,200
Profit	2,39,400	3,07,800

Change in profit = 3,07,800 – 2,39,400 = ₹ 68,400

Change in sales = 24,51,000 – 22,23,000 = ₹ 2,28,000

(a) P/V ratio = (68,400 / 2,28,000) × 100 = 30%

(b) Fixed cost = (22,23,000 × 30%) – 2,39,400 = ₹ 4,27,500

(c) Break even sales = 4,27,500 / 30% = ₹ 14,25,000

(d) M/S for 2014 = 22,23,000 – 14,25,000 = ₹ 7,98,000

M/S for 2015 = 24,51,000 – 14,25,000 = ₹ 10,26,000

(e) Variable cost for 2014 = 22,23,000 × 70% = ₹ 15,56,100

Variable cost for 2015 = 24,51,000 × 70% = ₹ 17,15,700

(f) % of fixed cost in 2014 = (4,27,500 / 22,23,000) × 100 = 19.23%

% of fixed cost in 2015 = (4,27,500 / 24,51,000) × 100 = 17.44%

**Problem 9**

SV Ltd a multi product company furnishes you the following data relating to the year 2015:

	First Half of the year (₹)	Second Half of the year (₹)
Sales	45,000	50,000
Total cost	40,000	43,000

Assuming that there is no change in prices and variable cost and that the fixed expenses are incurred equally in the two half year period, calculate for the year, 2015

- (i) The P/V Ratio,
- (ii) Fixed Expenses
- (iii) Break-even sales
- (iv) Percentage of Margin of safety.

**Answer:**

(i) P/V ratio = [(7,000 – 5,000) / (50,000 – 45,000)] × 100 = 40%

(ii) Fixed expenses for first half year = (Sales × PV ratio) – Profit  
 = (45,000 × 0.4) – 5,000 = ₹ 13,000

Fixed expenses for the year = 13,000 + 13,000 = ₹ 26,000

(iii) Break even sales = 26,000 / 40% = ₹ 65,000



(iv) Margin of safety =  $(50,000 + 45,000) - 65,000 = ₹ 30,000$

Margin of safety ratio =  $[30,000 / (50,000 + 45,000)] \times 100 = 31.58\%$

### Problem 10

S Ltd. furnishes you the following information relating to the half year ended 30th June, 2015.

	(₹)
Fixed expenses	45,000
Sales value	1,50,000
Profit	30,000

During the second half the year the company has projected a loss of ₹10,000.

Calculate:

- (1) The B.E.P and M/S for six months ending 30th June, 2015.
- (2) Expected sales volume for the second half of the year assuming that the P/V Ratio and Fixed expenses remain constant in the second half year also.
- (3) The B.E.P and M/S for the whole year for 2015.

### Solution:

- (1) P/V ratio : =  $[(45,000 + 30,000) / 1,50,000] \times 100 = 50\%$

BE sales for I half year =  $45,000 / 50\% = ₹ 90,000$

Margin of safety for I half year =  $1,50,000 - 90,000 = ₹ 60,000$

For II half year:

- (2) P/V ratio =  $(\text{Fixed cost} + \text{Profit}) / \text{Sales}$

$0.5 = [45,000 + (-) 10,000] / \text{Sales}$

$0.5 \text{ sales} = 35,000$

$\therefore \text{Sales} = ₹ 70,000$

- (3) BE sales for 2015 =  $(45,000 + 45,000) \times 50\% = 1,80,000$

Margin of safety for 2015 =  $(1,50,000 + 70,000) - 1,80,000 = ₹ 40,000$

### Problem 11

The following is the statement of a Radical Co. for the month of June.

	Products		Total
	L (₹)	M (₹)	(₹)
Sales	60,000	60,000	1,20,000
Variable costs	42,000	30,000	72,000
Contribution	18,000	30,000	48,000
Fixed cost			36,000
Net Income			12,000



You are required to compute the P/V ratio for each product and then compute the P/V Ratio, Breakeven Point and net profit for the following assumption.

(i) Sales revenue divided 60% to Product L & 40% to Product M.

(ii) Sales revenue divided 40% to Product L & 60% to Product M.

Also calculate the profit estimated on sales upto ₹ 1,80,000/- p.m. for each of the sales mix provided above.

**Answer:**

**Computation of P/V ratio**

Particulars	L	M	Total
P/V ratio (C/S) x 100	30%	50%	40%

**(i) For Assumption I**

Statement showing computation of P/V ratio, Breakeven point and profit:

Sr. No.	Particulars	L	M	Total
(i)	Sales	72,000	48,000	1,20,000
(ii)	Variable cost (L - 70%); (M - 50%)	50,400	24,000	74,400
(iii)	Contribution (L - 30%); (M - 50%)	21,600	24,000	45,600
(iv)	Fixed cost			36,000
(v)	Profit			9,600
P/V ratio $(45,600 \times 1,20,000) / 100 = 38\%$		30%	50%	38%
Break even sales = $36,000 / 38\% = ₹ 94,737$				

**(ii) For Assumption II**

Statement showing computation of P/V ratio, Breakeven point and profit:

Sr. No.	Particulars	L	M	Total
(i)	Sales	48,000	72,000	1,20,000
(ii)	Variable cost (L - 70%); (M - 50%)	33,600	36,000	69,600
(iii)	Contribution (L - 30%); (M - 50%)	14,400	36,000	50,400
(iv)	Fixed cost			36,000
(v)	Profit			14,400
P/V ratio $(50,400 \times 1,20,000) / 100 = 42\%$		30%	50%	42%
Break even sales = $36,000 / 42\% = ₹ 85,714$				

**Problem 12**

Accelerate Co. Ltd., manufactures and sells four types of products under the brand names of A, B,

C and D. The sales Mix in value comprises  $33\frac{1}{3}\%$ ,  $41\frac{2}{3}\%$ ,  $16\frac{2}{3}\%$ , and  $8\frac{1}{3}\%$  of products A, B, C & D respectively.



The total budgeted sales (100% are ₹60,000 p.m.). Operating costs are:

Variable Costs:

Product A 60% of selling price

Product B 68% of selling price

Product C 80% of selling price

Product D 40% of selling price

Fixed Costs: ₹ 14,700 p.m.

- (a) Calculate the break - even - point for the products on overall basis and  
(b) Also calculate break-even-point, if the sales mix is changed as follows the total sales per month remaining the same. Mix: A - 25% : B - 40% : C - 30% : D - 5%.

**Answer:**

	Particulars	A (₹)	B (₹)	C (₹)	D (₹)	Total (₹)
(i)	Sales	20,000	25,000	10,000	5,000	60,000
(ii)	Variable cost	12,000	17,000	8,000	2,000	39,000
(iii)	Contribution	8,000	8,000	2,000	3,000	21,000
(iv)	Fixed cost					14,700
(v)	Profit					6,300
	P/V ratio (C/S) x 100	40%	32%	20%	60%	35%

(a) Break even sales

$$\text{Break even sales} = 14,700 / 35\% = ₹ 42,000$$

(b)

	Particulars	A (₹)	B (₹)	C (₹)	D (₹)	Total (₹)
(i)	Sales	15,000	24,000	18,000	3,000	60,000
(ii)	Variable cost	9,000	16,320	14,400	1,200	39,000
(iii)	Contribution	6,000	7,680	3,600	1,800	21,000
(iv)	Fixed cost					14,700
(v)	Profit					4,380
	P/V ratio (C/S) x 100	40%	32%	20%	60%	31.8%

$$\text{Break even sales} = 14,700 / 31.8\% = ₹ 46,226$$

### Problem 13

Present the following information to show to management:

- (i) The marginal product cost and the contribution p.u.  
(ii) The total contribution and profits resulting from each of the following sales mix results.





Particulars	Product	Per unit (₹)
Direct Materials	A	10
Direct Materials	B	9
Direct wages	A	3
Direct wages	B	2

Fixed Expenses – ₹ 800

(Variable expenses are allotted to products at 100% Direct Wages)

Sales Price ----- A ₹ 20

Sales Price ----- B ₹ 15

- Sales Mixtures:
- 100 units of Product A and 200 of B.
  - 150 units of Product A and 150 of B.
  - 200 units of Product A and 100 of B.

**Answer:**

**(i) Statement of Marginal Product cost**

	Particulars	A (₹)	B (₹)
(i)	Selling Price	20.00	15.00
(ii)	Variable cost		
	Direct Materials	10.00	9.00
	Direct wages	3.00	2.00
	Variable OHs (100% of direct wages)	3.00	2.00
		16.00	13.00
(iii)	Contribution (i – ii)	4.00	2.00

**(ii) Profit at Mix (a)**

Sr. No.	Particulars	A (₹)	B (₹)	Total (₹)
(i)	No. of units	100	200	
(ii)	'C' per unit	4	2	
(iii)	Total contribution (ii x i)	400	400	800
(iv)	Fixed cost			800
(v)	Profit (iii - iv)			Nil

**Profit at Mix (b)**

Sr. No.	Particulars	A (₹)	B (₹)	Total (₹)
(i)	No. of units	150	150	
(ii)	'C' per unit	4	2	
(iii)	Total contribution (ii x i)	600	300	900
(iv)	Fixed cost			800
(v)	Profit (iii - iv)			100

**Profit at Mix (c)**

Sr. No.	Particulars	A (₹)	B (₹)	Total (₹)
(i)	No. of units	200	100	
(ii)	'C' per unit	4	2	
(iii)	Total contribution (i x ii)	800	200	1000
(iv)	Fixed cost			800
(v)	Profit (iii - iv)			200

here 'C' means 'Contribution'.

**Problem 14**

The following particulars are extracted from the records of a company:

	PER UNIT	
	PRODUCT A	PRODUCT B
Sales (₹)	100	120
Consumption of material	2 Kg	3 Kg
Material cost (₹)	10	15
Direct wages cost (₹)	15	10
Direct expenses (₹)	5	6
Machine hours used	3 Hrs	2 Hrs
<b>Overhead expenses:</b>		
Fixed (₹)	5	10
Variable (₹)	15	20

Direct wages per hour is ₹ 5

(a) Comment on profitability of each product (both use the same raw material) when:

- 1) Total sales potential in units is limited;
- 2) Total sales potential in value is limited;
- 3) Raw material is in short supply;
- 4) Production capacity (in terms of machine hours) is the limiting factor.

(b) Assuming raw material as the key factor, availability of which is 10,000 Kgs. and each product cannot be sold more than 3,500 units find out the product mix which will yield the maximum profit.

**Answer:****(a) Statement showing computation of contribution per unit of different factors of production and determination of profitability**

	Particulars	A (₹)	B (₹)
(i)	Sales	100	120
(ii)	Variable cost		
	Materials	10	15
	Labour	15	10
	Direct expenses	5	6
	Variable OH	15	20
		45	51
(iii)	Contribution (i – ii)	55	69
(iv)	P/V ratio (iii – i)	55%	57.5%
(v)	Contribution per kg of material	$55/2 = 27.5$	$69/3 = 23$
(vi)	Contribution per machine hour	$55/3 = 18\frac{1}{3}$	$69/2 = 34.5$

From the above computations, we may comment upon the profitability in the following manner.

1. If total sales potential in units is limited, product B is more profitable, it has more contribution per unit.
2. When total sales in value is limited, product B is more profitable because it has higher P/V ratio.
3. If the raw material is in short supply, Product A is more profitable because it has more contribution per Kg of material.
4. If the production capacity is limited, product B is more profitable, because it has more contribution per machine hour.

**(b) Statement showing optimum mix under given conditions and computation of profit at that mix**

Sr. No.	Particulars	A (₹)	B (₹)	Total (₹)
(i)	No. of units	3,500	1,000	
(ii)	Contribution per unit	55	69	
(iii)	Total contribution	1,92,500	69,000	2,61,500
(iv)	Fixed cost (3500 × 5) (3500 × 100)	17,500	35,000	52,500
(v)	Profit			2,09,000

\* Fixed cost is taken at maximum capacity (3,500 × 10)

**Working Notes:**

	<b>Kg.</b>
Available material	= 10,000
(-) utilized for A (3,500 × 2)	= 7,000
	= 3,000
Units of B = 3,000 / 3 = 1,000	

**Problem 15**

A company has a capacity of producing 1 lakh units of a certain product in a month. The sales department reports that the following schedule of sales prices is possible.

VOLUME OF PRODUCTION	SELLING PRICE PER UNIT
%	(₹)
60	0.90
70	0.80
80	0.75
90	0.67
100	0.61

The variable cost of manufacture between these levels is 15 paise per unit and fixed cost ₹ 40,000. Prepare a statement showing incremental revenue and differential cost at each stage. At which volume of production will the profit be maximum?

**Answer:**

**Statement showing computation of differential cost, incremental revenue and determination of capacity at which profit is maximum**

Capacity	Units	Sales	V. Cost @ ₹ 0.15	Fixed Cost	Total cost	Differential Cost	Incremental Revenue
%		(₹)		(₹)	(₹)	(₹)	(₹)
60%	60,000	54,000	9,000	40,000	49,000	---	---
70%	70,000	56,000	10,500	40,000	50,500	1,500	2,000
80%	80,000	60,000	12,000	40,000	52,000	1,500	4,000
90%	90,000	60,300	13,500	40,000	53,500	1,500	300
100%	1,00,000	61,000	15,000	40,000	55,000	1,500	700

From the above computation, it was found that the incremental revenue is more than the differential cost up to 80% capacity, the profit is maximum at that capacity.

**Problem 16**

The operating statement of a company is as follows:

	₹	₹
Sales (80,000 @ ₹15 each)		12,00,000
Costs:		
Variable:		
Material	2,40,000	
Labour	3,20,000	
Overheads	1,60,000	
	7,20,000	
Fixed Cost	3,20,000	10,40,000
PROFIT		1,60,000



The capacity of the plant is 1 lakh units. A customer from U.S.A. is desirous of buying 20,000 units at a net price of ₹ 10 per unit. Advise the producer whether or not offer should be accepted. Will your advice be different, if the customer is local one.

**Answer:**

**Statement showing computation of profit before and after accepting the order**

Sr. No.	Particulars	Present Position (Before accepting 80,000) (₹)	Order Value (20,000) (₹)	Total (After accepting 1,00,000) (₹)
(i)	Sales	12,00,000	2,00,000	14,00,000
(ii)	Variable cost			
	Materials	2,40,000	60,000	3,00,000
	Labour	3,20,000	80,000	4,00,000
	Variable OH	1,60,000	40,000	2,00,000
		7,20,000	1,80,000	9,00,000
(iii)	Contribution (i – ii)	4,80,000	20,000	5,00,000
(iv)	Fixed Cost	3,20,000		3,20,000
(v)	Profit (iii – iv)	1,60,000	20,000	1,80,000

As the profit is increased by ₹ 20,000 by accepting the order, it is advised to accept the same. If the order is from local one, it should not be accepted because it will adversely affect the present market.

### Problem 17

A company manufactures scooters and sells it at ₹ 3,000 each. An increase of 17% in cost of materials and of 20% of labour cost is anticipated. The increased cost in relation to the present sales price would cause at 25% decrease in the amount of the present gross profit per unit.

At present, material cost is 50%, wages 20% and overhead is 30% of cost of sales.

You are required to:

- Prepare a statement of profit and loss per unit at present and;
- Compute the new selling price to produce the same percentage of profit to cost of sales as before.

**Answer:**

Let X and Y be the cost and profit respectively.

$$X + Y = 3,000 \quad \rightarrow (1)$$

$$\text{Material} = X \times 50/100 = 0.5X$$

$$\text{Labour} = X \times 20/100 = 0.2X$$

$$\text{Overheads} = X \times 30/100 = 0.3X$$

**After increase of cost:**

$$\text{Material} = 0.5 X \times 117/100 = 0.585 X$$

$$\text{Labour} = 0.2X \times 120/100 = 0.240 X$$

$$\text{Overheads} = 0.300 X$$

$$= 1.125 X$$



$$\text{Profit} = Y \times 75/100 = 0.75Y$$

$$\therefore \text{New Equation } 1.125X + 0.75Y = 3,000 \rightarrow (2)$$

$$\text{Multiplying Eq. (1) by } 0.75 \quad 0.75X + 0.75Y = 2,250$$

$$0.375X = 750$$

$$X = 750/0.375 = ₹ 2,000$$

$$Y = 3,000 - 2,000 = ₹ 1,000$$

#### Statement of cost & profit per unit at present

	(₹)
Material = 2,000 x 50%	1,000
Labour = 2,000 x 20%	400
Overheads = 2,000 x 30%	600
	2,000
(+) profit @ 50% of cost	1,000
	3,000

#### Computation of new selling price to get same percentage of profit

	(₹)
Material = 1,000 x 117/100	1,170
Labour = 400 x 120/100	480
Overheads	600
Cost	2,250
(+) Profit @ 50%	1,125
New selling price	3,375

#### Problem 18

An umbrella manufacturer marks an average net profit of ₹ 2.50 per piece on a selling price of ₹14.30 by producing and selling 6,000 pieces or 60% of the capacity. His cost of sales is

	(₹)
Direct material	3.50
Direct wages	1.25
Works overheads (50% fixed)	6.25
Sales overheads (25% variable)	0.80

During the current year, he intends to produce the same number but anticipates that fixed charges will go up by 10% which direct labour rate and material will increase by 8% and 6% respectively but he has no option of increasing the selling price. Under this situation, he obtains an offer for further 20% of the capacity. What minimum price you will recommend for acceptance to ensure the manufacturer an overall profit of ₹16,730.



**Answer:**

**Computation of profit at present after increase in cost**

Sr. No.	Particulars	(₹)
(i)	Selling price	14.30
(ii)	Variable cost	
	Material (3.5 x 106/100)	3.710
	Labour (1.25 x 108/100)	1.350
	Works overhead	3.125
	Sales overhead	0.200
		8.385
(iii)	Contribution per unit (I-II)	5.915
(iv)	Total contribution (6,000 x 5.915)	35,490
(v)	Fixed cost	
	Works OH 3.125	24,585
	Sales OH 0.600 (3.725 x 6,000 = 22,350 x 110/100)	
(vi)	Profit (iv - v)	10,905

**Computation of selling price of the order**

	₹
Variable cost of order (2,000 x 8.385)	16,770
(+) required profit (16,730 – 10,905)	5,825
Sales required	22,595

Selling price of order =  $22,595/2,000 = 11.2975$  (or) ₹ 11.30

**Problem 19**

The Dynamic company has three divisions. Each of which makes a different product. The budgeted data for the coming year are as follows:

	A (₹)	B (₹)	C (₹)
Sales	1,12,000	56,000	84,000
Direct Material	14,000	7,000	14,000
Direct Labour	5,600	7,000	22,400
Direct Expenses	14,000	7,000	28,000
Fixed Cost	28,000	14,000	28,000
	61,600	35,000	93,400

The Management is considering to close down the division C'. There is no possibility of reducing fixed cost. Advise whether or not division C' should be closed down.



**Answer:**

**Statement showing computation of profit before closing down of division C**

Sr. No.	Particulars	A (₹)	B (₹)	C (₹)	Total (₹)
(i)	Sales	1,12,000	56,000	84,000	2,52,000
(ii)	Variable cost				
	Direct Materials	14,000	7,000	14,000	35,000
	Direct Labour	5,600	7,000	22,400	35,000
	Direct Expenses	14,000	7,000	28,000	49,000
(iii)	Total Variable Cost	33,600	21,000	64,400	1,19,000
(iv)	Contribution (i – iii)	78,400	35,000	19,600	1,33,000
(v)	Fixed Cost				70,000
(vi)	Profit (iv – v)				63,000

**Statement showing computation of profit after closing 'C'**

Sr. No.	Particulars	A (₹)	B (₹)	Total (₹)
(i)	Sales	1,12,000	56,000	1,68,000
(ii)	Variable cost			
	Direct Materials	14,000	7,000	21,000
	Direct Labour	5,600	7,000	12,600
	Direct Expenses	14,000	7,000	21,000
(iii)	Total Variable Cost	33,600	21,000	54,600
(iv)	Contribution (i – iii)	78,400	35,000	1,13,400
(v)	Fixed Cost			70,000
(vi)	Profit (iv – v)			43,400

From the above computations, it was found that profit is decreased by ₹ 19,600 by closing down division 'C', it should not be closed down. In other words, as long as if there is a contribution of ₹ 1, from division 'C', it should not be closed down.

**Problem 20**

Mr. Young has ₹ 1,50,000 investment in a business. He wants a 15% profit on his money. From an analysis of recent cost figures he finds that his variable cost of operating is 60% of sales; his fixed costs are ₹75,000 per year. Show supporting computations for each answer.

- What sales volume must be obtained to break-even?
- What sales volume must be obtained to his 15% return on investment?
- Mr. Young estimates that even if he closed the doors of his business he would incur ₹25,000 expenses per year. At what sales would be better off by locking his sales up?



**Answer:**

P/V ratio (V. cost ratio 60%) = 40%

(a) Break even sales = 75,000 / 40% = ₹ 1,87,500

(b) Required sales to get desired income = (75,000 + 22,500) / 40% = ₹ 2,43,750

(c) Shut down sales = Fixed cost – shut down cost = P/V Ratio = (75,000 – 25,000) / 40%  
= ₹ 1,25,000

**Problem 21**

The manager of a Co. provides you with the following information:

	₹
Sales	4,00,000
Costs: Variable (60% of sales)	
Fixed cost	80,000
Profit before tax	80,000
Income-tax	
Net profit	32,000

The company is thinking of expanding the plant. The increased fixed cost with plant expansion will be ₹40,000. It is estimated that the maximum production in new plant will be worth ₹2,40,000. The company also wants to earn additional income ₹ 3,200 on investment. On the basis of computations give your opinion on plant expansion.

**Answer:****Statement showing computation of profit before and after plant expansion**

Sr. No.	Particulars	Present (Before expansion)(₹)	Expansion Value (₹)	Total (After expansion) (₹)
(i)	Sales	4,00,000	2,40,000	6,40,000
(ii)	Variable cost (60%)	2,40,000	1,44,000	3,84,000
(iii)	Contribution (i – ii)	1,60,000	96,000	2,56,000
(iv)	Fixed Cost	80,000	40,000	1,20,000
(v)	Profit before tax (iii – iv)	80,000	56,000	1,36,000
(vi)	Profit after tax (V × 0.40)	32,000	22,400	54,400

From the above computations, it was found that the profit is increased by ₹ 22,400 by expanding the plant, which is much higher than the expected income of ₹ 3,200, one's opinion should be in favour of plant expansion.

**Problem 22**

A manufacturer with overall (interchangeable among the products) capacity of 1,00,000 machine hours has been so far producing a standard mix of 15,000 units of product A, 10,000 units of product B and C each. On experience, the total expenditure exclusive of his fixed charges is found to be ₹ 2.09 lakhs and the cost ratio among the product approximately 1, 1.5, 1.75 respectively per unit. The fixed



charges comes to ₹ 2 per unit. When the unit selling prices are ₹ 6.25 for A, ₹ 7.5 for B and ₹10.5 for C. He incurs a loss.

	Mix-I	Mix-II	Mix-III
A	18,000	15,000	22,000
B	12,000	6,000	8,000
C	7,000	13,000	8,000

As a management accountant what mix will you recommend?

**Answer:**

Let variable cost per unit of A, B, C be ₹ X, ₹ 1.5X and ₹ 1.75X respectively.

$$A = 15,000 \times X = 15,000 X$$

$$B = 10,000 \times 1.5X = 15,000 X$$

$$C = 10,000 \times 1.75X = 17,500 X$$

$$\text{Total variable cost} = 47,500 X$$

So, we can say,

$$47,500 X = 2,09,000$$

or,  $X = 4.4$

Variable cost per unit of A = X = ₹ 4.4

Variable cost per unit of B = 1.5 (4.4) = ₹ 6.6

Variable cost per unit of C = 1.75 (4.4) = ₹ 7.7

**Statement showing computation of loss at present mix**

	Particulars	A (₹)	B (₹)	C (₹)	Total (₹)
(i)	Selling price	6.25	7.50	10.50	
(ii)	Variable Cost	4.40	6.60	7.70	
(iii)	Contribution	1.85	0.90	2.80	
(iv)	No. of units at present mix	15,000	10,000	10,000	
(v)	Total contribution	27,750	9,000	28,000	64,750
(vi)	Fixed cost (35,000 × 2)				70,000
(vii)	Loss				5,250

**Computation of Profit/(loss) at Mix I**

	Particulars	A (₹)	B (₹)	C (₹)	Total (₹)
(i)	No. of units	18,000	12,000	7,000	
(ii)	Contribution per unit	1.85	0.90	2.80	
(iii)	Total contribution	33,300	10,800	19,600	63,700
(iv)	Fixed Cost (15,000 + 10,000 + 10,000) × 2				70,000
(v)	Loss				6,300



### Computation of Profit/(loss) at Mix II

	Particulars	A (₹)	B (₹)	C (₹)	Total (₹)
(i)	No. of units	15,000	6,000	13,000	
(ii)	Contribution per unit	1.85	0.90	2.80	
(iii)	Total contribution	27,750	5,400	36,400	69,550
(iv)	Fixed Cost (15,000 + 10,000 + 10,000) × 2				70,000
(v)	Loss				450

### Computation of Profit/(loss) at Mix III

	Particulars	A (₹)	B (₹)	C (₹)	Total (₹)
(i)	No. of units	22,000	8,000	8,000	
(ii)	Contribution per unit	1.85	0.90	2.80	
(iii)	Total contribution	40,700	7,200	22,400	70,300
(iv)	Fixed Cost (15,000 + 10,000 + 10,000) × 2				70,000
(v)	Profit				300

As management accountant, one should recommend Mix III because there is profit of ₹ 300 against loss at other mixes including present mix.

### Problem 23

A Co. has annual fixed costs of ₹ 1,40,000. In 2015 sales amounted to ₹6,00,000, as compared with ₹4,50,000 in 2014, and profit in 2015 was ₹ 42,000 higher than that in 2014.

- At what level of sales does the company break-even?
- Determine profit or loss on a forecast sales volume of ₹ 8,00,000
- If there is a reduction in selling price by 10% in 2016 and the company desires to earn the same amount of profit as in 2015, what would be the required sales volume?

### Answer:

$$\begin{aligned}
 \text{P/V ratio} &= (\text{Change in profit} / \text{Change in sales}) \times 100 \\
 &= (42,000 / 1,50,000) \times 100 \\
 &= 28\%
 \end{aligned}$$

$$\begin{aligned}
 \text{(i) Break even sales} &= \text{Fixed cost} / \text{PV ratio} \\
 &= 1,40,000 / 28\% \\
 &= ₹ 5,00,000
 \end{aligned}$$

$$\begin{aligned}
 \text{(ii) Profit} &= (8,00,000 \times 0.28) - 1,40,000 \\
 &= 2,24,000 - 1,40,000 \\
 &= ₹ 84,000
 \end{aligned}$$



(iii) Profit in 2015 being desired profit =  $(6,00,000 \times 0.28) - 1,40,000$   
=  $1,68,000 - 1,40,000$   
= ₹ 28,000

Assuming same quantity of sales as in 2015 is also made in 2016, then sales would be ₹  $6,00,000 \times 90/100$   
= ₹ 5,40,000

Consequently contribution is ₹ 1,08,000 ( $1,68,000 - 60,000$ )

New P/V ratio =  $(1,08,000 / 5,40,000) \times 100 = 20\%$

Required sales to get the same profit as in 2012 =  $(1,40,000 + 28,000) / 20\% = 8,40,000$

(or)

	2015		2016
SP	100	SP	90
C	28	V	72
V	72	C	18

P/V ratio =  $(18/90) \times 100 = 20\%$ .

#### Problem 24

A Co. currently operating at 80% capacity has the following; profitability particulars:

	₹	₹
Sales		12,80,000
Costs:		
Direct Materials	4,00,000	
Direct labour	1,60,000	
Variable Overheads	80,000	
Fixed Overheads	5,20,000	11,60,000
Profit:		1,20,000

An export order has been received that would utilise half the capacity of the factory. The order has either to be taken in full and executed at 10% below the normal domestic prices, or rejected totally.

The alternatives available to the management are given below:

- Reject order and Continue with the domestic sales only, as at present;
- Accept order, split capacity equally between overseas and domestic sales and turn away excess domestic demand;
- Increase capacity so as to accept the export order and maintain the present domestic sales by:
  - buying an equipment that will increase capacity by 10% and fixed cost by ₹40,000 and
  - Work overtime a time and a half to meet balance of required capacity.

Prepare comparative statements of profitability and suggest the best alternative.



**Answer:**

**Statement showing computation of profit at present and at proposed two alternatives**

Sr. No.	Particulars	Present 80%	Foreign 50% Domestic 50% = 100%	50% Foreign + 80% Domestic = 130%
(i)	Sales	12,80,000	15,20,000	20,00,000
(ii)	Variable cost			
	Direct material	4,00,000	5,00,000	6,50,000
	Direct wages	1,60,000	2,00,000	2,60,000
	Variable OH	80,000	1,00,000	1,30,000
	Add. OT cost	---	---	20,000
(iii)	Total Variable cost	6,40,000	8,00,000	10,60,000
(iv)	Contribution (i – ii)	6,40,000	7,20,000	9,40,000
(v)	Fixed Cost	5,20,000	5,20,000	5,60,000
(VI)	Profit (iv – v)	1,20,000	2,00,000	3,80,000

As the profit is more at the Alternative III, i.e. accepting foreign order fully and maintaining present domestic sales fully, it is the best alternative to be suggested.

Overtime cost =  $(80,000 \times \frac{20\%}{80\%}) = ₹ 20,000$ .

**Problem 25**

A Company has just been incorporated and plan to produce a product that will sell for ₹ 10 per unit. Preliminary market surveys show that demand will be around 10,000 units per year.

The company has the choice of buying one of the two machines 'A' would have fixed costs of ₹ 30,000 per year and would yield a profit of ₹ 30,000 per year on the sale of 10,000 units. Machine 'B' would have fixed costs ₹18,000 per year and would yield a profit of ₹ 22,000 per year on the sale of 10,000 units. Variable costs behave linearly for both machines.

Required to:

- Break-even sales for each machine
- Sales level where both machines are equally profitable
- Range of sales where one machine is more profitable than the other.

**Answer:**

**Statement showing computation of Break Even sales for each machine and other required information**

Sr. No.	Particulars	A	B
(i)	Selling price (₹)	10	10
(ii)	No. of units (₹)	10,000	10,000
(iii)	Sales (₹) (i × ii)	1,00,000	1,00,000
(iv)	Fixed cost (₹)	30,000	18,000
(v)	Profit (₹)	30,000	22,000
(vi)	Contribution (₹)	60,000	40,000
(vii)	Variable cost (S – C) (₹)	40,000	60,000
(viii)	Variable cost per unit (₹) (vii / ii)	4	6
(ix)	Contribution per unit (₹) (vi / ii)	6	4



## 1. Break even sales:

$$A = 30,000 / 6 = 5,000 \text{ units (or) ₹ 50,000}$$

$$B = 18,000 / 4 = 4,500 \text{ units (or) ₹ 45,000}$$

## 2. Sales level where both machines are equally profitable (or) Breakeven level (or) indifference level = difference in Fixed cost / difference in VC per unit.

$$= (30,000 - 18,000) / (6 - 4)$$

$$= 12,000 / 2$$

$$= 6,000 \text{ units}$$

## 3. For sales level of 6,000 and above units, Machine A would be more profitable because its variable cost per unit is less. For sales level below 6,000 units, Machine B would be more profitable because its fixed cost is less than the fixed cost of Machine A

**Problem 26**

A practicing Cost Accountant now spends ₹ 0.90 per k.m. on taxi fares for his client's work. He is considering to other alternatives the purchase of a new small car or an old bigger car.

Item	New Small Car	Old bigger Car
Purchase price (₹)	35,000	20,000
Sale price after 5 years (₹)	19,000	12,000
Repairs and servicing per annum (₹)	1,000	1,200
Taxes and insurance p.a. (₹)	1,700	700
Petrol consumption per liter (K.m.)	10	7
Petrol price per liter (₹)	3.5	3.5

He estimates that he does 10,000 K.m. annually. Which of the three alternatives will be cheaper? If his practice expands he has to do 19,000 Km p.a. which is cheaper? Will cost of the two cars break even and why? Ignore interest and Income-tax.

**Answer:****Statement showing computation of comparative cost of three alternatives**

	Taxi (₹)	New Small car (₹)	Old Bigger Car (₹)
Fixed Costs:			
Depreciation (1,35,000 - 19,000/5); (2,00,000 - 12,000/5)	---	3,200	1,600
Repairs & Servicing	---	1,000	1,200
Taxes & Insurance	---	1,700	700
		5,900	3,500
Variable cost:			
Petrol per km.	0.90	0.35	0.5
Cost at 10,000 kms.	9,000 (10,000 × 0.9)	9,400 [5,900+(10,000×0.35)]	8,500 [3,500+(10,000×0.5)]
Cost at 19,000 kms.	17,100 (19,000 × 0.9)	12,550 [5,900+(19,000×0.35)]	13,000 [3,500+(19,000×0.5)]



(i) At 10,000 kms, old bigger car is cheaper.

(ii) At 19,000 kms, new smaller car is cheaper.

The distance at which cost of two cars is equal is =  $(5,900 - 3,500) / (0.5 - 0.35) = 16,000$  Kms

Indifference point for firm's old bigger car and taxi =  $3500 / 0.4 = 8,750$  kms

Indifference point for firm's new small car and taxi =  $5,900 / 0.55 = 10,727$  kms

### Problem 27

There are two plants manufacturing the same products under one corporate management which decides to merge them.

	PLANT - I	PLANT - II
Capacity operation	100%	60%
Sales (₹)	6,00,00,000	2,40,00,000
Variable costs (₹)	4,40,00,000	1,80,00,000
Fixed Costs (₹)	80,00,000	40,00,000

You are required to calculate for the consideration of the Board of Directors

- What would be the capacity of the merged plant to be operated for the purpose of break-even?
- What would be the profitability on working at 75% of the merged capacity.

### Answer:

#### Statement showing computation of Breakeven of merged plant and other required information

(₹ in lakhs)

Sr. No.	Particulars	Plant I		Plant II		Merged Plant (100%)
		Before (100%)	After (100%)	Before (60%)	After (100%)	
(i)	Sales	600	600	240	400	1000
(ii)	Variable cost	440	440	180	300	740
(iii)	Contribution (i - ii)	160	160	60	100	260
(iv)	Fixed Cost	80	80	40	40	120
(v)	Profit (iii - iv)	80	80	20	60	140

(a) Breakeven sales of merged plant =  $(120 \times 1,000) / 260 = 461.5384615$  lakhs

For 1,000 - 100%

For 461.5384615 - ?

=  $(100 / 1000) \times 461.5384615 = 46.15384615\%$

(b) Sales at 75% capacity =  $1,000 \times (75/100) = 750$  lakhs

Profit =  $(750 \times 0.26) - 120 = 75$  Lakhs

**Problem 28**

The particulars of two plants producing an identical product with the same selling price are as under:

	PLANT - A	PLANT - B
Capacity utilisation	70%	60%
	(₹ in lakhs)	(₹ in lakhs)
Sales	150	90
Variable Costs	105	75
Fixed costs	30	20

It has been decided to merge plant B with Plant A. The additional fixed expenses involved in the merger amount to is ₹ 2 lakhs.

Required:

1. Find the break-even-point of plant A and plant B before merger and the break-even point of the merged plant.
2. Find the capacity utilisationsation of the integrated plant required to earn a profit of ₹ 18 lakhs.

**Answer:**

**Statement showing computation of profit before and after merger and other required information**

(₹ in lakhs)

Sr. No.	Particulars	Plant A		Plant B		Merged (100%)
		Before (70%)	After (100%)	Before (60%)	After (100%)	
(i)	Sales	150	214.2857	90	150	364.2857
(ii)	Variable cost	105	150.0000	75	125	275.0000
(iii)	Contribution	45	64.2857	15	25	89.2857
(iv)	Fixed Cost	30	30.0000	20	20	52.0000
(v)	Profit / (Loss)	15	34.2857	(5)	5	37.2857
	Break even before merger	$(30 \times 150) / 45 = 100$ lakhs		$(20 \times 90) / 15 = 120$ lakhs		$52 \times 364.2857 / 89.2857 = 212.16$ lakhs

$$P/V \text{ Ratio} = (89.2857 / 364.2857) \times 100 = 24.5098 \%$$

$$\text{Required sales} = (52 + 18) / 0.245098 = 285.6$$

For 364.2857 - 100

For 285.6 - ?

$$\text{Capacity} = (100 / 364.2857) \times 285.6 = 78.4\%$$

**Problem 29**

A company engaged in plantation activities has 200 hectors of virgin land which can be used for growing jointly or individually tea, coffee and cardamom, the yield per hector of the different crops and their selling prices per Kg. are as under:





	Yield in Kgs.	Selling price per Kg. (₹)
Tea	2,000	20
Coffee	500	40
Cardamom	100	250

The relevant data are given below:

	Tea	Coffee	Cardamom
Labour charges ₹	8	10	120
Packing materials ₹	2	2	10
Other costs ₹	4	1	20
	14	13	150

(b) Fixed costs per annum:

	₹
Cultivation and growing cost	10,00,000
Administrative cost	2,00,000
Land Revenue	50,000
Repairs and maintenance	2,50,000
Other costs	3,00,000
Total Cost	18,00,000

The policy of the company is to produce and sell all three kinds of products and the maximum and minimum area to be cultivated per product is as follows:

	Hectors	
	Maximum	Minimum
Tea	160	120
Coffee	50	30
Cardamom	30	10

Calculate the most profitable product mix and the maximum profit which can be achieved.

**Answer:**

**Statement showing computation of contribution per hectare and determination of priority for profitability**

		Tea (₹)	Coffee (₹)	Cardamom (₹)
(i)	Sales realisation per hectare	40,000	20,000	25,000
(ii)	Variable cost	28,000	6,500	15,000
(iii)	Contribution	12,000	13,500	10,000
(iv)	Priority	II	I	III

**Statement showing optimum mix under given conditions and computation of profit at that mix**

	Particulars	Tea (₹)	Coffee (₹)	Cardamom (₹)	Total (₹)
	Minimum area to be produced (hectars)	120	30	10	160
	Remaining land (hectars)	20 (ii)	20 (i)		40
(i)	No. of hectares	140	50	10	200
(ii)	Contribution per hectares (₹)	12,000	13,500	10,000	
(iii)	Total Contribution (₹)	16,80,000	6,75,000	1,00,000	24,55,000
(iv)	Fixed Cost (₹)				18,00,000
(v)	Profit (₹)				6,55,000

**Problem 30**

A Co. running an adequate supply of labour presents the following data requests your advice about the area to be allotted for the cultivation of various types of fruits which would result in the maximization of profits. The company contemplates growing Apples Lemons Oranges and Peaches.

	APPLES	LEMONS	ORANGES	PEACHES
Selling price per box (₹)	15	15	30	45
Seasons yield box per acre	500	150	100	200
	Cost in Rupees:			
Material per acre	270	105	90	150
Growing per acre labour	300	225	150	195
Picking & Packing per box	1.5	1.5	3	4.5
Transport per box	3.00	3.00	1.5	4.5

The fixed costs in each season would be:

Cultivation & Growing ₹56,000: Picking ₹42,000

Transport - ₹10,000: Administration-₹84,000

Land Revenue - ₹18,000

The following limitations are also placed before you:

- The area available is 450 acres, but out of this 300 acres are suitable for growing only Oranges and Lemons. The balance of 150 acres is suitable for growing for any of the four fruits viz., Apples, Lemons, Oranges and Peaches.
- As the products may be hypothecated to banks, area allotted for any fruit should be demarcated in complete acres and not in fractions of an acre.
- The marketing strategy of the company requires the compulsory production of all the four types of fruits in a season and the minimum quantity of any type to be 18,000 boxes.

Calculate the total profits that would accrue if your advice is accepted.

**Answer:****Statement showing computation of contribution per acre and determination of priority for profitability**

Sr. No.	Particulars	APPLES (₹)	LEMONS (₹)	ORANGES (₹)	PEACHES (₹)
(i)	Sales value per acre (₹)	7,500	2,250	3,000	9,000
(ii)	Variable cost				
	Material	270	105	90	150
	Growing labour	300	225	150	195
	Pickings & Packing labour	750	225	300	900
	Transport	1,500	450	150	900
		2,820	1,005	690	2,145
(iii)	Contribution	4,680	1,245	2,310	6,855
	Priority	II	IV	III	I

Statement showing optimum mix under given conditions and computation of profit at that mix:

	Particulars	Apples (₹)	Lemons (₹)	Oranges (₹)	Peaches (₹)	Total (₹)
	Minimum production in boxes	18,000	18,000	18,000	18,000	
	Area utilized for these minimum	36	120	180	90	426
	Remaining area				24	24
(i)	No. of area	36	120	180	114	450
(ii)	Contribution per acre	4,680	1,245	2,310	6,855	
(iii)	Total contribution	1,68,480	1,49,400	7,15,800	7,81,470	15,15,150
(iv)	Fixed cost					2,10,000
(v)	Profit					13,05,150

**Problem 31**

A market gardener is planning his production for next season and he asked you, as a cost consultant, to recommend the optimum mix of vegetable production for the coming year. He has given you the following data relating to the current year:

	POTATOES	TOMATOES	PEAS	CARROTS
Area occupied in acres	25	20	30	25
Yield per acre in tons	10	8	90	12
Selling Price per ton (₹)	1,000	1,250	1,500	1,350
<b>Variable Cost per acre:</b>				
Fertilizer	300	250	450	400
Seeds	150	200	300	250
Pesticides	250	150	200	250
Direct Wages	4,000	4,500	5,000	5,700

Fixed Overhead per annum: ₹5,40,000



The land which is being used for the production of carrots and peas can be used for either crop but not for potatoes and tomatoes. The land being used for potatoes and tomatoes can be used for either crops but not carrots and peas. In order to provide an adequate market service, the gardener must produce each year at least 40 tons of each of potatoes and tomatoes and 36 tons of each peas and carrots. You are required to present a statement to show :

- (a) (1) The profit for the current year:  
 (2) The profit for the production mix you would recommend;
- (b) Assuming that the land could be cultivated in such a way that any of the above crops could be produced and there was no market commitment. You are required to:
- (1) Advise the market gardener on which crop he should concentrate his production.  
 (2) Calculate the profit if he were to do so, and  
 (3) Calculate in rupees the breakeven - point of sales.

**Answer:**

**Statement showing computation of contribution and determination of priority for profitability**

	Particulars	Potatoes	Tomatoes	Peas	Carrots
(i)	Sales per acre (₹)	10,000	10,000	13,500	16,200
(ii)	Variable cost (₹)	4,700	5,100	5,950	6,600
(iii)	Contribution (₹)	5,300	4,900	7,550	9,600
(iv)	Priority	III	IV	II	I

(a)

**(1) Statement showing computation of profit for current year**

Sl. No.	Particulars	Potatoes	Tomatoes	Peas	Carrots	Total
I	No. of acres	25	20	30	25	100
II	Contribution per acre (₹)	5,300	4,900	7,550	9,600	
III	Total contribution (₹)	1,32,500	98,000	2,26,500	2,40,000	6,97,000
IV	Fixed cost (₹)					5,40,000
V	Profit (₹)					1,57,000

**(2) Statement showing optimum mix under given conditions and computation of profit at that mix**

Sl. No.	Particulars	Potatoes	Tomatoes	Peas	Carrots	Total
	Minimum production in tons	40	40	36	36	100
	Area required for this (acre)	4	5	4	3	16
	Remaining area (acre)	36	---	---	48	84
I	No. of acres	40	5	4	51	
II	Contribution per acre (₹)	5,300	4,900	7,550	9,600	
III	Total contribution (₹)	2,12,000	24,500	30,200	4,89,600	7,56,300
IV	Fixed cost (₹)					5,40,000
V	Profit (₹)					2,16,300



(b) (1) If the land is suitable for growing any of the crops and there is no market commitment, the gardener is advised to concentrate his production on carrots.

**(2) & (3):**

Sl. No.	Particulars	₹
I	Sales (16,200 x 100)	16,20,000
II	Contribution (9,600 x 100)	9,60,000
III	Fixed cost	5,40,000
IV	Profit	4,20,000

$$\text{Break even sales} = (5,40,000 \times 16,20,000) / 9,60,000 = ₹ 9,11,250$$

### Problem 32

Small Tools Factory has a plant capacity adequate to provide 19,800 hours of machine use. The plant can produce all A type tools or all B type tools or a mixture of these two type. The following information is relevant

	A	B
Selling price (₹)	10	15
Variable cost (₹)	8	12
Hours required to produce	3	4

Market conditions are such that not more than 4,000 A type tools and 3,000 B type tools can be sold in a year. Annual fixed costs are ₹ 9,900.

Compute the product mix that will maximise the net income to the company and find that maximum net income.

**Answer:**

**Statement showing computation of contribution per machine hour and determination of priority for profitability**

Sl. No.	Particulars	A	B
I	Selling price (₹)	10	15
II	Variable cost (₹)	8	12
III	Contribution (₹)	2	3
IV	Contribution per machine hour (₹)	2/3 = 0.67	3/4 = 0.75
	Priority	II	I

**Statement showing optimum mix under given conditions and computation of profit at that mix**

Sl. No.	Particulars	A	B	Total
I	No. of units	2,600	3,000	
II	Contribution per unit (₹)	2	3	
III	Total contribution (₹)	5,200	9,000	14,200
IV	Fixed cost (₹)			9,900
V	Profit			4,300



Available hours                    19,800  
 (-) Hours for B (3,000 x 4) 12,000  
     7,800  
 Units of A = 7,800 / 3 = 2,600

**Problem 33**

Taurus Ltd. produces three products A, B and C from the same manufacturing facilities. The cost and other details of the three products are as follows:

	A	B	C
Selling price per unit (₹)	200	160	100
Variable cost per unit (₹)	120	120	40
Fixed expenses/month (₹)			2,76,000
Maximum production per month (units)	5,000	8,000	6,000
Total hours available for the month			200
Maximum demand per month (units)	2,000	4,000	2,400

The processing hour cannot be increased beyond 200 hrs per month.

You are required to:

- Compute the most profitable product-mix.
- Compute the overall break-even sales of the co., for the month based in the mix calculated in (a) above.

**Answer:****(a) Statement showing computation of contribution per hour and determination of priority for profitability**

Sl. No.	Particulars	A	B	C
I	Selling price (₹)	200	160	100
II	Variable cost (₹)	120	120	40
III	Contribution (₹)	80	40	60
IV	No. of units per hour assuming only one product is made during the month	5,000/200 = 25	8,000/200 = 40	6,000 / 200 = 30
V	Contribution per hour (₹)	25×80 = 2,000	40×40 = 1,600	30×60 = 1,800
	Priority	I	III	II

**Statement showing optimum mix under the given conditions and computation of profit at that mix**

Sl. No.	Particulars	A	B	C	Total
I	No. of units	2,000	1,600	2,400	
II	Sales (₹)	4,00,000	2,56,000	2,40,000	8,96,000
III	Total contribution (₹)	1,60,000	64,000	1,44,000	3,68,000
IV	Fixed Cost (₹)				2,76,000
V	Profit (₹)				92,000



(b) Break even sales =  $(2,76,000 \times 8,96,000) / 3,68,000 = ₹ 6,72,000$

**Notes:**

Available hours	200
(-) Hours for A (2,000/25)	80
	120
(-) Hours for C (2,400/30)	80
	40

Units of B =  $40 \times 40 = 1,600$

**Problem 34**

A factory budget for a production of 1,50,000 units. The variable cost per unit is ₹ 14 and fixed cost is ₹ 2 per unit. The company fixes its selling price to fetch a profit of 15% on cost.

- What is the breakeven point?
- What is the profit volume ratio?
- If it reduces its selling price by 5% how does the revised selling price affect the BEP and the profit volume ratio?
- If a profit increase of 10% is desired more than the budget what should be the sale at the reduced prices?

**Answer:**

	₹
Variable cost	14
Fixed cost	2
Total cost	16
(+) Profit @ 15%	2.40
Selling price	18.40

Sl. No.	Particulars	₹
I	Selling price	18.40
II	Variable cost	14.00
III	Contribution	4.40
IV	Total contribution (1,50,000 x 4.4)	6,60,000
V	Fixed cost (1,50,000 x 2)	3,00,000
VI	Profit	3,60,000

(a) BEP =  $3,00,000 / 4.4 = 68,182$  units

(b) P/V ratio =  $(4.4 / 18.4) \times 100 = 23.91\%$



(c)

Sl. No.	Particulars	₹
I	Selling price (18.4 × 95%)	17.48
II	Variable cost	14.00
III	Contribution	3.48
IV	P/V ratio (3.48 / 17.48) × 100	19.908%
V	Breakeven point = 3,00,000 / 3.48	86,207 units

(d) Desired profit = 3,60,000 × (110/100) = ₹ 3,96,000

Sales required = (3,00,000 + 3,96,000) / 3.48 × 17.48 = ₹ 34,96,000.

**Problem 35**

VINAYAK LTD. which produces three products furnishes you the following information for 2015-16:

	PRODUCTS		
	A	B	C
Selling price per unit (₹)	100	75	50
Profit volume ratio %	10	20	40
Maximum sales potential units	40,000	25,000	10,000
Raw Material content as % of variable cost	50	50	50

The expenses - fixed are estimated at ₹6,80,000. The company uses a single raw material in all the three products. Raw material is in short supply and the company has a quota for the supply of raw materials of the value of ₹ 18,00,000 for the year 2011-12 for the manufacture of its products to meet its sales demand.

You are required to:-

- Set a product mix which will give a maximum overall profit keeping the short supply of raw material in view.
- Compute that maximum profit.

**Answer:****Statement showing computation of contribution per rupee of material and determination of priority for profitability**

Sl. No.	Particulars	A	B	C
I	Selling price (₹)	100	75	50
II	Contribution (₹)	10	15	20
III	Variable cost (₹)	90	60	30
IV	Raw material cost (₹)	45	30	15
V	Contribution per rupee of material (₹)	(10/45)=0.22	(15/30)=0.50	(20/15)=1.33
	Priority	III	II	I



**Statement showing optimum mix under given conditions and computation of profit at that mix**

Sl. No.	Particulars	A	B	C	Total
I	No. of units	20,000	25,000	10,000	
II	Contribution per unit (₹)	10	15	20,000	
III	Total contribution (₹)	2,00,000	3,75,000	2,00,000	7,75,000
IV	Fixed Cost (₹)				6,80,000
V	Profit (₹)				95,000

Available material	18,00,000
(-) Material for C (10,000 x 15)	1,50,000
	16,50,000
(-) Material for B (25,000 x 30)	7,50,000
	9,00,000

No. of units of A =  $9,00,000 / 45 = 20,000$  units

**Problem 36**

A review, made by the top management of Sweet and Struggle Ltd. which makes only one product, of the result of two first quarters of the year revealed the following:

Sales in units	10,000
Loss (₹)	₹ 10,000
Fixed Cost (for the year ₹1,20,000)	30,000 Quarter
Variable cost per unit	₹ 8

The finance Manager who feels perturbed suggests that the company should at least break-even in the second quarter with a drive for increased sales. Towards this the company should introduce a better packing which will increase the cost by ₹ 0.50 per unit.

The Sales Manager has an alternate proposal. For the second quarter additional sales promotion expenses can be increased to the extent of ₹ 5,000 and a profit of ₹5,000 can be aimed at for the period with increased sales.

The production manager feels otherwise. To improve the; demand the selling price per unit has to be reduced by 3%. As a result the sales volume can be increased to attain a profit level of ₹4,000 for the quarter.

The Managing Director asks for as a Cost Accountant to evaluate these three proposals and calculate the additional units required to reach their respective targets help him to make a decision.

**Answer:****Computation of selling price**

Particulars	₹
Variable cost (10,000 x 8)	80,000
Fixed cost	30,000
Total cost	1,10,000
(+) Profit / (loss)	(10,000)
Sales	1,00,000

Selling price =  $1,00,000 / 10,000 = ₹10/-$

**Statement showing computation of additional units required to attain the target of respective managers**

Sl. No.	Particulars	FM	SM	PM
I	Selling price	10.00	10.00	9.70
II	Variable cost	8.50	8.00	8.00
III	Contribution	1.50	2.00	1.70
IV	Fixed cost	30,000	35,000	30,000
V	Target	BE sales	Profit of ₹ 5,000	Profit of ₹ 4,000
VI	No. of units	$(30,000/1.5) = 20,000$	$(35,000+5,000)/2 = 20,000$	$(30,000+4,000)/1.70 = 20,000$
VII	Additional Units	10,000	10,000	10,000

**Problem 37**

A limited company manufactures three different products and the following information has been collected from the books of accounts.

	PRODUCTS		
	S	T	Y
Sales Mix	35%	35%	30%
Selling price (₹)	30	40%	20
Variable Cost (₹)	15	20%	12
Total fixed cost (₹)	1,80,000		
Total Sales (₹)	6,00,000		

The company has currently under discussion, a proposal to discontinue the manufacture of product Y and replace it with product M, when the following results are anticipated.

	PRODUCTS		
	S	T	M
Sales Mix	50%	25%	25%
Selling price (₹)	30	40%	30
Variable Cost (₹)	15	20%	15
Total fixed cost (₹)	1,80,000		
Total Sales (₹)	6,40,000		

Will you advise the company to changeover to production of M? Give reasons for your answer.

**Answer:****Statement showing computation of profit before replacing product Y with M**

Sl. No.	Particulars	S (35%)	T (35%)	Y (30%)	Total
I	Sales (₹)	2,10,000	2,10,000	1,80,000	6,00,000
II	Variable cost (₹)	1,05,000	1,05,000	1,08,000	3,18,000
III	Contribution (₹)	1,05,000	1,05,000	72,000	2,82,000
IV	Fixed cost (₹)				1,80,000
V	Profit (₹)				1,02,000

**Statement showing computation of profit after replacing product Y with M**

Sl. No.	Particulars	S (50%)	T (25%)	M (25%)	Total
I	Sales (₹)	3,20,000	1,60,000	1,60,000	6,40,000
II	Variable cost (₹)	1,60,000	80,000	80,000	3,20,000
III	Contribution (₹)	1,60,000	80,000	80,000	3,20,000
IV	Fixed cost (₹)				1,80,000
V	Profit (₹)				1,40,000

As the profit is increased by ₹ 38,000 by replacing Product 'Y' with 'M', it is advisable to changeover to the production of M.

**Problem 38**

The following figures have been extracted from the accounts of manufacturing undertaking, which produces a single product for the previous (base) year.

Units produced and sold 10,000

Fixed overhead (₹) 20,000

**Variable overhead cost per unit:**

Labour	₹ 4
Material	₹ 2
Overheads	₹ 0.8
Selling Price	₹10 per unit

In preparing the budget for the current (budget) year the undernoted changes have been envisaged:

Units to be produced and sold	15,000
Fixed overheads increased by	₹ 5,000
Fall in labour efficiency	20%
Special additional discount for Bulk purchased of material	2½ %
Variable overheads percentage reduced by	1¼ %
Fall in selling price per unit	10%

**Calculate:**

- the no. of units which must be sold to break even in each of the two years
- the no. of units which would have to be sold to double the profit of the base year under base year conditions
- the no. of units which will have to be sold in the budget year to maintain the profit level of preceding year.

**Answer:****(i) Statement showing computation of break even units in two years and other required information**

(Amount in ₹)

		Base/Previous Year	Current/Budget Year
I	Selling price	10.00	9.00
II	Variable cost		
	Material	2.00	(2×97.5 / 100) 1.95
	Labour	4.00	(4 / 0.8) 5.00
	Variable Overhead	0.80	(0.8 × 98.75%) 0.79
		6.80	7.74
III	Contribution	3.20	1.26
IV	Total contribution	(10,000 × 3.2) 32,000	(15,000 × 1.26) 18,900
V	Fixed cost	20,000	25,000
	Profit	12,000	(6,100)
	Break Even units	(20,000/3.2) = 6,250 units	(25,000/1.26) = 19,841 units

(ii) No. of units required to double the profit of base year under base year conditions =  $20,000 + 24,000 / 3.2 = 13,750$  units

(iii) No. of units required in current year to get base year Profit =  $(25,000 + 12,000) / 1.26 = 29,365$  units

**Problem 39**

VINAK Ltd. operating at 75% level of activity produces and sells two products A and B. The cost sheets of these two products are as under:-

	Product A	Product B
Units produced and sold	600	400
Direct materials (₹)	2.00	4.00
Direct labour (₹)	4.00	4.00
Factory overheads (40% fixed) (₹)	5.00	3.00
Selling and administration overheads (60% fixed) (₹)	8.00	5.00
Total cost (₹)	19.00	16.00
Selling price per unit (₹)	23.00	19.00

Factory overheads are absorbed on the basis of machine hour which is the limiting factor. The machine hour rate is ₹2 per hour. The company receives an offer from Canada for the purchase of Product A at a price of ₹17.50 per unit.

Alternatively the company has another offer from the Middle East for the purchase of Product B at a price of ₹15.50 p.u.

In both cases, a special packing charge of fifty paise per unit has to be borne by the company.

The company can accept either of the two export orders and in the either case the company can supply such quantities as may be possible to produce by utilising the balance of 25% of its capacity.



You are required to prepare:

- (1) A statement showing the economics of the two export proposals giving your recommendation as to which the proposal should be accepted, and
- (2) A statement showing the overall profitability of the company after incorporating the export proposal recommended by you.

**Answer:**

**(1) Statement showing economics of two products**

(Amount in ₹)

Sr. No.	Particulars	A	B
I	Selling price	17.5	15.5
II	Variable cost		
	Direct Materials	2.00	4.00
	Direct Labour	4.00	4.00
	Factory OH	3.00	1.80
	Selling & Distribution OH	3.20	2.00
	Packing cost	0.50	0.50
		12.70	12.30
III	Contribution	4.80	3.20
IV	Contribution per hour	$(4.8/2.5) = 1.92$	$(3.2/1.5) = 2.13$

The order from middle east for product B is to be accepted because it has more contribution per machine hour.

Machine hours at present capacity (75%) =  $(600 \times 2.5) + (400 \times 1.5)$  = 2,100 hrs

Machine hours at 100% capacity =  $2,100 \times 100/75$  = 2,800 hrs

Hours of balance capacity (25%) =  $2,800 - 2,100$  = 700 hours

No. of units of B that can be manufactured in those 700 hrs =  $700/1.5$  = 467 units.

**(2) Statement showing computation of profit after incorporating the export order**

		A	Home	Export	B	Total
I	No. of units	600	400	467	867	
II	Contribution per unit (₹)	$23-12.2=10.80$	$19-11.8=7.2$	$=3.2$		
III	Total contribution (₹)	6,480	2,880	1,494.4	4,374.4	10,854.4
IV	Fixed cost (₹)	$(2+4.8) \times 600=4,080$	$4.2 \times 400=1,680$	---	1,680	5,760.0
V	Profit (₹)	2,400	1,200	1,494.4	2,694.4	5,094.4

**Problem 40**

Your company has a production capacity of 2,00,000 units per year. Normal capacity utilisation is reckoned at 90%. Standard Variable Production costs are ₹ 11 p.u. The fixed costs are ₹ 3,60,000 per year. Variable selling costs are ₹ 3 p.u. and fixed selling costs are ₹ 2,70,000 per year. The unit selling price is ₹ 20. In the year just ended on 30th June, 2012, the production was 1,60,000 units and sales were 1,50,000 units. The closing inventory on 30-6-2012 was 20,000 units. The actual variable production costs for the year was ₹ 35,000 higher than the standard.

**Calculate:**

- (1) The profit for the year
  - (a) by absorption costing method
  - (b) by the marginal cost method.
- (2) Explain the difference in profits.

**Answer:****(1) (a) Statement showing computation of profit under absorption costing**

Particulars	Amount (₹)
Standard variable production = 1,60,000 x 11	17,60,000
(+) Variance	35,000
Actual variable production costs	17,95,000
Fixed production cost recovered (1,60,000 x ₹ 2*)	3,20,000
	21,15,000
(+) Under recovery of fixed production overheads (3,60,000 – 3,20,000)	40,000
Production cost of goods manufactured	21,55,000
(+) Opening Stock (10,000 x 13) *	1,30,000
(-) Closing stock (21,55,000/1,60,000 x 20,000)	2,69,375
(+) Selling expenses	
Variable 1,50,000 x 3 = 4,50,000	
Fixed = 2,70,000	7,20,000
	27,35,625
Profit	2,64,375
Sales (1,50,000 x 20)	30,00,000

Variable cost = 11.00

(+) Fixed production cost per unit

(3,60,000/2,00,000 x 90%) = \*2.00

= 13.00

**(b) Statement showing computation of profit under marginal costing**

	Particulars	₹	₹
I	Sales		30,00,000
II	Variable cost		
	Production (17,60,000 + 35,000)	17,95,000	
	(+) Opening (10,000 x 11)	1,10,000	
		19,05,000	
	(-) Closing stock (17,95,000/1,60,000 x 20,000)	2,24,375	16,80,625
	Selling expenses (1,50,000 x 3)		4,50,000
			21,30,625
III	Contribution (I-II)		8,69,375
IV	Fixed cost (3,60,000 + 2,70,000)		6,30,000
V	Profit (III-IV)		2,39,375



- (2) The difference in profit shown by absorption costing and marginal costing is due to valuation of costs i.e., stocks are valued at total production cost in absorption costing and at variable production cost in marginal costing.

The difference in profits can be explained as follows:

	Absorption Costing	Marginal Costing	Profit is (less)/more in absorption costing
Opening stock	1,30,000	1,10,000	(-) 20,000
Closing stock	2,69,375	2,24,375	(+) 45,000

#### Problem 41

From the following data calculate:

- (1) B.E.P expressed in amount of sales in rupees.
- (2) Number of units that must be sold to earn a profit of ₹60,000 per year
- (3) How many units must be sold to earn a net income of 10% of sales.

Sales price ₹ 20 per unit; variable manufacturing costs ₹ 11 p.u.; fixed factory overheads ₹ 5,40,000 p.a.; variable selling costs ₹ 3 p.u. Fixed selling costs ₹ 2,52,000 per year.

#### Answer:

	Particulars	(₹)
I	Selling price	20.00
II	Variable cost (11+3)	14.00
III	Contribution per unit (i - ii)	6.00

$$\text{BEP in units} = (2,52,000 + 5,40,000) / 6 = 1,32,000$$

$$\text{a) BEP sales} = 1,32,000 \times 20 = 26,40,000$$

$$\text{b) No. of units} = (7,92,000 + 60,000) / 6 = 1,42,000$$

c) Let 'S' be the no. of units required

$$\text{Sales} = S \times 20 = 20S$$

$$\text{Desired profit} = 20S \times 10\% = 2S$$

$$\text{Required units} = \frac{\text{F. C} + \text{Desired Profit}}{\text{Contribution per unit}}$$

$$S = (7,92,000 + 2S) / 6$$

$$4S = 7,92,000$$

$$S = 1,98,000$$

**Problem 42**

The Board of Directors of KE Ltd. manufacturers of three products A, B and C have asked for advice on the production mixture of the company.

- (a) You are required to present a statement to advice the directors of the most profitable mixture of the products to be made and sold.

The statement should show:

- (i) The profit expected on the current budgeted production, and
- (ii) The profit which could be expected if the most profitable mixture was produced.

- (b) You are also required to direct the director's attention to any problem which is likely to arise if the mixture in (a) (ii) above were to be produced.

The following information is given:-

Data for standard Costs, per unit:

	Product A	Product B	Product C
Direct material (₹)	10	30	20
Variable overhead (₹)	3	2	5

Direct Labour:

Department	Rate per hour	Hours	Hours	Hours
1	0.5	28	16	30
2	1.0	5	6	10
3	0.5	16	8	30

Data from current budget production

in thousands of units per year:	10	5	6
Selling price per unit: (₹)	50	68	90

Fixed cost per year ₹ 2,00,000

Maximum sales forecast by the Sales director for the year 2013 in thousands of units	12	7	9
--	----	---	---

However the type of labour required by Dept 2 is in short supply and it is not possible to increase the manpower of this dept. beyond its present level.



**Answer:**

**(a) Statement showing computation of contribution per hour in Dept. 2 and determination of priority for profitability**

Sr. No.	Particulars	A (₹)	B (₹)	C (₹)
I	Selling price	50	68	90
II	Variable cost			
	Direct Material	10	30	20
	Variable OH	3	2	5
	Direct labour in			
	Dept 1	14	8	15
	Dept 2	5	6	10
	Dept 3	8	4	15
III	Total Variable Cost	40	50	65
IV	Contribution (i - iii)	10	18	25
V	Contribution per hour in Dept. 2	10/5 = 2	18/6 = 3	25/10 = 2.5
	Priority	III	I	II

**Statement showing computation of profit at current budgeted production**

Sr. No.	Particulars	A (₹)	B (₹)	C (₹)	Total
I	No. of units	10,000	5,000	6,000	
II	Contribution per unit (₹)	10	18	25	
III	Total contribution (₹)	1,00,000	90,000	1,50,000	3,40,000
IV	Fixed cost (₹)				2,00,000
V	Profit (₹)				1,40,000

No. of hours in Dept. 2 = (10,000 x 5) + (5,000 x 6) + (6,000 x 10) = 1,40,000 hours

**Statement showing optimum mix under given conditions and computation of profit at that mix**

Sr. No.	Particulars	A (₹)	B (₹)	C (₹)	Total
I	No. of units	1,600	7,000	9,000	
II	Contribution per unit (₹)	10	18	25	
III	Total contribution (₹)	16,000	1,26,000	2,25,000	3,67,000
IV	Fixed cost (₹)				2,00,000
V	Profit (₹)				1,67,000

Available hours	= 1,40,000
(-) hours used for B (7,000 x 6)	= 42,000
	= 98,000
(-) hours for C (9,000 x 10)	= 90,000
	= 8,000
Units of A = 8,000/5	= 1,600 units



- (b) The directors are to pay attention on the point that the sales of less no. of units of 'A' will adversely affect the sales of product 'B' and 'C' (or) not.

**Problem 43**

An engineering company receives in enquiry for the manufacture of certain products, where costs estimated as follows per product. Direct materials ₹ 3.10; Direct labour (5 hours) ₹ 2.05; Direct expenses ₹ 0.05 Variable overheads 20 paise per hour.

The manufacture of these products will necessitate the provision of special tooling costing approximately ₹ 4,500. The price per unit is ₹ 8.00. For an order to be considered profitable it is necessary for it to yield a target contribution at the rate of ₹ 0.30 per Labour Hour (after tooling cost).

Find out:

- (a) The sales level at which contribution to profit commences.  
(b) The sales at which the contribution exceeds the target.

**Answer:**

**Statement Showing Computation of Contribution**

Sr. No.	Particulars	Amount (₹)
I	Selling Price	8.00
II	Variable Cost	
	Direct material	3.10
	Direct Labour	2.05
	Direct expenses	0.05
	Variable OH (5 × 0.2)	1.00
III	Total Variable Cost	6.20
	Contribution (i – iii)	1.80

Break even units =  $4,500 / 1.8 = 2,500$  units.

Break even sales =  $2,500 \times 8 = ₹ 20,000$

Target profit = ₹ 0.3 per hour i.e. ₹ 1.5 per unit ( $5 \times 0.3$ )

Let 'S' be the required units.

Desired profit =  $1.5 \times S = 1.5S$

Required units =  $4,500 + 1.5S / 1.8$

$\Rightarrow S = 4,500 + 1.5S / 1.8$

$\Rightarrow S = 15,000$  units

Required sales =  $15,000 \times 8 = ₹ 1,20,000$ .

**Problem 44**

The present output details of a manufacturing department are as follows:

Average output per week - 48,000 units from 160 employees.

	(₹)
Saleable value of the output	1,50,000
Contribution made by output towards fixed expenses and profit	60,000

The board of directors plan to introduce more mechanisation into the department at a capital cost of ₹ 40,000. The effect of this will be to reduce the number of employees to 120, but to increase the output per individual employees by 40%. To provide the necessary incentive to achieve the increased output, the board intends to offer a 1% increase on the piece of work price of 25 paise per article for every 2% increase in average individual output achieved. To sell the increased output, it will be necessary to decrease the selling price by 4%. Calculate the extra weekly contribution resulting from the proposed change and evaluate for the board's consideration, the worth of the project.

**Answer:**

**Statement Showing the Computation of Selling Price Per Unit**

Sr. No.	Particulars	Amount (₹)
I	Sales	1,50,000
II	Contribution	60,000
III	Variable cost	90,000
IV	Direct Labour (48,000 x 0.25)	12,000
V	Variable cost other than labour	78,000
VI	Variable cost other than labour per unit (78,000/48,000)	1.625
VII	Output per employee (48,000/160) (units)	300
VIII	Selling price (1,50,000 / 48,000)	3.125

**Statement showing computation of contribution after introduction of mechanization**

Sr. No.	Particulars	Amount (₹)
I	No. of employees	120
II	Output per employee (300 x 140/100)	420
III	Total output	50,400
IV	Selling Price (3.125 x 96/100)	3
V	Sales	1,51,200
VI	Variable cost	
	V.C other than labour (50,400 x 1.625)	
	Labour cost (50,400 x 0.25 x 120/100)	97,020
VII	Contribution	54,180

From the above computation, it was found that there is no extra contribution due to increase of mechanization and in fact contribution decreased by ₹ 5,820. There is no worth of project.



## GLOSSARY

**Angle of Incidence:** Angle of Incidence is the angle between sales and total cost line. This angle is an indicator of profit earning capacity of the firm over the break-even point sales.

**Break-even Analysis:** Break-even Analysis is a method for examining the relationship between sales revenue, variable costs and fixed costs to determine the minimum value of production necessary to break-even.

**Break-even Chart:** Break-even Chart is the chart which shows the profitability or otherwise of a firm at various levels of activity. It indicates the point at which neither profit nor loss is made.

**Break-even Point:** Break-even Point is the volume of production or sales where total costs are equal to total revenue. In other words, Break-even Point is the level of activity at which there is neither profit nor loss.

**Cash Break-even Point:** When break-even point is calculated only with those fixed costs which are payable in cash, such a break-even point is known as Cash Break-even Point.

**Contribution or Gross Margin:** Contribution or Gross Margin is the difference between sales value and the variable cost. In other words, Contribution or Gross Margin is defined as the amount recovered towards fixed cost and profit.

**Cost-Volume-Profit (CVP) Analysis:** Cost-Volume-Profit (CVP) Analysis is a technique for evaluating the relationship between costs, volume and profit.

**Differential Cost:** Differential Cost is the change in the costs which results from the adoption of an alternative course of action.

**Marginal Cost:** Marginal Cost is the amount at any given volume of output by which aggregate costs are changed if the volume of output is increased or decreased by one unit. Marginal cost includes prime cost plus variable overhead.

**Marginal Costing:** Marginal Costing is the ascertainment of marginal costs and of the effect on profit of changes in volume or type of output by differentiating between fixed costs and variable costs. In other words, Marginal Costing is a costing system in which variable costs are charged to cost units and fixed costs of the period are written off in full against the total contribution.

**Margin of Safety:** Margin of Safety is represented by excess sales over and above the break-even point sales.

**Profit Volume Chart:** Profit volume chart is the chart that shows the relationship between profit and sales volume.

**Profit Volume Ratio (P/V Ratio) or Contribution Ratio:** Profit Volume Ratio (P/V Ratio) or Contribution Ratio is the ratio of Contribution to Sales.

$P/V \text{ Ratio} = (\text{Contribution}/\text{Sales}) \times 100$  or

$= [(\text{Sales} - \text{Variable cost})/\text{Sales}] \times 100$  or

$= (\text{Change in Contribution}/\text{Change in Sales}) \times 100$  or

$= (\text{Change in Profit}/\text{Change in Sales}) \times 100$

**Self Learning Questions:**

1. Distinguish between Marginal Costing and Absorption costing.
2. State the utility of marginal costing in price fixation during trade depression and for export purposes.
3. Define marginal costing and state the features of marginal costing
4. State the benefits accrue out of application of Marginal Costing
5. Discuss the Limitations of Marginal Costing.
6. What do you mean by Transfer pricing. State the objects in brief.
7. Explain the various methods of Transfer pricing
8. State the objective of Inter Company Transfer Pricing
9. What do you mean by Differential Cost Analysis. State its silent features.
10. Write short notes on:
  - (a) Key factor
  - (b) Breakeven Point
  - (c) Margin of Safety
  - (d) Angle of Incidence
  - (e) Profit Volume chart

**Multiple Choice Questions:**

1. The breakeven point is the point at which,
  - A. There is no profit, no loss
  - B. Contribution margin is equal to total fixed cost
  - C. Total fixed cost is equal to total revenue
  - D. All of the above.
2. A large margin of safety indicates
  - A. Over capitalization
  - B. The soundness of business
  - C. Overproduction
  - D. None of the above
3. The selling price is ₹ 20 per unit, variable cost ₹12 per unit, and fixed cost ₹16,000, the breakeven-point in units will be
  - A. 800 units
  - B. 2000 units
  - C. 3000 units
  - D. None of these



4. The P/V ratio of a product is 0.4 and the selling price is ₹40 per unit. The marginal cost of the product would be,
  - A. ₹ 8
  - B. ₹ 24
  - C. ₹ 20
  - D. ₹ 25
5. Fixed cost per unit decreases when,
  - A. Production volume increases
  - B. Production volume decreases
  - C. Variable cost per unit decreases
  - D. Variable cost per unit increases.
6. Each of the following would affect the breakeven point except a change in the,
  - A. Number of units sold.
  - B. Variable cost per unit
  - C. Total fixed cost
  - D. Sales price per unit.
7. A decrease in sales price,
  - A. Does not affect the break-even-sales.
  - B. Lowers the net profit
  - C. Increases the break-even-point.
  - D. Lowers the break-even-point
8. Under the marginal costing system, the contribution margin discloses the excess of,
  - A. Revenue over fixed cost
  - B. Projected revenue over the break-even-point
  - C. Revenues over variable costs
  - D. Variable costs over fixed costs.
9. Cost volume-profit analysis allows management to determine the relative profitability of product by,
  - A. Highlighting potential bottlenecks in the production process
  - B. Keeping fixed costs to an obsolete minimum
  - C. Determine contribution margin per unit and projected profits at various levels production
  - D. Assigning costs to a product in a manner that maximizes the contribution margin.
10. Contribution margin is known as,
  - A. Marginal income
  - B. Gross profit
  - C. Net income
  - D. Net profit.

**Match the following:**

Column A		Column B	
1	Differential cost is adopted.	A	Contribution / Sales X 100
2	Contribution	B	Decision Making
3	P/V ratio	C	Profit/ Pv ratio
4	Differential costing	D	Differential Cost
5	Shut down point	E	To ascertain Pv ratio.
6	Marginal costing helps in the measuring of.	F	Fixed cost / Pv ratio
7	Margin of Safety	G	Fixed per unit
8	Difference between the costs of two alternatives is known as.	H	Divisional performance
9	Variable cost remain	I	Marginal Costing
10	Breakeven point	J	Avoidable fixed cost / Pv ratio

[Ans: 1-I, 2-E, 3-A, 4-B, 5-J, 6-H, 7-C, 8-D, 9-G, 10-F]

**State the following statement is true or false:**

1. Marginal cost includes prime cost plus fixed overheads.
2. Contribution is the difference between the selling price and the variable costs.
3. An increase in the volume of the production will result in reduction in unit variable cost.
4. The amount of profit under absorption costing and marginal costing is one and the same.
5. All variable costs are included in the marginal cost.
6. Margin of safety is the difference between actual sales and the sales and the break even point.
7. The difference between the budgeted output and the actual output is known as margin of safety.
8. The breakeven point will be lower if the selling price is increased but the amount of cost does not change.
9. At breakeven point margin of safety is nil.
10. When fixed cost is deducted from total cost, we get marginal cost.

[Ans: 1-False; 2-True; 3-False; 4-False; 5-True; 6-True; 7-False; 8-False; 9-True; 10-True]

**Fill in the blanks:**

1. In cost accounting, marginal cost does not include \_\_\_\_\_ .
2. In absorption costing, \_\_\_\_\_ cost is added to inventory.
3. Sales minus variable cost = fixed costs plus \_\_\_\_\_ .
4. Profit volume ratio is contribution / \_\_\_\_\_ × 100



5. At breakeven point total revenue is equal to \_\_\_\_\_ costs.
6. In marginal costing, fixed costs are charged to \_\_\_\_\_.
7. Margin of safety is the difference between \_\_\_\_\_ and \_\_\_\_\_ .
8. In marginal costing, stock is valued at \_\_\_\_\_.
9. When the production volume is nil, the loss will be equal to\_\_\_\_\_.
10. Constraint on various resources is also known as \_\_\_\_\_ .

[Ans: 1.-Fixed Cost; 2.-Fixed; 3.-Profit; 4.-Sales; 5.-Fixed; 6.-Costing Profit and loss account; 7.-Total Sales– BEP Sales; 8.-Variable cost; 9.-Fixed cost; 10.-Key factor or Limiting factor]





# Study Note - 3

## BUDGETING AND BUDGETARY CONTROL



### This Study Note includes

- 3.1 Budgetary Control and Preparation of Functional and Master Budgeting
- 3.2 Fixed, Variable, Semi-Variable Budgets
- 3.3 Zero Based Budgeting (ZBB)

### 3.1 BUDGETARY CONTROL AND PREPARATION OF FUNCTIONAL AND MASTER BUDGETING

#### Budget

The Terminology (CIMA – London) defines a budget as "a plan quantified in monetary terms, prepared and approved prior to a defined period of time, usually showing planned income to be generated and/or expenditure to be incurred during that period and the capital to be employed to attain a given objective".

#### Budgetary Control

Budgetary control is defined as "the establishment of budgets relating the responsibilities of executives to the requirements of a policy and the continuous comparison of actual with budgeted results, either to secure by individual action the objective of that policy or to provide a basis for its revision."

From the above definition, the steps for Budgetary Control can be drawn as follows: -

#### (i) Establishment of Budgets

Budgetary control primarily aims at preparation of various budgets such as sales Budget, production budget, overhead expenses budget, cash budget etc.,

#### (ii) Responsibilities of executives

The budgetary control system is designed to fix responsibilities on executives through preparation of budgets.

#### (iii) Policy making

The established policies of the organisation are designed as budgets so as to fix responsibility on executives.

#### (iv) Comparison of actuals with budgets

After establishing the budgets, the actuals are compared with them and any deviations, if any are called variances.

#### (v) Achieving the desired result

The desired result of the budgetary control system is comparison of actuals with the budgeted results and the causes of variances, if any, are analysed.

#### (vi) Reporting to Top Management

After the causes of Variances are analysed, the variances and their causes are reported to top management so that the remedial action can be taken.



### **Advantages of Budgetary Control**

- (i) Budgetary control aims at *maximisation of profits* through optimum utilisation of resources.
- (ii) It is a technique for *continuous monitoring of policies and objectives* of the organisation.
- (iii) It helps in *reducing the costs, thereby helps in better utilisation of funds* of the organisation.
- (iv) All the departments of the organisation are closely coordinated through *establishment of plans resulting in smooth functioning* of the organisation.
- (v) Since budgets fix the responsibilities of the executives, they act as a *plan of action* for them there by reducing some of their work.
- (vi) It facilitates analysis of variances, thereby *identifying the areas where deficiencies occur and proper remedial action* can be taken.
- (vii) It facilitates the *management by exception*.
- (viii) Budgets act as a motivating force to *achieve the desired objective* of the organisation.
- (ix) It assists delegation of authority and is a *powerful tool of responsibility accounting*.
- (x) It helps in *stabilizing the conditions in industries* which face seasonal fluctuations.
- (xi) It helps as a *basis for internal audit*.
- (xii) It provides a suitable basis for introducing the *payment by results system*.
- (xiii) It ensures *adequacy of working capital* to the organisation.
- (xiv) It aids in *performance analysis and performance reporting system*.
- (xv) It aids in obtaining *bank credit*.
- (xvi) Budgets are forerunners of standard costs in the sense that they *create necessary conditions to suit setting up of standard costs*.

### **Limitations of Budgetary Control**

As we have observed that budgetary control is a system where from a number of advantages flow in provided it is applied in an appropriate manner. On the contrary, if the system is interpreted in a wrong way, misused, or approached with negative attitude certain ill-effects may be the outcome for which the budgetary control system should not be blamed. Some negative outcomes are mentioned hereunder:

1. Budget may be taken as a rigid plan for future for which the firm may lose its flexibilities to meet the contingencies in future.
2. Budget, being an estimate there remain scope for bias.
3. Lazy participants often set budget as a standard at the low level. This practice, however, allows for inefficiency.
4. It allows more authority to previous plan than to the present need.
5. Workers and management are often unwilling to exceed budgeted level of performance in apprehension that instead of rewarding their efficiency in the long-term the budget may be revised to set new standard.



### Prerequisites for the Adoption of Budgetary Control System

For the successful implementation of a system of budgetary control certain *pre-requisites* are to be fulfilled. These are enumerated below:

- (i) There should be an *organization chart* laying out in clear terms the responsibilities and duties of each level of executives, and the delegation of authority to the various levels. For complete success, a solid foundation in this regard should be laid at the outset.
- (ii) The *objectives, plans and policies of the business should be defined* in clear cut and unambiguous terms.
- (iii) The *output level* for which budgets are fixed, i.e., the budgeted output, should be stated.
- (iv) The *principal budget factor* which will be the starting point of the preparation of the various budgets should be indicated.
- (v) There should be an *efficient system of accounting* to record and provide data in line with the budgetary control system.
- (vi) For the establishment and efficient execution of the plan, a *Budget Committee* should be set up.
- (vii) There should be a *proper system of communication and reporting* between the various levels of management.
- (viii) There should be a charter of programme. This is usually in the form of a *budget manual*.
- (ix) The budgets should primarily be prepared by those who are *responsible for performance*.
- (x) The budgets should be *complete, continuous and realistic*.
- (xi) There should be an assurance from the top management executives of *co-operation and acceptance* of the budgetary system.

### Functional Budget

Functional Budget is a budget of income and/or expenditure applicable to a particular function or department.

If budgets are prepared of a business concern for a certain period taking each and every function separately such budgets are called functional budgets.

Example: Production, Sales, purchases, cost of production, cash, materials etc.

The following are the various functional budgets, some of which are briefly explained here under:

**(i) Sales Budget:** Sales Budget is the quantitative and financial statement of sales, prepared prior to a defined period of time, to be achieved during that period.

The sales budget is a forecast of total sales, expressed in terms of money or quantity or both. The first step in the preparation of the sales budget is to forecast as accurately as possible, the sales anticipated during the budget period. Sales forecasts are usually prepared by the sales manager assisted by the market research personnel.

### Factors to be considered in preparing Sales Budget

As business existence depends upon the sales it is going to make and therefore it is an important one to be prepared meticulously. It is the forecast of what it can reasonably sell to its customers during the period for which budget is prepared. The company's profit mostly depends upon the ability to sell its products to customers. In the present era it is indispensable to establish the demand for the product even before it is produced. It is the sales order book that the company's continuity depends upon. Also, a reasonable degree of accuracy must be there in preparing a sales budget unless its sales are accurately forecast, production estimates will also become erroneous. A good amount of experience must be necessary to prepare the sales budget.



The following factors must be considered in preparing the sales budget:

- (a) The locality of the market i.e., domestic or export
- (b) The target customers i.e., industry or trade or a section or group of general public etc.,
- (c) The product portfolio i.e., the number of products offered and their popularity among the target customers.
- (d) The market share of each product and its influence on the product portfolio and the total market
- (e) The effectiveness of existing marketing policy on the current sales volume and value.
- (f) The market share of competitor's products and their effect on the company's sales.
- (g) Seasonal fluctuation in sales.
- (h) Expenditure on advertisement and its impact on sales.

**(ii) Production Budget:** Production Budget is a forecast of the production for the budget period of an organisation. Production budget is prepared in two parts, viz. production volume budget for the physical units of the products to be manufactured and the cost of production or manufacturing budget detailing the budgeted cost under material, labour, and factory overhead in respect of the products.

#### **Factors to be considered in Production Budget**

Next to the sales budget, the main function of a business concern is the production and for this, a budget is prepared simultaneously with the sales budget. It is the forecast of production during the period for which the budget is prepared. It can also be prepared in two parts viz., production volume budget for the physical units i.e., the number of units, the tonnes of production etc., and the cost of production or manufacture showing details of all elements of the manufacture. While preparing the production budget, the following factors must be taken into consideration:-

#### **(a) Production plan**

Production planning is an important part of the preparation of the production budget. Optimum utilisation of plant capacity is taken by eliminating or reducing the limiting factors and thereby effective production planning is made.

#### **(b) The capacity of the business concern**

It is to be ensured that the capacity of the organisation will coincide the budgeted production or not. For this purpose, plant utilisation budget will also be necessary. The production budget must be based on normal capacity likely to be achieved and it should not be too high or too low.

#### **(c) Inventory Policy**

While preparing the production budget it is also necessary to see to what extent materials are available for producing the budgeted production. For that purpose, a purchase budget or a purchase plan must also be studied. Similarly, on the other hand, it is also necessary to verify the extent to which the inventory of finished goods is to be carried.

#### **(d) Sales Policy**

Sales budgets must also be considered before preparing production budget because it may so happen that the entire production of the concern may not be sold. In such a case the production budget must be in line with the sales budget.

#### **(e) Sequence of Operations Policy**

A plan of the sequence of operations of production for effective preparation of a production budget should always be there.



### (f) Management Policy

Last, but not the least, the policy of the management should also be considered before preparing the production budget.

### Objectives and Advantages of Production budget

- Optimum utilisation of the productive resources of the organisation;
- Maintaining low inventory which results in risk of deterioration and fall in prices;
- Focus on the factors that are necessary to frame policies and plan sequence of operations;
- Projection of policies framed, on the basis of past performance, into the future to get the desired results;
- To see that right materials are provided at right place and at right time;
- Helps in scheduling of production so that delivery dates are met and customer satisfaction is gained;
- Helpful in preparation of projected profit and loss statement, which is useful in evaluation of performance and profitability.

**(iii) Materials Budget:** Materials Budget is the budget that includes quantities of direct materials needed for the finished product in the budget period of an organisation. The material budget includes quantities of direct materials; the quantities of each raw material needed for each finished product in the budget period is specified. The input data for this budget is obtained by applying standard material usage rates by each type of material to the volume of output budgeted.

**(iv) Purchase Budget:** Purchase Budget is the budget that establishes the quantity and value of the various items of materials to be purchased for delivery at specified point of time during the budget period taking into account the production schedule and the inventory requirements of the organisation. It takes into account the requirements for the entire budget plan as per the sales, materials, maintenance, research and development, and capital budgets. Purchases may be required to be made in respect of direct and indirect materials, finished goods for resale, components and parts, and purchased services. Before incorporation in the purchase budget, these purchase requirements should be suitably ascertained. Purchase budget also includes material procurement budget.

**(v) Cash Budget:** The terminology defines cash budget 'as a detailed budget of cash income and cash expenses incorporating both revenue and capital items'. This budget is prepared after all functional budgets are prepared. It extends over the budget period. However, for control purposes, it is necessary to analyse cash budget to show monthly or weekly requirements of cash.

Reviewing the budgeted liquidities position, different financial plans and policies are chalked out and their impact on liquidities are also incorporated within the cash budget. For example, let us assume that the cash budget reveals a negative cash position in the month of July. The management would immediately plan for filling the financial gap say, through issue of debenture. The cash inflow from such planned issue of debenture also would be incorporated in the cash budget.

### Advantages of cash budget

1. It aids in securing option working capital need for smooth running of the operation and planning for payments to the shareholders
2. It eases strains of a cash shortage
3. It facilitates temporary cash investment wherever, and to whatever extent, found in excess
4. It provides for normal growth



A better planning is necessary to ensure that only an optimum balance of cash/ bank is held and that the surplus cash is invested in more profitable opportunities elsewhere, if investment in the business is not possible or desirable at once. This will help in improving the rate of return of a firm. Such surplus cash is often invested temporarily in short-term securities.

Cash budgeting by months, weeks, or even days will enable a firm to determine with reasonable degree of accuracy, what proportion of cash balance, and for how long, is available for investment outside the business.

When a company needs additional long-term capital, it is usually possible to obtain such capital on favourable terms, if the need is known well in advance. The cash budgeting makes it possible to choose an advantageous time to tap the market for equity capital or long-term debt capital.

### Preparation of Cash Budget

A cash budget can be prepared in three ways. They are:

1. The receipt & Payment Method	→	for detailed short-term cash budget
2. The Adjusted profit & Loss Method	→	For making long-term cash budget
3. The Balance Sheet Method		

### Cash budgeting-short-term and long- term

The principal method of short-term cash forecasting is the Receipt & Payment method. The cash budget prepared under this method shows the timing and magnitude of expected cash receipts and payments over the budget period, not usually exceeding one year.

**(vi) Personnel Budget:** Personnel Budget is a forecast of planned outlay on direct and indirect labour of a company during the budget period. This budget is based on:

1. Production budget
2. Sales budget
3. Capital expenses budget
4. R & D cost budget
5. Possibility of new wage agreements

The main purposes of this budget are:

1. To help in the efficient labour management
2. To show the planned outlay on direct and indirect wages

**(vii) Capital Expenditure Budget:** Capital Expenditure Budget is a plan for capital expenditure in monetary terms. It is the planned outlay on fixed assets during the budget period. This budget is usually prepared for a long period, say 5 or 10 years. For control purpose, it is broken down into short periods. The preparation of this budget is the responsibility of head of Accounts, who will be assisted by the plant manager and other functional heads, on the basis of a number of information, e. g.

1. Plant utilisation budget
2. Long-term business policy
3. Potential demand for certain products

Based on the information, a company may decide for extension of factory capacity, purchase of new and better factory equipments which will entail heavy capital expenditure.



**(viii) Selling and distribution cost budget:** Selling & Distribution Cost Budget is a forecast of the cost of selling & distribution of goods during the budget period. This budget is based on:

1. Sales budget
2. Selling & distribution cost budget for the current period
3. Actual selling & distribution costs for the current period
4. Expected changes in the rate of commission on sales, method of distribution, advertisement policy, etc.

**(ix) Administration Cost Budget:** Administration Cost Budget shows the total estimated of administration, i. e. cost of formulating the policy, directing the organisation and controlling the operations. Most of the expenses relating to administration are of 'fixed' nature within defined limits. So this budget is easy to prepare. Formally, each budget centre or department prepares its own budget which gets incorporated in this budget afterwards.

**ABC Company Ltd.**  
**Administration Cost Budget**  
**For the year ending March 31, 2019**

Particulars	(₹)
Salaries of clerical staff	xxxxx
Executives' salaries	xxxx
Audit fee	xxx
Depreciation on office equipment	xxx
Insurance	xxx
Stationery	xxxx
Postage and telegrams	xxx
Telephones	xxx
Miscellaneous	xxxx
Total administration expenses	xxxxx

**(x) Research and development Cost Budget (R & D Budget):** Research & Development Cost Budget is a planned outlay on R & D activities of a company. The budget covers materials, equipment and supplies, salaries, expenses, and other costs relating to design, development and technical research projects.

**(xi) Master Budget:** Master Budget is defined as a budget which is prepared from the functional budgets in summary form. When all functional budgets are prepared, they are summarised to produce budgeted profit & loss account, and budgeted balance sheet.

Master budget is the budget prepared to cover all the functions of the business organisation. It can be taken as the integrated budget of business concern, that means, it shows the profit or loss and financial position of the business concern such as Budgeted Profit and Loss Account, Budgeted Balance Sheet etc. Master budget, also known as summary budget or finalized profit plan, combines all the budgets for a period into one harmonious unit and thus, it shows the overall budget plan. The master budget incorporates all the subsidiary functional budgets and the budgeted Profit and Loss Account and Balance Sheet. Before the budget plan is put into operation, the master budget is considered by the top management and revised if the position of profit disclosed therein is not found to be satisfactory. After suitable revision is made, the master budget is finally approved and put into action. Another view regards the budgeted Profit and Loss Account and the Balance Sheet as the master budget.



### 3.2 FIXED, VARIABLE, SEMI-VARIABLE BUDGETS

#### Fixed or Rigid Budget

A fixed budget is a budget which is designed to remain unchanged irrespective of the volume of output. When budgets are prepared for a fixed or standard volume of activity, they are called static or rigid or fixed budgets. They do not change with the changes in the volume of the output. These are prepared normally 3 months in advance of the year. However these will not be much helpful in comparing the actual activity, as these are prepared at a fixed volume of output. It, however, does not mean that the fixed budget is a rigid one, not to be changed at all. Though not adjusted to the actual volume attained, a fixed budget is liable to revision if due to business conditions undergoing a basic change or due to other reasons, actual operations differ widely from those planned in the fixed budget.

Fixed budgets are most suited for fixed expenses. In case of discretionary costs situations where the expenditure is optional and has no relation with the output, e.g. expenditure on research and development, advertising, and new projects. A fixed budget has only a limited application and is ineffective as a tool for cost control. Fixed budgets are useful where the plan permits maximum stabilization of production, as for example, for concerns which manufacture to build up inventories of finished products and components.

#### Flexible Budget

A flexible budget is a budget which, by recognising the difference in behaviour between fixed and variable costs in relation to fluctuations in output, turnover, or other variable factors, is designed to change appropriately with such fluctuations.

A flexible budget is a budget that is prepared for different levels of activity or capacity utilization or volume of output. If the budgets are prepared in such a way so as to change in accordance with the volume of output, they are called flexible budgets. These can be prepared from fixed budget which are also called revised budgets. These are much helpful in comparison with actual because the exact deviations are found for which timely corrective action can be taken. The basic idea of a flexible budget is that there shall be some standard of cost and expenditures. Thus, a budget prepared in a manner to give budgeted costs for any level of activity is known as flexible budget. Such budget is prepared after considering the variable and fixed elements of costs and the changes, which may be expected for each item at various levels of operations. Thus a flexible budget recognises the difference in behaviour between fixed and variable costs in relation to fluctuations in production or sales and is designed to change appropriately with such fluctuations. In flexible budget, data relating to costs, expenditures may progressively be changed in any month in accordance with actual output achieved. While preparing flexible budgets, estimates of costs and expenditures on the basis of standards determined are made from minimum to maximum level of operations.

#### Difference between Fixed and Flexible Budgets

	Fixed Budget	Flexible Budget
(i)	It does not change with actual volume of activity achieved. Thus it is known as rigid or inflexible budget.	It can be recasted on the basis of activity level to be achieved. Thus it is not rigid.
(ii)	It operates on one level of activity and under one set of conditions. It assumes that there will be no change in the prevailing conditions, which is unrealistic.	It consists of various budgets for different levels of activity.
(iii)	Here as all costs like – fixed, variable and semi-variable are related to only one level of activity so variance analysis does not give useful information.	Here analysis of variance provides useful information as each cost is analysed according to its behaviour.





(iv)	If the budgeted and actual activity levels differ significantly, then the aspects like cost ascertainment and price fixation do not give a correct picture.	Flexible budgeting at different levels of activity facilitates the ascertainment of cost, fixation of selling price and tendering of quotations.
(v)	Comparison of actual performance with budgeted targets will be meaningless specially when there is a difference between the two activity levels.	It provides a meaningful basis of comparison of the actual performance with the budgeted targets.

### Principal Budget Factor

CIMA-London Terminology defines a key factor or limiting factor or principal budget factor as a factor which at a particular time or over a period will limit the activities of an organisation and which is therefore, taken into account in preparing budgets.

Budgets cover all the functional areas of the organisation. For the effective implementation of the budgetary system, all the functional areas are to be considered which are interlinked. Because of these interlinks, certain factors have the ability to affect all other budgets. Such factor is known as principal budget factor.

Principal Budget factor is the factor the extent of influence of which must first be assessed in order to ensure that the functional budgets are reasonably capable of fulfilment. A principal budget factor may be lack of demand, scarcity of raw material, non-availability of skilled labour, inadequate working capital etc. If for example, the organisation has the capacity to produce 2500 units per annum. But the production department is able to produce only 1800 units due to non-availability of raw materials. In this case, non-availability of raw materials is the principal budget factor (limiting factor). If the sales manager estimates that he can sell only 1500 units due to lack of demand. Then lack of demand is the principal budget factor. This concept is also known as key factor, or governing factor. This factor highlights the constraints with in which the organisation functions.

### Responsibility Accounting

Responsibility Accounting is the system of accounting that segregates revenues and costs into areas of personal responsibility in order to assess the performance attained by persons to whom authority has been assigned.

One of the recent developments in the field of management accounting is the responsibility accounting, which is helpful in exercising cost control. 'Responsibility Accounting is a system of accounting that recognizes various responsibility centers throughout the organization and reflects the plans and actions of each of these centers by assigning particular revenues and costs to the one having the pertinent responsibility. It is also called profitability accounting and activity accounting.

It is a system in which the person holding the supervisory posts as president, function head, foreman, etc are given a report showing the performance of the company or department or section as the case may be. The report will show the data relating to operational results of the area and the items of which he is responsible for control. Responsibility accounting follows the basic principles of any system of cost control like budgetary control and standard costing. It differs only in the sense that it lays emphasis on human beings and fixes responsibilities for individuals. It is based on the belief that control can be exercised by human beings, so responsibilities should be fixed for individuals.

Principles of responsibility accounting are as follows:

- (a) A target is fixed for each department or responsibility center.
- (b) Actual performance is compared with the target.
- (c) The variances from plan are analysed so as to fix the responsibility.
- (d) Corrective action is taken by higher management and is communicated.



### Performance Budgeting

Performance Budgeting means that the responsibility of various levels of management is predetermined in terms of output or result keeping in view the authority vested with them.

Performance Budgeting is synonymous with Responsibility Accounting which means thus the responsibility of various levels of management is predetermined in terms of output or result keeping in view the authority vested with them. The main concepts of such a system are enumerated below:

- (a) It is based on a classification of managerial level for the purpose of establishing a budget for each level. The individual in charge of that level should be made responsible and held accountable for its performance over a given period of time.
- (b) The starting point of the performance budgeting system rests with the organisation chart in which the spheres of jurisdiction have been determined. Authority leads to the responsibility for certain costs and expenses which are forecast or present in the budget with the knowledge of the manager concerned.
- (c) The costs in each individual's or department's budget should be limited to the cost controllable by him.
- (d) The person concerned should have the authority to bear the responsibility.

### 3.3 ZERO BASED BUDGETING (ZBB)

Zero-based Budgeting is defined as a method of budgeting which requires each cost element to be specifically justified, though the activities to which the budget relates are being undertaken for the first time, without approval, the budget allowance is zero.

It differs from the conventional system of budgeting mainly it starts from scratch or zero and not on the basis of trends or historical levels of expenditure. In the customary budgeting system, the last year's figures are accepted as they are, or cut back or increases are granted. Zero based budgeting on the other hand, starts with the premise that the budget for next period is zero so long the demand for a function, process, project or activity is not justified for each rupee from the first rupee spent. The assumptions are that without such a justification no spending will be allowed. The burden of proof thus shifts to each manager to justify why the money should be spent at all and to indicate what would happen if the proposed activity is not carried out and no money is spent.

The first step in the process of zero base budgeting is to develop an operational plan or decision package. A decision package identifies and describes a particular activity with a view to:

- (i) Evaluate and allotted ranking the activity against other activities competing for the same scarce resources, and
- (ii) Decide whether to accept or reject or amend the activity.

For this purpose, each package should give details of costs, returns, purpose, expected results, the alternatives available and a statement of the consequences if the activity is reduced or not performed at all.

The advantages of Zero based budgeting are:

- (a) Out of date and inefficient operations are identified.
- (b) Allows managers to promptly respond to changes in the business environment.
- (c) Instead of accepting the current practice, it creates a challenging and questioning attitude.
- (d) Allocation of resources is made according to needs and the benefits derived.
- (e) It has a psychological impact on all levels of management which makes each manager to 'pay his way'.



### Areas where zero-base budgeting is applicable

Zero-base Budgeting is more suitably applicable to discretionary cost areas. These costs may have no relation to volume or activity and generally arise as a result of management policies. Where standards are determinable, those costs associated with the inputs should be controlled through the use of standard costing. On the other hand, if output as a function of input cannot be specified. Zero-base Budgeting may be more suitably applied. Thus, service or support-type activities are more suitable for Z.B.B.

### PROCESS OF ZERO-BASE BUDGETING OR STEPS INVOLVED IN ZERO-BASE BUDGETING

The process of Zero-Base Budgeting involves the following steps:

1. Identification of 'Decision units'
2. Preparation and development of decision packages.
3. Ranking of priority.
4. Approval and Funding

**Identification of 'Decision units'** - A decision unit refers to a tangible activity or group of activities for which a single manager has the responsibility for successful performance. Thus, decision unit is a programme or a project or a segment of the organisation for which separate budgets are to be prepared.

**Preparation of Decision Packages:** Preparation of decision packages is a set of documents which identify and describe activities of the unit in such a way that the management can evaluate and rank them against others competing for resources (limited) and decide whether to approve or disapprove.

**Ranking of Priority:** The third step involved in Z.B.B. is the ranking of proposed alternatives included in decision packages for various decision units or of various decision packages for the same decision unit.

**Funding:** Funding involves the allocation of available resources of the organisation to various decision units keeping in mind the alternative which has been selected and approved through ranking process.

Zero-based budgeting is better than traditional budgeting due to following reasons:

- I. It gives an opportunity for the management to allocate resources to various activities after a detailed cost benefit analysis.
- II. It helps the management to identify wasteful expenditure and eliminate them.
- III. It also facilitates the management in linking the functional budgets with corporate objectives.
- IV. It facilitates introduction of a system of Management by Objectives (MBO).

### Illustration 1

From the following figures prepare the raw material purchase budget for January, 2015:

	Materials					
	A	B	C	d	e	F
Estimated Stock on Jan 1	16,000	6,000	24,000	2,000	14,000	28,000
Estimated Stock on Jan 31	20,000	8,000	28,000	4,000	16,000	32,000
Estimated Consumption	1,20,000	44,000	1,32,000	36,000	88,000	1,72,000
Standard Price per unit	25 p.	5 p.	15 p.	10 p.	20 p.	30 p.

**Solution:****Raw Materials Purchase Budget For January 2015**

Type	A	B	C	D	E	F	Total
Estimated Consumption (units)	1,20,000	44,000	1,32,000	36,000	88,000	1,72,000	
Add: Estimated stock on Jan 31, 2015 (units)	20,000	8,000	28,000	4,000	16,000	32,000	
	1,40,000	52,000	1,60,000	40,000	1,04,000	2,04,000	
Less: estimated stock on Jan1, 2015 (units)	16,000	6,000	24,000	2,000	14,000	28,000	
Estimated purchase (units)	1,24,000	46,000	1,36,000	38,000	90,000	1,76,000	6,10,000
Rate per unit (₹)	0.25	0.05	0.15	0.10	0.20	0.30	
Estimated purchases (₹)	31,000	2,300	20,400	3,800	18,000	52,800	1,28,300

**Illustration 2**

A company manufactures product - A and product -B during the year ending 31<sup>st</sup> December 2015, it is expected to sell 15,000 kg. of product A and 75,000 kg. of product B at ₹30 and ₹16 per kg. respectively. The direct materials P, Q and R are mixed in the proportion of 3: 5: 2 in the manufacture of product A, Materials Q and R are mixed in the proportion of 1:2 in the manufacture of product B. The actual and budget inventories for the year are given below:

	Opening Stock	Expected Closing stock	Anticipated cost per Kg.
	Kg.	Kg.	₹
Material – P	4,000	3,000	12
Material –Q	3,000	6,000	10
Material – R	30,000	9,000	8
Product - A	3,000	1,500	—
B	4,000	4,500	—

Prepare the Production Budget and Materials Budget showing the expenditure on purchase of materials for the year ending 31-12-2015.

**Solution:****Production Budget for the Products A & B**

Particulars	Product A	Product B
Sales	15,000	75,000
Add: Closing Stock	1,500	4,500
	16,500	79,500
Less: opening Stock	3,000	4,000
Production	13,500	75,500

### Material Purchase Budget for the Year ending Dec 31<sup>st</sup> 2015

Particulars	P	Q	R	Total
Material required for product A in the ratio of 3:5:2	4,050	6,750	2,700	13,500
Material required for product B in the ratio of 1:2	---	25,167	50,333	75,500
Total requirement	4,050	31,917	53,033	
Add: Closing Stock	3,000	6,000	9,000	
	7,050	37,917	62,033	
Less: opening Stock	4,000	3,000	30,000	
Purchases (in units)	3,050	34,917	32,033	
Cost per Kg.	12	10	8	
Total Purchase cost (₹)	36,600	3,49,170	2,56,264	6,42,034

### Illustration 3

The following details apply to an annual budget for a manufacturing company.

Quarter	1st	2nd	3rd	4th
Working days	65	60	55	60
Production (units per working day)	100	110	120	105
Raw material purchases (% by weight of annual total)	30%	50%	20%	—
Budgeted purchase price/Kg.(₹)	1	1.05	1.125	—

Quantity of raw material per unit of production 2 kg. Budgeted closing stock of raw material 2,000 kg. Budgeted opening stock of raw material 4,000 kg. (Cost ₹ 4,000)

Issues are priced on FIFO Basis. Calculate the following budgeted figures.

- Quarterly and annual purchase of raw material by weight and value.
- Closing quarterly stocks by weight and value.

### Solution:

#### Material Purchase Budget

Particulars	Quarter 1	Quarter 2	Quarter 3	Quarter 4	Total
Production	6,500 (65 × 100)	6,600 (60 × 110)	6,600 (120 × 55)	6,300 (60 × 105)	26,000
Material Required (Production × 2)	13,000	13,200	13,200	12,600	52,000
Closing Stock					2,000
					54,000
Less: Opening Stock					4,000
Purchases by Weight	15,000	25,000	10,000	---	50,000

**Computation of Purchases by Value**

Particulars	Quarter 1	Quarter 2	Quarter 3	Quarter 4	Total
Purchases (Weight)	15,000 (50,000 × 30%)	25,000 (50,000 × 50%)	10,000 (50,000 × 20%)	---	
Cost per Kg.	1	1.05	1.125	---	
Purchases (₹)	15,000	26,250	11,250	---	52,500

**Budget Showing Closing Quarterly Stocks by Weight and Value**

Particulars	Quarter 1	Quarter 2	Quarter 3	Quarter 4
opening Stock	4,000	6,000	17,800	14,600
Purchases	15,000	25,000	10,000	-
	19,000	31,000	27,800	14,600
Material consumed	13,000	13,200	13,200	12,600
Closing Stock by Weight	6,000	17,800	14,600	2,000
Closing Stock by Value (₹)	<b>6,000</b> (6,000 × 1)	<b>18,690</b> (17,800 × 1.05)	<b>16,080</b> {(10,000 × 1.125) + (4,600 × 1.05)}	<b>2,250</b> (2,000 × 1.125)

**Illustration 4**

You are required to prepare a Selling overhead Budget from the estimates given below:

Particulars	(₹)
Advertisement	1,000
Salaries of the Sales dept.	1,000
Expenses of the Sales dept. (Fixed)	750
Salesmen's remuneration	3,000

Salesmen's and dearness Allowance - Commission @ 1% on sales affected

Carriage outwards: estimated @ 5% on sales

Agents Commission: 7½% on sales

The sales during the period were estimated as follows:

- ₹80,000 including Agent's Sales ₹8,000
- ₹90,000 including Agent's Sales ₹10,000
- ₹1,00,000 including Agent's Sales ₹10,500

**Solution:****Selling Overhead Budget**

Sales	80,000	90,000	1,00,000
(A) Fixed overhead:			
Advertisement	1,000	1,000	1,000
Salaries of the sales dept.	1,000	1,000	1,000
Expenses of the sales dept.	750	750	750
Salesmen remuneration	3,000	3,000	3,000
Total (A)	5,750	5,750	5,750
(B) Variable overhead:			
Commission	(72,000 x 1%) = 720	(80,000 x 1%) = 800	(89,500 x 1%) = 895
Carriage outwards	4,000	4,500	5,000
Agents Commission	(8,000 x 7.5%) = 600	(10,000 x 7.5%) = 750	(10,500 x 7.5%) = 788
Total (B)	5,320	6,050	6,683
Grand Total (A+B)	11,070	11,800	12,433

**Illustration 5**

ABC Ltd. a newly started company wishes to prepare Cash Budget from January. Prepare a cash budget for the first six months from the following estimated revenue and expenses.

Month	Total Sales (₹)	Materials (₹)	Wages (₹)	Overheads	
				Production (₹)	Selling & Distribution (₹)
January	20,000	20,000	4,000	3,200	800
February	22,000	14,000	4,400	3,300	900
March	28,000	14,000	4,600	3,400	900
April	36,000	22,000	4,600	3,500	1,000
May	30,000	20,000	4,000	3,200	900
June	40,000	25,000	5,000	3,600	1,200

Cash balance on 1st January was ₹10,000. A new machinery is to be installed at ₹20,000 on credit, to be repaid by two equal instalments in March and April, sales commission @5% on total sales is to be paid within a month following actual sales.

₹10,000 being the amount of 2nd call may be received in March. Share premium amounting to ₹2,000 is also obtained with the 2nd call. Period of credit allowed by suppliers — 2months; period of credit allowed to customers — 1month, delay in payment of overheads 1 month. delay in payment of wages ½ month. Assume cash sales to be 50% of total sales.

**Solution:****Cash Budget for the First 6 Months**

Particulars	Jan	Feb	Mar	Apr	May	Jun
opening Balance (A)	10,000	18,000	29,800	27,000	24,700	33,100
Add: Receipts (B)						
Cash Sales (50%)	10,000	11,000	14,000	18,000	15,000	20,000
Collection from debtors	---	10,000	11,000	14,000	18,000	15,000
Share call money (including share premium)	---	---	12,000	---	---	---
Total (A+B)	20,000	39,000	66,800	59,000	57,700	68,100
Less: Payments						
Materials	---	---	20,000	14,000	14,000	22,000
Wages	2,000	4,200	4,500	4,600	4,300	4,500
overheads	---	4,000	4,200	4,300	4,500	4,100
Sales Commission	---	1,000	1,100	1,400	1,800	1,500
Instalment of Machinery purchase	---	---	10,000	10,000	---	---
Total Payments (C)	2,000	9,200	39,800	34,300	24,600	32,100
Closing Balance (A+B-C)	18,000	29,800	27,000	24,700	33,100	36,000

**Note:** According to credit terms wages to be taken at half of the current month plus half of the previous month.

**Illustration 6**

Prepare a Cash Budget for the three months ending 30th June, 2016 from the information given below:

(a)

MONTH	SALES (₹)	MATERIALS (₹)	WAGES (₹)	OVERHEADS (₹)
February	14,000	9,600	3,000	1,700
March	15,000	9,000	3,000	1,900
April	16,000	9,200	3,200	2,000
May	17,000	10,000	3,600	2,200
June	18,000	10,400	4,000	2,300

(b) Credit terms are:

Sales/debtors: 10% sales are on cash, 50% of the credit sales are collected next month and the balance in the following month.

Creditors: Materials 2 months

Wages 1/4 month

Overheads 1/2 month.

(c) Cash and bank balance on 1st April, 2016 is expected to be ₹ 6,000.

(d) other relevant information are:

- (i) Plant and machinery will be installed in February 2016 at a cost of ₹96,000. The monthly instalment of ₹2,000 is payable from April onwards.





- (ii) Dividend @ 5% on preference share capital of ₹2,00,000 will be paid on 1st June.
- (iii) Advance to be received for sale of vehicles ₹9,000 in June.
- (iv) Dividends from investments amounting to ₹1,000 are expected to be received in June.

**Solution:****Cash Budget for the 3 Months Ending 30<sup>th</sup> June 2016 (Amount in ₹)**

Particulars	April	May	June
opening Balance	6,000	3,950	3,000
Add: Receipts :			
Cash Sales	1,600	1,700	1,800
Collection from debtors [see note(1)]	13,050	13,950	14,850
Advance for sale of vehicles	-	-	9,000
Dividends from Investments	-	-	1,000
Total (A+B)	20,650	19,600	29,650
Less: Payments			
Materials	9,600	9,000	9,200
Wages (see note2)	3,150	3,500	3,900
overheads	1,950	2,100	2,250
Instalment of Plant & Machinery	2,000 -	2,000 -	2,000
Preference dividend			10,000
Total (C)	16,700	16,600	27,350
Closing Balance (A+B-C)	3,950	3,000	2,300

**Working Notes:****(i) Computation of Collection from Debtors (Amount in ₹)**

Month	Total Sales	Credit Sales	Feb	Mar	Apr	May	June
Feb	14,000	12,600	---	6,300	6,300	---	---
Mar	15,000	13,500	---	---	6,750	6,750	---
Apr	16,000	14,400	---	---	---	7,200	7,200
May	17,000	15,300	---	---	---	---	7,650
					13,050	13,950	14,850

- (ii) Wages payment in each month is to be taken as three-fourths of the current month plus one-fourth of the previous month.

**Illustration 7**

XYZ Ltd. produces two products, X and Y. and operates three sales divisions for sale of their products. Prepare a sales budget for six months ended 30/06/2016 from the following information.



Budgeted sales for six months ended 31/12/2015:

	Divn. I	Divn. II	Divn. III
Product X	1,600 @ ₹10	2,400 @ ₹10	2,400 @ ₹10
Product Y	800 @ ₹9	4,800 @ ₹9	2,000 @ ₹9

Actual sales during the same period:

Product X	2,000 @ ₹10	3,200 @ ₹10	2,800 @ ₹10
Product Y	400 @ ₹9	4,000 @ ₹9	1,600 @ ₹9

In the management meeting, following decisions have been taken:

- (i) The price of product X should be increased by ₹ 1 as there is a high demand for product X.
- (ii) Product Y is not selling at the expected rate as this product has been over-priced. However, if the selling price is reduced by ₹ 1, it is expected that the market would pick up. Therefore, the divisional sales managers have made the following estimates:

Percentage increase over previous budget (%)

Product	Divn. I	Divn. II	Divn. III
Product X	20%	30%	10%
Product Y	5%	10%	8%

**Solution:**

### Sales Budget

Period: 6 months ended 30/06/2016

Divn.	Product	Budget 30/06/16			Budget 31/12/15			Actual 31/12/15		
		Qty.	Price (₹)	Value (₹)	Qty.	Price (₹)	Value (₹)	Qty.	Price (₹)	Value (₹)
I	X	1,920	11	21,120	1,600	10	16,000	2,000	10	20,000
	Y	840	8	6,720	800	9	7,200	400	9	3,600
	Total	2,760		27,840	2,400		23,200	2,400		23,600
II	X	3,120	11	34,320	2,400	10	24,000	3,200	10	32,000
	Y	5,280	8	42,240	4,800	9	43,200	4,000	9	36,000
	Total	8,400		76,560	7,200		67,200	7,200		68,000
III	X	2,640	11	29,040	2,400	10	24,000	2,800	10	28,000
	Y	2,160	8	17,280	2,000	9	18,000	1,600	9	14,400
	Total	4,800		46,320	4,400		42,000	4,400		42,400
<b>Grand Total</b>		15,960		1,50,720	14,000		1,32,400	14,000		1,34,000

**Illustration 8**

Draw up a flexible budget for overhead expenses on the basis of the following data and determine the overhead rates at 70%, 80% and 90%

Plant Capacity	At 80% capacity (₹)
<b>Variable Overheads:</b>	
Indirect labour	12,000
Stores including spares	4,000
<b>Semi Variable:</b>	
Power (30% - Fixed: 70% -Variable)	20,000
Repairs (60%- Fixed: 40% -Variable)	2,000
<b>Fixed Overheads:</b>	
depreciation	11,000
Insurance	3,000
Salaries	10,000
Total overheads	62,000
Estimated Direct Labour Hours	1,24,000

**Solution:**

**Flexible Budget at Different Capacities and Determination of Overhead Rates**

Particulars	70% (₹)	80% (₹)	90% (₹)
(A) Variable overheads:			
Indirect labour	10,500	12,000	13,500
Stores including spares	3,500	4,000	4,500
Total (A)	14,000	16,000	18,000
(B) Semi Variable overheads:			
Power (See note)	18,250	20,000	21,750
Repairs (See note)	1,900	2,000	2,100
Total (B)	20,150	22,000	23,850
(C) Fixed overheads:			
Depreciation	11,000	11,000	11,000
Insurance	3,000	3,000	3,000
Salaries	10,000	10,000	10,000
Total (C)	24,000	24,000	24,000
Grand Total (A+B+C)	58,150	62,000	65,850
Labour Hours	$\left(1,24,000 \times \frac{7}{8}\right) = 10,8,500$	1,24,000	$\left(1,24,000 \times \frac{9}{8}\right) = 1,39,500$
overhead rate per hour (₹)	$\frac{58,150}{1,08,500} = 0.536$	$\frac{62,000}{1,24,000} = 0.50$	$\frac{65,850}{1,39,500} = 0.472$

**Working notes:** Semi Variable overheads

	70%	90%
Power:		
Variable	$\left(14,000 \times \frac{7}{8}\right) = 12,250$	$\left(14,000 \times \frac{9}{8}\right) = 15,750$
Fixed	6,000	6,000
Total	18,250	21,750
Repairs:		
Variable	$\left(800 \times \frac{7}{8}\right) = 700$	$\left(800 \times \frac{9}{8}\right) = 900$
Fixed	1,200	1,200
Total	1,900	2,100

**Illustration 9**

The profit for the year of Push On Ltd. works out to 12.5% of the capital employed and the relevant figures are as under:

	(₹)
Sales	5,00,000
direct Materials	2,50,000
direct Labour	1,00,000
Variable overheads	40,000
Capital employed	4,00,000

The new sales manager who has joined the company recently estimates for the next year a profit of about 23% on capital employed, provided the volume of sales is increased by 10% and simultaneously there is an increase in selling price of 4% and an overall cost reduction in all the elements of cost by 2%.

Find out by computing in detail the cost and profit for next year, whether the proposal of sales manager can be adopted.

**Solution:****Computation of Fixed Expenses**

Particulars	(₹)
Sales	5,00,000
Less: Profit $[4,00,000 \times (12.5/100)]$	50,000
Total Cost	4,50,000
Less: All costs other than Fixed Cost	3,90,000
Fixed Cost	60,000



**Statement Showing Computation of Profit  
If Salesman's Proposal is Adopted**

Particulars	(₹)
(i) Sales [500000 x 110% x 104%]	5,72,000
(ii) Variable Cost:	
Direct Material [250000 x 110% x 98%]	2,69,500
Direct Labour [100000 x 110% x 98%]	1,07,800
Variable overheads [40000 x 110% x 98%]	43,120
	4,20,420
(iii) Contribution [i - ii]	1,51,580
(iv) Fixed Cost [60000 x 98%]	58,800
(v) Profit [iii - iv]	92,780

$$\% \text{ of profit on Capital Employed} = \left( \frac{92,780}{4,00,000} \times 100 \right) = 23.195\%$$

From the above computation, it was found that the percentage of profit is 23.195% on Capital Employed by adopting the sales manager's proposal which is just more than 23% of expected, therefore the proposal can be adopted.

**Illustration 10**

A glass Manufacturing company requires you to calculate and present the budget for the next year from the following information.

<b>Sales:</b> Toughened glass	₹ 3,00,000
Bent toughened glass	₹ 5,00,000
direct Material cost	60% of sales
direct Wages	20 workers @ ₹150 p.m.
<b>Factory Overheads:</b>	
<b>Indirect Labour:</b> Works Manager	₹ 500 per month
Foreman	₹ 400 per month
Stores and spares	2½% on sales
depreciation on machinery	₹12,000
Light and power	5,600
Repairs and maintenance	8,000
other sundries	10% on direct wages
Administration, selling and distribution expenses	₹14,000 per year.

**Solution:****Master Budget Showing Profit for Next Year**

	(₹)	(₹)
<b>Sales:</b>		
Toughened glass	3,00,000	
Bent Toughened glass	5,00,000	8,00,000
<b>Less: Cost:</b>		
Material @ 60%	4,80,000	
direct Wages (20 x 150 x 12)	36,000	5,16,000
Gross Profit		2,84,000
<b>Less: Factory Overheads:</b>		
Indirect Labour: Works Manager's Salary [500 x 12] = 6,000		
Foreman's Salary [400 x 12] = 4,800	10,800	
Stores & Spares	20,000	
depreciation	12,000	
Light & Power	5,600	
Repairs & Maintenance	8,000	
other Sundries	3,600	
Administration & Selling expenses	14,000	74,000
Profit		2,10,000

**Illustration 11**

Three Articles X, Y and Z are produced in a factory. They pass through two cost centers A and B. From the data furnished compile a statement for budgeted machine utilization in both the centers.

(a) Sales budget for the year

Product	Annual Budgeted Sales (units)	Opening stock of finished products (units)	Closing stock
X	4800	600	equivalent to 2 months sales
Y	2400	300	--do--
Z	2400	800	--do--

(b) Machine hours per unit of product

Product	Cost centers	
	A	B
X	30	70
Y	200	100
Z	30	20



(c) Total number of machines

Cost Centre:	
A	284
B	256
Total	540

(d) Total working hours during the year: estimated 2500 hours per machine.

**Solution:**

**Calculation of Units of Production of Different Products**

Particulars	Product X	Product Y	Product Z
Sales	4800	2400	2400
Add: Closing Stock	800	400	400
	5600	2800	2800
Less: opening stock	600	300	800
Production	5000	2500	2000

**MACHINE UTILISATION BUDGET**

Particulars	A				B			
	X	Y	Z	Total	X	Y	Z	Total
(i) Production (units)	5000	2500	2000		5000	2500	2000	
(ii) Hours per unit	30	200	30		70	100	20	
(iii) Total Machine Hours	1,50,000	5,00,000	60,000	7,10,000	3,50,000	2,50,000	40,000	6,40,000
(iv) Number of Machines Required	60	200	24	284	140	100	16	256

**Illustration 12**

The monthly budgets for manufacturing overhead of a concern for two levels of activity were as follows:

Capacity	60%	100%
Budgeted production (units)	600	1,000
	(₹)	(₹)
Wages	1,200	2,000
Consumable stores	900	1,500
Maintenance	1,100	1,500
Power and fuel	1,600	2,000
depreciation	4,000	4,000
Insurance	1,000	1,000
	9,800	12,000

**You are required to:**

- (i) Indicate which of the items are fixed, variable and semi-variable;  
(ii) Prepare a budget for 80% capacity and  
(iii) Find the total cost, both fixed and variable per unit of output at 60%, 80% and 100% capacity.

**Solution:**

(i)

Fixed → Depreciation and insurance.

Variable → Wages and consumables stores.

Semi-variable Costs → Maintenance, Power and fuel.

Segregation of Semi Variable Costs

$$\text{Maintenance} = \left( \frac{1,500 - 1,100}{400} \right) = ₹ 1 \text{ per unit variable and}$$

₹ 500 fixed (i.e., 1,100-600)

$$\text{Power and fuel} = \left( \frac{2,000 - 1,600}{400} \right) = ₹ 1 \text{ per unit variable and}$$

₹ 1,000 (i.e., 1,600 - 600) is fixed.

(ii) Budget for 80% capacity (output 800 units)

	(₹)
Wages @ ₹ 2 per unit	1,600
Consumables stores @ ₹ 1.50 per unit	1,200
Maintenance: ₹ 500+ ₹ 1.50 per unit	1,300
Power & fuel ₹ 1,000+ ₹ 1 per unit	1,800
depreciation	4,000
Insurance	1,000
Total cost:	10,900

(iii)

Capacity Units	60%		80%		100%	
	600		800		1000	
	Total (₹)	Per unit	Total (₹)	Per unit	Total (₹)	Per unit
Fixed Costs:						
Depreciation	4,000		4,000		4,000	
Insurance	1,000		1,000		1,000	
Maintenance	500		500		500	
Power and fuel	1,000		1,000		1,000	
	6,500	10.83	6,500	8.125	6,500	6.50





Variable costs:						
Wages @ ₹ 2 per unit	1,200		1,600		2,000	
Consumable stores @ ₹ 1.50 per unit	900		1,200		1,500	
Maintenance @ ₹1 Per unit	600		800		1,000	
Power and fuel @ ₹1 per unit	600		800		1,000	
	3,300	5.50	4,400	5.500	5,500	5.50
		16.33		13.625		12.00

**Illustration 13**

X Chemical Ltd. manufacture two products AB and CD by making the raw material in the proportion shown:

Raw Material	Product AB	Product CD
A	80%	
B	20%	
C		50%
d		50%

The finished weight of products AB and CD are equal in the weight of in gradients. During the month of June, it is expected that 60 tons of AB and 200 tons of CD will be sold.

Actual and budgeted inventories for the month of June as follows:

	Actual Inventory (1st June) Quantity (Tons)	Budgeted Inventory (30th June) Quantity (Tons)
A	15	20
B	10	40
C	200	300
D	250	200
Product AB	10	5
Product CD	50	60

The purchase price of materials for June is expected to be as follows:

Material	Cost per ton (₹)
A	500
B	400
C	100
D	200



All materials will be purchased on 3rd of June, Prepare:

- The Production Budget for the month of June,
- The Material Requirement budget for June,
- The Material Purchase Budget indicating the expenditure for material for the month of June.

**Solution:**

**(a) Production Budget**

Particulars	AB	CD
Sales	60	200
Add: Closing stock	5	60
	65	260
Less: opening stock	10	50
Production	55	210

**(b) Material Requirement Budget**

Particulars	A	B	C	D
Product AB	44	11	-	-
Product CD	-	-	105	105
Material Required	44	11	105	105

**(c) Purchase Budget**

Particulars	A	B	C	D
Material Required	44	11	105	105
Add: Closing stock	20	40	300	200
	64	51	405	305
Less: opening stock	15	10	200	250
Purchases (By weight)	49	41	205	55
Cost per ton	500	400	100	200
Purchases (By Rupees)	24500	16400	20500	11000

Total Purchases = ₹ 24500 + 16400 + 20500 + 11000 = ₹ 72400.



## GLOSSARY

**Administration Cost Budget:** Administration Cost Budget is the budget that shows the total estimated of administration, i. e. cost of formulating the policy, directing the organisation and controlling the operations. Most of the expenses relating to administration are of 'fixed' nature within defined limits.

**Budget:** The Terminology (CIMA-London) defines a Budget as a plan quantified in monetary terms, prepared and approved prior to a defined period of time, usually showing planned income to be generated and / or expenditure to be incurred during that period and the capital to be employed to attain a given objective.

**Budget Centre:** A Budget Centre is a section of an organisation developed for the purpose of budgetary control, and is intended to facilitate formulation of various budgets with the help of head of the department.

**Budget Manual:** Budget Manual is a document which contains standing instructions regarding the procedures to be followed at the time of budget preparation.

**Budget Period:** Budget Period is the period for which a budget is prepared and used. It usually covers one year.

**Budgetary Control:** As per CIMA-London Terminology Budgetary Control is the establishment of budgets, relating the responsibilities of executives to the requirements of a policy, and the continuous comparison of actual with budgeted results, either to secure by individual action the objective of that policy or to provide a basis for its revision.

**Budgeted Cost:** Budgeted Cost is an expected cost for the total activity.

**Capital Budget:** Capital Budget is a budget prepared for capital receipts and expenditure such as obtaining loans, issue of shares, purchase of assets etc.

**Capital Expenditure Budget:** Capital Expenditure Budget is a plan for capital expenditure in monetary terms. It is the planned outlay on fixed assets during the budget period.

**Cash Budget:** Cash Budget is a detailed budget of cash income and cash expenditure incorporating both revenue and capital items for the budget period.

**Fixed Budget:** Fixed Budget is the budget designed to remain unchanged irrespective of the level of activity actually attained.

**Flexible Budget:** Flexible Budget is the budget which, by recognising the difference in behaviour between fixed and variable costs in relation to fluctuations in output, turnover, or other variable factors, is designed to change appropriately with such fluctuations.

**Functional Budget:** Functional Budget is the budget prepared for a certain period covering each and every function of the organisation separately.

**Long Term Budget:** Long Term Budget is a budget prepared covering a period of more than a year.

**Master Budget:** Master Budget is a budget which is prepared from the functional budgets in summary form. When all functional budgets are prepared, they are summarised to produce budgeted profit & loss account and budgeted balance sheet.

**Materials Budget:** Materials Budget is the budget that includes quantities of direct materials needed for the finished product in the budget period of an organisation.

**Performance Budgeting:** Performance Budgeting means that the responsibility of various levels of management is predetermined in terms of output or result keeping in view the authority vested with them.



**Personnel Budget:** Personnel Budget is a forecast of planned outlay on direct and indirect labour of a company during the budget period.

**Principal Budget Factor:** The Terminology (CIMA-London) defines Principal Budget Factor or Key Factor or Limiting Factor as a factor which at a particular time or over a period will limit the activities of an organisation and which is therefore, taken into account in preparing budgets.

**Production Budget:** Production Budget is a forecast of the production for the budget period of an organisation.

**Purchase Budget:** Purchase Budget is the budget that establishes the quantity and value of the various items of materials to be purchased for delivery at specified point of time during the budget period taking into account the production schedule and the inventory requirements of the organisation.

**Research & Development Cost Budget (R & D Budget):** Research & Development Cost Budget is a planned outlay on R & D activities of a company.

**Responsibility Accounting:** Responsibility Accounting is the system of accounting that segregates revenues and costs into areas of personal responsibility in order to assess the performance attained by persons to whom authority has been assigned.

**Revenue Budget:** Revenue Budget is a budget covering revenue receipts and expenses for a certain period, such as, sales, purchases, administrative expenses etc.

**Sales Budget:** Sales Budget is the quantitative and financial statement of sales, prepared prior to a defined period of time, to be achieved during that period.

**Selling & Distribution Cost Budget:** Selling & Distribution Cost Budget is a forecast of the cost of selling & distribution of goods during the budget period.

**Short Term Budget:** Short Term Budget is a budget prepared for a period covering a year or less than a year.

**Zero-based Budgeting:** Zero-based Budgeting is defined as a method of budgeting which requires each cost element to be specifically justified, though the activities to which the budget relates are being undertaken for the first time, without approval, the budget allowance is zero.



**Self Learning Questions:**

1. What do you mean by Budgetary Control? State its advantages and limitations.
2. Discuss the preliminaries for the adoption of a system of Budgetary Control.
3. Discuss factors to be considered on Production Budget.
4. Distinguish between Flexible Budget and Fixed Budget.
5. Explain Responsibility Accounting and Performance Budgeting.
6. What do you mean by Zero Based Budgeting? List down the steps involved in zero based budgeting.
7. Explain the various types of Functional Budgets.
8. Write short note on :
  - (a) Sales Budget
  - (b) Cash Budget
  - (c) Personnel Budget
  - (d) Master Budget

**Multiple Choice Questions:**

1. Budget period depends upon...
  - A. The type of budget
  - B. The nature of business
  - C. The length of trade cycles
  - D. All of these
  
2. A key factor is one which restricts...
  - A. The volume of production
  - B. The volume of sales
  - C. The volume of purchase
  - D. All of the above
  
3. Budget relating to the key factor is prepared...
  - A. After other budgets
  - B. With other budgets
  - C. Before other budgets
  - D. None



4. The budgets are classified on the basis of...
  - A. Time
  - B. Function
  - C. Flexibility
  - D. All
  
5. An example of long period budget is...
  - A. R& D budget
  - B. Master budget
  - C. Sales budget
  - D. Personnel budget
  
6. Sales budget shows the sales details as...
  - A. Month wise
  - B. Product wise
  - C. Area wise
  - D. All of the above
  
7. The main objective of budgetary control is...
  - A. To define the goal of the firm
  - B. To coordinate different departments
  - C. To plan to achieve its goals
  - D. All of the above
  
8. Fixed budget is useless for comparison when the level of activity...
  - A. Increases
  - B. Fluctuates both ways
  - C. Decreases
  - D. Constant
  
9. Usually the production budget is stated in terms of...
  - A. Money
  - B. Quantity
  - C. Both
  - D. None



10. Revision of budgets is
- Unnecessary
  - Can't determine
  - Necessary
  - Inadequate data

[Ans: D, A, C, D, A, A, C, B, C, C]

**Match the following:**

	Column A		Column B
1	A budget is a plan of action expressed in...	A	Definite period
2	A budget is tool which helps the management in planning and control of...	B	Management
3	Budgetary control system acts as a friend, philosopher and guide to the...	C	Financial terms & Non-financial terms
4	Budget is prepared for a...	D	Decision making
5	Zero based Budgeting	E	All business activities

[Ans: E, C, B, A, D]

**State whether the following statement is True or False:**

- Zero Based Budgeting cannot be used for Decision making.
- There is necessity to revise the budget.
- A budget is expressed in financial or Quantitative terms.
- A budget is prepared for a specified period.
- A flexible budget takes into account only fixed costs.
- The master budget is prepared first and all other budgets are sub ordinate to it
- The key factor should not be taken into account while preparing budgets.
- A budget is a summary of all functional budgets.
- A flexible budget is prepared for more than one level of activity.
- Cash budget shows the expected sources and utilisation of cash.

[Ans: 1. False, 2. True, 3. True, 4. True, 5. False, 6. False, 7. False, 8. True, 9. True, 10. True]



**Fill in the Blanks:**

1. Budgetary control system facilitates centralized control with \_\_\_\_\_.
2. Budgetary control facilitates easy introduction of the \_\_\_\_\_.
3. Budgetary control helps the management in \_\_\_\_\_.
4. Budgetary control system helps the management to eliminate \_\_\_\_\_.
5. Budgetary control provides a basis for \_\_\_\_\_.
6. Budgetary control helps to introduce a suitable incentive and remuneration based on \_\_\_\_.
7. Budgetary control \_\_\_\_\_ replace management in decision-making.
8. The success of budgetary control system depends upon the willing cooperation of \_\_\_\_\_.
9. Recording of actual performance is \_\_\_\_\_.
10. Revision of budgets is \_\_\_\_\_.

[Ans: 1. Centralised & Decentralised Activity, 2. Standard Costing, 3. Obtaining Bank Credit, 4. Under and Over Capitalisation, 5. Remuneration Plans, 6. Inflationary Conditions, 7. Cannot, 8. All functional area of Management, 9. A step in Budgetary Control, 10. Necessary]





# Study Note - 4

## STANDARD COSTING AND VARIANCE ANALYSIS



### This Study Note includes

- 4.1 Introduction
- 4.2 Computation of Variances for each of the Elements of Costs, Sales Variances
- 4.3 Investigation of Variances & Reporting of Variances
- 4.4 Valuation of Stock under Standard Costing
- 4.5 Uniform Costing and Inter-firm Comparison

### 4.1 INTRODUCTION

During the first stages of development of cost accounting, historical costing was the only method available for ascertaining and presenting costs. Historical costs have, however, the following limitations:

- (a) Historical cost is valid only for one accounting period, during which the particular manufacturing operation took place.
- (b) Data is obtained too late for price quotations and production planning.
- (c) Historical cost relating to one batch or lot of production is not a true guide for fixing price.
- (d) Past actual are affected by the level of working efficiencies.
- (e) Historical costing is comparatively expensive as it involves the maintenance of a large volume of records and forms.

The limitations and disadvantages attached to historical costing system led to further thinking on the subject and resulted in the emergence of standard costing which makes use of scientifically predetermined standard costs under each element.

#### Definition:

**Standard Cost:** Standard Cost is a technique which uses standards for costs and revenues for the purpose of control through variance analysis.

Standard Costing is defined as "the preparation and use of standard cost, their comparison with actual costs and the measurement and analysis of variances to their causes and points of incidence."

#### Needs for Adoption of Standard Costing

Standard Costing System is widely accepted as it serves the different needs of an organisation. The standard costing is preferred for the following reasons:

- (i) *Prediction of future cost for decision making:* Standard costs are set after taking into account all the future possibilities and can be termed as future cost. Standard cost is used for calculating profitability from a project/order/activity proposed to be undertaken. Hence, standard cost is very useful for decision making purpose.



- (ii) *Provide target to be achieved:* Standard costs are the target cost which should not be crossed by the responsibility centres. Performance of a responsibility centre is continuously monitored and measured against the set standards. Any variance from the standard is noted and reported for appropriate action.
- (iii) *Used in budgeting and performance evaluation:* Standard costs are used to fix budgets and based on these budgets managerial performance is evaluated. There are two advantages: (a) the managers of a responsibility centre will not compromise with the quality to fulfil the budgeted quantity and (b) variances can be traced with the responsible department or person.
- (iv) *Interim profit measurement and inventory valuation:* Actual profit is known only after the closure of the account. Few organisations use to prepare profitability statement for interim period also for management reporting purpose. The standard costs are deducted from the revenue to arrive at the profit figure.

### **General Principles of Standard Costing**

1. Predetermination of technical data related to production. i.e., details of materials and labour operations required for each product, the quantum of inevitable losses, efficiencies expected, level of activity, etc.
2. Predetermination of standard costs in full details under each element of cost, viz., labour, material and overhead.
3. Comparison of the actual performance and costs with the standards and working out the variances, i.e., the differences between the actuals and the standards.
4. Analysis of the variances in order to determine the reasons for deviations of actuals from the standards.
5. Presentation of information to the appropriate level of management to enable suitable action (remedial measures or revision of the standards) being taken.

### **Difference between Standard Costing and Budgetary Control**

Like Budgetary Control, Standard Costing assume that costs are controllable along definite lines of supervision and responsibility and it aims at managerial control by comparison of actual performances with suitable predetermined yardsticks. The basic principles of cost control, viz., setting up of targets or standards, measurement of performance, comparison of actual with the targets and analysis and reporting of variances are common to both standard costing and budgetary control systems. Both techniques are of importance in their respective fields are complementary to each other. Thus, conceptually there is not much of a difference between standard costs and budgeted and the terms budgeted performance and standard performance mean, for many concerns one and the same thing.

Budgets are usually based on past costs adjusted for anticipated future changes but standard costs are of help in the preparation of production costs budgets. In fact, standards are often indispensable in the establishment of budgets. On the other hand, while setting standard overhead rates of standard costing purposes, the budgets framed for the overhead costs may be made use of with modifications, if necessary. Thus, standard costs and budgets are interrelated but not inter-dependent.

Despite the similarity in the basic principles of Standard Costing and Budgetary Control, the two systems vary in scope and in the matter of detailed techniques. The difference may be summarized as follows:

1. A system of Budgetary Control may be operated even if no Standard Costing system is in use in the concern.
2. While standard is an unit concept, budget is a total concept.



3. Budgets are the ceilings or limits of expenses above which the actual expenditure should not normally rise; if it does, the planned profits will be reduced. Standards are minimum targets to be attained by actual performance at specified efficiency.
4. Budgets are complete in as much as they are framed for all the activities and functions of a concern such as production, purchase, selling and distribution, research and development, capital utilisation, etc. Standard Costing relates mainly to the function of production and the related manufacturing costs.
5. A more searching analysis of the variances from standards is necessary than in the case of variations from the budget.
6. Budgets are indices, adherence to which keeps a business out of difficulties. Standards are pointers to further possible improvements.

### **Advantages of Standard Costing**

The advantages derived from a system of standard costing are tabulated below:

1. Standard Costing system establishes yard-sticks against which the efficiency of actual performances is measured.
2. The standards provide incentive and motivation to work with greater effort and vigilance for achieving the standard. This increase efficiency and productivity all round.
3. At the very stage of setting the standards, simplification and standardisation of products, methods, and operations are effected and waste of time and materials is eliminated. This assists in managerial planning for efficient operation and benefits all the divisions of the concern.
4. Costing procedure is simplified. There is a reduction in paper work in accounting and less number of forms and records are required.
5. Cost are available with promptitude for various purposes like fixation of selling prices, pricing of interdepartmental transfers, ascertaining the value of costing stocks of work-in-progress and finished stock and determining idle capacity.
6. Standard Costing is an exercise in planning - it can be very easily fitted into and used for budgetary planning.
7. Standard Costing system facilities delegation of authority and fixation of responsibility for each department or individual. This also tones up the general organisation of the concern.
8. Variance analysis and reporting is based on the principles of management by exception. The top management may not be interested in details of actual performance but only in the variances from the standards, so that corrective measures may be taken in time.
9. When constantly reviewed, the standards provide means for achieving cost reduction.
10. Standard costs assist in performance analysis by providing ready means for preparation of information.
11. Production and pricing policies may be formulated in advance before production starts. This helps in prompt decision-making.
12. Standard costing facilitates the integration of accounts so that reconciliation between cost accounts and financial accounts may be eliminated.
13. Standard Costing optimizes the use of plant capacities, current assets and working capital.



### Limitations of standard costing

1. Establishment of standard costs is difficult in practice.
2. In course of time, sometimes even in a short period the standards become rigid.
3. Inaccurate, unreliable and out of date standards do more harm than benefit.
4. Sometimes, standards create adverse psychological effects. If the standard is set at high level, its non achievement would result in frustration and build-up of resistance.
5. Due to the play of random factors, variances cannot sometimes be properly explained, and it is difficult to distinguish between controllable and non-controllable expenses.
6. Standard costing may not sometimes be suitable for some small concerns. Where production cannot be carefully scheduled, frequent changes in production conditions result in variances. Detailed analysis of all of which would be meaningless, superfluous and costly.
7. Standard costing may not, sometimes, be suitable and costly in the case of industries dealing with non-standardized products and for repair jobs which keep on changing in accordance with customer's specifications.
8. Lack of interest in standard costing on the part of the management makes the system practically ineffective. This limitation, of course, applies equally in the case of any other system which the management does not accept wholeheartedly.

## 4.2 COMPUTATION OF VARIANCES FOR EACH OF THE ELEMENTS OF COSTS, SALES VARIANCES

### Variance Analysis

Variance Analysis is nothing but the differences between Standard Cost and Actual Cost. of course, in ordinary language we call it difference; in statistics we call it deviations and in costing terminology we call it as variances. When Standard Costing is adopted, the standards are set for all the costs, revenue and profit, and if the difference in case of cost is more than the standard we call it adverse variance, symbolized (A) and if the difference is less than the standard, we call it favourable variance, symbolized (F). However, in case of sales and profit, if the standard is more than the actual it is adverse variance and if the standard is less than the actual it is favourable variance. From this we understand that variances can be calculated in all the elements of costs, sales and profit too.

An overview of Variance Analysis is shown as follows:

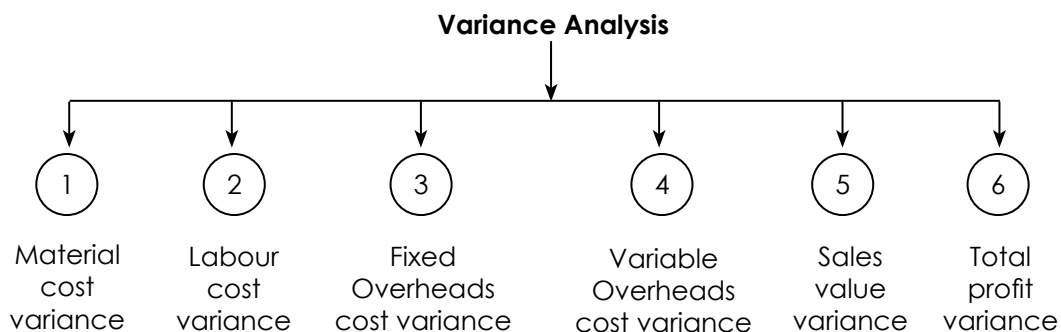

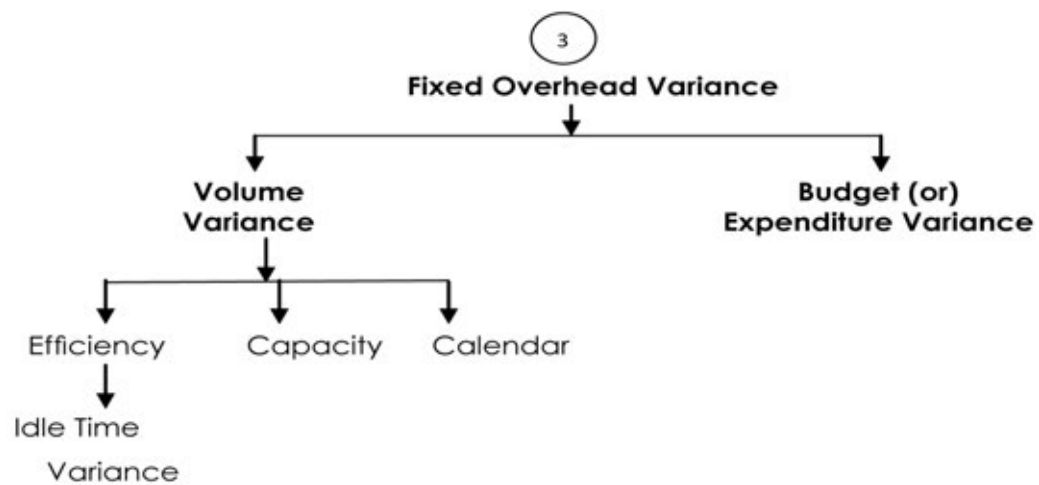
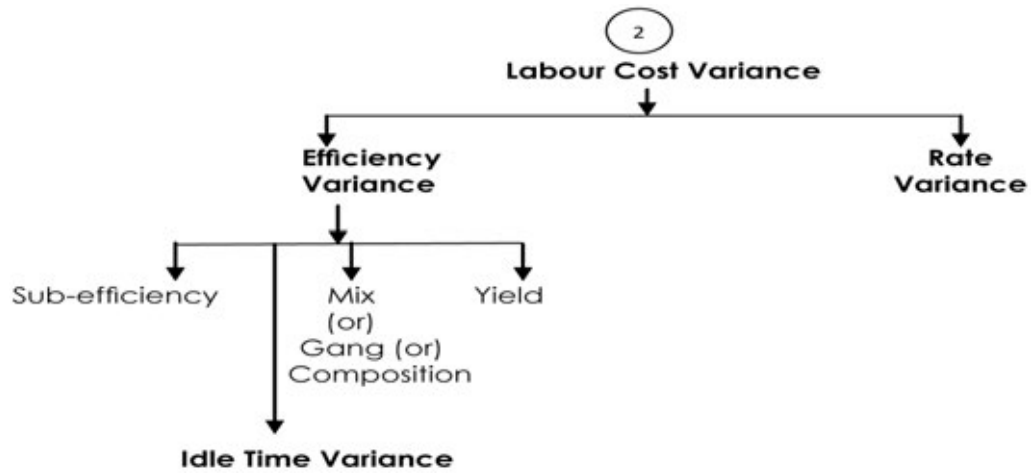
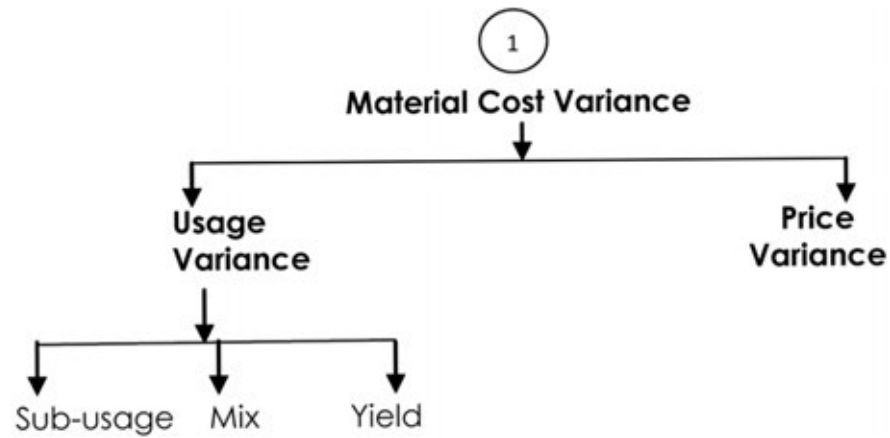

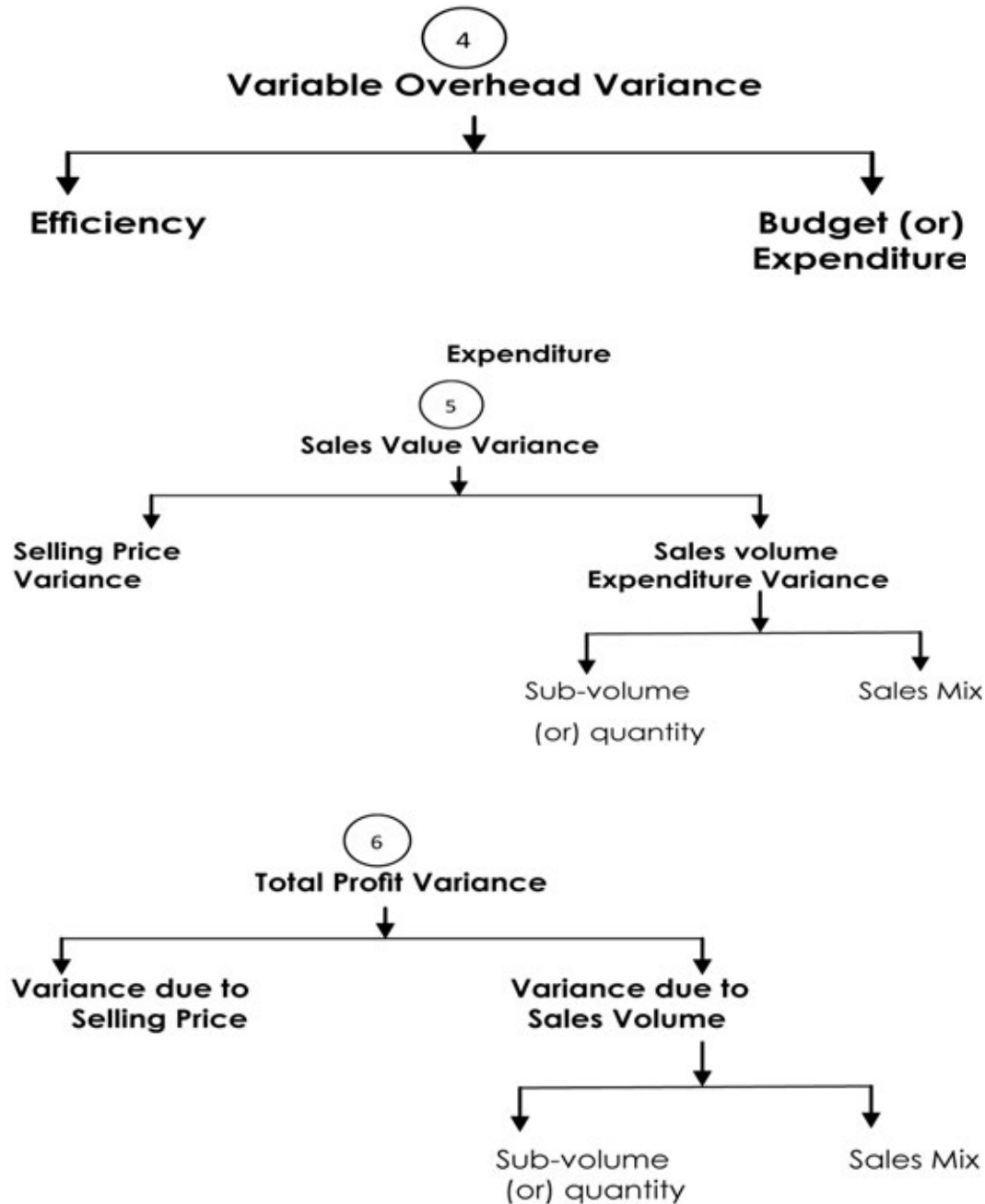

### DIRECT MATERIALS COST VARIANCE

Direct materials cost variance is the difference between the actual direct material cost incurred and the standard direct material cost specified for the production achieved.

*Causes for Variance:* Material cost variance arises mainly because of either difference in material price from the Standard price or difference in material consumption from standard consumption or because of both reasons.

1. **Direct Materials Price Variance:** The difference between the actual and standard price per unit of the material applied to the actual quantity of material purchased or used is called Direct Material Price Variance.



$$\begin{aligned} \text{Direct materials price variance} &= (\text{Standard Price} \textit{ minus} \textit{ Actual Price}) \times \text{Actual Quantity, or} \\ &= (\text{SP}-\text{AP}) \text{ AQ} \\ &= (\text{Standard Price} \times \text{Actual Quantity}) \textit{ minus} \textit{ (Actual Price} \times \text{Actual Quantity)} \\ &= (\text{AQSP}-\text{AQAP}) \end{aligned}$$

### Causes of Material Price Variance

- a. Change in basic purchase price of material.
- b. Change in quantity of purchase or uneconomical size of purchase order.
- c. Rush order to meet shortage of supply, or purchase in less or more favourable market.
- d. Failure to take advantage of off-season price, or failure to purchase when price is cheaper.
- e. Failure to obtain (or availability of) cash and trade discounts or change in the discount rates.
- f. Weak purchase organisation.
- g. Payment of excess or less freight.
- h. Transit losses and discrepancies, if purchase price is inflated to include the loss.
- i. Change in quality or specification of material purchased.
- j. Use of substitute material having a higher or lower unit price.
- k. Change in materials purchase, upkeep, and store-keeping cost. (This is applicable only when such changes are allocated to direct material costs on a predetermined or standard cost basis.)
- l. Change in the pattern or amounts of taxes and duties.

*Responsibility for Material Price Variance:* Generally, purchase department purchases materials from the market. Purchase department is expected to perform its function prudently so that company never suffers loss due to its inefficiency. Purchase department is held responsible for adverse price variance that arises due to the factors controllable by the department.

2. **Direct Materials Usage Variance:** The difference between the actual quantity used and the amount which should have been used, valued at standard price is called Direct Material Usage Variance.

$$\begin{aligned} \text{Direct materials usage variance} &= (\text{Standard Quantity for actual output} \times \text{Standard Price}) \textit{ minus} \\ &\text{(Standard Price} \times \text{Actual Quantity)} \\ &= \text{SQSP}-\text{AQSP} \textit{ or} \\ &= \text{Standard Price} \times (\text{Standard Quantity for actual output} \textit{ minus} \textit{ Actual Quantity)} \\ &= \text{SP} (\text{SQ}-\text{AQ}) \end{aligned}$$

### Causes of Materials Usage Variance

- a. Variation in usage of materials due to inefficient or careless use, or economic use of materials.
- b. Change in specification or design of product.
- c. Inefficient and inadequate inspection of raw materials.
- d. Purchase of inferior materials or change in quality of materials
- e. Rigid technical specifications and strict inspection leading to more rejections which require more materials for rectification.
- f. Inefficiency in production resulting in wastages



- g. Use of substitute materials.
- h. Theft or pilferage of materials.
- i. Inefficient labour force leading to excessive utilisation of materials.
- j. Defective machines, tools, and equipments, and bad or improper maintenance leading to breakdowns and more usage of materials.
- k. Yield from materials in excess of or less than that provided as the standard yield.
- l. Faulty materials processing. Timber, for example, if not properly seasoned may be wasted while being used in subsequent processes.
- m. Accounting errors, e.g. when materials returned from shop or transferred from one job to another are not properly accounted for.
- n. Inaccurate standards
- o. Change in composition of a mixture of materials for a specified output.

*Responsibility for Material Usage Variance:* Material usage is the responsibility of production department and it is held responsible for adverse usage variance.

**(i) Direct Materials Mix Variance:** Material Mix Variance is that part of material usage variance which arises from the difference between the standard mix and actual mix of different types of materials used in production. One of the reasons for materials usage variance is the change in the composition of the materials mix. The difference between the actual quantity of material used and the standard proportion, priced at standard price.

$$\begin{aligned} \text{Mix variance} &= (\text{Revised Standard Quantity minus Actual Quantity}) \times \text{Standard Price.} \\ &= \text{RSQSP} - \text{AQSP} \end{aligned}$$

**(ii) Direct Materials Yield Variance:** Yield variance is the difference between the standard cost of production achieved and the actual total quantity of materials used, multiplied by the standard weighted average price per unit.

$$\text{Material yield variance} = (\text{Standard yield for Actual Mix} \textit{ minus} \text{ Actual yield}) \times \text{Standard yield Price}$$

(Standard yield price is obtained by dividing the total cost of the standard units by the total cost of the standard mixture by the total quantity (number of physical units).

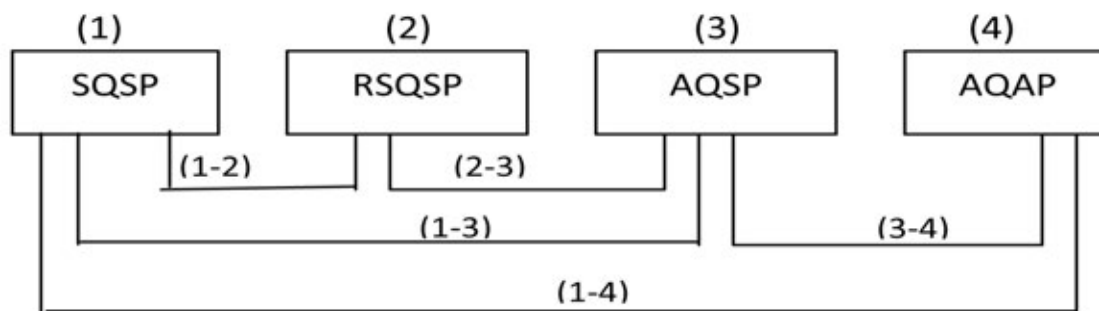

Where

SQ = Standard Quantity for Actual Production or output

SP = Standard Price

AQ = Actual Quantity of Materials Consumed

AP = Actual Price





RSQ = Revised Standard Quantity

1. SQSP = Standard Cost of Standard Material
2. RSQSP = Revised Standard Cost of Standard Material
3. AQSP = Standard cost of Actual Material
4. AQAP = Actual Cost of Actual Material
  - (a) Material Sub-usage or yield Variance = 1-2
  - (b) Material Mix Variance = 2-3
  - (c) Material usage Variance = 1-3
  - (d) Material Price Variance = 3-4
  - (e) Material Cost Variance = 1-4

### DIRECT LABOUR COST VARIANCE

Direct Labour Cost Variance (also termed Direct Wage Variance) is the difference between the actual direct wages incurred and the standard direct wages specified for the activity achieved.

1. **Direct Labour Rate Variance (Wage Rate Variance):** The difference between the actual and standard wage rate per hour applied to the total hours worked is called Direct Labour Rate Variance.

$$\begin{aligned} \text{Wages rate variance} &= (\text{Standard Rate} \textit{ minus} \textit{ Actual Rate}) \times \text{Actual Hours} \\ &= (\text{SR}-\text{AR}) \times \text{AH} \\ &= \text{SRAH}-\text{ARAH} \end{aligned}$$

### Causes of Direct Labour Rate Variances

- a. Change in basic wage structure or change in piece-work rate. These will give rise to a variance till such time the standards are not revised.
- b. Employment of workers of grades and rates of pay different from those specified, due to shortage of labour of the proper category, or through mistake, or due to retention of surplus labour.
- c. Payment of guaranteed wages to workers who are unable to earn their normal wages if such guaranteed wages form part of direct labour cost.
- d. Use of a different method of payment, e.g. payment at day-rates while standards are based on piece-work method of remuneration.
- e. Higher or lower rates paid to casual and temporary workers employed to meet seasonal demands, or urgent or special work.
- f. New workers not being allowed full normal wage rates.
- g. Overtime and night shift work in excess of or less than the standard, or where no provision has been made in the standard. This will be applicable only if overtime and shift differential payments form part of the direct labour cost.
- h. The composition of a gang as regards the skill and rates of wages being different from that laid down in the standard.

*Responsibility for Labour Rate Variance:* Labour rates are generally, influenced by the external factors which are beyond the control of the organisation. However, personnel manager is responsible for labour rate negotiation.



2. **Direct Labour Efficiency Variance (also termed Labour Time Variance):** The difference between the standard hours which should have been worked and the hours actually worked, valued at the standard wage rate is called Direct Labour Efficiency Variance.

$$\begin{aligned}\text{Direct Labour efficiency Variance} &= (\text{Standard Hours for Actual Production} \textit{ minus} \textit{ Actual Hours}) \times \\ &\quad \text{Standard Rate} \\ &= (\text{SH}-\text{AH}) \times \text{SR} \\ &= \text{SRSH}-\text{SRAH}\end{aligned}$$

### Causes for Labour Efficiency Variance

- a. Lack of proper supervision or strict supervision than specified.
- b. Poor working conditions.
- c. Delays due to waiting for materials, tools, instructions, etc. if not treated as idle time.
- d. Defective machines, tools and other equipments.
- e. Machine break-down, if not booked to idle time.
- f. Work on new machines requiring less time than provided for, till such time standard is not revised.
- g. Basic inefficiency of workers due to low morale, insufficient training, faulty instructions, incorrect scheduling of jobs, etc.
- h. Use of non-standard material requiring more or less operation time.
- i. Carrying out operations not provided for a booking them as direct wages.
- j. Incorrect standards
- k. Wrong selection of workers, i.e., not employing the right type of man for doing a job.
- l. Increase in labour turnover.
- m. Incorrect recording of performances, i.e., time or output.

*Responsibility for Labour Efficiency Variance:* Efficiency variance may arise due to ability of the workers, inappropriate team of workers, inefficiency of production manager or foreman etc. However, production manager or foreman can be held responsible for the adverse variance which otherwise can be controlled. Labour efficiency variance is further divided into:

- (i) Labour Mix Variance or Gang variance
- (ii) Labour Yield Variance (or Labour Revised-efficiency Variance)
- (iii) Idle Time Variance

- (i) **Direct Labour Composition or Mix or Gang Variance:** Labour Mix Variance is the variance which arises due to change in the proportion or combination of different skill set i.e. number of skilled workers, semi-skilled workers and unskilled workers. This is a sub-variance of labour efficiency variance. This variance arises due to change in the composition of a standard gang, or, combination of labour force

$$\text{Mix or gang or Composition Variance} = (\text{Actual Hours at Standard Rate of Standard gang}) \textit{ minus} (\text{Actual Hours at Standard Rate of Actual gang})$$

- (ii) **Direct Labour Yield Variance:** Just as material yield variance is calculated, similarly labour yield variance can also be known. It is the variation in labour cost on account of increase or decrease in yield or output as composed to the relative standard. The formula is –

$$\text{Direct Labour yield Variance} = \text{Standard Cost Per unit} \times [\text{Standard Output for Actual Mix} - \text{Actual Output}]$$



**(iii) Idle time variance:** Idle Time Variance is the standard cost of actual time paid to workers for which they have not worked due to abnormal reasons. This variance which forms a portion of wages efficiency variance, is represented by the standard cost of the actual hours for which the workers remain idle due to abnormal circumstances.

Idle time variance = (Standard rate x Actual hours paid for) minus (Standard rate x Actual hours worked) or

= Standard Rate x Idle Hours

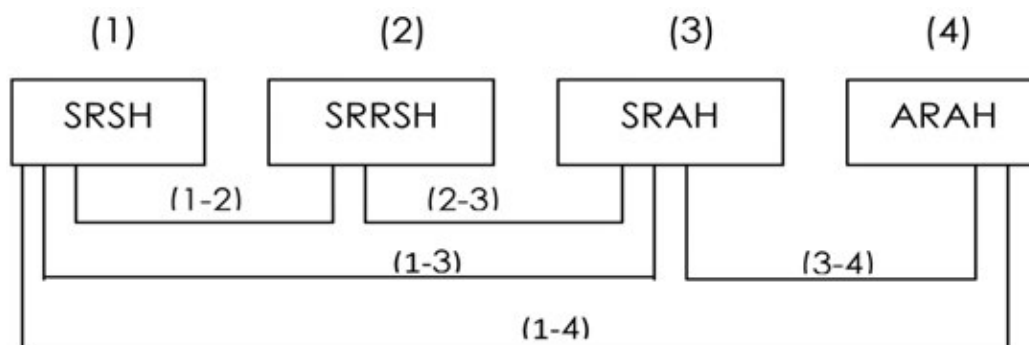

SR = Standard Rate of Labour Per Hour

SH = Standard Hours for Actual Production or output

RSH = Revised Standard Hours

AH = Actual Hours

AR = Actual Rate of Labour per Hour

1. SRSH = Standard Cost of Standard Labour

2. SRRSH = Revised Standard Cost of Labour

3. SRAH = Standard Cost of Actual Labour

4. ARAH = Actual Cost of Labour

- a. Labour Sub-efficiency or yield Variance = 1-2
- b. Labour Mix or gang or Composition Variance = 2-3
- c. Labour efficiency Variance = 1-3
- d. Labour Rate Variance = 3-4
- e. Labour Cost Variance = 1-4

Idle Time Variance = Idle Time Hours x Standard Rate per Hour.

It is to be noted that this is the part and parcel of efficiency ratio and always it is adverse.

### OVERHEAD COST VARIANCE

Overhead Cost Variance is the difference between the standard cost of overhead allowed for actual output and the actual overhead incurred. Overhead cost variance or overall (or net) overhead variance is the difference between the actual overhead incurred and the overhead charged or applied into the job or process at the standard overhead rate.



### Fixed Overhead Variance

Fixed overhead cost variance is the difference between the standard cost of fixed overhead allowed for the actual output achieved and the actual fixed overhead cost incurred. The fixed overhead variance is analysed as below:

#### (i) Budget (or) Expenditure (or) Spending Variance

**Fixed Overhead Expenditure Variance:** Fixed Overhead Expenditure Variance is the difference between the actual fixed overhead incurred and budgeted fixed overhead.

Fixed overhead variance which arises due to the difference between the budgeted fixed overheads and the actual fixed overheads incurred during a particular period. It shows the efficiency in spending. Expenditure variance arises due to the following:

- Rise in general price level.
- Changes in production methods.
- Ineffective control.

Fixed overhead expenditure or Budget Variance = Budgeted Fixed overhead – Actual Fixed overhead

#### (ii) Volume Variance

Fixed overhead volume variance is the difference between standard cost of fixed overhead allowed for actual output and the budgeted fixed overheads for the period. This variance shows the over (or) under absorption of fixed overheads during a particular period. If the actual output is more than the budgeted output then there will be over recovery of fixed overheads and volume variance will be favourable and vice-versa. This is so because fixed overheads are not expected to change with the change in output. Volume variance arises due to the following reasons:

- Poor efficiency of workers.
- Poor efficiency of machinery.
- Lack of orders.
- Shortage of power.
- Ineffective supervision.
- More or less working days.

Volume variance (Fixed Overhead) = Recovered Fixed overhead - Budgeted Fixed overhead

Volume variance can be further sub divided into three variances namely:

##### a. Capacity Variance

It is that portion of the volume variance which occurs due to working at higher or lower capacity than the standard capacity. In other words, the variance is related to the under and over utilization of plant and equipment and arises due to idle time, strikes and lock-out, break down of the machinery, power failure, shortage of materials and labour, absenteeism, overtime, changes in number of shifts. In short, this variance arises due to more or less working hours than the budgeted working hours.

Capacity Variance = Standard Fixed Overhead Rate per hour × [Actual Hour worked - Budgeted Hours]

Or

= Standard overhead - Budgeted overheads

##### b. Calendar Variance

It is that portion of the volume variance which is due to the difference between the number of working days in the budget period and the number of actual working days in the period to which



the budget is applicable. If the actual working days are more than the budgeted working days the variance will be favourable and vice-versa if the actual working days are less than the budgeted days.

Calendar Variance = Standard Rate Per Hour or Per Day × excess or Deficit Hours or Days Worked

### c. Efficiency Variance

It is that portion of the volume variance which is due to the difference between the budgeted efficiency of production and the actual efficiency achieved.

Efficiency Variance = Standard Fixed Overhead Rate per hour × [Standard Hour for Actual Production – Actual Hours]

Or

= Recovered Fixed Overheads – Standard Fixed Overheads

### Fixed Overhead Variances

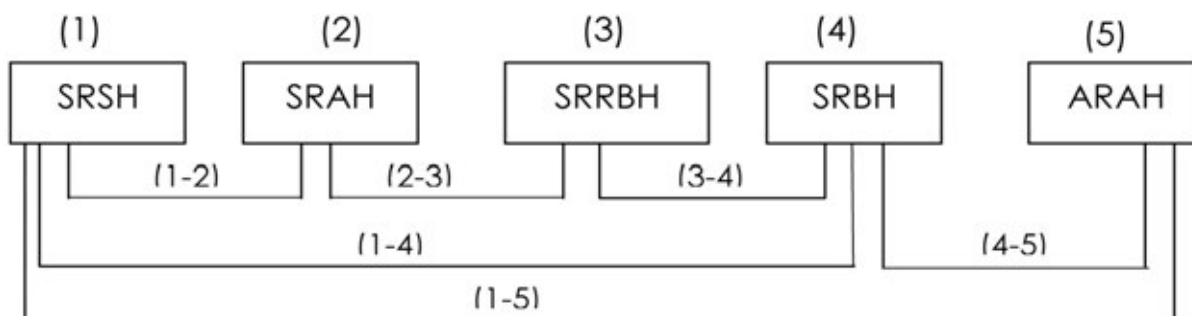

Where,

SR = Standard Rate of Fixed overhead Per Hour

SH = Standard Hours for Actual Production or output

AH = Actual Hours

RBH = Revised Budgeted Hours

BH = Budgeted Hours

AR = Actual Rate of Fixed over Head per Hour

1. SRSH = Standard Cost of Standard Fixed overhead
2. SRAH = Standard Cost of Actual Fixed overhead or Fixed overhead Absorbed or Recovered
3. SRRBH = Revised Budgeted Fixed overhead
4. SRBH = Budgeted Fixed overhead
5. ARAH = Actual Fixed overhead
  - a. Fixed overheads efficiency Variance = 1-2
  - b. Fixed overheads Capacity Variance = 2-3
  - c. Fixed overhead Calendar Variance = 3-4
  - d. Fixed overhead Volume Variance = 1-4
  - e. Fixed overhead Budget or expenditure Variance = 4-5
  - f. Fixed overhead Cost Variance = 1-5



**Note 1:** - In the above values SR is found out in the following manner.

**Note 2:** Fixed overhead variances can also be worked out using overhead rate per unit instead of rate per hour. In that event values and variances would be as follows:

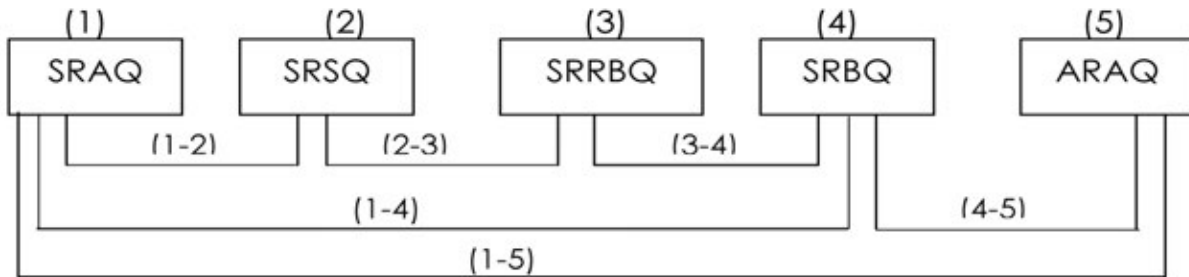

Where,

SR = Budgeted Fixed overheads / Budgeted Quantity

1. SRSQ = Standard Cost of Standard Fixed overhead
2. SRAQ = Standard Cost of Actual Fixed overhead or Fixed overhead Absorbed or Recovered
3. SRRBQ = Revised Budgeted Fixed overhead
4. SRBQ = Budgeted Fixed overhead
5. ARAQ = Actual Fixed overhead
  - a. Fixed overheads efficiency Variance = 1-2
  - b. Fixed overheads Capacity Variance = 2-3
  - c. Fixed overhead Calendar Variance = 3-4
  - d. Fixed overhead Volume Variance = 1-4
  - e. Fixed overhead Budget or expenditure Variance = 4-5
  - f. Fixed overhead Cost Variance = 1-5

**Note 3:-** Idle time variance in fixed overhead is part and parcel of efficiency variance and it is always adverse.

### Variable overhead variance

This is the difference between the standard variable overhead cost allowed for the actual output achieved and the actual variable overhead cost. The variance is represented by expenditure variance only because variable overhead cost will vary in proportion to output so that only a change in expenditure can cause such variance.

Sometimes, variable overhead efficiency variance can also be calculated just like labour efficiency variance. Variable overhead efficiency can be calculated if information relating to actual time taken and time allowed is given. In that event variable overhead variance can be divided into two parts.

- (i) Variable overhead efficiency variance.
- (ii) Variable overhead expenditure (or) budget (or) price variance.

Idle Time Variance = Idle Time Hours x Fixed overhead Rate per Hour

**(i) Efficiency Variance:** This variance is due to the difference between standard hours for actual output and the actual hours taken at the standard variable overhead rate. In other words, Variable overhead efficiency Variance is a measure of the extra overhead (or saving) incurred



solely because direct labour usage exceeded (or was less than) the standard direct labour hours allowed.

$$\text{Efficiency Variance} = \text{Standard Variable overhead Rate per Hour} \times [\text{Standard Hours for Actual production} - \text{Actual Hours}]$$

$$= \text{Recovered Variable overheads} - \text{Standards Variable overheads}$$

**(ii) Expenditure or Budget or Price Variance:** This variance is due to the difference between standard variable overhead rate and actual variable overhead rate for the actual time taken. It is calculated on the pattern of Direct Labour rate Variance.

$$\text{Expenditure Variance} = \text{Actual Time} \times [\text{Standard Variable overhead Rate per Hour} - \text{Actual Variable overhead rate per hour}]$$

$$= \text{Standard Variable overheads} - \text{Actual Variable overheads}$$

## SALES VARIANCE

Sales variance is the difference between actual sales and budgeted sales.

The analysis of variances will be complete only when the difference between the actual profit and standard profit is fully analysed. It is necessary to make an analysis of sales variances to have a complete analysis of profit variance, because profit is the difference between sales and cost. Thus, in addition to the analysis of cost variances i.e., material cost variance, labour cost variance and overhead variance, an analysis of sales variance should be made. Sales variances analysis may be categorized into two:

1. Sales Value (or) Revenue variance
2. Sales Margin (or) Profit variance

**1. Sales Value Variance:** Sales Value Variance is the difference between the budgeted value of sales and the actual value of sales during a period. If the actual sales are more than the budgeted sales, a favourable variance would be shown and vice versa. The formula is:

$$\text{Sales Value variance} = \text{Budgeted Sales} - \text{Actual Sales}$$

Sales Value Variance may arise due to the following reasons:

- (a) Actual selling price may be higher or lower than the standard price.
- (b) Actual quantity of goods sold may be more or less than the standard.
- (c) Actual mix of the sales may be different than the standard mix.

Sales Margin Variance is the difference between the budgeted profit and actual profit and this is also the sum total of all variances. Sales Margin Variance may arise due to the following reasons:

- (i) Rise in general price level
- (ii) Unexpected competition
- (iii) Ineffective sales promotion

**(i) Price Variance:** Sales Price Variance is the difference in actual selling price and the standard selling price for actual quantity of sales. This can be calculated just like Material Price Variance. It is an account of the difference in actual selling price and the standard selling price for actual quantity of sales. The formula for this is:

$$\text{Price variance} = \text{Actual Quantity Sold} \times (\text{Standard Price} - \text{Actual Price})$$

Or

$$= \text{Standard Sales} - \text{Actual Sales}$$



- (ii) **Volume Variance:** Sales Volume Variance is the different between budgeted sales and standard sales. It can be computed as Material usage Variance. Budgeted sales may be different from the standard sales. In other words, budgeted quantity of sales at standard prices may vary from the actual quantity of sales at standard prices. Thus, the variance is as a result of difference in budgeted and actual quantities of goods sold. The formula is:

$$\text{Volume Variance} = \text{Standard Price} \times (\text{Budgeted Quantity} - \text{Actual Quantity})$$

Or

$$= \text{Budgeted Sales} - \text{Standard Sales}$$

- (a) **Mix variance:** Sales Mix Variance occurs when the actual quantities sold are not in the same proportion as budgeted. When more than one product is manufactured and sold, the budgeted sales of different products are in a given ratio. If the actual quantities sold are not in the same proportion as budgeted, it would cause a mix variance.

It can be calculated according to two methods:

- Based on Quantity: This method is followed on those cases where products are homogenous. In case the formula for calculating Sales Mix Variance is on the same pattern as is used in case of Material Mix Variance.

$$\text{Mix Variance} = \text{Standard Price} \times (\text{Revised Standard Quantity} - \text{Actual Quantity})$$

$$= \text{Revised Standard Sales} - \text{Standard Sales}$$

If actual quantity is more than the revised standard quantity, it will result in favourable variance or vice versa.

$$\text{Revised Standard Quantity} = \frac{\text{Total Quantity of Actual Mix}}{\text{Total Quantity of Standard Mix}} \times \text{Standard Quantity}$$

- Based on Value: This method is followed in those cases where products are not homogeneous. In such a case, the actual sales at standard prices, i.e. standard sales are to be expressed in budgeted ratios so as to calculate 'revised standard sales' and then is compared with the actual sales at standard prices. The formula is:

$$\text{Mix Variance} = \text{Revised Standard Sales} - \text{Standard Sales}$$

$$\text{Revised Standard Sales} = \text{Budgeted Ratio of Sales} \times \text{Standard Sales}$$

$$\text{Budgeted Ratio of Sales} = \frac{\text{Budgeted Sales of a Product}}{\text{Total Budgeted Sales}}$$

- (b) **Quantity Variance:** Sales Quantity Variance is the difference between budgeted sales and the revised standard sales. The formula is:

$$\text{Quantity variance} = \text{Budgeted Sales} - \text{Revised Standard Sales}$$

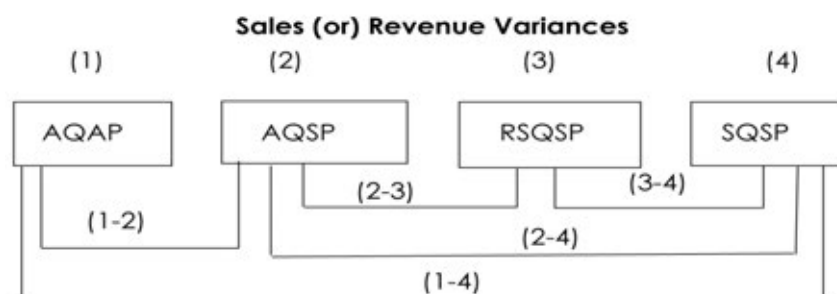





Where,

AQ = Actual Quantity Sold

AP = Actual Selling Price

SP (or) BP = Standard Selling Price (or) Budgeted Price

RSQ = Revised Standard Quantity

SQ (or) BQ = Standard (or) Budgeted Quantity

1. AQAP = Actual Sales
2. AQSP = Actual Quantity of Sales at Standard Selling Prices.
3. RSQSP = Revised Standard or Budgeted Sales.
4. SQSP = Standard (or) Budgeted Sales.
  - a. Sales Sub-Volume (or) Quantity Variance = 3 - 4
  - b. Sales Mix Variance = 2 - 3
  - c. Sales Volume Variance = 2 - 4
  - d. Sales Price Variance = 1 - 2
  - e. Total Sales Value Variance = 1 - 4

### PROFIT VARIANCE

Profit Variance is the difference between budgeted profit and actual profit. This represents the difference between budgeted profit and actual profit. The formula is:

Profit Variance = Budgeted Profit – Actual Profit

- (i) Price Variance:** Profit Price variance is the difference between standard and actual profit on actual volume of sales. It shall be equal to the price variance calculated with reference to turnover. It represents the difference of standard and actual profit on actual volume of sales. The formula is:

Price Variance = Standard Profit – Actual Profit

Or

= Actual Quantity Sold × (Standard Profit per unit - Actual Profit per unit)

- (ii) Volume Variance:** Profit Volume Variance is the difference between the standard and the actual volume of sales. The profit at the standard rate on the difference between the standard and the actual volume of sales would be the amount of volume variance. The formula is:

Volume Variance = Budgeted Profit – Standard profit

Or

= Standard Rate of Profit × (Budgeted Quantity - Actual Quantity)

The Volume Variance can be divided into:

- (a) Mix Variance:** When more than one product is manufactured and sold, the difference in profit can result because of the variation of actual mix and budgeted mix of sales. The difference between revised standard profit and the standard profit, therefore is the mix variance. The formula is:

Mix Variance = Revised Standard Profit – Standard Profit



(b) **Quantity Variance:** It results from the variation in profit because of difference in actual quantities sold and the budgeted quantities both taken in the same ratio. The actual quantities are to be revised in the ratio of standard mixture. The formula is:

$$\text{Quantity Variance} = \text{Budgeted Profit} - \text{Revised Standard Profit}$$

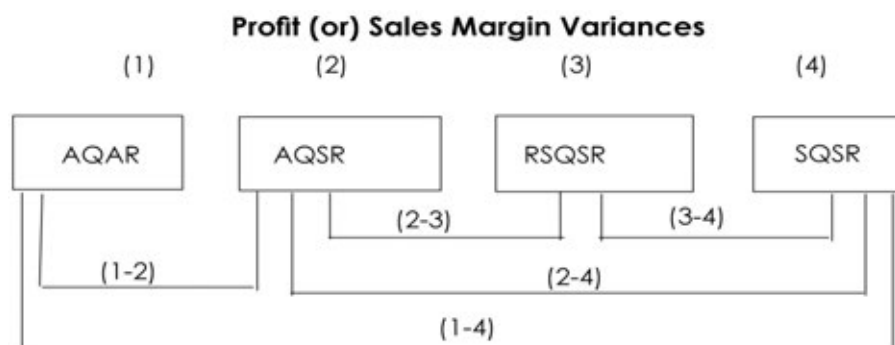

Where,

AQ = Actual Quantity Sold

AR = Actual Rate of Profit

SR (or) BR = Standard (or) Budgeted Rate of Profit

RSQ = Revised Standard Quantity

SQ (or) BQ = Standard (or) Budgeted Quantity

1. AQAR = Actual Profit
2. AQSR = Actual Quantity of Sales at Standard Rate of Profit
3. RSQSR = Revised Standard (or) Budgeted Profit
4. SQSR = Standard (or) Budgeted Profit
  - a. Profit Sub-Volume or Quantity Variance = 3-4
  - b. Profit Variance due to Sales Mix =  $\frac{2-3}{2}$
  - c. Profit Variance due to Sales Volume = 2-4
  - d. Profit Variance due to Selling Price =  $\frac{1-2}{1}$
  - e. Total Profit Variance = 1-4

### 4.3 INVESTIGATION OF VARIANCES & REPORTING OF VARIANCES

#### Reporting of Variances

In order that variance reporting should be effective, it is essential that the following *requisites* are fulfilled:

1. The variances arising out of each factor should be correctly segregated. If part of a variance due to one factor is wrongly attributed to or merged with that of another, the analysis report submitted to the management would be misleading and wrong conclusions may be drawn from it.
2. Variances, particularly the controllable variances should be reported with promptness as soon as they occur. Mere operation of Standard Costing and reporting of variances is of no avail. The success



of a Standard Costing system depends on the extent of responsibility which the management assumes in correcting the conditions which cause variances from standard. In order to assist the management in assuming this responsibility, the variances should be reported frequently and on time. This would enable corrective action being taken for future production while work is in progress and before the project or job is completed.

3. For effective control, the line of organisation should be properly defined and the authority and responsibility of each individual should be laid down in clear terms. This will avoid 'passing on the buck' and shirking of responsibility and will enable the tracing of the causes of variances to the appropriate levels of management.
4. In certain cases, a particular variance may be the joint responsibility of more than one individual or department. It is obvious that if corrective action has to be effective in such cases, it should be taken jointly.
5. Analysis of uncontrollable variances should be made with the same care as for controllable variances. Though a particular variance may not be controllable at the lower level of management, a detailed analysis of the off-standard situation may reveal far reaching effects on the economy of the concern. This should compel the top management to take corrective action, say, by changing the policy which gave rise to the uncontrollable variance.

### **Forms of Variance Reports**

The forms of reports for the different types of variances should be designed keeping in view the needs of the management and the size of the concern, and no standard forms are, therefore, suggested. Variance Analysis Reports prepared for the top management would obviously be more formal and would contain broad details only, while those meant for presentation to the lower levels would contain details showing the causes of each variance and the specific responsibilities of the individuals concerned.

### **Variance Ratios and Cost Ratios**

We have so far considered the various cost variances in absolute monetary terms. Although these show the extent of the variances, the information is insufficient if the management wants to study the trend of variances from period to period. Absolute figures in themselves do not give the full picture and it is only by comparison of one item with another that their correct relationship is obtained. Variance Ratios serve this need and comparison of these ratios from one period to another can be gainfully made. Another advantage of Variance Ratio is in regard to its applicability in the dual plan of standard cost accounting. With the help of the Cost Variance Ratios, standard costs of production and the standard values of inventory can be easily converted into actual costs for the purpose of incorporation in the financial accounts.

A number of ratios are used for reporting to the management the effective use of capacity, material, labour and other resources of a concern. Some of these are considered below:

1. Efficiency Ratio.
2. Activity Ratio.
3. Calendar Ratio.
4. Capacity usage Ratio
5. Capacity utilization Ratio.
6. Idle Time Ratio.



1. **Efficiency Ratio:** It is the standard hours equivalent to the work produced, expressed as a percentage of the actual hours spent in producing that work.

$$\text{Efficiency Ratio} = \frac{\text{Standard Hours}}{\text{Actual Hours}} \times 100$$

2. **Activity Ratio:** It is the number of standard hours equivalent to the work produced, expressed as a percentage of the budgeted standard hours.

$$\text{Activity Ratio} = \frac{\text{Standard Hours for Actual Work}}{\text{Budgeted Standard Hours}} \times 100$$

3. **Calendar Ratio:** It is the relationship between the number of working days in a period and the number of working days in the relative budget period.

$$\text{Calendar Ratio} = \frac{\text{Available Working Days}}{\text{Budgeted Working Days}} \times 100$$

4. **Capacity Usage Ratio:** It is the relationship between the budgeted number of working hours and the maximum possible number of working hours in a budget period.

$$\text{Capacity usage Ratio} = \frac{\text{Budgeted Hours}}{\text{Maximum Possible Hours in Budget Period}} \times 100$$

5. **Capacity Utilisation Ratio:** It is the relationship between actual hours in a budget period and the budgeted working hours in the period.

$$\text{Capacity utilisation Ratio} = \frac{\text{Actual Hours}}{\text{Budgeted Hours}} \times 100$$

6. **Idle Time ratio:** It is the ratio of idle time hours to the total hours budgeted.

$$\text{Idle Time Ratio} = \frac{\text{Ideal Time Hours}}{\text{Budgeted Hours}} \times 100$$

#### 4.4 VALUATION OF STOCK UNDER STANDARD COSTING

##### Stock Valuation

The function of a Balance Sheet is to give a true and fair view of the state of affairs of a company on a particular date. A true and fair view also implies the consistent application of generally accepted principles. Stocks valued at standard costs are required to be adjusted at actual costs in the following circumstances:

- a. As per Indian Accounting Standards - 2, closing stock to be valued either at cost price or at net realisable value (NRV) whichever is less.
- b. The standard costing system introduced is still in an experimental stage and the variances merely represent deviations from poorly set standards.



- c. Occurrence of certain variances which are beyond the control of the management. (unless the stocks are adjusted for uncontrollable factors, the values are not correctly stated).

### **Maintenance of Raw Material Stock at Standard Cost**

In the single plan, the inventory in the stores ledger may be carried either at standard costs or at actual. Although both the methods are in use, the consensus is in favour of standard costs. The advantages of adopting standard costs for inventory valuation are as follows:

- a. Stores ledger may be maintained in quantities only and the standard price noted at the top in the ledger sheets. This economises the use of forms as well as reduces clerical costs as no columns for rates need be maintained.
- b. Pricing of materials requisitions is simplified as only one standard price for each item of material is required to be used.
- c. Price variance is promptly revealed at the time of purchase of material.

The disadvantages are:

- a. The stores ledger does not reveal the current prices.
- b. If the material stock is shown in the Balance Sheet at standard costs, the variances have the effect of distorting the profit or loss. Standard cost of the closing inventory is required to be adjusted to actual cost based on price variance to comply with the statutory requirement of the Companies Act, 2013.
- c. A revision of the standard necessitates revision of the cost of the inventory.

## **4.5 UNIFORM COSTING AND INTER-FIRM COMPARISON**

### **Introduction**

Uniform Costing is not a separate method or type of Costing. It is a technique of Costing and can be applied to any industry. Uniform Costing may be defined as the application and use of the same costing principles and procedures by different organisations under the same management or on a common understanding between members of an association. The main feature of uniform costing is that whatever be the method of costing used, it is applied uniformly in a number of concerns in the same industry, or even in different but similar industries. This enables cost and accounting data of the member undertakings to be compiled on a comparable basis so that useful and crucial decisions can be taken. The principles and methods adopted for the accumulation, analysis, apportionment and allocation of costs vary so widely from concern to concern that comparison of costs is rendered difficult and unrealistic. Uniform Costing attempts to establish uniform methods so that comparison of performances in the various undertakings can be made to the common advantage of all the constituent units.

### **Scope of Uniform Costing**

Uniform Costing methods may be advantageously applied:

- a. In a single enterprise having a number of branches or units, each of which may be a separate manufacturing unit.
- b. In a number of concerns in the same industry bound together through a trade association or otherwise, and
- c. In industries which are similar in nature such as gas and electricity, various types of transport, and cotton, jute and woollen textiles.



The need for application of uniform Costing System exists in a business, irrespective of the circumstances and conditions prevailing therein. In concerns which are members of a trade association, the procedure for uniform Costing may be devised and controlled by the association or by any other central body specially formed for the purpose.

### **Requisites for Installation of a Uniform Costing System**

The organisational set up for implementing the principles and methods of uniform Costing may take different forms. It may range from a small association of a number of concerns who agree to have uniform information regarding a few specific cost accounting respects, to be a large organisation which has a fully developed scheme covering all the aspects of costing. The success of a uniform costing system will depend upon the following:

- a. There should be a spirit of mutual trust, co-operation and a policy of give and take amongst the participating members.
- b. There should be a free exchange of ideas and methods.
- c. The bigger units should be prepared to share with the smaller ones, improvements, achievements of efficiency, benefits of research and know-how.
- d. There should not be any hiding or withholding of information.
- e. There should be no rivalry or sense of jealousy amongst the members.

In the application of uniform Costing, the fundamental requirement is, therefore, to locate such differences and to eliminate or overcome, as far as practicable, the causes giving rise to such differences. The basic reasons for the differences may be as follows:

#### **a. Size and organisational set up of the business**

The number and size of the departments, sections and services also vary from one concern to another according to their size and organisation. The difficulty in operating uniform Cost Systems for concerns which vary widely in regard to size and type of business may to some extent be overcome by arranging the various units in a number of size or type ranges, and applying different uniform systems for each such type.

#### **b. Methods of production**

The use of different types of machines, plant and equipments, degree of mechanization, difference in materials mix and sequence and nature of operations and processes are mainly responsible for the difference in costs.

#### **c. Methods and principles of cost accounting applied**

It is in this sphere that the largest degree of difference arises. undertakings manufacturing identical or similar products and having the same system of cost accounting would generally employ different methods of treatment of expenditure on buying, storage and issue of materials, pricing of stores issues, payment to workers, basis of classification and absorption of overhead, calculation of depreciation, charging rent on freehold or leasehold assets etc.

### **Fields covered by Uniform Costing**

There is no system of uniform Costing which may be found to fit in all circumstances. The system to be installed should be tailored to meet the needs of each individual case. The essential points on which uniformity is normally required may be summarized as follows:

- a. Whether costs are required for the individual products i.e. for the cost units or for cost centres
- b. The method of costing to be applied
- c. The technique employed such as Standard Costing, Marginal Costing



- d. Items to be excluded from costs
- e. The basis of departmentalization
- f. The basis of allocation of costs to departments and/or service department costs to production departments
- g. The methods of application administration, selling and distribution overhead to cost of sales
- h. The method of valuation of work-in-progress
- i. Methods of treating cost of spoilage, defective work, scrap and wastage
- j. Methods of accounting of overtime pay bonus and other miscellaneous allowances paid to workers
- k. Whether purchase, material handling and upkeep expenses are added to the cost of stores or are treated as overhead expenses
- l. The system of materials control-pricing of issues and valuation of stock
- m. The system of classification and coding of accounts
- n. The method of recording accounting information

### **Advantages of Uniform Costing**

Main advantages of a uniform Costing System are summarised below:

- (i) It provides comparative information to the members of the organisation/association which may by them to reduce or eliminate the evil effects of competition and unnecessary expenses arising from competition.
- (ii) It enables the industry to submit the statutory bodies reliable and accurate data which might be required to regulate pricing policy or for other purposes.
- (iii) It enables the member concerns to compare their own cost data with that of the others detect the weakness and to take corrective steps for improvement in efficiency.
- (iv) The benefits of research and development can be passed on the smaller members of the association lead to economy of the industry as a whole.
- (v) It provides all valuable features of sound cost accounting such as valued and efficiency of the workers, machines, methods, etc., current reports of comparing major cost items with the predetermined standards, etc.
- (vi) It serves as a prerequisite to Cost Audit and inter firm comparison.
- (vii) Uniform Costing is a useful tool for management control. Performance of individual units can be measured against norms set for the industry as a whole.
- (viii) It avoids cut-throat completion by ensuring that competition among member units proceeds on healthy lines.
- (ix) The process of pricing policy becomes easier when uniform Costing is adopted.
- (x) By showing the one best way of doing things, uniform Costing creates cost consciousness and provides the best system of cost control and cost presentation in the entire industry.
- (xi) Uniform costing simplifies the work of wage boards set up to fix minimum wages and fair wages for an industry.

### **Limitations of Uniform Costing**

- (i) Uniform costing presumes the application of same principles and methods of Costing in each of the member firms. But individual units generally differ in respect of certain key factors and methods.



- (ii) For smaller units the cost of installation and operation of uniform Costing System may be more than the benefits derived by them.
- (iii) Uniform costing may create conditions that are likely to develop monopolistic tendencies within the industry. Prices may be raised artificially and supplies curtailed.
- (iv) If complete agreement between the members is not forthcoming, the statistics presented cannot be relied upon. This weakens the uniform Costing System and reduces its usefulness.

### **Inter Firm Comparison**

Inter-firm comparison as the name denotes means the techniques of evaluating the performances, efficiencies, deficiencies, costs and profits of similar nature of firms engaged in the same industry or business. It consists of exchange of information, voluntarily of course, concerning production, sales cost with various types of break-up, prices, profits, etc., among the firms who are interested or willing to make the device a success. The basic purposes of such comparison are to find out the work points in an organisation and to improve the efficiency by taking appropriate measures to wipe out the weakness gradually over a period of time.

The benefits which are derived from Inter-firm Comparison are appended below:

- a. Inter-firm Comparison makes the management of the organisation aware of strengths and weakness in relation to other organisations in same industry.
- b. As only the significant items are reported to the Management time and efforts are not unnecessary wasted.
- c. The management is able to keep up to data information of the trends and ratios and it becomes easier for them to take the necessary steps for improvement.
- d. It develops cost consciousness among the members of the industry.
- e. Information about the organisation is made available freely without the fear of disclosure of confidential data to outside market or public.
- f. Specialized knowledge and experience of professionally run and successful organisations are made available to smaller units who can take the advantages it may be possible for them to have such an infrastructure.
- g. The industry as a whole benefits from the process due to increased productivity, standardization of products, elimination of unfair comparison and the trade practices.
- h. Reliable and collective data enhance the organising power in deal in with various authorities and government bodies.
- i. Inter firm comparison assists in a big way in identifying industry sickness and gives a timely warning so that effective remedial steps can be taken to save the organisation.

### **Limitations of Inter-firm Comparison**

The practical difficulties that are likely to arise in the implementation of a scheme of inter-firm comparison are:

- a. The top management may not be convinced of the utility of inter-firm comparison.
- b. Reluctance to disclose data which a concern considers to be confidential.
- c. A sense of complacence on the part of the management who may be satisfied with the present level of profits.
- d. Absence of a proper system of Cost Accounting so that the costing figures supplied may not be relied upon for comparison purposes.
- e. Non-availability of a suitable base for comparison.





These difficulties may be overcome to a large extent by taking the following steps:

- 'Selling' the scheme through education and propaganda. Publication of articles in journals and periodicals, and lectures, seminars and personal discussions may prove useful.
- Installation of a system which ensures complete secrecy.
- Introduction of a scientific cost system.

### Illustration 1

The share of total production and the cost-based fair price computed separately for each of the four units in industry are as follows:

	(₹) per unit			
Share of Production	40%	25%	20%	15%
Material Costs	150	180	170	190
Direct Labour	100	120	140	160
Depreciation	300	200	160	100
Other overheads	300	300	280	240
	850	800	750	690
20% return on capital employed	628	430	350	230
Fair Price	1,480	1,230	1,100	920
Capital employed per unit is worked out as follows:				
Net Fixed Assets	3,000	2,000	1,600	1,000
Working Capital	140	150	150	150
Total	3,140	2,150	1,750	1,150

Indicate with reasons, what should be the uniform Price fixed for the product.

### Solution:

#### Computation of Uniform Price:

$$\begin{aligned}
 \text{Weighted Average Cost} &= [850 \times 40\%] + [800 \times 25\%] + [750 \times 20\%] + [690 \times 15\%] \\
 &= 340 + 200 + 150 + 103.5 \\
 &= ₹793.5
 \end{aligned}$$

$$\begin{aligned}
 \text{Weighted Average Return on Capital employed (profit)} &= [628 \times 40\%] + [430 \times 25\%] + [350 \times 20\%] + [230 \times 15\%] \\
 &= 251.20 + 107.5 + 70 + 34.5 \\
 &= ₹463.20
 \end{aligned}$$

$$\text{Uniform Price} = 793.5 + 463.20 = ₹1,256.70.$$

### Illustration 2

The standard costs of a certain chemical mixture is:

40% Material A at ₹200 per ton

60% Material B at ₹300 per ton



A standard loss of 10% is expected in production  
During a period they used  
90 tons of Material A at the cost of ₹ 180 per ton  
110 tons of Material B at the cost of ₹ 340 per ton  
The weight produced is 182 tons of good production.  
Calculate and present Material price, usage, Mix

**Solution:****Analysis of Given Data**

Material	Standard Data			Actual Data		
	Quantity	Price (₹)	Value (₹)	Quantity	Price (₹)	Value (₹)
A	80	200	16,000	90	180	16,200
B	120	300	36,000	110	340	37,400
	200		52,000	200		53,600
Less: Loss	20		-	18		-
	180		52,000	182		53,600

**Computation of Required Values**

Material	SQSP (1) (₹)	RSQSP (2) (₹)	AQSP (3) (₹)	AQAP (4) (₹)
A	80.88 x 200 = 16,176	16,000	90 x 200 = 18,000	16,200
B	121.33 x 300 = 36,400	36,000	110 x 300 = 33,000	37,400
	52,578	52,000	51,000	53,600

**Computation of SQ:**

$$SQ = \left( \frac{\text{RSQ for that product}}{\text{RSQ for all product}} \right) \times AQ \text{ for that product}$$

$$\text{For A} = \left( \frac{80}{180} \right) \times 182 \\ = 80.88 \text{ units}$$

$$\text{For B} = \left( \frac{120}{80} \right) \times 182 \\ = 121.33$$

Where

- (1) **SQSP** = Standard cost of Standard Material = ₹ 52,578
- (2) **RSQSP** = Revised Standard Cost of Material = ₹ 52,000
- (3) **AQSP** = Standard Cost of Actual Material = ₹ 51,000
- (4) **AQAP** = Actual Cost of Material = ₹ 53,600



### Computation of Required Variances

- Material yield Variance = (1) - (2) = ₹578 (F) [₹(52,578 - 52,000)]
- Material Mix Variance = (2) - (3) = ₹1,000 (F) [₹(52,000 - 51,000)]
- Material usage Variance = (1) - (3) = ₹1,578 (F) [₹(52,578 - 51,000)]
- Material Price Variance = (3) - (4) = ₹2,600 (A) [₹(51,000 - 53,600)]
- Material Cost Variance = (1) - (4) = ₹1,022 (A) [₹(52,578 - 53,600)]

### Illustration 3

SV Ltd., manufactures BXE by mixing 3 raw materials. For every batch of 100 kg. of BXE, 125 kg of raw materials are used. In April 2012, 60 batches were prepared to produce an output of 5600 kg of BXE. The standard and actual particulars for April, 2012 are as under:

Raw material	Standard Mix %	Price per kg (₹)	Actual Mix %	Price per kg (₹)	Quantity of raw materials purchased (Unit)
A	50	20	60	21	5000
B	30	10	20	8	2000
C	20	5	20	6	1000

Calculate all variances.

**Solution:**

#### Analysis of Given Data

Material	Standard Data			Actual Data		
	Quantity	Price (₹)	Value (₹)	Quantity	Price (₹)	Value (₹)
A	3,750	20	75,000	4,500	21	94,500
B	2,250	10	22,500	1,500	8	12,000
C	1,500	5	7,500	1,500	6	9,000
	7,500		1,05,000	7,500		1,15,500
<b>Less: Loss</b>	1,500		-	1,900		-
	<b>6,000</b>		<b>1,05,000</b>	<b>5,600</b>		<b>1,15,500</b>

#### Computation of Required Values

Material	SQSP (1) (₹)	RSQSP (2) (₹)	AQSP (3) (₹)	AQAP (4) (₹)
A	75,000	3,500 x 20 = 70,000	4,500 x 20 = 90,000	94,500
B	22,500	2,100 x 10 = 21,000	1,500 x 10 = 15,000	12,000
C	7,500	1,400 x 5 = 7,000	1,500 x 5 = 7,500	9,000
	1,05,000	98,000	1,12,500	1,15,500

**Computation of SQ**

$$SQ = \left( \frac{RSQ \text{ for that product}}{RSQ \text{ for all product}} \right) \times AQ \text{ for that product}$$

$$\text{For A} = \left( \frac{3,750}{6,000} \right) \times 5,600 = 3,500 \text{ units}$$

$$\text{For B} = \left( \frac{2,250}{6,000} \right) \times 5,600 = 2,100 \text{ units}$$

$$\text{For C} = \left( \frac{1,500}{6,000} \right) \times 5,600 = 1,400 \text{ units.}$$

Where

- (1) **SQSP** = Standard Cost of Standard Material = ₹ 98,000
- (2) **RSQSP** = Revised Standard Cost of Material = ₹ 1,05,000
- (3) **AQSP** = standard Cost of Actual Material = ₹ 1,12,500
- (4) **AQAP** = Actual Cost of Material = ₹ 1,15,500.

**Computation of Required Variances**

- (a) Material yield Variance = (1) – (2) = ₹ 7,000 (A) [₹(98,000 – 1,05,000)]
- (b) Material Mix Variance = (2) – (3) = ₹ 7,500 (A) [₹(1,05,000 – 1,12,500)]
- (c) Material usage Variance = (1) – (3) = ₹ 14,500 (A) [₹(98,000 – 1,12,500)]
- (d) Material Price Variance = (3) – (4) = ₹3,000 (A) [₹(1,12,500 – 1,15,500)]
- (e) Material Cost Variance = (1) – (4) = ₹17,500 (A) [₹(98,000 – 1,15,500)]

**Illustration 4**

A brass foundry making castings which are transferred to the machine shop of the company at standard price uses a standard costing system. Basing standards in regard to material stocks which are kept at standard price are as follows

Standard Mixture:	70% Copper and 30% Zinc
Standard Price:	Copper ₹ 2,400 per ton and Zinc ₹ 650 per ton
Standard loss in melt:	5% of input
Figures in respect of a costing period are as follows:	
Commencing stocks:	Copper 100 tons Zinc 60 tons
Finished stock:	Copper 110 tons Zinc 50 tons
Purchases:	Copper 300 tons cost ₹ 7,32,500 Zinc 60 tons cost ₹ 62,500



Metal melted 400 tons

Casting produced 375 tons

Present figures showing: Material price, Mixture and yield  
Variance

### Solution:

#### Computation of Actual Quantity (AQ)

Particulars	Copper		Zinc	
	Quantity (tons)	Value (₹)	Quantity (tons)	Value (₹)
opening Stock	100	2,40,000	60	39,000
<b>Add:</b> Purchases	300	7,32,500	100	62,500
	400	9,72,500	160	1,01,500
<b>Less:</b> Closing stock	110	2,64,000	50	32,500
AQ	290	7,08,500	110	69,000

#### Analysis of Given Data

Material	Standard Data			Actual Data		
	Quantity (tons)	Price (₹)	Value (₹)	Quantity (tons)	Price (₹)	Value (₹)
Copper	280	2,400	6,72,000	290		7,08,500
Zinc	120	650	78,000	110		69,000
	400		7,50,000	400		7,77,500
<b>Less:</b> Loss @ 5%	20		-	25		-
	380		7,50,000	375		7,77,500

#### Computation of Required Values

Material	SQSP (1)	RSQSP (2)	AQAP (4)	AQSP (3)
Copper	276.31 x 2,400 = 6,63,157.87	6,72,000	290 x 2,400 = 6,96,000	7,08,500
Zinc	118.42 x 650 = 76,973.68	78,000	110 x 650 = 71,500	69,000
Total	7,40,132	7,50,000	7,67,500	7,77,500

#### Computation of SQ

$$SQ = \left( \frac{\text{RSQ for that material}}{\text{RSQ for all material}} \right) \times \text{AQ for that material}$$

$$\text{For Copper} = \left( \frac{280}{380} \right) \times 375 = 276.31 \text{ units.}$$

$$\text{For Zinc} = \left( \frac{120}{380} \right) \times 375 = 118.42 \text{ units.}$$



Where

- (1) SQSP = Standard Cost of Standard Material = ₹ 7,40,132
- (2) RSQSP = Revised Standard Cost of Material = ₹ 7,50,000
- (3) AQSP = standard Cost of Actual Material = ₹ 7,67,500
- (4) AQAP = Actual Cost of Material = ₹ 7,77,500.

**Computation of Required Variances:**

- a. Material yield Variance = (1) - (2) = ₹9,868 (A) [₹(7,40,132 - 7,50,000)]
- b. Material Mix Variance = (2) - (3) = ₹17,500 (A) [₹(7,50,000 - 7,67,500)]
- c. Material usage Variance = (1) - (3) = ₹27,368 (A) [₹(7,40,132 - 7,67,500)]
- d. Material Price Variance = (3) - (4) = ₹10,000 (A) [₹(7,67,500 - 7,77,500)]
- e. Material Cost Variance = (1) - (4) = ₹37,368 (A) [₹(7,40,132 - 7,77,500)]

**Illustration 5**

A company manufacturing a special type of fencing tile 12"X 8" X 1\2" used a system of standard costing. The standard mix of the compound used for making the tiles is:

1,200 kg. of Material A @ ₹0.30 per kg.

500 kg. of Material B @ ₹0.60 per kg.

800 kg. of Material C @ ₹0.70 per kg.

The compound should produce 12,000 square feet of tiles of 1/2" thickness. During a period in which 1,00,000 tiles of the standard size were produced, the material usage was:

Kg		(₹)
7,000	Material A @ ₹ 0.32 per kg.	2,240
3,000	Material B @ ₹ 0.65 per kg.	1,950
5,000	Material C @ ₹ 0.75 per kg.	3,750
15,000		7,940

Present the cost figures for the period showing Material Price, Mixture, Sub-usage Variance.

**Solution:**

Area of tile = 12 x 8/12 x 12 = 2/3 sq. ft.

No of tiles that can be laid in 12,000 sq. ft. is 12,000 / (2/3) = 18,000 tiles.

	Standard Data			Actual Data		
	Q	P (₹)	V (₹)	Q	P (₹)	V (₹)
A	6,666.67	0.3	2,000	7,000	0.32	2,240
B	2,777.77	0.6	1,666.67	3,000	0.65	1,950
C	4,444.44	0.7	3,111.11	5,000	0.75	3,750
	13,888.89		6,778	15,000		7,940



	(1)	(2)	(3)	(4)
	SQSP (₹)	RSQSP (₹)	AQSP (₹)	AQAP (₹)
A	2,000	7,200 × 0.3	7,000 × 0.3	2,240
B	1,666.67	3,000 × 0.6	3,000 × 0.6	1,950
C	3,111.11	4,800 × 0.7	5,000 × 0.7	3,750
A		2,160	2,100	
B		1,800	1,800	
C		3,360	3,500	
	(₹) 6,778	(₹) 7,320	(₹) 7,400	(₹) 7,940

RSQ for A =  $(15,000/13,888.89) \times 6,666.67 = 7,200$  units.

1. **SQSP** = Standard Cost of Standard Material = ₹ 6,778
2. **RSQSP** = Revised Standard Cost of Material = ₹ 7,320
3. **AQSP** = Standard Cost of Actual Material = ₹ 7,400
4. **AQAP** = Actual Cost of Material = ₹ 7,940
  - a. Material Sub-usage Variance =  $(1 - 2) = ₹ 542(A)$
  - b. Material Mix Variance =  $(2 - 3) = ₹ 80(A)$
  - c. Material usage Variance =  $(1 - 3) = ₹ 622(A)$
  - d. Material Price Variance =  $(3 - 4) = ₹ 540(A)$
  - e. Material Cost Variance =  $(1 - 4) = ₹ 1,162(A)$

#### Illustration 6

The standard mix of product M5 is as follows:

LBs	Material Price Per LB
50% A	5.00
20% B	4.00
30% C	10.00

Standard loss is 10% of input. There is no scrap value. Actual production for month was LB.7240 of M5 from 80 mixes. Purchases and consumption is as follows:

LBs Material	Price
4160 A	5.5
1680 B	3.75
2560 C	9.5

Calculate variances.

**Solution:****Analysis of Given Data**

Material	Standard Data			Actual Data		
	Quantity	Price	Value	Quantity	Price	Value
A	4,200	5	21,000	4,160	5.50	22,880
B	1,680	4	6,720	1,680	3.75	6,300
C	2,520	10	25,200	2,560	9.50	24,320
	8,400		52,920	8,400		53,500
<b>Less: Loss</b>	840		-	1,160		-
	7,560		52,920	7,240		53,500

**Computation of Required Values**

Material	SQSP (1) (₹)	RSQSP (2) (₹)	AQSP (3) (₹)	AQAP (4) (₹)
A	$4,022.22 \times 5 = 20,111.11$	21,000	$4,160 \times 5 = 20,800$	22,880
B	$1,608.889 \times 4 = 6,435.56$	6,700	$1,680 \times 4 = 6,720$	6,300
C	$2,413.33 \times 10 = 24,133.33$	25,200	$2,560 \times 10 = 25,600$	24,320
	50,680	52,920	53,120	53,500

**Computation of SQ:**

$$SQ = \left( \frac{\text{SQ for that material}}{\text{SQ for all material}} \right) \times \text{AQ for that material}$$

$$\text{For A} = \left( \frac{4,200}{7,560} \right) \times 7,240 = 4,022.22$$

$$\text{For B} = \left( \frac{1,680}{7,560} \right) \times 7,240 = 1,608.889$$

$$\text{For C} = \left( \frac{2,520}{7,560} \right) \times 7,240 = 2,413.33$$

Where

(1) SQSP = Standard Cost of Standard Material = ₹ 50,680

(2) RSQSP = Revised Standard Cost of Material = ₹ 52,920

(3) AQSP = Standard Cost of Actual Material = ₹ 53,120

(4) AQAP = Actual Cost of Material = ₹ 53,500.

**Computation Of Required Variances:**

a. Material yield variance = (1) – (2) = ₹ 2,240(A)

b. Material Mix Variance = (2) – (3) = ₹ 200(A)





- c. Material usage Variance = (1) – (3) = ₹ 2,440(A)  
 d. Material Price Variance = (3) – (4) = ₹ 380(A)  
 e. Material Cost Variance = (1) – (4) = ₹ 2,820(A)

### Illustration 7

The standard set for material consumption was 100kg. @ ₹ 2.25 per kg.

In a cost period:

Opening stock was 100 kg. @ ₹ 2.25 per kg.

Purchases made 500 kg. @ ₹ 2.15 per kg.

Consumption 110 kg.

**Calculate:** (a) usage (b) Price variance

- 1) When variance is calculated at point of purchase
- 2) When variance is calculated at point of issue on FIFO basis
- 3) When variance is calculated at point of issue on LIFO basis

**Solution:**

#### (a) Computation of Material Usage Variance

$$\begin{aligned}
 \text{Material usage Variance} &= \text{SQSP} - \text{AQSP} \\
 &= \text{SP} (\text{SQ} - \text{AQ}) \\
 &= 2.25(100-110) \\
 &= 22.50 \text{ (A)}
 \end{aligned}$$

#### (b) Computation of Price variance

##### 1) When Variance is calculated at the point of purchase

$$\begin{aligned}
 \text{Price variance} &= \text{AQSP} - \text{AQAP} \\
 &= (110 \times 2.25) - (110 \times 2.15) \\
 &= 11 \text{ (F)}
 \end{aligned}$$

##### 2) When variance is calculated at the point of issue on FIFO basis

$$\begin{aligned}
 \text{Price variance} &= \text{AQSP} - \text{AQAP} \\
 &= (110 \times 2.25) - ([100 \times 2.25] + [10 \times 2.15]) \\
 &= 1 \text{ (F)}
 \end{aligned}$$

##### 3) When variance is calculated at the point of issue on LIFO basis

$$\begin{aligned}
 \text{Price variance} &= \text{AQSP} - \text{AQAP} \\
 &= (110 \times 2.25) - (110 \times 2.15) \\
 &= 247.50 - 236.50 \\
 &= 11 \text{ (F)}
 \end{aligned}$$

**Illustration 8**

The standard labour complement and the actual labour complement engaged in a week for a job are as under:

	Skilled workers	Semi- skilled workers	Unskilled workers
a) Standard no. of workers in the gang	32	12	6
b) Standard wage rate per hour (₹)	3	2	1
c) Actual no. of workers employed in the gang during the week	28	18	4
d) Actual wage rate per hour (₹)	4	3	2

During the 40 hour working week the gang produced 1,800 standard labour hours of work. Calculate

- 1) Labour efficiency Variance
- 2) Mix Variance
- 3) Rate of Wages Variance
- 4) Labour Cost Variance

**Solution:****Analysis of Given Data**

	Standard Data			Actual Data		
	Hours	Rate (₹)	Value (₹)	Hours	Rate (₹)	Value (₹)
Skilled	1,280	3	3,840	1,120	4	4,480
Semi skilled	480	2	960	720	3	2,160
unskilled	240	1	240	160	2	320
	2,000		5,040	2,000		6,960

**Computation of Required Values**

	SRSB (1) (₹)	SRRSH (2) (₹)	SRAH (3) (₹)	ARAH (4) (₹)
Men	3 x 1,152 = 3,456	3,840	3 x 1,120 = 3,360	4,480
Women	2 x 432 = 864	960	2 x 720 = 1,440	2,160
Boys	1 x 216 = 216	240	1 x 160 = 160	320
	4,536	5040	4,960	6,960

**Computation of SH**

$$SH = \left( \frac{\text{SH for that worker}}{\text{SH for all the worker}} \right) \times AQ \text{ for that worker}$$

$$\text{For Skilled worker} = \left( \frac{1,280}{2,000} \right) \times 1,800 = 1,152$$

$$\text{For Semiskilled worker} = \left( \frac{480}{2,000} \right) \times 1,800 = 432$$

$$\text{For unskilled worker} = \left( \frac{240}{2,000} \right) \times 1,800 = 216$$



Where

- (1) SRSH = Standard Cost of Standard Labour = ₹ 4,536
- (2) SRRSH = Revised Standard Cost of Labour = ₹ 5,040
- (3) SRAH = Standard Cost of Actual Labour = ₹ 4,960
- (4) ARAH = Actual Cost of Labour = ₹ 6,960

#### Computation of Labour Variances:

- a. Labour Sub-efficiency Variance = (1) – (2) = ₹ 504 (A) [₹(4,536 – 5,040)]
- b. Labour Mix or gang Variance = (2) – (3) = ₹80 (F) [₹(5,040 – 4,960)]
- c. Labour efficiency Variance = (1) – (3) = ₹424 (A) [₹(4,536 – 4,960)]
- d. Labour Rate Variance = (3) – (4) = ₹2,000 (A) [₹(4,960 – 6,960)]
- e. Labour Cost Variance = (1) – (4) = ₹2,424 (A) [₹(4,536 – 6,960)]

#### Illustration 9

Calculate variances from the following:

STANDARD				ACTUAL			
INPUT	MATERIAL	(₹)/KG	TOTAL	INPUT	MATERIAL	(₹)/KG	TOTAL
400	A	@ 50	20,000	420	A	@ 45	18,900
200	B	@20	4,000	240	B	@ 25	6,000
100	C	@15	1,500	90	C	@15	1,350
700			25,500	750			26,250
	LABOUR HOURS				LABOUR HOURS		
	100 @ ₹ 2 per hour	200			120 @ ₹ 2.50 per hour	300	
	200 woman @ ₹1.50	300	500		240 woman @ ₹ 1.60	384	684
25	Normal Loss			75	Actual Loss		
675			26,000	675			26,934

**Solution:**

**Calculation of Material Variances:**

	(1)	(2)	(3)	(4)
	SQSP (₹)	RSQSP (₹)	AQSP (₹)	AQAP (₹)
A		428.57 x 50	420 x 50	
B		214.29 x 20	240 x 20	
C		107.14 x 15	90 x 15	
A	20,000	21,429	21,000	18,900
B	4,000	4,289	4,800	6,000
C	1,500	1,607	1,350	1,350
	₹ 25,500	₹ 27,325	₹ 27,150	₹ 26,250



RSQ for

$$A = 400/700 \times 750 = 428.67 \text{ units}$$

$$B = 200/700 \times 750 = 214.29 \text{ units}$$

$$C = 100/700 \times 750 = 107.14 \text{ units}$$

1. SQSP = Standard Cost of Standard Material = ₹ 25,500
2. RSQSP = Revised Standard Cost of Material = ₹ 27,325
3. AQSP = Standard Cost of Actual Material = ₹ 27,150
4. AQAP = Actual Cost of Material = ₹ 26,250
  - a. Material yield Variance (1-2) = ₹ 1,825 (A)
  - b. Material Mix Variance (2-3) = ₹ 175 (F)
  - c. Material usage Variance (1-3) = ₹ 1,650 (A)
  - d. Material Price Variance (3-4) = ₹ 900 (F)
  - e. Material Cost Variance (1-4) = ₹ 750 (A)

#### Calculation of Labour Variances:

	(1)	(2)	(3)
	<b>SRS</b> (₹)	<b>SRRS</b> (₹)	<b>SRAH</b> (₹)
Men		2 x 107.14	2 x 120
Women		1.50 x 214.28	1.50 x 240
Men	200	214.28	240
Women	300	321.42	360
	₹ 500	₹ 536	₹ 600

RSH for

$$\text{Men} = 100/700 \times 750 = 107.14 \text{ units.}$$

$$\text{Women} = 200/700 \times 750 = 214.28 \text{ units.}$$

1. SRS = Standard Cost of Standard Labour = ₹ 500
2. SRRS = Revised Standard Cost of Labour = ₹ 536
3. SRAH = Standard Cost of Actual Labour = ₹ 600
4. ARAH = Actual Cost of Labour = ₹ 684
  - a. Labour yield Variance (1-2) = ₹ 36 (A)
  - b. Labour Mix Variance (2-3) = ₹ 64 (A)
  - c. Labour efficiency Variance (1-3) = ₹ 100 (A)
  - d. Labour Rate Variance (3-4) = ₹ 84 (A)
  - e. Labour Cost Variance (1-4) = ₹ 184 (A)

**Illustration 10**

Budgeted hours for month of March, 2012	180 Hrs.
Standard rate of article produced per hour	50 Units
Budgeted fixed overheads	₹ 2,700
Actual production March, 2012	9,200 Units
Actual hours for production	175 Hrs.
Actual fixed overheads	₹ 2,800

Calculate overhead cost, budgeted variances.

**Solution:****Computation of Required Values**

SRSH (1) (₹)	SRAH (2) (₹)	SRBH (3) (₹)	ARAH (4) (₹)
15 x 184	15 x 175		
<b>2,760</b>	<b>2,625</b>	<b>2,700</b>	<b>2,800</b>

$$SR = \left( \frac{\text{Budgeted Fixed Overheads}}{\text{Budgeted Hours}} \right) = \left( \frac{2,700}{180} \right) = ₹ 15$$

Actual quantity = 9,200 units

$$\text{Standard Hours for Actual Production} = \left( \frac{9,200}{50} \right) = 184 \text{ hours}$$

Where

- (1) SRSH = Standard Cost of Standard Fixed overheads = ₹ 2,760
- (2) SRAH = Standard Cost of Actual Fixed overheads = ₹ 2,625
- (3) SRBH = Budgeted Fixed overheads = ₹ 2,700
- (4) ARAH = Actual Fixed overheads = ₹ 2,800

**Computation of Fixed Overhead Variances:**

- a. Fixed overheads efficiency Variance = (1) – (2) = ₹135(F)
- b. Fixed overhead capacity Variance = (2) – (3) = ₹75 (A)
- c. Fixed overhead Volume Variance = (1) – (3) = ₹60 (F)
- d. Fixed overhead Budget/ expenditure Variance = (3) – (4) = ₹100 (A)
- e. Fixed overhead Cost Variance = (1) – (4) = ₹ 40 (A)

**Illustration 11**

In Dept. A the following data is submitted for the week ended 31st October:

Standard output for 40 hours per week	1,400 units
Standard fixed overhead	₹ 1,400



Actual output 1,200 Units  
Actual fixed overhead ₹ 1,500  
Actual hours worked 32 Hours  
Prepare a statement of variances

**Solution:****Computation of Required Values**

SRSH (1) (₹)	SRAH (2) (₹)	SRBH (3) (₹)	ARAH (4) (₹)
$35 \times \left(\frac{9,200}{50}\right)$	$35 \times 32$		
1,200	1,120	1,400	1,500

$$SR = \left(\frac{\text{Budgeted Fixed Overheads}}{\text{Budgeted Hours}}\right) = \left(\frac{1,400}{40}\right) = 35 \text{ units.}$$

$$SH = \left(\frac{1,200}{35}\right) = 34.29 \text{ hrs. (approx.)}$$

Where

- (1) SRSH = Standard Cost of Standard Fixed overheads = 1,200
- (2) SRAH = Standard Cost of Actual Fixed overheads = 1,120
- (3) SRBH = Budgeted Fixed overheads = 1,400
- (4) ARAH = Actual Fixed overheads = 1,500.

**Computation of Fixed Overhead Variances**

- a. Fixed overheads efficiency Variance = (1) – (2) = ₹ 80 (F)
- b. Fixed overhead Capacity Variance = (2) – (3) = ₹ 280 (A)
- c. Fixed overhead Volume Variance = (1) – (3) = ₹200 (A)
- d. Fixed overhead Budget / expenditure Variance = (3) – (4) = ₹100 (A)
- e. Fixed overhead Cost variance = (1) – (4) = ₹300 (A)

**Illustration 12**

Item	Budget	Actual
No .of working days	20	22
Output per man hour	1.0 units	0.9 units
Overhead Cost (₹)	1,60,000	1,68,000
Man-hours per day	8,000	8,400

Calculate overhead Variances.

**Solution:**

(1) SRSH (₹)	(2) SRAH (₹)	(3) SRRBH (₹)	(4) SRBH (₹)	(5) ARAH (₹)
1 x 166320 = ₹ 166320	1 x 184800 = ₹ 184800	1 x 176000 = ₹ 176000	₹ 160000	₹ 168000

**Working Notes:**

SR = budgeted FOH/budgeted hours = 1,60,000/1,60,000 = 1

RBH = (22/20) x 1,60,000 = 1,76,000

AH = 22 x 8,400 = 1,84,800

AQ = 1,84,800 x 0.9 = 1,66,320

SH = 1,66,320/1 = 1,66,320

1. SRSH = Standard Cost of Standard Fixed overheads = ₹ 1,66,320

2. SRAH = Standard Cost of Actual Fixed overheads (or)

Fixed overheads Absorbed or Recovered = ₹ 1,84,800

3. SRRBH = Revised Budgeted Fixed overheads = ₹ 1,76,000

4. SRBH = Budgeted Fixed overheads = ₹ 1,60,000

5. ARAH = Actual Fixed overheads = ₹ 1,68,000

a. FOH efficiency Variance = 1-2 = ₹ 18,480(A)

b. FOH Capacity Variance = 2-3 = ₹ 8,800(F)

c. FOH Calendar Variance = 3-4 = ₹ 16,000(F)

d. FOH Volume Variance = 1-4 = ₹ 6,320(F)

e. FOH Budget Variance = 4-5 = ₹ 8,000(A)

f. FOH Cost Variance = 1-5 = ₹ 1,680(A)

**Illustration 13**

A manufacturing co. operates a costing system and showed the following data in respect of the month of November.

Actual no. of working days	22
Actual man hours worked during the month	4,300
No. of Products Produced	425
Actual overhead incurred	₹ 1,800

Relevant information from the company's budget and standard cost data is as follows:

Budgeted no. of working days per month	20
Budgeted man hours per month	4,000
Standard man hours per product	10
Standard overhead rate per month per hour	50 p.

you are required to calculate the overhead variances for the month of November



**Solution:**

**COMPUTATION OF REQUIRED VALUES**

SRSH (1) (₹)	SRAH (2) (₹)	SRRBH (3) (₹)	SRBH (4) (₹)	ARAH (5) (₹)
$0.5 \times 4,250$	$0.5 \times 4,300$	$0.5 \times 4,400$	$0.5 \times 4,000$	
2,125	2,150	2,200	2,000	1,800

$$SR = \left( \frac{\text{Budgeted Fixed Overheads}}{\text{Budgeted Hours}} \right) = \left( \frac{2,000}{4,000} \right) = 0.50$$

$$RBH = \left( \frac{22}{20} \times 4,000 \right) = ₹ 4,400$$

$$SH = 425 \times 10 = 4,250$$

Where

- (1) SRSH = Standard Cost of Standard Fixed overhead = ₹ 2,125
- (2) SRAH = Standard Cost of Actual overhead = ₹ 2,150
- (3) SRRBH = Revised Budgeted overheads = ₹ 2,200
- (4) SRBH = Budgeted overheads = ₹ 2,000
- (5) ARAH = Actual overheads = ₹ 1,800

**Computation of Required Variances**

- a. FOH efficiency Variance = (1) – (2) = ₹ 25 (A)
- b. FOH Capacity Variance = (2) – (3) = ₹ 50 (A)
- c. FOH Calendar Variance = (3) – (4) = ₹ 200 (F)
- d. FOH Volume Variance = (1) – (4) = ₹ 125 (F)
- e. FOH Budget Variance = (4) – (5) = ₹ 200 (F)
- f. FOH Cost Variance = (1) – (5) = ₹ 325 (F)

**Illustration 14**

SV Ltd has furnished you the following data:

	Budgeted	Actual
No. of working days	25	27
Production in units	20,000	22,000
Fixed overheads (₹)	30,000	31,000

Budgeted fixed OH rate is ₹1 per hour. In July, 2012 the actual hours worked were 31,500/hrs

Calculate the following variances:

- 1) Efficiency      2) Capacity      3) Calendar
- 4) Volume      5) expenditure      6) Total OH



**Solution:****Computation of Required Values**

SRSH (1) (₹)	SRAH (2) (₹)	SRRBH (3) (₹)	SRBH (4) (₹)	ARAH (5) (₹)
1 × 33,000	1 × 31,500	1 × 32,400		
33,000	31,500	32,400	30,000	31,000

$$RBH = 30,000 \times \frac{27}{25} = 32,400 \text{ 25}$$

$$\text{Standard time per unit} = \frac{30,000 \text{ hrs}}{20,000} = 1.5 \text{ hours}$$

$$SH = 22,000 \times 1.5 = 33,000$$

**Using unit rate:**

SRAQ (1) (₹)	SRSQ (2) (₹)	SRRBQ (3) (₹)	SRBQ (4) (₹)	ARAQ (5) (₹)
1.5 × 22,000	1.5 × 21,000	1.5 × 21,600	1.5 × 20,000	
33,000	31,500	32,400	30,000	31,000

$$SR = \frac{\text{BFOH's}}{\text{Budgeted Quantity}} = \frac{30,000}{20,000} = 1.5 \text{ hours}$$

$$RBQ = 20,000 \times \frac{27}{25} = 21,600$$

$$\text{Units in one hour} = \frac{20,000}{30,000} \text{ units}$$

$$SQ = 31,500 \times \frac{2}{3} = 21,000$$

1. SRSH / SRAQ Standard Cost of Standard FOH's = ₹ 33,000
2. SRAH / SRSQ – Standard Cost of Actual FOH's = ₹ 31,500
3. SRRBH/ SRRBQ – Revised Budgeted FOH's = ₹ 32,400
4. SRBH / SRBQ – Standard Fixed overheads = ₹ 30,000
5. ARAH/ARAQ – Actual Fixed overheads = ₹ 31,000
  - a. FOH efficiency Variance = (1) – (2) = 1,500 (F)
  - b. FOH Capacity Variance = (2) – (3) = 900 (A)
  - c. FOH Calendar Variance = (3) – (4) = 2,400 (F)
  - d. FOH Volume Variance = (1) – (4) = 3,000 (F)
  - e. FOH Budget or expensive Variance = (4) – (5) = 1,000 (A)
  - f. FOH Cost Variance = (1) – (5) = 2,000 (F)

**Illustration 15**

A Co. manufacturing two products operates a standard costing system. The standard OH content of each product in cost center 101 is

Product A ₹ 2.40 (8 direct labour hours @ 30 p. per hour)

Product B ₹ 1.80 (6 direct labour hours @ 30 p. per hour)

The rate of 30 p. per hour is arrived at as follows:

Budgeted OH ₹ 570

Budgeted Direct labour Hours ₹1,900

Output of product A 100 units

Output of product B 200 units

No opening or closing stock

Actual direct labour hours worked 2,320

Actual OH incurred ₹ 640

(a) you are required to calculate total OH for the month of October

(b) Show division into: 1) expenditure 2) Volume 3) efficiency Variances.

**Solution:****Computation of Required Values**

<b>SRSH (1) (₹)</b>	<b>SRAH (2) (₹)</b>	<b>SRBH (3) (₹)</b>	<b>ARAH (4) (₹)</b>
$0.3 \times 2000$	$0.3 \times 2320$	$0.3 \times 1,900$	
600	696	570	640

$$SH = (100 \times 8) + (200 \times 6) = 2000 \text{ hrs}$$

Where

(1) SRSH = Standard Cost of Standard Fixed overhead = ₹ 600

(2) SRAH = Standard Cost of Actual overhead = ₹ 696

(3) SRBH = Budgeted overheads = ₹ 570

(4) ARAH = Actual overheads = ₹ 640

**Computation of Required Variances:**

a. FOH efficiency Variance = (1) – (2) = 96 (A)

b. FOH Capacity Variance = (2) – (3) = 126 (F)

c. FOH Volume Variance = (1) – (3) = 30 (F)

d. FOH Budget Variance = (3) – (4) = 70 (A)

e. FOH Cost Variance = (1) – (4) = 40 (A)

**Illustration 16**

The following information was obtained from the records of a manufacturing unit using standard costing system.

Units	Standard	Actual
	4,000	3,800
No. of working days	20	21
Fixed overheads (₹)	40,000	39,000
Variable overhead (₹)	12,000	12,000

You are required to calculate the following overhead variances

1) Variable OH    2) Fixed    3) a) expenditure b) Volume c) Efficiency d) Calendar.

Also prepare a reconciliation statement for the standard fixed expenses worked out at standard fixed OH rate and actual OH.

**Solution:****Computation of Required Values**

<b>SRAQ (1) (₹)</b>	<b>SRRBQ (2) (₹)</b>	<b>SRBQ (3) (₹)</b>	<b>ARAQ (4) (₹)</b>
10 x 3800	10 x 4200	10 x 4000	
38000	42000	40000	39000

$$SR = \left( \frac{\text{Budgeted Fixed Overheads}}{\text{Budgeted Units}} \right) = \frac{30,000}{20,000} = 1.5 \text{ hours}$$

$$RBQ = \frac{21}{20} \times 4,000 = ₹ 4,200$$

Where

(1) SRAQ = Standard Cost of Standard Fixed overhead = ₹ 38,000

(2) SRRBQ = Revised Budgeted overheads = ₹ 42,000

(3) SRBQ = Budgeted overheads = ₹ 40,000

(4) ARAQ = Actual overheads = ₹ 39,000

**Computation of Required Variances**

a. FOH efficiency Variance = (1) – (2) = 4,000 (A)

b. FOH Calendar Variance = (2) – (3) = 2,000 (F)

c. FOH Volume Variance = (1) – (3) = 2,000 (A)

d. FOH Budget Variance = (3) – (4) = 1,000 (F)

e. FOH Cost Variance = (1) – (4) = 1,000 (A)

**Variable Overhead Variance = SRAQ – ARAQ**

$$= (3 \times 3,800) - 12,000$$

$$= 11,400 - 12,000$$

$$= ₹ 600 (A)$$

$$SR = \left( \frac{\text{Budgeted Variable Overheads}}{\text{Budgeted Hours}} \right) = \frac{12,000}{4,000} = ₹ 3 \text{ per hour.}$$

**Illustration 17**

Vinayak Ltd. has furnished you the following information for the month of August, 2012.

	Budget	Actual
Output (units)	30,000	32,500
Hours	30,000	33,000
Fixed OH (₹)	45,000	50,000
Variable OH (₹)	60,000	68,000
Working days	25	26

Calculate Variances.

**Solution:****Computation of Required Values**

(1) SRSH (₹)	(2) SRAH (₹)	(3) SRRBH (₹)	(4) SRBH (₹)	(5) ARAH (₹)
$1.5 \times 32,500$	$1.5 \times 33,000$	$1.5 \times 31,200$		
48,750	49,500	46,800	45,000	50,000

$$SR = \left( \frac{\text{Budgeted Variable Overheads}}{\text{Budgeted Hours}} \right) = \frac{45,000}{30,000} = ₹ 1.50$$

$$RBH = \left( \frac{26}{25} \times 30,000 \right) = ₹ 31,200$$

Where

(1) SRSH = Standard Cost of Standard Fixed overhead = ₹ 48,750

(2) SRAH = Standard Cost of Actual overhead = ₹ 49,500

(3) SRRBH = Revised Budgeted overheads = ₹ 46,800

(4) SRBH = Budgeted overheads = ₹ 45,000

(5) ARAH = Actual overheads = ₹ 50,000



### Computation of Required Variances

- FOH efficiency Variance = (1) - (2) = 750 (A)
- FOH Capacity Variance = (2) - (3) = 2,700 (F)
- FOH Calendar Variance = (3) - (4) = 1,800 (F)
- FOH Volume Variance = (1) - (4) = 3,750 (F)
- FOH Budget Variance = (4) - (5) = 5,000 (A)
- FOH Cost Variance = (1) - (5) = 1,250 (A)

### Variable Overhead Variances

#### Computation of Required Values

SRSR (1) (₹)	SRAH (2) (₹)	ARAH (3) (₹)
2 x 32,500	2 x 33,000	
65,000	66,000	68,000

$$SR = \left( \frac{\text{Budgeted Variable Overheads}}{\text{Budgeted Hours}} \right) = \frac{60,000}{30,000} = ₹ 2 \text{ per unit}$$

Where

- SRSR = Standard Cost of Variable overheads = ₹ 65,000
- SRAH = Standard Variable overhead for Actual Hours = ₹ 66,000
- ARAH = Actual Variable overhead = ₹ 68,000.

#### Computation of Required Variances:

- Variable overhead efficiency Variance = (1) - (2) = 1,000 (A)
- VOH Budget/ expenditure Variance = (2) - (3) = 2,000 (A)
- VOH Cost Variance = (1) - (3) = 3,000 (A)

### Illustration 18

The Cost Accountant of a Co. was given the following information regarding the OHs for Feb, 2013:

- Overhead Cost Variance ₹1,400 (A)
- Overheads Volume Variance ₹ 1,000 (A)
- Budgeted Hours for Feb, 2013: 1,200 Hours
- Budgeted OH for Feb, 2013: ₹ 6,000
- Actual Rate of Recovery of OH ₹ 8 per hour

You are required to assist him in computing the following for Feb, 2013

- OHs expenditure Variance
- Actual OH's incurred



3. Actual Hours for Actual Production
4. OHs Capacity Variance
5. OHs efficiency Variance
6. Standard Hours for Actual Production

**Solution:****Computation of Required Values**

SRSH (1) (₹)	SRAH (2) (₹)	SRBH (3) (₹)	ARAH (4) (₹)
5 x 1,000	5 x 800	5 x 1,200	8 x 800
<b>5,000</b>	<b>4,000</b>	<b>6,000</b>	<b>6,400</b>

1. SRSH - SRBH = Volume Variance

$$\text{SRSH} - 6,000 = 1,000$$

$$\text{SRSH} = 5,000 \text{ or } \text{SH} = \frac{5,000}{5} = 1,000$$

2. SRSH – ARAH = Cost Variance

$$5,000 - \text{ARAH} = 1,400$$

$$\text{ARAH} = 6,400$$

- a. Overhead expenditure Variance = 6,000 – 6,400 = ₹400 (A)
- b. Actual OH's Incurred = ₹ 6,400
- c. Actual Hours for Actual Production = 800 hours
- d. Overheads Capacity Variance = 4,000 – 6,000 = ₹ 2,000 (A)
- e. Overheads Efficiency Variance = 5,000 – 4,000 = 1,000 (F)
- f. Standard Hours for Actual Production = 1,000 hours

**Illustration 19**

Standard			Actual		
Quantity	S.P.	Total	Quantity	A.P.	Total
A – 1600	24	38,400	A – 2400	20	48,000
B – 1400	18	25,200	B – 1400	18	25,200
C – 600	12	7,200	C – 750	14	10,500
D – 400	15	6,000	D – 450	14	6,300
4000		76,800	5000		90,000

From the above data calculate various sales variances

**Solution:**

Material	AQAP (1) (₹)	AQSP (2) (₹)	RSQSP (3) (₹)	SQSP (4) (₹)
A		2,400 x 24	2,000 x 24	
B		1,400 x 18	1,750 x 18	
C		750 x 12	750 x 12	
D		450 x 15	500 x 15	

A	48,000	57,600	48,000	38,400
B	25,200	25,200	31,500	25,200
C	10,500	9,000	9,000	7,200
D	6,300	6,750	7,500	6,000
	90,000	98,550	96,000	76,800

$$RSQ = \left( \frac{SQ \text{ for that product}}{SQ \text{ for all products}} \right) \times AQ \text{ for all products}$$

$$\text{e.g.} = \frac{1,600}{4,000} \times 5,000 = 2,000 \text{ units}$$

1. AQAP = Actual Sales = ₹ 90,000
2. AQSP = Actual Quantity of Sales at Standard Prices = ₹ 98,550
3. RSQSP = Revised Standard on Budgeted Sales = ₹ 96,000
4. SQSP = Standard or Budgeted Sales ₹ 76,800
  - a. Sales Sub-Volume Variance      3 -4      ₹19,200 (F)
  - b. Sales Mix Variance                2-3      ₹ 2,550 (F)
  - c. Sales Volume Variance            2 -4      ₹ 21,750 (F)
  - d. Sales Price Variance               1- 2      ₹ 8,550 (A)
  - e. Sales Volume Variance            1-4      ₹ 13,200 (F)

**Illustration 20**

Budgeted and actual sales for the month of December, 2012 of two products A and B of M/s. XY Ltd. were as follows:

Product	Budgeted Units	Sales Price/Unit (₹)	Actual Units	Sales Price / Unit (₹)
A	6,000	₹5	5,000	5.00
			1,500	4.75
B	10,000	₹2	7,500	2.00
			1,750	8.50

Budgeted costs for Products A and B were ₹4.00 and ₹1.50 unit respectively. Work out from the above data the following variances.

Sales Volume Variance, Sales Value Variance, Sales Price Variance, Sales Sub Volume Variance, Sales Mix Variance.

**Solution:**

	(1)	(2)	(3)	(4)
	AQAP (₹)	AQSP (₹)	RSQSP (₹)	SQSP (₹)
A	5,000 × 5.00	6,500 × 5	5,906.25 × 5	6,000 × 5
	1,500 × 4.75			
B	7,500 × 2.00			
	1,750 × 1.90	9,250 × 2	9,843.75 × 2	10,000 × 2
A	25,000	32,500	29,531.25	30,000
	7,125			
B	15,000			
	3,325	18,500	19,687.5	20,000
	₹50,450	₹51,000	₹49,219	₹50,000

Revised Standard Quantity for

$$A = 6,000/16,000 \times 15,750 = 5,906.25 \text{ units}$$

$$B = 10,000/16,000 \times 15,750 = 9,843.75 \text{ units}$$

1. AQAP = Actual Sales = ₹50,450
2. AQSP = Actual Quantity of Sales at Standard Price = ₹51,000
3. RSQSP = Revised Budgeted or Standard Sales = ₹49,219
4. SQSP = Standard or Budgeted Sales = ₹50,000
  - a. Sales Sub Volume or Quantity Variance = 3 – 4 = ₹781 (A)
  - b. Sales Mix Variance = 2 – 3 = ₹1,781 (F)
  - c. Sales Volume Variance = 2 – 4 = ₹1,000 (F)
  - d. Sales Price Variance = 1 – 2 = ₹550 (A)
  - e. Sales Value Variance = 1 – 4 = ₹450 (F)

**Illustration 21**

From the following particulars for a period reconcile the actual profit with the budgeted profit.

	Budgeted	Actual
	(₹ lac)	(₹ lac)
Direct Material	50.00	66.00
Direct Wages	30.00	33.00
Variable overheads	6.00	7.00
Fixed overheads	10.00	12.00
Net Profit	4.00	8.50
	100.00	126.50

Actual material price and wage rates were higher by 10%. Actual sales prices are also higher by 10%.



**Solution:**

(Amount in ₹ lac)

Sales Price Variance =	$126.5 - [126.5 \times \frac{100}{110}] =$	11.5 (F)
Sales Volume Variance =	$[126.5 \times \frac{100}{110}] - 100 =$	15.0 (F)
Sales Value Variance =	$126.5 - 100 =$	26.5 (F)
% of Volume Increase =	15%	
Material Price Variance =	$[66 \times \frac{100}{110}] - 66 =$	6 (A)
Material Volume Variance =	$[50 \times \frac{15}{100}] =$	7.5 (A)
Material usage Variance =	$[50 \times \frac{115}{100}] - [66 \times \frac{100}{110}] =$	2.5 (A)
Material Cost Variance =	$50 - 66 =$	16 (A)
Wage Rate Variance =	$[33 \times \frac{100}{110}] - 33 =$	3 (A)
Wage Volume Variance =	$[30 \times \frac{15}{100}] =$	4.5 (A)
Wage efficiency Variance =	$[30 \times \frac{115}{100}] - [33 \times \frac{100}{110}] =$	4.5 (F)
Wage Cost Variance =	$30 - 33 =$	3.0 (A)
Variable overhead Volume Variance =	$[6 \times \frac{15}{100}] =$	0.9 (A)
Variable overheads efficiency Variance =	$[6 \times \frac{115}{100}] - 7 =$	0.1 (A)
Variable overhead Cost Variance =	$6 - 7 =$	1.0 (A)
Fixed overhead Cost Variance =	$10 - 12 =$	2.0 (A)

**Statement showing the reconciliation of budgeted profit with actual profit**

OR

**Profit Variance Statement**

(₹ in lakhs)

Budgeted Profit		4.00
Add: Sales Price Variance	11.50	
Sales Volume Variance	15.00	
Wage efficiency Variance	4.50	31.00
		35.00
Less: Material Price Variance	6.00	
Material Volume Variance	7.50	
Material usage Variance	2.50	
Wage Rate Variance	3.00	
Wage Volume variance	4.50	
Variable overhead Volume Variance	0.90	
Variable overheads efficiency Variance	0.10	
Fixed overhead Cost Variance	2.00	26.50
Actual Profit		8.50

**Illustration 22****(₹ in lakhs)**

	<b>31-3-2012</b>	<b>31-3-2013</b>
Sales	120	129.6
Prime cost of sales	80	91.1
Variable overheads	20	24.0
Fixed expenses	15	18.5
Profit	5	(4.0)

During 2012-13, average prices increased over these of the previous years

(1) 20% in case of Sales (2) 15% in case of Prime Cost (3) 10% in case of overheads.

Prepare a profit variance statement from the above data.

**Solution:****Calculation of variances:****(₹ in lakhs)**

- Sales Price Variance :  $129.60 - (129.60 \times 100/120) = 21.60$  (F)
- Sales Volume Variance :  $[120 - (129.60 \times 100/120)] = 12$  (A)
- Sales Value Variance :  $129.60 - 120 = ₹ 9.60$  (F)  
Decrease in Volume =  $120 - 12$   
 $100 - ? = 10\%$
- Prime Cost Price Variance :  $(91.10 \times 100/115) - 91.10 = ₹ 11.88$  (A)
- Prime Cost Volume Variance =  $80 \times 10/100 = ₹ 8$  (F)
- Prime Cost usage or efficiency Variance =  $(80 \times 90/100) - (91.10 \times 100/115) = ₹ 7.22$  (A)
- Prime Cost Variance :  $80 - 90.1 = ₹ 11.1$  (A)
- Variable overhead Price Variance =  $(24 \times 100/110) - 24 = ₹ 2.18$  (A)
- Variable overhead Volume Variance =  $20 \times 10/100 = ₹ 2$  (F)
- Variable overhead efficiency Variance =  $(20 \times 90/100) - (24 \times 100/110) = ₹ 3.82$  (A)
- Variable overhead Cost Variance =  $20 - 24 = ₹ 4$  (A)
- Fixed overhead Price Variance =  $(18.50 \times 100/110) - 18.50 = ₹ 1.68$  (A)
- Fixed overhead efficiency Variance =  $15 - (18.50 \times 100/110) = ₹ 1.82$  (A) [Fixed overhead will not change give to variation in volume]
- Fixed overhead Cost Variance =  $15 - 18.50 = ₹ 3.5$  (A)



### Profit Variance Statement

Particulars		(₹ in lakhs)
Profit for the year ending 31-3-2012		5.00
Add: Sales Price Variance	21.60	
Prime Cost Variance	8.00	
Variable overhead Variance	2.00	31.60
		36.60
Less: Sales Volume Variance	12.00	
Price Cost Price Variance	11.88	
Price Cost usage Variance	7.22	
Variable overhead Price Variance	2.18	
Variable overhead efficiency Variance	3.82	
Fixed overhead Price Variance	1.68	
Fixed overhead efficiency Variance	1.82	40.60
Loss for the year ending 31-3-2013		4.00

#### Illustration 23

ABC Ltd; adopts a Standard Costing System. The standard output for a period is 20,000 units and the standard cost and profit per unit is as under:

	(₹)
Direct Material (3 units @ ₹1.50)	4.50
Direct Labour (3 hrs. @ ₹ 1.00 )	3.00
Direct expenses	0.50
Factory overheads : Variable	0.25
Fixed	0.30
Administration overheads	0.30
Total Cost	8.85
Profit	1.15
Selling Price (Fixed by government)	10.00

The actual production and sales for a period was 14,400 units. There has been no price revision by the government during the period.

The following are the variances worked out at the end of the period:

		Favourable (₹)	Adverse (₹)
Direct Material			
	Price		4,250
	Usage	1,050	
Direct labour			
	Rate		4,000
	Efficiency	3,200	



Factory overheads			
	Variable – expenditure	400	
	Fixed – expenditure	400	
	Fixed – Volume		1,680
Administration overheads			
	Expenditure		400
	Volume		1,680

You are required to:

Ascertain the details of actual costs and prepare a Profit and Loss Statement for the period showing the actual Profit/Loss. Show working clearly.

Reconcile the Actual Profit with Standard Profit.

**Solution:**

**Statement showing the Actual Profit and Loss Statement**

Particulars	Amount (₹)	Amount (₹)
Standard Material Cost (14,400 x 4.50)	64,800	
Add: Price Variance	4,250	
Less: usage Variance	(1,050)	68,000
Standard Labour Cost (14,400 x 3)	43,200	
Add: Rate Variance	4,000	
Less: efficiency Variance	(3,200)	44,000
Direct expenses (14,400 x 0.50)		7,200
Prime Cost		1,19,200
Factory overhead:		
Variable (14,400 x 0.25)	3,600	
Less: expenditure Variance	(400)	3,200
Fixed (14,400 x 0.30)	4,320	
Add: Volume Variance	1,680	
Less: expenditure Variance	(400)	5,600
Administration overhead (14,400 x 0.3)	4,320	
Add: Volume Variance	1,680	
Add: exp. Variance	400	6,400
Total Cost		1,34,400 9,600
Profit (B/F)		
Sales		1,44,000



### Statement showing Reconciliation of Standard Profit with Actual Profit

Particulars	₹	₹
Standard Profit (14,400 x 1.15)		16,560
Add: Material usage Variance	1,050	
Labour efficiency Variance	3,200	
Variable overhead expenditure Variance	400	
Fixed overhead expenditure Variance	400	5,050
		21,610
Less: Material Price Variance	4,250	
Labour Rate Variance	4,000	
Fixed overhead Volume Variance	1,680	
Administration expenditure Variance	400	
Administration Volume Variance	1,680	12,010
Actual Profit		9,600

## GLOSSARY

**Basic Standard:** Basic standard is the standard established for use over a long period from which a current standard can be developed.

**Current Standard:** Current standard is a standard which is established for use over a short period of time and is related to current conditions.

**Fixed Overhead Calendar Variance:** Fixed Overhead Calendar Variance is that portion of the volume variance which is due to the difference between the number of working days in the budget period and the number of actual working days in the period to which the budget is applicable.

**Fixed Overhead Capacity Variance:** Fixed Overhead Capacity Variance is that portion of the volume which occurs due to working at higher or lower capacity than the standard capacity.

**Fixed Overhead Cost Variance:** Fixed Overhead Cost Variance is the difference between the standard cost of fixed overhead allowed for the actual output achieved and the actual fixed overhead cost incurred.

**Fixed Overhead Efficiency Variance:** Fixed Overhead Efficiency Variance is that portion of the volume variance which is due to the difference between the budgeted efficiency of production and the actual efficiency achieved.

**Fixed Overhead Expenditure Variance:** Fixed Overhead Expenditure Variance is the difference between the actual fixed overhead incurred and budgeted fixed overhead.

**Fixed Overhead Volume Variance:** Fixed Overhead Volume Variance is the difference between standard cost of fixed overhead allowed for actual output and the budgeted fixed overheads for the period.

**Idle Time Variance:** Idle time variance is the standard cost of actual time paid to workers for which they have not worked due to abnormal reasons.

**Inter Firm Comparison:** Inter Firm Comparison is the technique of evaluating the performances, efficiencies, deficiencies, costs and profits of similar nature of firms engaged in the same industry or business.



**Labour Cost Variance:** Labour cost variance is the difference between the actual labour costs and the standard labour costs.

**Labour Efficiency Variance:** Labour efficiency variance is the difference between the standard hours which should have been worked and the hours actually worked, valued at the standard wage rate.

**Labour Mix Variance:** Labour mix variance is the variance which arises due to change in the composition of a standard group, or, combination of labour force.

**Labour Rate Variance:** Labour rate variance is the difference between the actual and standard wage rate per hour applied to the total hours worked.

**Labour Yield Variance:** Labour yield variance is the variation in labour cost on account of increase or decrease in yield or output as compared to the relative standard.

**Material Cost Variance:** Material cost variance is the difference between standard material costs and actual material costs.

**Material Mix Variance:** Material mix variance is that part of material usage variance which arises from the difference between the standard mix and actual mix of different types of materials used in production.

**Material Price Variance:** Material price variance is the difference between the actual and standard price per unit of the material applied to the actual quantity of material purchased or used.

**Material Usage Variance:** Material usage variance is a part of material cost variance which reveals the deviation due to difference in quantity of material used.

**Material Yield Variance:** Material yield variance is the difference between the standard cost of production achieved and the actual total quantity of materials used, multiplied by the standard weighted average price per unit.

**Overhead Variance:** Overhead Variance is the difference between the standard cost of overhead allowed for actual output and the actual overhead incurred.

**Profit Variance:** Profit Variance is the difference between budgeted profit and actual profit.

**Profit Price Variance:** Profit Price variance is the difference between standard and actual profit on actual volume of sales.

**Profit Volume Variance :** Profit Volume Variance is the difference between the standard and the actual volume of sales.

**Sales Mix Variance:** Sales Mix Variance occurs when the actual quantities sold are not in the same proportion as budgeted.

**Sales Price Variance:** Sales Price Variance is the difference in actual selling price and the standard selling price for actual quantity of sales.

**Sales Quantity Variance:** Sales Quantity Variance is the difference between budgeted sales and the revised standard sales.

**Sales Value Variance:** Sales Value Variance is the difference between actual value of sales and budgeted value of sales.

**Sales Volume Variance:** Sales Volume Variance is the difference between budgeted sales and standard sales.

**Standard Cost:** Standard cost is a pre-determined cost which shows in advance what each product should cost under the given situation.



**Standard Costing:** Standard costing is a technique which uses standards for costs and revenue for the purpose of control through variance analysis.

**Standard Price:** Standard price is a pre-determined price fixed on the basis of a specification of a product or service and of all factors affecting the price.

**Standard Time:** Standard time is the total time in which a task should be completed at standard performance, i.e. basic time plus contingency time allowance plus allowance for relaxation.

**Uniform Costing:** Uniform Costing may be defined as the application and use of the same costing principles and procedures by different organisations under the same management or on a common understanding between members of an association.

**Variable Overhead Variance:** Variable Overhead Variance is the difference between the standard variable overhead cost allowed for the actual output achieved and the actual variable overhead cost.

**Variance:** The deviation of actual from standard is called variance. When actual cost is less than the standard cost, it is known as 'favourable variance'. When actual cost is more than the standard cost, it is known as 'unfavourable or adverse variance'. It is also referred to as a measure of dispersion defined as the mean squared deviation from the expected value.

**Variance Analysis:** Variance analysis is the analysis of variances arising in standard costing system into their constituent parts.

#### SELF LEARNING QUESTIONS:

1. Distinguish between Budgetary control and Standard Costing.
2. List down the benefits and limitation accrue out of Standard Costing.
3. Discuss various types of standards.
4. Define and explain the sales variances based on a] profits and b] turnover.
5. Define and explain briefly the following terms:
  - A. Material price variance
  - B. Material usage variance
  - C. Material mixture variance
  - D. Material yield variance
6. Define and explain briefly the following terms:
  - A. Wage rate variance
  - B. Labour efficiency variance
  - C. Variable overhead efficiency variance
7. Define and explain the following terms:
  - A. Fixed overhead cost variance
  - B. Fixed overhead volume variance
  - C. Fixed overhead capacity variance
  - D. Fixed overhead calendar variance
8. List down the objective of Uniform Costing.



9. List down the benefits and limitation accrue out of Uniform Costing.
10. List down the benefits and limitation accrue out of Inter Firm Comparison.

**Multiple Choice Questions:**

1. Which of the following is true about standard costs?
  - A. They are the actual costs for delivering a product or service under normal conditions
  - B. They are predetermined costs for delivering a product or service under normal conditions.
  - C. They are the actual costs for producing a product under normal conditions
  - D. They are predetermined costs for delivering a product or service under normal and abnormal conditions.
2. Which of the following is true?
  - A. Standard costs are predetermined rates for materials and labour only.
  - B. Standard costs are predetermined rates for materials only.
  - C. Standard costs are based on actual activity at the end of the period
  - D. Standard costs are predetermined rates for materials, labour, and overhead.
3. Which of the following is often the cause of differences between actual and standard costs of materials and labour?
  - A. Price changes for materials
  - B. Excessive labour hours
  - C. Excessive use of materials
  - D. All of the above
4. Which of the following can be used to calculate the materials price variance?
  - A.  $(AQ - SQ) \times SP$
  - B.  $(AP - SP) \times AQ$
  - C.  $(AP - SP) \times SQ$
  - D.  $(AQ - SQ) \times AP$
5. Which of the following is the difference between actual and standard cost of material caused by the actual quantity of material used exceeding the standard quantity of material allowed?
  - A. Price variance
  - B. Mix variance
  - C. Quantity variance
  - D. Yield variance
6. Which of the following departments is most likely responsible for a price variance in direct materials?
  - A. Warehousing
  - B. Receiving
  - C. Purchasing
  - D. Production





7. The overhead variance is caused by the difference between which of the following?
  - A. Actual overhead and standard overhead applied
  - B. Actual overhead and overhead budgeted at the actual operating level
  - C. Standard overhead applied and budgeted overhead
  - D. Budgeted overhead and overhead applied
8. When are the overhead variances recorded in a standard costing system?
  - A. When the cost of goods sold is recorded
  - B. When the factory overhead is applied to work-in-process
  - C. When the goods are transferred out of work-in-process
  - D. When direct labour is recorded
9. Which of the following is true when recording variances in a standard costing system?
  - A. All unfavourable variances are debited
  - B. Only unfavourable material variances are credited.
  - C. Only unfavourable material variances are debited.
  - D. Only unfavourable variances are credited.
10. Which of the following operating measures would a manager want to see decreasing over time?
  - A. Merchandise inventory turnover
  - B. Total quality cost
  - C. Percentage of on-time deliveries
  - D. Finished goods inventory turnover
11. Idle time variance is obtained by multiplying
  - A. The difference between standard and actual hours by the standard rate of labour per hour
  - B. The difference between actual labour hours paid and actual labour hours worked by the standard rate
  - C. The difference between standard and actual hours by the actual rate of labour per hour
  - D. None of the above.

[Ans: B, D, D, B, C, C, A, B, A, B, B]

**Match the following:**

	Column A		Column B
1	Inter firm comparison	A	Technique to assist inter-firm comparison
2	Calendar Variance	B	Standard Sales – Actual Sales
3	Ind As-2	C	Difference between Standard and Actual cost
4	Variance Analysis	D	Standard rate per hour X Deficit hour worked
5	Difficulty of inter firm comparison	E	Budgeted Sales – Actual Sales
6	Sales Price variance	F	About its utility
7	Uniform Costing	G	Inventory valuation
8	Uniform Costing	H	Technique of Costing
9	Variance Analysis	I	Technique for evaluating performance
10	Sales value variance	J	Management by Exception

[Ans: I, D, G, A, F, B, H, J, C, E]



**State whether the following statement is True or False:**

1. Standard costing works on the principle of exception.
2. An increase in production means an increase in overall productivity.
3. Difference between the standard cost and actual cost is called as variance.
4. Uniform costing helps in free exchange of ideas among the participating members.
5. A variance may be either favourable or adverse.
6. There is no difference between standard costing and budgeting.
7. The objective of uniform costing is wealth maximisation.
8. Uniform costing is a method of costing.
9. Uniform costing is a must for meaningful in a firm comparison.
10. Standards are arrived at on the basis of past performance.

[Ans: 1. True, 2. False, 3. True, 4. True, 5. True, 6. False, 7. True, 8. False, 9. True, 10. False]

**Fill in the Blanks:**

1. Ideal time variance is always \_\_\_\_\_.
2. Material usage variance is the sum of \_\_\_\_\_.
3. \_\_\_\_\_ is a must for meaningful inter firm comparison.
4. Standard cost is the \_\_\_\_\_ cost.
5. Uniform costing is a \_\_\_\_\_ of costing.
6. Inter firm comparison is the technique of evaluation of \_\_\_\_\_.
7. Standard cost is a \_\_\_\_\_ cost.
8. Three types of standard \_\_\_\_\_.
9. Standards costing are applied in \_\_\_\_\_ industry.
10. When standard cost is less than the standard cost, it is known as \_\_\_\_\_ variance.

[Ans: 1. Adverse, 2. Mix Variance and Yield variance, 3. Uniform Costing, 4. Predetermined Cost, 5. Technique, 6. Performance, 7. Predetermined, 8. Basic Standard & Normal Standard, 9. Engineering, 10. Favourable.]

# Study Note - 5

## LEARNING CURVE



### This Study Note includes

- 5.1 Introduction
- 5.2 Phases in Learning Curve
- 5.3 Uses of Learning Curve
- 5.4 Limitations to the usefulness of the Learning Curve
- 5.5 Factors Affecting Learning Curve
- 5.6 The Experience Curve
- 5.7 Reasons for use of Learning Curve
- 5.8 Application of Learning Curve

### 5.1 INTRODUCTION

Learning curve is essentially a measure of the experience gained in production of an article by an individual or organization. As more units are produced, people involved in production become more efficient than before. Each subsequent unit takes fewer man-hours to produce. Learning Curve Theory is concerned with the idea that when a new job, process or activity commences for the first time it is likely that the workforce involved will not achieve maximum efficiency immediately. Repetition of the task is likely to make the people more confident and knowledgeable and will eventually result in a more efficient and rapid operation. Eventually the learning process will stop after continually repeating the job. As a consequence the time to complete a task will initially decline and then stabilise once efficient working is achieved. The cumulative average time per unit is assumed to decrease by a constant percentage every time that output doubles. Cumulative average time refers to the average time per unit for all units produced so far, from and including the first one made.

Learning is the process by which an individual acquires skill, knowledge and ability. When a new product or process is started, the performance of a worker is not at its best and learning phenomenon takes place. As the experience is gained, the performance of a worker improves, time taken per unit activity reduces and his productivity goes up. This improvement in productivity of a worker is due to learning effect. Cost predictions especially those relating to direct labour cost must allow for the effect of learning process. This technique is a mathematical technique. It can be very much used to accurately and graphically predict cost. It is a geometrical progression, which reveals that there is steadily decreasing cost for the accomplishment of a given repetitive operation, as the identical operation is increasingly repeated. The amount of decrease is less and less with each successive unit produced. The slope of the decision curve can be expressed as a percentage. Experience curve, improvement curve and progress curve are other terms which can be synonymously used.

### 5.2 PHASES IN LEARNING CURVE

The learning curve will pass through three different phases. In the first phase, there will be gradual increase in production rate until the maximum expected rate is reached and this phase is generally steep. In the second phase, the learning rate will gradually deteriorate because of the limitations of equipment. In the third phase, the production rate begins to decrease due to a reduction in customer requirements and increase in costs.



Under the Learning curve model, the cumulative average time per unit produced is assumed to fall by a constant percentage every time total output of the unit doubles. Learning curve is a geometrical operation, as the identical operation is increasingly repeated.

Learning curve is essentially a measure of the experience gained in production of an article by an organization. As more and more units re-produced, workers involved in production become more efficient than before. Each subsequent unit takes fewer manhours or produce. The Learning curve exists during a worker's start up or familiarization period on a particular job. After the limits of experimental learning are reached, productivity tends to stabilize and no further improvement is possible. The learning curve ratio can be calculated with the help of the following formula:

$$\text{Learning curve ratio} = \frac{\text{Average cost of first 2 units}}{\text{Average labour cost of first units}}$$

### Areas of consequence

- A Standard Costing system would need to set standard labour times after the learning curve had reached a plateau.
- A budget will need to incorporate a learning cost factor until the plateau is reached.
- A budgetary control system incorporating labour variances will have to make allowances for the anticipated time changes.
- Identification of the learning curve will permit the company to better plan its marketing, work scheduling, recruitment and material acquisition activities.
- The decline in labour costs will have to be considered when estimating the overhead apportionment rate.
- As the employees gain experience they are more likely to reduce material wastage.

### Graphical presentation of learning curve

The learning curve (not to be confused with experience curve) is a graphical representation of the phenomenon explained by Theodore P. Wright in his "Factors Affecting the Cost of Airplanes", 1936. It refers to the effect that learning had on labour productivity in the aircraft industry, which translates into a relation between the cumulative number of units produced (X) and the average time (or labour cost) per unit (Y), which resulted in a convex downward slope, as seen in the adjacent diagram.

**There is a simple rationalisation behind all this:** the more units produced by a given worker, the less time this same worker will need to produce the following units, because he will learn how to do it faster and better. Therefore, when a firm has higher cumulative volume of production, its time (or labour cost) per unit will be lower. Wright's learning curve model is defined by the following function:

$$Y = aX^{\frac{\log b}{\log 2}}$$

where:

Y = average time (or labour cost) per unit

a = time (or labour cost) per unit

X = cumulative volume of production

b = learning rate (%)

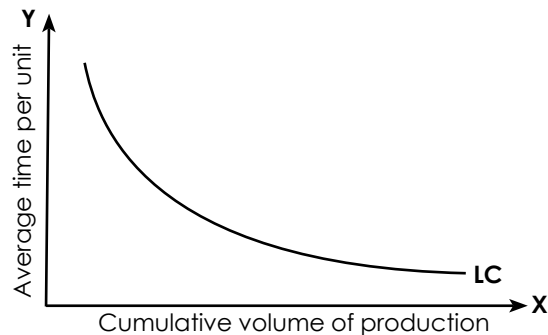

Some important implications arise from this curve. If the time (or labour cost) per unit decreases as the cumulative output increases, this will mean that firms that have been producing more and for a longer period, will have lower average time per unit and thus dominate the market.

### 5.3 USES OF LEARNING CURVE

Learning curve is now being widely issued in business. Some of the uses are as follows:

1. Where applicable the learning curve suggest great opportunities for cost reduction to be achieved by improving learning.
2. The learning curve concept suggests a basis for correct staffing in continuously expanding production. The curve shows that the work force need not be increased at the same rate as the prospective output. This also helps in proper production planning through proper scheduling of work; providing manpower at the right moment permitting more accurate forecast of delivery dates.
3. Learning curve concept provides a means of evaluating the effectiveness of training programs. What level of cumulative cost reduction do they accomplish? How does the learning curve for this group or shop compare with others? Whether any of the employees who lack the aptitude to meet normal learning curve should be eliminated.
4. Learning curve is frequently used in conjunction with establishing bid price for contracts. Usually, the bid price is based on the cumulative average unit cost for all the units to be produced for a given contract. If production is not interrupted. Additional units beyond this quantity should be costed at the increment costs incurred, and not at the previous cumulative average. If the contract agreement so provides, a contract may be cancelled and production stopped before the expected efficiency is reached. This would mean that the company having quoted on the basis of cumulative average unit cost is at a disadvantage because it cannot reap the benefit of leaning. The contractor must provide for these contingencies so that it will be reimbursed for such loss.
5. The use of learning curve, where applicable, is important in the working capital required. If the requirement is based on average cumulative unit cost, the revenues from the first few units may not cover the actual expenditures. For instance, if the price was based on the average cumulative unit cost of 328 hours the first unit when produced and sold will cause a deficit of 4.72 hours (8.00 - 3.28). Provision should therefore, be made to cover the deficit of working capital in the initial stages of production.
6. As employees become more efficient, the rate of production increases and so more materials are needed, the work-in-progress inventory turns over faster, and finished goods inventory grows at an accelerated rate. A knowledge of the learning curve assists in planning the inventories of materials. Work-in-progress, and finished goods.



7. Learning curve techniques are useful in exercising control, Variable norms can be established for each situation, and a comparison between these norms and actual expenses can be made. Specific or average incremental unit cost should be used for this purpose.
8. The learning curve may be used for make-or- buy decisions especially if the outside manufacturer has reached the maximum on the learning curve. Help to calculate the sensitive rates in wage bargaining.

#### 5.4 LIMITATIONS OF THE USEFULNESS OF THE LEARNING CURVE

The following points limiting the usefulness of learning curves should be noted:-

1. The learning curve is useful only for new operations where machines do not constitute a major part of the production process. It is not applicable to all productions. E.g. new and experienced workmen.
2. The learning curve assumes that the production will continue without any major interruptions. If for any reason the work is interrupted, the curve may be deflected or assume a new slopes
3. Charges other than learning may effect the learning curve. For example, improvement in facilities, arrangements, and equipment as well as personnel morale and performance may be factors influencing the curve. On the other hand, negative developments in employee attitudes may also affect the curve and reverse or retard the progress of improvement.
4. The characteristic 80 percent learning curve as originally obtaining in the air force industry in U.S. A. has been usually accepted as the percentage applicable to all industries. Studies show that there cannot be a unique percentage which can be universally applied.

#### 5.5 FACTORS AFFECTING LEARNING CURVE

1. While pricing for bids, general tendency is to set up a very high initial labour cost so as to show a high learning curve. This causes the learning curve useless and sometimes misleading.
2. The method of production, i.e. whether it is labour oriented or machine oriented influences the slope of the learning.
3. When labour turnover rate is high management has to train new workers frequently. In such situations the company may never reach its maximum efficiency potential. One of the important requisites of the learning curve concept is that there should be uninterrupted flow of work. The fewer the interruptions, the grater will be the improvement in efficiency.
4. Changes in a product or in the methods of production, designs, machinery, or the tools/used affect the slope of the learning curve. All these have the effect of starting learning a fresh because of new conditions If the changes are frequent, there may be no learning at all.
5. Also other factors influencing the learning curve are labour strikes, lock outs and shut downs due to other cause also/affect the learning curve. In each such case there is interruption in the progress of learning.

As far as possible the effects of above factors should be carefully separated from the data used to establish the curve. The effects of these factors must also be separated from the actual costs used to measure the performance. Unless this is done analysis of the projected cost or the actual cost will not be meaningful.



## 5.6 THE EXPERIENCE CURVE

Experience Curve is an idea developed by the Boston Consulting Group (BCG) in the mid-1960s which states that the more experience a firm has in producing a particular product, the lower are its costs. Boston Consulting Group (BCG) in the mid-1960s. Working with a leading manufacturer of semiconductors, the consultants noticed that the company's unit cost of manufacturing fell by about 25% for each doubling of the volume that it produced. This relationship they called the experience curve: the more experience a firm has in producing a particular product, the lower are its costs. Bruce Henderson, the founder of BCG, put it as follows:

Costs characteristically decline by 20-30% in real terms each time accumulated experience doubles. This means that when inflation is factored out, costs should always decline. The decline is fast if growth is fast and slow if growth is slow.

There is no fundamental economic law that can predict the existence of the experience curve, even though it has been shown to apply to industries across the board. Its truth has been proven inductively, not deductively. And if it is true in service industries such as investment banking or legal advice, the lower costs are clearly not passed on to customers.

By itself, the curve is not particularly earth shattering. Even when BCG first expounded the relationship, it had been known since the second world war that it applied to direct labour costs. Less labour was needed for a given output depending on the experience of that labour. In aircraft production, for instance, labour input decreased by some 10-15% for every doubling of that labour's experience.

The strategic implications of the experience curve came closer to shattering earth. For if costs fell (fairly predictably) with experience, and if experience was closely related to market share (as it seemed it must be), then the competitor with the biggest market share was going to have a big cost advantage over its rivals. QED: being market leader is a valuable asset that a firm relinquishes at its peril.

This was the logical underpinning of the idea of the growth share matrix. The experience curve justified allocating financial resources to those businesses (out of a firm's portfolio of businesses) that were (or were going to be) market leaders in their particular sectors. This, of course, implied starvation for those businesses that were not and never would be market leaders.

Over time, managers came to find the experience curve too imprecise to help them much with specific business plans. Inconveniently, different products had curves of a different slope and different sources of cost reduction. They did not, for instance, all have the same downward gradient as the semiconductor industry, where BCG had first identified the phenomenon. A study by the Rand Corporation found that "a doubling in the number of [nuclear] reactors [built by an architect-engineer] results in a 5% reduction in both construction time and capital cost".

Part of the explanation for this discrepancy was that different products provided different opportunities to gain experience. Large products (such as nuclear reactors) are inherently bound to be produced in smaller volumes than small products (such as semiconductors). It is not easy for a firm to double the volume of production of something that it takes over five years to build, and whose total market may never be more than a few hundred units.

In theory, the experience curve should make it difficult for new entrants to challenge firms with a substantial market share. In practice, new firms enter old industries all the time, and before long many of them become major players in their markets. This is often because they have found ways of by passing what might seem like the remorseless inevitability of the curve and its slope. For example, experience can be gained not only first-hand, by actually doing the production and finding out for yourself, but also second-hand, by reading about it and by being trained by people who have firsthand experience. Furthermore, firms can leapfrog over the experience curve by means of innovation and invention. All the experience in the world in making black and white television sets is worthless if everyone wants to buy colour ones.

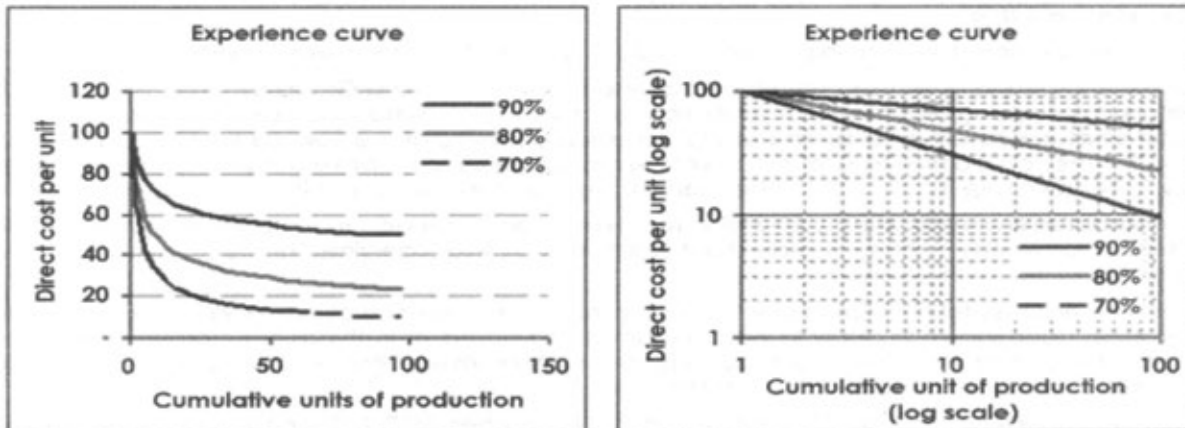

### 5.7 REASONS FOR USE OF LEARNING CURVE

There are a number of reasons why the experience curve and learning curve apply in most situations. They include:

**Labour efficiency** - Workers become physically more dexterous. They become mentally more confident and spend less time hesitating, learning, experimenting, or making mistakes. Over time they learn short-cuts and improvements. This applies to all employees and managers, not just those directly involved in production.

**Standardization, specialization, and methods improvements** - As processes, parts, and products become more standardized, efficiency tends to increase. When employees specialize in a limited set of tasks, they gain more experience with these tasks and operate at a faster rate.

**Technology-Driven Learning** - Automated production technology and information technology can introduce efficiencies as they are implemented and people learn how to use them efficiently and effectively.

**Better use of equipment** - as total production has increased; manufacturing equipment will have been more fully exploited, lowering fully accounted unit costs. In addition, purchase of more productive equipment can be justifiable.

**Changes in the resource mix** - As a company acquires experience, it can alter its mix of inputs and thereby become more efficient.

**Product redesign** - As the manufacturers and consumers have more experience with the product, they can usually find improvements. This filters through to the manufacturing process. A good example of this is Cadillac's testing of various "bells and whistles" specialty accessories. The ones that did not break became mass produced in other General Motors products; the ones that didn't stand the test of user "beatings" were discontinued, saving the car company money. As General Motors produced more cars, they learned how to best produce products that work for the least money.

**Value chain effects** - Experience curve effects are not limited to the company. Suppliers and distributors will also ride down the learning curve, making the whole value chain more efficient.

**Network-building and use-cost reductions** - As a product enters more widespread use, the consumer uses it more efficiently because they're familiar with it. One fax machine in the world can do nothing, but if everyone has one, they build an increasingly efficient network of communications. Another example is email accounts; the more there are, the more efficient the network is, the lower everyone's cost per utility of using it.

**Shared experience effects** - Experience curve effects are reinforced when two or more products share a common activity or resource. Any efficiency learned from one product can be applied to the other products.





## 5.8 APPLICATION OF LEARNING CURVE

### Application of Learning Curve

Learning curve may be applied to direct labor, materials and spoilage and defective work.

**Direct Labour:** Direct Labour is the general application area of the learning curve since it is only people who are capable of learning. Learning presupposes a certain degrees of inexperience in the performance of an activity and as such, the learning curve is mainly applicable to new activities and new labour force, whether employed on new or old activities.

**Materials** - Materials respond to learning only in an indirect way under specific circumstances. A learning curve is applicable mainly to sub-contract or fabrication order placed outside or component purchased from suppliers. The cost of the sub-contract or the components purchased would normally contain an element of labour and the purchaser will expect that at least a part of the benefit of learning should be passed on to him in the form of reduced price for the repeat orders for the sub-contract components.

**Spoilage and defective work:** This is also an area for learning because with the acquirement of more skill and efficiency, losses on account of spoilage and defective production would decline.

On the other hand, the concept of learning curve may not be gainfully applicable in the following cases:

- (i) Where machine work predominates and the operation time is limited by the speed and feed of the machine.
- (ii) In old established industries where no substantial change takes place.
- (iii) In industries which do not receive repeat orders.
- (iv) In small units where the quantity of production is small and costs are low.

### Distinctive Features of Learning Curve Theory

- (i) Learning curve is not a cost reduction technique. It is a naturally occurring human phenomenon.
- (ii) It is a human characteristic that a person engaged in repetitive task will improve his performance over time.
- (iii) In the initial stage of production, generally the workers do not have the confidence of completing the job successfully. When they produce a few units, they gain confidence. People learn from errors.
- (iv) When the workers produce more and more units, they come to know the problems and their reasons. Now they are able to avoid the problems.
- (v) The workers are able to find the new methods of doing the job; they are able to complete task in less time.
- (vi) Better equipments and tools are developed.
- (vii) Better product designs lead to increased efficiency.

### Illustration 1

The usual learning curve model is  $Y = ax^b$  where

Y is the average time per unit for x units.

a is the time for first unit

x is the cumulative number of units



b is the learning coefficient and is equal to  $\log 0.8 / \log 2 = 0.322$  of a learning rate of 80%

Given that a = 10 hours and learning rate 80%, you are required to Calculate:

- (i) The average time for 20 units.
- (ii) The total time for 30 units.
- (iii) The time for units 31 to 40.

Given that  $\log 2 = 0.301$ , Antilog of 0.5811 = 3.812  
 $\log 3 = 0.4771$ , Antilog of 0.5244 = 3.345.  
 $\log 4 = 0.6021$ , Antilog of 0.4841 = 3.049.

**Solution:**

(i)  $Y = ax^b$

$$Y = 10(20)^{-0.322}$$

Taking log on both sides

$$\text{Log } y = \log 10 + \log 20^{(-0.322)}$$

$$\text{Log } y = \log 10 - (0.322) \log 20$$

$$= 1 - (0.322) \log 20$$

$$= 1 - (0.322) \times (1.3010)$$

$$= 1 - 0.41892 = 0.5811$$

$$\text{Log } y = 0.5811$$

$$Y = \text{Anti log } (0.5811) = 3.812 \text{ hrs (average time)}$$

(ii)  $\text{Log } y = \log 10 + \log 30^{(-0.322)}$

$$\text{Log } y = 1 - (0.322) \times (1.4771)$$

$$= 1 - (0.4756) = 0.5244$$

$$Y = \text{anti log } (0.5244) = 3.345 \text{ hrs (average time)}$$

$$\text{Total time} = 3.345 \times 30 = 100.35 \text{ hrs}$$

(iii)  $\text{Log } y = \log 10 + \log 40^{(-0.322)}$

$$= 1 - (0.322) \times (1.6021)$$

$$\text{Log } y = 0.4841$$

$$Y = \text{anti log } (0.4841) = 3.049 \text{ hrs}$$

$$\text{Total time} = 40 \times 3.049 = 121.96 \text{ hrs}$$

$$\text{Time from 31 to 40 units} = 121.96 - (100.35) = 21.61 \text{ hrs}$$

**Illustration 2**

The learning curve as a management accounting has now become or going to become an accepted tool in industry, for its applications are almost unlimited. When it is used correctly, it can lead to increase business and higher profits; when used without proper knowledge, it can lead to lost business and bankruptcy.



State precisely:

- (i) Your understanding of the learning curve;
- (ii) The theory of learning curve;
- (iii) The areas where learning curves may assist in management accounting; and
- (iv) Illustrate the use of learning curves for calculating the expected average units cost of making. 4 machines (b) 8 machines

**Using the data below:**

**Data:**

Direct Labour need to make first machine	= 1,000 hrs.
Learning curve	= 90%
Direct Labour cost	= ₹ 15 per hour.
Direct materials cost	= ₹ 1,50,000
Fixed cost for either size orders	= ₹ 60,000.

**Solution:**

Statement showing computation of cost of making 4 machines & 8 machines:

No of Machines	Average time Hours	Labour cost (₹)	Material (₹)	Fixed cost (₹)	Total (₹)
1	1,000	15,000	1,50,000	60,000	2,25,000
2	900	13,500	1,50,000	30,000	1,93,500
4	810	12,150	1,50,000	15,000	1,77,150
8	729	10,935	1,50,000	7,500	1,68,435

Average cost of making 4 machines ₹1,77,150

Average cost of making 8 machines ₹ 1,68,435

### Illustration 3

Z.P.L.C experience difficulty in its budgeting process because it finds it necessary to qualify the learning effect as new products are introduced.

Substantial product changes occur and result in the need for retraining.

An order for 30 units of a new product has been received by Z.P.L.C So far, 14 have been completed; the first unit required 40 direct labour hours and a total of 240 direct labour has been recorded for the 14 units. The production manager expects an 80% learning effect for this type of work.

The company use standard absorption costing. The direct costs attributed to the centre in which the unit is manufactured and its direct materials costs are as follows:

	(₹)
Direct material	30.00 per unit.
Direct Labour	6.00 per hour.
Variable overhead	0.50 per direct labour hour.
Fixed overhead	6,000 per four-week operating period.

There are ten direct employees working a five-day week, eight hours per day. Personal and other downtime allowances account for 25% of total available time.



The company usually quotes a four-week delivery period for orders.

**You are required to:**

- (i) Determine whether the assumption of an 80% learning effect is a reasonable one in this case, by using the standard formula  $y = ax^b$

Where Y = the cumulative average direct labour time per unit (productivity)

a = the average labour time per unit for the first batch.

x = the cumulative number of batches produced.

b = the index of learning.

- (ii) Calculate the number of direct labour hours likely to be required for an expected second order of 20 units.
- (iii) Use the cost data given to produce an estimated product cost for the initial order, examine the problems which may be created for budgeting by the presence of the learning effect.

**Solution:**

- (i) Total time taken to produce 14 units

$$Y = ax^b$$

$$Y = 40(14)^{-0.322}$$

$$= 17.14$$

$$\text{Total time} = 17.14 \times 14 = 239.96 = 240 \text{ hours}$$

It is true that learning ratio 80% is effective.

- (ii) 30 units

$$Y = 40(30)^{-0.322} = 13.380 \text{ hours (Average time)}$$

50 units

$$Y = 40(50)^{-0.322} = 11.35 \text{ hours (Average time)}$$

$$\text{Total time for 30 units} = 13.38 \times 30 = 401.4 \text{ hours}$$

$$\text{Total time for 50 units} = 11.35 \times 50 = 567.5 \text{ hours}$$

$$\text{Time taken for 20 units from 31 to 50 units} (567.5 - 401.4) = 166.1 \text{ hours}$$

- (iii)

Man hours = $10 \times 8 \times 5 \times 4$	1,600
(-) down time	400
	1,200

$$\text{Fixed Cost per hour} = 6,000/1,200 = ₹ 5$$

Computation of total cost for the initial order

	(₹)
Material (30 × 30)	900.0
Labour (401.4 × 6)	2408.4
Variable Overheads (0.5 × 401.4)	200.7
Fixed Overheads (5 × 401.4)	2007.0
	5516.1



#### Illustration 4

A firm received an order to make and supply eight units of standard product which involves intricate labour operations. The first unit was made in 10 hours. It is understood that this type of operations is subject to 80% learning rate. The workers are getting a wages rate of ₹ 12 per hour.

- (i) What is the total time and labour cost required to execute the above order?
- (ii) If a repeat order of 24 units is also received from the same customer, what is the labour cost necessary for the second order?

#### Solution:

80% Learning Curve results are given below:

Production (Units)	Cumulative Average Time (hours)	Total Time (hours)
1	10	10
2	8	16
4	6.4	25.6
8	5.12	40.96
16	4.096	65.54
32	3.2768	104.86

Labour time required for first eight units = 40.96 hours

Labour cost required for 8 units = 40.96 hours × ₹ 12/hr = ₹ 491.52

Labour time for 32 units = 104.86 hours

Labour time for first eight units = 40.96 hours

Labour time required for 2<sup>nd</sup> order for 24 units = 63.90 hours

Labour cost for 24 units = 63.90 hours × ₹ 12/hr = ₹ 766.80

#### Illustration 5

The learning curve as a management accounting has now become or going to become an accepted tool in industry, for its applications are almost unlimited. When it is used correctly, it can lead to increase business and higher profits; when used without proper knowledge, it can lead to lost business and bankruptcy. State precisely:

- (i) Your understanding of the learning curve;
- (ii) The theory of learning curve;
- (iii) The areas where learning curves may assist in management accounting; and
- (iv) Illustrate the use of learning curves for calculating the expected average units cost of making, (a) 4 machines (b) 8 machines using the data below:

Data:

Direct Labour need to make first machine = 1000 hrs.

Learning curve = 90%

Direct Labour cost = ₹ 15/- per hour.

Direct materials cost = ₹ 1,50,000

Fixed cost for either size orders = ₹ 60,000.

**Solution:**

Statement showing computation of cost of making 4 machines & 8 machines:

No. of machines	Average time	Labour cost	Material	Fixed cost	Total
1	1000	15000	150000	60000	225000
2	900	13500	150000	30000	193500
4	810	12150	150000	15000	177150
8	729	10935	150000	7500	168435

Average cost of making 4 machines ₹1,77,150

Average cost of making 8 machines ₹ 1,68,435

1. Discuss the applicability of Learning Curve in the following situation;
  - (i) A set of very experienced people feed data into the computer for processing inventory records in the factory. The manager wishes to apply 80% learning rate on data entry and calculation of inventory.
  - (ii) A new type of machinery is to be installed in the factory. This is patented process and the output may take a year for full fledged production. The factory manager wants to use a learning rate on the workers at the new machine.
  - (iii) An operation uses contract labour. The contractor shifts people among various jobs once in two days. The labour force performs one task in 3 days. The manager wants to apply an average learning rate of these workers.

## GLOSSARY

**Experience Curve:** Experience Curve is an idea developed by the Boston Consulting Group (BCG) in the mid-1960s which states that the more experience a firm has in producing a particular product, the lower are its costs.

**Learning Curve:** Learning Curve is essentially a measure of the experience gained in production of an article by an individual or organisation. As more units are produced, people involved in production become more efficient than before. Each subsequent unit takes fewer man-hours to produce.

Learning Curve ratio = Average cost of first 2 units/ Average labour cost of first unit.

### Self Learning Questions:

1. Explain the concept of Learning Curve. How can it be applied to Cost Management?
2. State the usefulness of Learning Curve.
3. What are the factors affecting Learning Curve?
4. Write a short note on Experience curve.
5. Describe the distinctive features of Learning Curve.
6. Discuss the application of Learning Curve.
7. Briefly explain the Learning Curve ratio.
8. Discuss the relevance of Learning Curve to pricing decision.
9. Is manufacturing organisation can be benefited by the use of Learning Curve. Please comment.
10. What is the limitation to Learning Curve Theory?



**Section B**  
**Financial Management**  
**(Syllabus - 2016)**









# Study Note - 6

## INTRODUCTION TO FINANCIAL MANAGEMENT



### This Study Note includes

- 6.1 Meaning
- 6.2 Objectives
- 6.3 Scope of Financial Management
- 6.4 Sources of Finance
- 6.5 Introduction to Financial Markets

### 6.1 MEANING

#### INTRODUCTION

Finance is called "The science of money". It studies the principles and the methods of obtaining control of money from those who have saved it, and of administering it by those into whose control it passes. Finance is a branch of economics till 1890. Economics is defined as study of the efficient use of scarce resources. The decisions made by business firm in production, marketing, finance and personnel matters form the subject matters of economics. Finance is the process of conversion of accumulated funds to productive use. It is so intermingled with other economic forces that there is difficulty in appreciating the role of it plays.

Howard and Uptron in his book introduction to Business Finance defined, "as that administrative area or set of administrative function in an organization which relate with the arrangement of cash and credit so that the organization may have the means to carry out its objectives as satisfactorily as possible".

In simple terms finance is defined as the activity concerned with the planning, raising, controlling and administering of the funds used in the business. Thus, finance is the activity concerned with the raising and administering of funds used in business.

#### Financial Management: Meaning

Financial Management is managerial activity which is concerned with the planning and controlling of the firm's financial resources.

#### Definitions

Financial Management comprises of forecasting, planning, organising, directing, coordinating and controlling of all activities relating to acquisition and application of the financial resources of an undertaking in keeping with its financial objective. Financial Management is concerned with the managerial decisions that result in the acquisition and financing of short term and long term credits for the firm.

Howard and Uptron define Financial Management "as an application of general managerial principles to the area of financial decision-making".

Weston and Brigham define Financial Management "as an area of financial decision making, harmonizing individual motives and enterprise goal".



## 6.2 OBJECTIVES

### Objective of Financial Management

Financial Management as the name suggests is management of finance. It deals with planning and mobilization of funds required by the firm. There is only one thing which matters for everyone right from the owners to the promoters and that is money. Managing of finance is nothing but managing of money.

Every activity of an organization is reflected in its financial statements. Financial Management deals with activities which have financial implications. The very objective of Financial Management is to maximize the wealth of the shareholders by maximizing the value of the firm. This prime objective of Financial Management is reflected in the EPS (Earning per Share) and the market price of its shares.

The earlier objective of profit maximization is now replaced by wealth maximization. Since profit maximization is a limited one it cannot be the sole objective of a firm. The term profit is a vague phenomenon and if given undue importance problems may arise whereas wealth maximization on the other hand overcomes the drawbacks of profit maximization. Thus the objective of Financial Management is to trade off between risk and return. The objective of Financial Management is to make efficient use of economic resources mainly capital.

The functions of Financial Management involves acquiring funds for meeting short term and long term requirements of the firm, deployment of funds, control over the use of funds and to trade-off between risk and return.

### Profit Maximization versus Wealth Maximization

Financial Management is basically concerned with procurement and use of funds. In the light of these, the main objectives of Financial Management are: -

1. Profit Maximization.
2. Wealth Maximization

#### 1. Profit maximization

Profit Maximization is the main objective of business because:

- (i) Profit acts as a measure of efficiency and
- (ii) It serves as a protection against risk.

#### Arguments in favour of Profit Maximization

- (i) When profit earning is the main aim of business the ultimate objective should be profit maximization.
- (ii) Future is uncertain. A firm should earn more and more profit to meet the future contingencies.
- (iii) The main source of finance for growth of a business is profit. Hence, profit maximization is required.
- (iv) Profit maximization is justified on the grounds of rationality as profits act as a measure of efficiency and economic prosperity.

#### Arguments against Profit Maximization

- (i) It leads to exploitation of workers and consumers.
- (ii) It ignores the risk factors associated with profit.



- (iii) Profit in itself is a vague concept and means differently to different people.
- (iv) It is narrow concept at the cost of social and moral obligations.

Thus, profit maximization as an objective of Financial Management has been considered inadequate.

## 2. Wealth Maximization

Wealth Maximization is considered as the appropriate objective of an enterprise. When the firms maximizes the stock holder's wealth, the individual stockholder can use this wealth to maximize his individual utility. Wealth Maximization is the single substitute for a stock holder's utility.

### A Stock holder's wealth is shown by

Stock holder's wealth = No. of shares owned x Current stock price per share  
Higher the stock price per share, the greater will be the stock holder's wealth.

### Arguments in favour of Wealth Maximization

- (i) Due to wealth maximization, the short term money lenders get their payments in time.
- (ii) The long time lenders too get a fixed rate of interest on their investments.
- (iii) The employees share in the wealth gets increased.
- (iv) The various resources are put to economical and efficient use.

### Argument against Wealth Maximization

- (i) It is socially undesirable.
- (ii) It is not a descriptive idea.
- (iii) Only stock holders wealth maximization does not lead to firm's wealth maximization.
- (iv) The objective of wealth maximization is endangered when ownership and management are separated.

In spite of the arguments against wealth maximization, it is the most appropriate objective of a firm.

## 6.3 SCOPE OF FINANCIAL MANAGEMENT

Financial Management today covers the entire gamut of activities and functions given below. The head of finance is considered to be importantly of the CEO in most organizations and performs a strategic role. His responsibilities include:

- (i) Estimating the total requirements of funds for a given period;
- (ii) Raising funds through various sources, both national and international, keeping in mind the cost effectiveness;
- (iii) Investing the funds in both long term as well as short term capital needs;
- (iv) Funding day-to-day working capital requirements of business;
- (v) Collecting on time from debtors and paying to creditors on time;
- (vi) Managing funds and treasury operations;

- (vii) Ensuring a satisfactory return to all the stake holders;
- (viii) Paying interest on borrowings;
- (ix) Repaying lenders on due dates;
- (x) Maximizing the wealth of the shareholders over the long term;
- (xi) Interfacing with the capital markets;
- (xii) Awareness to all the latest developments in the financial markets;
- (xiii) Increasing the firm's competitive financial strength in the market &
- (xiv) Adhering to the requirements of corporate governance.

The above aspects of Financial Management are covered in greater details under different chapters. A priori definitions of the scope of Financial Management fall into three groups. One view is that finance is concerned with cash. At the other extreme is the relatively narrow definition that Financial Management is concerned with raising and administering funds for an enterprise. The third approach is that it is an integral part of overall management rather than a staff specially concerned with fund raising operations. In this connection, Ezra Solomon says that in this broader view, the central issue of financial policy is the wise use of funds. One apparently straight forward approach is to define the scope of Financial Management as something which embraces those areas in which the finance officer or treasurer operates. The trouble with this empirical definition is that the responsibilities carried out by company treasurers vary quite widely from one organization to another.

### Financial Management plays two basic roles

- To participate in the process of putting funds to work within the business and to control their productivity; and
- To identify the need for funds and select sources from which they may be obtained.

### Relationship of finance with other business functions

Business function means functional activities that an enterprise undertakes in achieving its desired objectives. These functions may be classified on the basis of its operational activities.

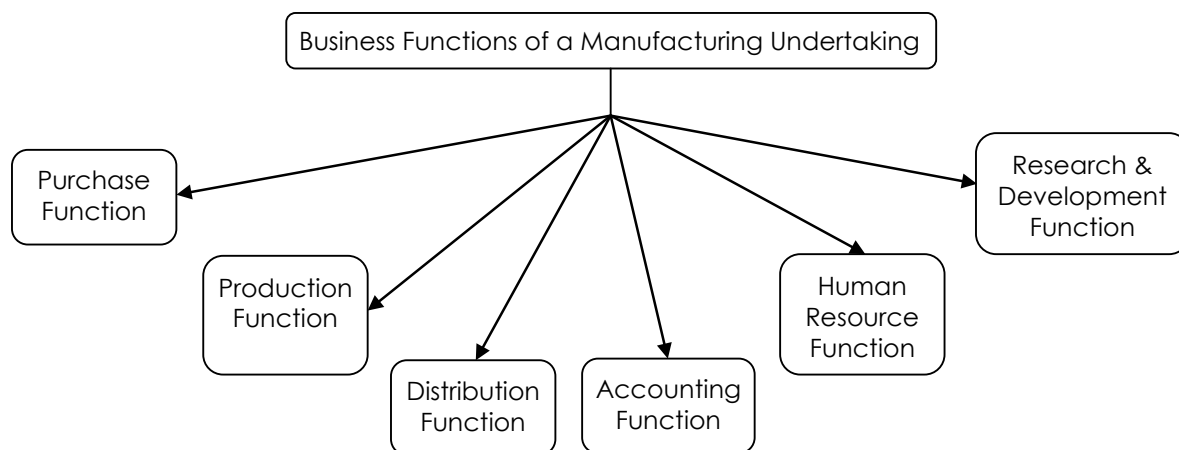



## 1. Purchase Function

In this function Finance Manager plays a key role in providing finance. In order to minimize cost and exercise maximum control, various material management techniques such as economic order quantity (EOQ), determination of stock level, perpetual inventory system etc. are applied. The task of the Finance Manager is to arrange the availability of cash when the bills for purchase become due.

## 2. Production Function

Production function involves heavy investment in fixed assets and in working capital. Naturally, a tighter control by the Finance Manager on the investment in productive assets becomes necessary. It must be seen that there is neither over-capitalisation nor under-capitalisation. Cost-benefit criteria should be the prime guide in allocating funds and therefore finance and production manager should work in unison.

## 3. Distribution Function

The objective of distribution function is making available the goods to the end customer. As every aspect of distributor function involves cash outflow and every distributing activity is aimed at bringing about inflow of cash, both the functions are closely inter-related and hence should be carried out in close union.

## 4. Accounting Function

The efficiency of the whole organization can be greatly improved with correct recording of financial data. All the accounting tools and control devices, necessary for appraisal of finance policy can be correctly formulated if the accounting data are properly recorded. For example, the cost of raising funds, expected returns on the investment of such funds, liquidity position, forecasting of sales, etc. can be effectively carried out if the financial data so recorded are reliable. Hence, the relationship between accounting and finance is intimate and the Finance Manager has to depend heavily on the accuracy of the accounting data.

## 5. Human Resource Function

A sound HR policy includes proper wage structure, incentives schemes, promotional opportunity, human resource development and other fringe benefits provided to the employees. All these matters affect finance. But the finance manager should know that organization can afford to pay only what it can bear. It means that expenditure incurred on HR Management and the expected return on such investment through labour productivity should be considered in framing a sound HR policy. Therefore, the relation between the finance and HR department should be intimate.

## 6. Research and Development Function

In the world of innovations a constant endeavour for improvement and sophistication of an existing product and introduction of newer varieties, the firm is bound to be gradually out marketed and out of existence. However, sometimes expenditure on R and D involves a heavier amount, disproportionate to the financial capacity of the firm. In such a case, it financially cripples the enterprise and the expenditure ultimately ends in a fiasco. On the other hand, cutting down of research expenditure blocks the scope of improvement and diversification of the product. Usually, this balance is struck out by joint efforts of Finance Manager and the person in charge of R and D.

## Key Decisions of Financial Management

The modern approach to the Financial Management is concerned with the solution of major problems like investment financing and dividend decisions of the financial operations of a business enterprise. Thus, the functions of Financial Management can be broadly classified into three major decisions, namely:

- (a) Investment decisions

- (b) Financing decisions
- (c) Dividend decisions

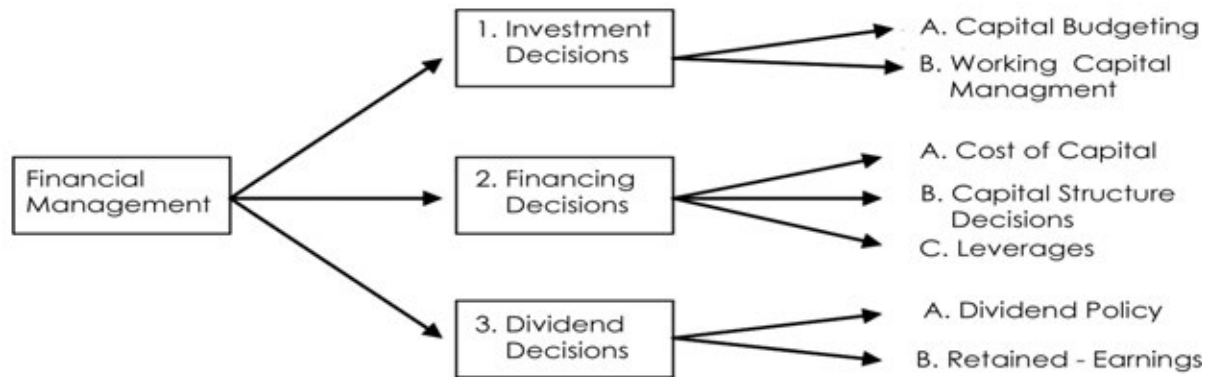

The functions of Financial Management are briefly discussed as under:

### 1. Investment Decision

The investment decision is concerned with the selection of assets in which funds will be invested by a firm. The asset of a business firm includes long term assets (fixed assets) and short term assets (current assets). Long term assets will yield a return over a period of time in future whereas short term assets are those assets which are easily convertible into cash within an accounting period i.e. a year. The long term investment decision is known as Capital Budgeting whereas the short term investment decision is identified as Working Capital Management. Capital Budgeting may be defined as long – term planning for making and financing proposed capital outlay. In other words Capital Budgeting means the long-range planning of allocation of funds among the various investment proposals. Another important element of Capital Budgeting decision is the analysis of risk and uncertainty. Since, the return on the investment proposals can be derived for a longer time in future, the Capital Budgeting decision should be evaluated in relation to the risk associated with it.

On the other hand, the Finance Manager is also responsible for the efficient management of current assets i.e. Working Capital Management. Working Capital constitutes an integral part of Financial Management. The Finance Manager has to determine the degree of liquidity that a firm should possess. There is a conflict between profitability and liquidity of a firm. Working Capital Management refers to a Trade – off between Liquidity (Risk) and Profitability. Insufficiency of funds in current assets results in – adequate liquidity and possessing of excessive funds in current assets reduces profits. Hence, the Finance Manager must achieve a proper trade – off between liquidity and profitability. In order to achieve this objective, the Finance Manager must equip himself with sound techniques of managing the current assets like cash, receivables and inventories etc.

### 2. Financing Decision

The second important decision is financing decision. The financing decision is concerned with capital – mix, (Financing – mix) or Capital Structure of a firm. The term Capital Structure refers to the proportion of debentures capital (debt) and equity share capital. Financing decision of a firm relates to the financing – mix. This must be decided taking into account the cost of capital, risk and return to the shareholders. Employment of debt capital implies a higher return to the share holders and also the financial risk. There is a conflict between return and risk in the financing decisions of a firm. So, the Finance Manager has to bring a trade – off between risk and return by maintaining a proper balance between debt capital and equity share capital. On the other hand, it is also the responsibility of the Finance Manager to determine an appropriate Capital Structure.

### 3. Dividend Decision

The third major decision is the Dividend Policy Decision. Dividend policy decisions are concerned with the distribution of profits of a firm to the shareholders. How much of the profits should be paid as dividend, i.e. dividend pay-out ratio. The decision will depend upon the preferences of the shareholder, investment opportunities available within the firm and the opportunities for future expansion of the firm. The dividend payout ratio is to be determined in the light of the objectives of maximizing the market value of the share. The dividend decisions must be analysed in relation to the financing decisions of the firm to determine the portion of retained earnings as a means of direct financing for the future expansions of the firm.

The above figure explains the bird's eye – view of Financial Management, particularly the functions of Financial Management. The three decision areas are inter related. So, the Finance Manager has to achieve an optimum combination of these functions so as to maximize wealth of shareholders and the market value of the firm. Since financing decisions of a firm are affecting other functional areas of management, it is the responsibility of the Finance Manager to see that the financial decisions must be geared to other functional areas of management like marketing, production, personnel, accounts and research and development etc.

#### FUNCTIONS OF FINANCIAL MANAGEMENT

##### Determining Financial Needs

One of the most important functions of the Finance Manager is to ensure availability of adequate financing. Financial needs have to be assessed for different purposes. Money may be required for initial promotional expenses, fixed capital and working capital needs. Promotional expenditure includes expenditure incurred in the process of company formation. Fixed assets needs depend upon the nature of the business enterprise – whether it is a manufacturing, non-manufacturing or merchandising enterprise. Current asset needs depend upon the size of the working capital required by an enterprise.

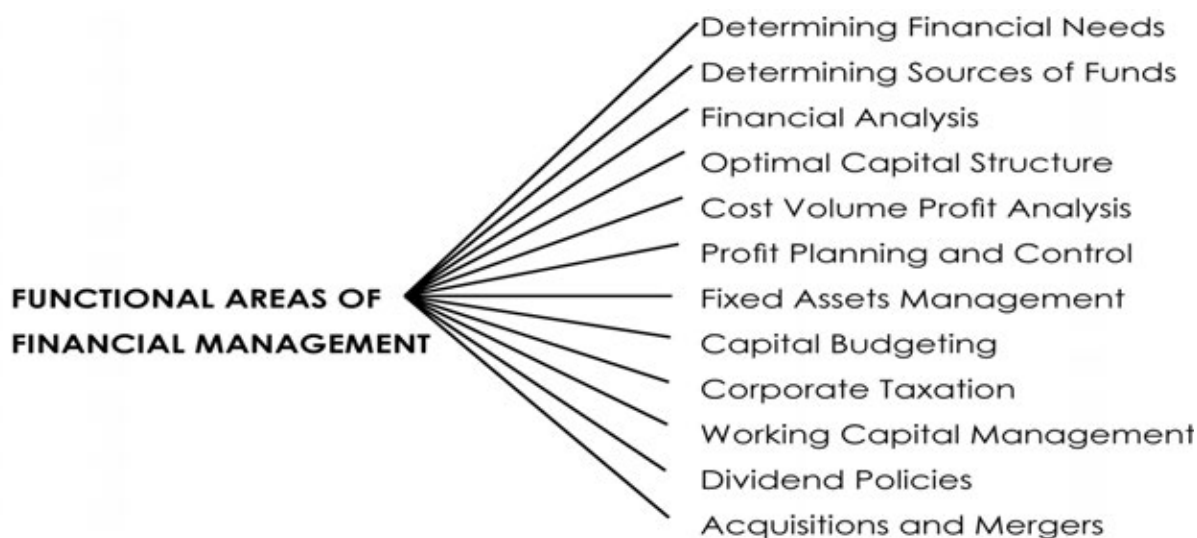

**Fig: Functional areas of Financial Management**

##### Determining Sources of Funds

The Finance Manager has to choose sources of funds. He may issue different types of securities and debentures. He may borrow from a number of financial institutions and the public. When a firm is new



and small and little known in financial circles, the Finance Manager faces a great challenge in raising funds. Even when he has a choice in selecting sources of funds, that choice should be exercised with great care and caution.

### **Financial Analysis**

The Finance Manager has to interpret different statements. He has to use a large number of ratios to analyse the financial status and activities of his firm. He is required to measure its liquidity, determine its profitability, and assets overall performance in financial terms. The Finance Manager should be crystal clear in his mind about the purposes for which liquidity, profitability and performance are to be measured.

### **Optimal Capital Structure**

The Finance Manager has to establish an optimum capital structure and ensure the maximum rate of return on investment. The ratio between equity and other liabilities carrying fixed charges has to be defined. In the process, he has to consider the operating and financial leverages of his firm. The operating leverage exists because of operating expenses, while financial leverage exists because of the amount of debt involved in a firm's capital structure.

### **Cost-Volume-Profit Analysis**

The Finance Manager has to ensure that the income of the firm should cover its variable costs. Moreover, a firm will have to generate an adequate income to cover its fixed costs as well. The Finance Manager has to find out the break-even-point-that is, the point at which total costs are matched by total sales or total revenue. He has to try to shift the activity of the firm as far as possible from the break-even point to ensure company's survival against seasonal fluctuations.

### **Profit Planning and Control**

Profit planning ensures attainment of stability and growth. Profit planning and control is a dual function which enables management to determine costs it has incurred, and revenues it has earned, during a particular period, and provides shareholders and potential investors with information about the earning strength of the corporation. Profit planning and control are important be, in actual practice, they are directly related to taxation. Profit planning and control are an inescapable responsibility of the management.

### **Fixed Assets Management**

Fixed assets are financed by long term funds. Finance Manager has to ensure that these assets should yield the reasonable returns proportionate to the investment. Moreover, in view of the fact that fixed assets are maintained over a long period of time, the assets exposed to changes in their value, and these changes may adversely affect the position of a firm.

### **Capital Budgeting**

Capital Budgeting forecasts returns on proposed long-term investments and compares profitability of different investments and their Cost of Capital. It results in capital expenditure investment. The various proposal assets ranked on the basis of such criteria as urgency, liquidity, profitability and risk sensitivity. The financial analyser should be thoroughly familiar with such financial techniques as pay back, internal rate of return, discounted cash flow and net present value among others because risk increases when investment is stretched over a long period of time. The financial analyst should be able to blend risk with returns so as to get current evaluation of potential investments.

### **Corporate Taxation**

Corporate Taxation is an important function of the Financial Management, for the former has a serious impact on the financial planning of a firm. Since the corporation is a separate legal entity, it is subject to an income-tax structure which is distinct from that which is applied to personal income.





## Working Capital Management

Working Capital is the excess of current assets over current liabilities. This is an important area in the Financial Management because it is compared to the nervous system of the human body. Current Assets consist of cash, inventory, receivables. Current Liabilities consist of payables and bank overdraft. A prudent Finance Manager has to formulate a policy in such a way that there is a balance between profitability and liquidity.

## Dividend Policies

A firm may try to improve its internal financing so that it may avail itself of benefits of future expansion. However, the interests of a firm and its stockholders are complementary, for the Financial Management is interested in maximizing the value of the firm, and the real interest of stockholders always lies in the maximization of this value of the firm; and this is the ultimate goal of Financial Management. The dividend policy of a firm depends on a number of financial considerations, the most critical among them being profitability. Thus, there are different dividend policy patterns which a firm may choose to adopt, depending upon their suitability for the firm and its stockholders.

## Acquisitions and Mergers

Firms may expand externally through co-operative arrangements, by acquiring other concerns or by entering into Mergers. Acquisitions consist of either the purchase or lease of a smaller firm by a bigger organization. Mergers may be accomplished with a minimum cash outlay, though these involve major problems of valuation and control. The process of valuing a firm and its securities is difficult, complex and prone to errors. The Finance Manager should, therefore, go through a valuation process very carefully. The most difficult interest to value in a corporation is that of the equity stockholder because he is the residual owner.

## Role of Finance Executive

Modern financial management has come a long way from the traditional corporate finance. As the economy is opening up and global resources are being tapped, the opportunities available to finance managers virtually have no limits. A new era has emerged during the recent years for chief financial officers in different organisations to finance executive is known in different name, however their role and functions are similar that assume significance in the present day context of liberalisation, deregulation and globalisation.

The finance executive of an organisation plays an important role in the company's goals, policies, and financial success. His responsibilities include:

- (a) *Financial analysis and planning*: Determining the proper amount of funds to employ in the firm, i.e. designating the size of the firm and its rate of growth
- (b) *Investment decisions*: The efficient allocation of funds to specific assets
- (c) *Financing and capital structure decisions*: Raising funds on favourable terms as possible i.e. determining the composition of liabilities
- (d) *Management of financial resources (such as working capital)*
- (e) *Risk management*: Protecting assets.

Today's Finance team is expected to add value beyond the traditional roles of cost management, controls and acting as the conscience of the organisation. These roles are challenging enough, but today's CFO is expected to work in collaboration, by serving as the integration hub for key business processes, as a catalyst for change including business transformation, and as a consultant or trusted business advisor in helping to create sustainable growth.



## 6.4 SOURCES OF FINANCE

Business firms need finance mainly for two purposes-(a) To fund the long term decisions. (b) To meet the Working Capital requirements.

The long term decisions of a firm involve setting up of the firm, expansion, diversification, modernisation and other similar capital expenditure decisions. All these involve huge investment, the benefits of which will be usually seen only in the long term. In addition to this, they are also irreversible in nature.

Working Capital is required to support the smooth functioning of the normal business operations of a company.

### Finance needs of a Business

- (i) Long term financial needs – Required for a period exceeding 5-10 years. All fixed investments in plant, machinery, land, buildings are considered as long term financial needs.
- (ii) Medium term financial needs – Required for a period between 1 to 5 years. Identification of medium term financial needs is arbitrary. Sometimes, long term requirements for which long term funds cannot be arranged immediately may be financed from medium-term sources, thus generating medium-term financial needs.
- (iii) Short term financial needs – It is related to investment in current assets such as stock, debtors, cash etc. Investment in these assets is called Working Capital. The requirement of Working Capital depends upon a number of factors and may differ from industry to industry. They are usually required for a period upto one year.

### Financial Sources of a Business can be classified as follows:

- (i) Long term sources e.g. shares, debentures, long term loan, etc.
- (ii) Medium term sources, e.g. debentures, public deposits, bank loan/overdraft.
- (iii) Short term sources e.g., trade credit, advance from commercial banks, advances from customers etc.

Following chart will give a birds eye view of various sources of finance:-

Sl. No.	Type of Funds	Owners Funds	Borrowed Funds
1.	Long Term	(a) Equity Share Capital	(a) Debentures/Bonds.
		(b) Preference Share Capital	(b) Term Loans from institution - Rupee Loan - Foreign Currency Loan
		(c) Retained earnings (Plough back of profits)	(c) Term loan from Banks
		(d) Capital Subsidy/Incentives	(d) Venture Capital Financing
			(e) Interest free sales tax loan
			(f) Asset/Debt securitization
			(g) Euro Equity Issues
			(h) New debt Instruments



2.	Medium Term	Preference Share Capital	(a) Debentures / Bonds
			(b) Public Deposits
			(c) Loans from Financial Institutions
			(d) Loan from Commercial Banks
			(e) Lease Financing
			(f) Hire Purchase/Instalment Financing Scheme.
			(g) Euro Debt Issue
			(h) New Debt Instruments
3.	Short Term		(a) Credit from trade and expense creditors.
			- Trade Credits
			- Advances from customers
			- Short term provisions
			(b) Bank Advances
			(c) Factoring
			(d) Commercial Papers
			(e) Public deposits
			(f) Inter Corporate deposits
			(g) Short term Unsecured Debentures.
			(h) Bridge Finance
			(i) Certificate of Deposit

### 1. Equity Share Capital

Equity Share Capital is the capital invested by the owners of the company together with retained earnings from previous years not distributed as dividends. Equity Share Capital is a basic source of finance for any firm. It represents the ownership interest in the company. The characteristics of equity Share Capital are a direct consequence of its position in the company's control, income and assets. Equity Share Capital does not have any maturity and there is no compulsion to pay dividend. The Equity Share Capital provides funds, more or less, on a permanent basis. It also works as a base for creating the debt and loan capacity of the firm. The advantages and limitations of Equity Share Capital may be summarized as follows:

#### Advantages of Equity Share Financing

- (i) It is a permanent source of funds.
- (ii) The new Equity Share Capital increases the corporate flexibility for the point of view of capital structure planning.
- (iii) Equity Share Capital does not involve any mandatory payments to shareholders.
- (iv) It may be possible to make further issue of share capital by using a right offering. In general, selling right shares involves no change in the relationship between ownership and control.



### Limitations of Equity Share Financing

- (i) Cost of capital is the highest of all sources.
- (ii) Equity Share Capital has a burden of Corporate Dividend Tax on the company.
- (iii) New issue of Equity Capital may reduce the (EPS) Earning Per Share of the company.

### 2. Preference Share Capital

The Preference Share Capital is also owner's capital but has a maturity period. In India, the preference shares must be redeemed within a maximum period of 20 years from the date of issue. The rate of dividend payable on preference shares is also fixed. As against the equity share capital, the preference shares have two references: (i) Preference with respect to payment of dividend, and (ii) Preference with reference to repayment of capital in case of liquidation of company.

However, the Preference Share Capital represents an ownership interest and not a liability of the company. The preference shareholders have the right to receive dividends in priority over the equity shareholders. Indeed, it is this preference which distinguishes preference shares from equity shares. A dividend need not necessarily be paid on either type of shares. However, if the directors want to pay equity dividend, then the full dividend due on the preference shares must be paid first. Failure to meet commitment of preference dividend is not a ground for liquidation. The advantages and disadvantages of the Preference Share Capital are as follows:

#### Advantages of Preference Share Financing

- (i) The preference shares carry limited voting right though they are a part of the capital.
- (ii) The cost of capital of preference shares is less than that of equity shares.
- (iii) The preference share financing may also provide a hedge against inflation.
- (iv) A company does not face liquidation or other legal proceedings if it fails to pay the preference dividends.

#### Limitations of Preference Share Financing

- (i) The cost of capital of preference shares is higher than cost of debt.
- (ii) Non-payment of dividend may adversely affect the value of the firm.
- (iii) The compulsory redemption of preference shares after 20 years will entail a substantial cash outflow from the company.

### 3. Debentures

Debenture is an instrument containing an acknowledgement of long-term indebtedness. A bond or a debenture is the basic debt instrument which may be issued by a borrowing company for a price which may be less than, equal to or more than the face value. A debenture also carries a promise by the company to make interest payments to the debenture-holders of specified amount, at specified time and also to repay the principal amount at the end of a specified period. Since the debt instruments are issued keeping in view the need and cash flow profile of the company as well as the investor, there have been a variety of debt instruments being issued by companies in practice. In all these instruments, the basic feature of being in the nature of a loan is not dispensed with and, therefore, these instruments have some or the other common features as follows:

- (i) **Credit Instrument.** A debenture-holder is a creditor of the company and is entitled to receive payments of interest and the principal and enjoys some other rights.
- (ii) **Interest Rate.** In most of the cases, the debt securities promise a rate of interest payable periodically to the debt holders. The rate of interest is also denoted as coupon rate.



- (iii) **Collateral.** Debt issue may or may not be secured and, therefore, debentures or other such securities may be called secured debentures or unsecured debentures.
- (iv) **Maturity Date.** All debt instruments have a fixed maturity date, when these will be repaid or redeemed in the manner specified.
- (v) **Voting Rights.** As the debt holders are creditors of the company, they do not have any voting right in normal situations.
- (vi) **Face Value.** Every debt instrument has a face value as well as a maturity value.
- (vii) **Priority in Liquidation.** In case of liquidation of the company, the claim of the debt holders is settled in priority over all shareholders and, generally, other unsecured creditors also.

In practice, different types of debentures have been issued. These are:

**(a) On the basis of redemption**

- (i) Redeemable debentures
- (ii) Irredeemable debentures

**(b) On the basis of security**

- (i) Secured debenture
- (ii) Un-secured debentures

**(c) On the basis of conversion**

- (i) Convertible debentures
- (ii) Non-convertible debentures

**(d) On the basis of registration**

- (i) Registered debentures
- (ii) Bearer debentures

#### 4. Lease Financing

Leasing is an arrangement that provides a firm with the use and control over assets without buying and owning the same. It is a form of renting assets. Lease is a contract between the owner of asset (lessor) and the user of the asset called the lessee, where by the lessor gives the right to use the asset to the lease over an agreed period of time for a consideration called the lease rental. The contract is regulated by the terms and conditions of the agreement. The lessee pays the lease rent periodically to the lessor as regular fixed payments over a period of time.

##### Types of Leasing

There are two basic kinds of leases:

- (i) Operating or Service Lease
- (ii) Financial Lease

##### Operating or Service Lease

An Operating Lease is usually characterized by the following features:

- (i) It is a short term lease. The lease period in such a contract is less than the useful life of asset.
- (ii) The lease is usually cancellable at short- notice by the lessee.
- (iii) As the period of an operating lease less than the useful life of the asset, it does not necessarily amortize the original cost of the asset. The lessor has to make further leases or sell the asset to recover his cost of investment and expected rate of return.
- (iv) The lessee usually has the option of renewing the lease after the expiry of lease period.
- (v) The lessor is generally responsible for maintenance, insurance and taxes of the asset.
- (vi) As it is a short term cancellable lease, it implies higher risk to the lessor but higher lease rentals to the lessee.



Operating or service leasing is common to the equipments which require expert technical staff for maintenance and are exposed to technological developments, e.g.; computers, vehicles, data processing equipments, communications systems, etc.

Operating lessors usually limit their activities to field and engage themselves in the purchase of large number of similar types of machines or equipment. They are able to offer attractive terms to their customers because savings in maintenance costs.

### **Financial Lease**

A lease is classified as Financial Lease if it ensures the lessor for amortization of the entire cost of investment plus the expected return on capital outlay during the terms of the lease. Such a lease is usually for a longer period and non cancellable. Financial Leases are commonly used for leasing land, building, machinery and fixed equipments, etc.

A Financial Lease is usually characterized by the following features:

- (i) The present value of the total lease rentals payable during the period of the lease exceeds or is equal substantially the whole of the fair value of the leased asset. It implies that within the lease period, the lessor recovers his investment in the asset along with an acceptable rate of return.
- (ii) As compared to Operating Lease, a Financial Lease is for a longer period of time.
- (iii) It is usually non cancellable by the lessee prior to its expiration date.
- (iv) The lessee is generally responsible for the maintenance, insurance and services of the asset. However, the terms of lease agreement, in some cases may require the lessor to maintain and service the asset. Such an arrangement is called "maintenance or gross lease". But usually in an Operating Lease, it is lessee who has to pay for maintenance and service costs and such a lease is known as "net lease".
- (v) A Financial Lease usually provides the lessee an option of renewing the lease for further period at a normal rent.

### **5. Term Loans**

This is also an important source of long-term financing. There are different financial institutions (National level as well as State level) which provide financial assistance for taking up projects. Term loan, as a source of long-term finance, is discussed in detail, at a later stage in this chapter.

Sometimes, the funds are required in foreign currency to make payment for acquisition and import of plants and equipments. In 1992, the Government of India permitted Indian Companies with good track record of 3 years or more to raise funds by issue of equity/debt capital in international market. There are different means of arranging long-term finance in foreign currency.

## **INTERNATIONAL SOURCES**

### **A. Depository Receipts (DR)**

A DR means any instrument in the form of a depository receipt or certificate created by the Overseas Depository Bank outside India and issued to the non-resident investors against the issue of ordinary shares. A Depository Receipt is a negotiable instrument evidencing a fixed number of equity shares of the issuing company generally denominated in US dollars. DRs are commonly used by those companies which sell their securities in international market and expand their shareholdings abroad. These securities are listed and traded in International Stock Exchanges. These can be either American Depository Receipt (ADR) or Global Depository Receipt (GDR). ADRs are issued in case the funds are raised through retail market in United States. In case of GDR issue, the invitation to participate in the issue cannot be extended to retail US investors. As the DRs are issued in overseas capital markets, the funds to the issuer are available in foreign currency, generally in US \$.



### **Global Depository Receipt (GDR)**

A GDR is a negotiable instrument, basically a bearer instrument which is traded freely in the international market either through the stock exchange or over the counter or among Qualified International Buyers (QIB).

It is denominated in US Dollars and represents shares issued in the local currency.

#### **Characteristics**

1. The shares underlying the GDR do not carry voting rights.
2. The instruments are freely traded in the international market.
3. The investors earn fixed income by way of dividend.
4. GDRS can be converted into underlying shares, depository/custodian banks reducing the issue.

#### **The market of GDR: the GDR operates in the following way:**

1. An Indian company issues ordinary equity shares.
2. These shares are deposited with a custodian bank (mostly domestic bank)
3. The custodian bank establishes a link with a depository bank overseas.
4. The depository bank, in turn issues depository receipts in dollars.
5. Funds are raised when the foreign entities purchase those depository receipts at an agreed price.
6. The dividends on such issues are paid by the issuing company to the depository bank in local currency.
7. The depository bank converts the dividends into US Dollars at the ruling exchange rate and distributes it among the GDR holders.

#### **Advantages of GDR**

1. The Indian companies are able to tap global equity market to raise currency.
2. The exchange risk borne by the investors as payment of the dividend is made in local currency.
3. The voting rights are vested only with depository.

### **American Depository Receipt (ADR)**

The depository receipt in the US market is called ADR. ADRs are those which are issued and listed in any of the stock exchanges of US. It is an investment in the stock of non- US corporation trading in the US stock exchange.

#### **Characteristics**

1. The ADRs may or may not have voting rights.
2. The ADRs are issued in accordance with the provisions laid by SEC, USA.
3. The ADRs are bearer negotiable instrument and the holder can sell it in the market.
4. The ADRs once sold can be re- issued. The operation of ADR- similar to that of GDR-

#### **Advantages**

1. The ADRs are an easy cost effective way for individuals to hold and own shares in a foreign country.
2. They save considerable money by reducing administration cost and avoiding foreign taxes on each transaction.



## B. Foreign Currency Convertible Bonds (FCCBs)

The FCCB means bonds issued in accordance with the relevant scheme and subscribed by a non-resident in foreign currency and convertible into ordinary shares of the issuing company in any manner, either in whole or in part, on the basis of any equity related warrants attached to debt instruments. The FCCBs are unsecured, carry a fixed rate of interest and an option for conversion into a fixed number of equity shares of the issuer company. Interest and redemption price (if conversion option is not exercised) is payable in dollars. Interest rates are very low by Indian domestic standards. FCCBs are denominated in any freely convertible foreign currency.

FCCBs have been popular with issuers. Local debt markets can be restrictive in nature with comparatively short maturities and high interest rates. On the other hand, straight equity-issue may cause a dilution in earnings, and certainly a dilution in control, which many shareholders, especially major family shareholders, would find unacceptable. Thus, the low coupon security which defers shareholders dilution for several years can be alternative to an issuer. Foreign investors also prefer FCCBs because of the Dollar denominated servicing, the conversion option and the arbitrage opportunities presented by conversion of the FCCBs into equity at a discount on prevailing Indian market price.

## C. External Commercial Borrowings (ECB)

Indian promoters can also borrow directly from foreign institutions, foreign development bank, World Bank, etc. It is also known as Foreign Currency Term loans. Foreign institutions provide foreign currency loans and financial assistance towards import of plants and equipments. The interest on these loans is payable in foreign currency. On the payment date, interest amount is converted into domestic currency at the prevailing foreign exchange rate. The borrowings, repayment and interest payments can be tailor-made in view of the cash flow position of the project.

## D. Other Sources

In addition to the sources discussed above, there are some sources which may be availed by a promoter on casual basis. Some of these are:

- (a) **Deferred Credit.** Supplier of plant and equipment may provide a credit facility and the payment may be made over number of years. Interest on delayed payment is payable at agreed terms and conditions.
- (b) **Bills Discounting.** In this scheme, a bill is raised by the seller of equipment, which is accepted by the buyer/ promoter of the project. The seller realizes the sales proceeds by getting the bill discounted by a commercial bank which, in turn gets the bill rediscounted by IDBI.
- (c) **Seed Capital Assistance.** At the time of availing loan from financial institutions, the promoters have to contribute seed capital in the project. In case, the promoters do not have seed capital, they can procure the seed capital from 'Seed Capital Assistance Schemes'. Two such schemes are:
  - (i) **Risk Capital Foundation Scheme.** The scheme was promoted by IFCI to provide seed capital upto ₹ 40 lakhs to the promoters.
  - (ii) **Seed Capital Assistance Scheme.** Under this scheme, seed capital for smaller projects is provided upto ₹ 15 lakhs by IDBI directly or through other financial institutions.

## Short Term Sources of Finance/ Working Capital Margin

A project requires working capital margin to take up day-to-day operations. The working capital amount is divided into two parts - (a) Permanent Working Capital, and (b) Temporary Working Capital. The Permanent Working Capital should be financed from long-term sources and Temporary Working Capital should be financed from short term sources. Some of the short-term sources are:

### (i) Trade Credit

When a firm buys goods from another, it may not be required to pay for these goods immediately. During this period, before the payment becomes due, the purchaser has a debt outstanding to the





supplier. This debt is recorded in the buyer's balance sheet as creditors; and the corresponding account for the supplier is that of debtors. The amount of such financing depends on the volume of purchases and the payment timing. Small and new firms are usually more dependent on the trade credit, as they find it difficult to obtain funds from other sources. Trade credit may take form of open account or bills payable.

### **(ii) Accrued Expenses**

Another source of short-term financing is the accrued expenses or the outstanding expenses liabilities. The accrued expenses refer to the services availed by the firm, but the payment for which has not yet been made. It is a built-in and an automatic source of finance as most of the services, are paid only at the end of a period. The accrued expenses represent an interest free source of finance. There is no explicit or implicit cost associated with the accrued expenses and the firm can save liquidity by accruing these expenses.

### **(iii) Commercial Papers**

Commercial Paper (CP) is an unsecured promissory note issued by a firm to raise funds for a short period, generally, varying from a few days to a few months. For example, in India, the maturity period of CP varies between 15 days to 1 year. It is a money market instrument and generally purchased by Commercial Banks, money market mutual funds and other financial institutions desirous to invest their funds for a short period. As the CP is unsecured, the firms having good credit rating can only issue the CP.

The interest cost of the CP depends upon the amount involved, maturity period and the prime lending rates of Commercial Banks. The main advantage of CP is that the cost involved is lower than the prime lending rates. In addition to this cost, the borrowing firm has to bear another cost in the form of placement fees payable to the dealer of CP who arranges the sale.

#### **Issue of Commercial Papers in India**

CP was introduced as a money market instruments in India in January, 1990 with a view to enable the companies to borrow for short term. Since the CP represents an unsecured borrowing in the money market, the regulation of CP comes under the purview of the Reserve Bank of India:

- (a) CP can be issued in multiples of ₹ 5 Lakhs.
- (b) CP can be issued for a minimum duration of 15 days and maximum period of 12 months.
- (c) For issuing CP the company's net worth should be more than ₹ 4 crores.
- (d) CP can neither be redeemed before maturity nor can be extended beyond the maturity period.
- (e) CP issue requires a credit rating of P2 from CRISIL or A2 from ICRA.

### **(iv) Inter-corporate Deposits (ICDs)**

When the companies borrow funds for a short-term period, say up to six months, from other companies which have surplus liquidity for the time being it is called Inter-corporate Deposits. The ICDs are generally unsecured and are arranged by a financier. The ICDs are very common and popular in practice as these are not marred by the legal hassles. The convenience is the basic virtue of this method of financing. There is no regulation at present in India to regulate these ICDs. Moreover, these are not covered by the Section 58A of the Companies Act, 1956, as the ICDs are not for long term. The transactions in the ICD are generally not disclosed as the borrowing under the ICDs imply a liquidity shortage of the borrower. The rate of interest on ICDs varies depending upon the amount involved and the time period. The entire working of ICDs market is based upon the personal connections of the lenders, borrowers and the financiers.

### **(v) Short-term Unsecured Debentures**

Companies have raised short-term funds by the issue of unsecured debentures for periods up to 17 months and 29 days. The rate of interest on these debentures may be higher than the rate on secured



long-term debentures. It may be noted that no credit rating is required for the issue of these debentures because as per the SEBI guidelines, the credit ratings required for debentures having maturity period of 18 months or more. The use of unsecured debentures as a source of short-term financing, however, depends upon the state of capital market in the economy. During sluggish period, the companies may not be in a position to issue these debentures. Moreover, only established firms can issue these debentures as new company will not find favour from the investors. Another drawback of this source is that the company procures funds from retail investors instead of getting a lump-sum from one source only. Further, that the issue of securities in capital market is a time consuming process and the issue must be planned in a proper way.

#### **(vi) Bank Credit**

Credit facility provided by Commercial Banks to meet the short-term and working capital requirements has been important short term sources of finance in India. The bank credit, in general, is a short, term financing, say, for a year or so. This short-term financing to business firm is regarded as self-liquidating in the sense that the uses to which the borrowing firm is expected to put the funds are ordinarily expected to generate cash flows adequate to repay the loan within a year. Further, these loans are called self-liquidating because the bank's motive to provide finance is to meet the seasonal demand, e.g., to cover the seasonal increase in inventories or receivables. In principle, the bank credit is intended to carry the firm through seasonal peaks in financing need. The amount of credit extended by a bank may be referred to as a credit limit which denotes the maximum limit of loan which the firm can avail from the bank. Sometimes, the bank may approve separate limits for peak season and non-peak season.

#### **Types of Bank Credit**

In India, banks may give financial assistance in different shapes and forms. The usual form of bank credit is as follows:

1. Overdraft
2. Cash Credit
3. Bills Purchased and Bills Discounting
4. Letter of Credit
5. Working Capital Term Loan
6. Funded Interest Term Loan

#### **Venture Capital**

Venture Capital is a form of equity financing especially designed for funding high risk and high reward projects. The term 'Venture Capital' represents financial investment in a highly risky project with the objective of earning a high rate of return.

There is a common perception that Venture Capital is a means of financing high technology projects. However, Venture Capital is investment of long term financial made in:

1. Ventures promoted by technically or professionally qualified but unproven entrepreneurs, or
2. Ventures seeking to harness commercially unproven technology, or
3. High risk ventures

#### **Modes of Finance by Venture Capitalists**

##### **1. Equity**

Most of the venture capital funds provide financial support to entrepreneurs in the form of equity by financing 49% of the total equity. This is to ensure that the ownership and overall control remains with



the entrepreneur. Since there is a great uncertainty about the generation of cash inflows in the initial years, equity financing is the safest mode of financing. A debt instrument on the other hand requires periodical servicing of debt.

## 2 Conditional Loan

From a venture capitalist point of view, equity is an unsecured instrument hence a less preferable option than a secured debt instrument. A conditional loan usually involves either no interest at all or a coupon payment at nominal rate. In addition, a royalty at agreed rates payable to the lender on the sales turnover. As the units pick up in sales levels, the interest rate is increased and royalty amounts are decreased.

## 3 Convertible Loans

The convertible loan is subordinate to all other loans which may be converted into equity if interest payments are not made within agreed time limit.

### Other Financial Services

#### 1. Hire Purchase

Hire Purchase is a transaction where goods are purchased and sold on the terms that (i) payment will be made in instalments, (ii) the possession of the goods is given to the buyer immediately, (iii) the property (ownership) in the goods remains with the vendor till the last instalment is paid (iv) the seller can repossess the goods in case of default in payment of any instalment, and (v) each instalment is treated as hire charges till the last instalment is paid.

The main characteristics of a Hire Purchase agreement are as below:

- (a) The payment is to be made by the hirer (buyer) to the hiree, usually the vendor, in instalments over a specified period of time.
- (b) The possession of the goods is transferred to the buyer immediately.
- (c) The property in the goods remains with the vendor (hiree) till the last instalment is paid. The ownership passes to the buyer (hirer) when he pays all instalments.
- (d) The hiree or the vendor can repossess the goods in case of default and treat the amount received by way of instalments as hire charged for that period.
- (e) The instalments in Hire Purchase include interest as well as repayment of principal.

#### 2. Forfeiting

Forfeiting refers to the exporter relinquishing his right to a receivable due at a future date in exchange for immediate cash payment, at an agreed discount, passing all risks and responsibilities for collecting the debt to the forfeiter.

It is the discounting of international trade receivable on a 100% "Without recourse" basis. "Without recourse" means the client gets full credit protection and all the components of service, i.e., short-term finance, administration of sales ledger are available to the client.

Forfeiting transforms the supplier's credit granted to the importer into cash transaction for the exporter protecting him completely from all the risks associated with selling overseas on credit. It effectively transforms a credit sale into a cash sale.

#### Procedure

- (a) The exporter sells the goods to the importer on a deferred payment basis spread over 3-5 years.
- (b) The importer draws a series of promissory notes in favour of the exporter for the payments to be made inclusive of interest charges.

- (c) Such promissory notes are availed or guaranteed by a reputed international bank which can also be the importer's banker. (it is endorsed on the promissory note by the guaranteeing bank that it covers any default of payment of the buyer).
- (d) The exporter now sells the availed notes to a forfeiter (which may be the exporter's banker) at a discount without recourse.
- (e) The forfeiter may hold these notes till maturity or sell them to group of investors interested in taking up such high-yielding unsecured paper.

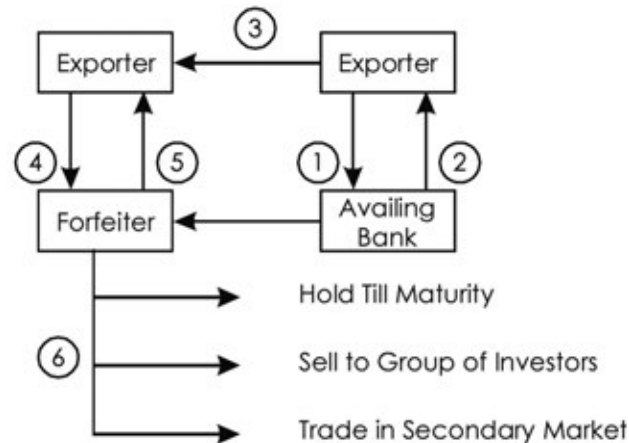

### Graphical representation of Forfeiting

1. = Promissory notes sent for availing to the importer's banker
2. = Availed notes returned to the importer
3. = Availed notes sent to exporter
4. = Availed notes sold at a discount to a forfeiter on a non - recourse basis
5. = Exporter obtains finance
6. = Forfeiter holds the notes till maturity or sells the short-term paper either to a group of investors or to investors in the secondary market.

### 3. Bill Discounting

Generally, a trade bill arises out of a genuine credit trade transaction. The supplier of goods draws a bill on the purchaser for the invoice price of the goods sold on credit. It is drawn for a short period of 3 to 6 months and in some cases for 9 months. The buyer of goods accepts the same and binds himself liable to pay the amount on the due date. In such a case, the supplier of goods has to wait for the expiry of the bill to get back the cost of the goods sold. It involves locking up of his working capital which is very much needed for the smooth running of the business or for carrying on the normal production process. It is where the Commercial Banks enter into as a financier.

The Commercial Banks provide immediate cash by discounting genuine trade bills. They deduct a certain charge as discount charges from the amount of the bill and the balance is credited to the customer's account and thus, the customer is able to enjoy credit facilities against the discounting of bills. Of course, this discount charges include interest for the unexpired period of the bill plus some service charges. Bill financing is the most liquid one from the banker's point of view since, in time of emergencies, they can take those bills to the Reserve Bank of India for rediscounting purposes. Infact, it was viewed primarily as a scheme of accommodation for banks. Now, the situation is completely changed. To-day it is viewed as a kind of loan backed by the security of bills.

#### 4. Factoring

Factoring is defined as the relationship between the seller of goods and a financial firm, called the factor, whereby the latter purchases the receivables of the former and also administers the receivable of the former. Factoring involves sale of receivable of a firm to another firm under an already existing agreement between the firm and the factor.

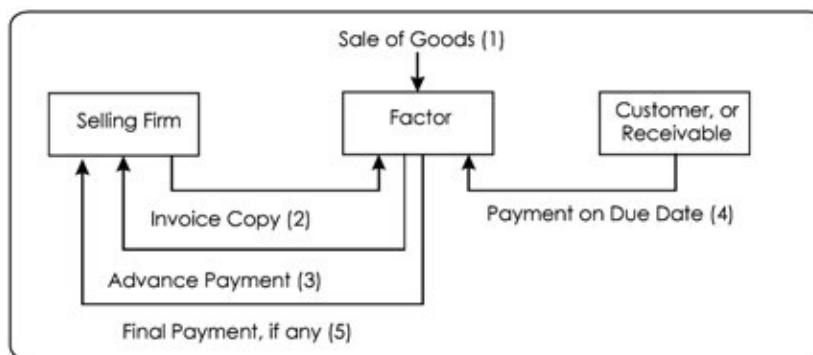

**Graphical representation of factoring**

#### Modus Operandi

A factor provides finance to his client upto a certain percentage of the unpaid invoices which represent the sale of goods or services to approved customers. The modus operandi of the factoring scheme is as follows.

- There should be a factoring arrangement (invoice purchasing arrangement) between the client (which sells goods and services to trade customers on credit) and the factor, which is the financing organization.
- Whenever the client sells goods to trade customers on credit, he prepares invoices in the usual way.
- The goods are sent to the buyers without raising a bill of exchange but accompanied by an invoice.
- The debt due by the purchaser to the client is assigned to the factor by advising the trade customers, to pay the amount due to the client, to the factor.
- The client hands over the invoices to the factor under cover of a schedule of offer along with the copies of invoices and receipted delivery challans or copies of R/R or L/R.
- The factor makes an immediate payment upto 80% of the assigned invoices and the balance 20% will be paid on realization of the debt.

#### Basic Types of Factoring

##### (i) Full Service Factoring

Under this type, a factor provides all kinds of services discussed above. Thus, a factor provides finance, administers the sales ledger, collects the debts at his risk and renders consultancy service. This type of factoring is a standard one. If the debtors fail to repay the debts, the entire responsibility falls on the shoulders of the factor since he assumes the credit risk also. He cannot pass on this responsibility to his client and, hence, this type of Factoring is also called 'Without Recourse' Factoring.



## **(ii) With Recourse Factoring or Pure Factoring**

As the very name suggests, under this type, the factor does not assume the credit risk. In other words, if the debtors do not repay their dues in time and if their debts are outstanding beyond a fixed period, say 60 to 90 days from the due date, such debts are automatically assigned back to the client. The client has to take up the work of collection of overdue account by himself. If the client wants the factor to go on with the collection work of overdue accounts, the client has to pay extra charges called 'Refactoring Charges'.

### **Benefits of Factoring**

The benefits of factoring can be summarized as follows:

#### **(i) Better Cash Flows**

The seller can offer credit to the customers, within the terms approved by the factor, and can receive prompt payments as soon as, or shortly after invoicing. This may be cheaper than financing by means of bank credit. The factoring is an alternative source of financing and can be availed if the firm expects a liquidity problem on a regular basis. In fact, the factoring ensures a definite pattern of cash inflows from the credit sales.

#### **(ii) Better Assets Management**

The security for such financial assistance is the receivable itself and, therefore, the assets will remain available as security for other borrowings.

#### **(iii) Better Working Capital Management**

Since the finance available from factoring moves directly with the level of the receivables, the problem of additional working capital required to match the sales growth does not come at all. However, a close interaction among working capital components implies that efficient management of one component can have positive benefits on other components.

#### **(iv) Better Credit Administration**

The debt management services which factors provide relieve the seller of the burden of credit administration and the seller can concentrate on the cost of staff and office space. In other words, it enables the seller to concentrate on developing his business.

#### **(v) Better Evaluation:**

The debt management service may include formal or informal advice on credit standing. Factors hold large amounts of information about the trading histories of firms. This can be valuable to those who are using factoring services and can thereby avoid doing business with customers having bad payment record.

#### **(vi) Better Risk Management**

In case of non-recourse factoring, the seller will have the advantages of repositioning the risk of customers not properly paying due bills. This will cost more than with recourse factoring and thereby allows the seller to escape the potentially dire consequences of customer's default.

### **Factoring vs. Bill Discounting**

Factoring differs from discounting in many respects. They are:

- (i) Factoring is a broader term covering the entire trade debts of a client whereas discounting covers only those trade debts which are backed by Account Receivables.
- (ii) Under factoring, the factor purchases the trade debt and thus becomes a holder for value. But, under discounting the financier acts simply as an agent of his customer and he does not become the owner. In other words, discounting is a kind of advance against bills whereas factoring is an outright purchase of trade debts.



- (iii) The factors may extend credit without any recourse to the client in the event of non-payment by customers. But, discounting is always made with recourse to the client.
- (iv) Account Receivables under discount are subject to rediscounting whereas it is not possible under factoring.
- (v) Factoring involves purchase and collection of debts, management of sales ledger, assumption of credit risk, provision of finance and rendering of consultancy services. But, discounting involves simply the provision of finance alone.
- (vi) Bill discounting finance is a specific one in the sense that it is based on an individual bill arising out of an individual transaction only. On the other hand, factoring is based on the 'whole turnover' i.e., a bulk finance is provided against a number of unpaid invoices.
- (vii) Under discounting, the drawee is always aware of the bank's charge on receivables. But, under undisclosed factoring everything is kept highly confidential.
- (viii) Bill financing through discounting requires registration of charges with the Registrar of Companies. Infact, factoring does not require such registration.
- (ix) Discounting is always a kind of "in-balance sheet financing". That is, both the amount of receivables and bank credit are shown in the balance sheet itself due to its 'with recourse' nature. But, factoring is always "off-balance sheet financing".

### **Factoring vs. Forfeiting**

Both Factoring and Forfeiting are used as tools of financing. But there are some differences:

- (i) Factoring is always used as a tool for short term financing whereas Forfeiting is for medium term financing at a fixed rate of interest.
- (ii) Factoring is generally employed to finance both the domestic and export business. But, Forfeiting is invariably employed in export business only.
- (iii) The central theme of Factoring is the purchase of the invoice of the client whereas it is only the purchase of the export bill under Forfeiting.
- (iv) Factoring is much broader in the sense it includes the administration of the sales ledger, assumption of credit risk, recovery of debts and rendering of consultancy services. On the other hand, Forfeiting mainly concentrates on financing aspects only and that too in respect of a particular export bill.
- (v) Under Factoring, the client is able to get only 80% of the total invoice as 'credit facility' whereas the 100% of the value of the export bill (of course deducting service charges) is given as credit under forfeiting.
- (vi) Forfeiting is done without recourse to the client whereas it may or may not be so under Factoring.
- (vii) The bills under Forfeiting may be held by the forfeiter till the due date or they can be sold in the secondary market or to any investor for cash. Such a possibility does not exist under Factoring.
- (viii) Forfeiting is a specific one in the sense that it is based on a single export bill arising out of an individual transaction only. But Factoring is based on the "whole turnover' i.e., a bulk finance is provided against a number of unpaid invoices.

### **5. Securitisation**

Securitisation of debt or asset refers to the process of liquidating the illiquid and long term assets like loans and receivables of financial institutions like banks by issuing marketable securities against them. In other words, debt securitization is a method of recycling of funds. It is a process whereby loans and other receivables are underwritten and sold in form of asset. It is thus a process of transforming the assets of a lending institution into negotiable instrument for generation of funds.



**Process of debt securitization:** The process of debt securitization is as follows: -

- (i) The loans are segregated into relatively homogeneous pools.
- (ii) The basis of pool is the type of credit, maturity pattern, interest rate, risk etc.
- (iii) The asset pools are then transferred to a trustee.
- (iv) The trustee then issues securities which are purchased by investors.
- (v) Such securities (asset pool) are sold on the undertaking without recourse to seller.

In this way we see that conversion of debts to securities is known as Debt Securitization.

The main advantages of securitisation are as follows:

- (i) It converts the debt into securities.
- (ii) It converts the non-liquid asset into liquid ones.
- (iii) The assets are shifted from the Balance Sheet, giving the borrower an opportunity of off balance sheet funding.
- (iv) It thus helps in better balance sheet management.
- (v) It enhances the borrower's credit rating.
- (vi) It opens up new investment avenues
- (vii) The securities are tied up in definite assets.

## 6.5 INTRODUCTION TO FINANCIAL MARKETS

A financial market is a market where financial instruments are exchanged or traded. Financial markets provide the following three major economic functions:

1. Price discovery
  2. Liquidity
  3. Reduction of transaction costs
- (1) **Price discovery** function means that transactions between buyers and sellers of financial instruments in a financial market determine the price of the traded asset. At the same time the required return from the investment of funds is determined by the participants in a financial market. The motivation for those seeking funds (deficit units) depends on the required return that investors demand. It is these functions of financial markets that signal how the funds available from those who want to lend or invest funds will be allocated among those needing funds and raise those funds by issuing financial instruments.
  - (2) **Liquidity** function provides an opportunity for investors to sell a financial instrument, since it is referred to as a measure of the ability to sell an asset at its fair market value at any time. Without liquidity, an investor would be forced to hold a financial instrument until conditions arise to sell it or the issuer is contractually obligated to pay it off. Debt instrument is liquidated when it matures, and equity instrument is until the company is either voluntarily or involuntarily liquidated. All financial markets provide some form of liquidity. However, different financial markets are characterized by the degree of liquidity.
  - (3) **Reduction of Transaction Costs:** The function of reduction of transaction costs is performed, when financial market participants are charged and/or bear the costs of trading a financial instrument. In market economics the economic rationale for the existence of institutions and instruments is related to transaction costs, thus the surviving institutions and instruments are those that have the lowest transaction costs.



### Classification of financial markets

There are different ways to classify financial markets. They are classified according to the financial instruments they are trading, features of services they provide, trading procedures, key market participants, as well as the origin of the markets.

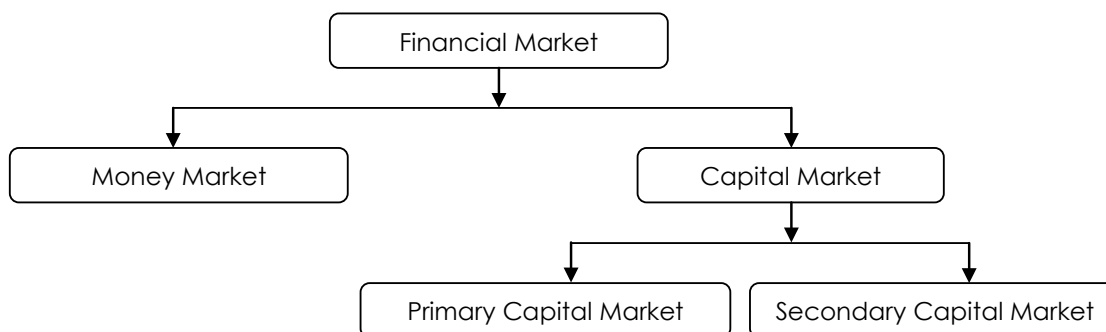

#### Money Market

Money market is the market for dealing in monetary assets of short-term nature. Short-term funds up to one year and for financial assets that are close substitutes for money are dealt in the money market. It is not a physical location (like the stock market), but an activity that is conducted over the telephone. Money market instruments have the characteristics of liquidity (quick conversion into money), minimum transaction cost and no loss in value. Excess funds are deployed in the money market, which in turn is availed of to meet temporary shortages of cash and other obligations.

Money market provides access to providers (financial and other institutions and individuals) and users (comprising institutions and government and individuals) of short-term funds to fulfil their borrowings and investment requirements at an efficient market-clearing price. The rates struck between borrowers and lenders represent an array of money market rates. The interbank overnight money rate is referred to as the call rate. There are also a number of other rates such as yields on treasury bills of varied maturities, commercial paper rate and rates offered on certificates of deposit. Money market performs the crucial role of providing an equilibrating mechanism to even out short-term liquidity and in the process, facilitating the conduct of monetary policy. Short-term surpluses and deficits are evened out. The money market is the major mechanism through which the Reserve Bank influences liquidity and the general level of interest rates. The Bank's interventions to influence liquidity serve as a signalling device for other segments of the financial system.

#### Capital Market

Capital market is divided into two parts, namely primary and secondary/stock markets. A primary capital market is where the mobilization of finance is made – from investors to corporate capital structures – by the issue of new securities – in the form of Initial Public Offering (IPO) and Follow-up Offerings (FPO) – are sold by the issuer company to the public in the primary market. The secondary capital market is known as the “aftermarket”/stock market where securities, which have been issued before, are traded. The main objective of the secondary market is to help both the buyers and sellers of securities to facilitate the transfer of security and to bring liquidity to the securities. Derivatives market is another component of capital market. Derivatives are products whose values are derived from one or more basic variables called bases. These bases can be underlying assets (forex, equity, etc.) or reference rates. Financial derivatives are divided into four categories: (i) forward contract; (ii) futures contract; (iii) options contract; and (iv) swaps contract.

### Instrument in Money Market

The instruments which are under money market are enumerated below:

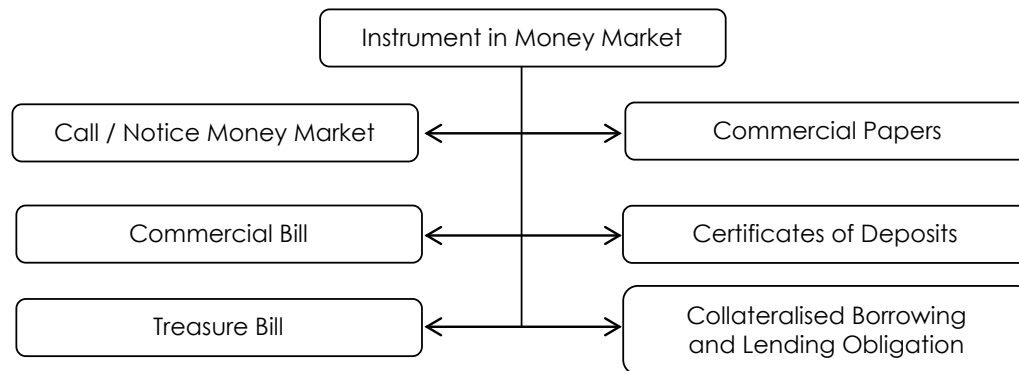

#### Call/Notice money

Call/Notice money is an amount borrowed or lent on demand for a very short period. If the period is more than one day and upto 14 days, it is called notice money and if the period is more than 14 days, it is called call money.

**Exclusions:** Intervening holidays and / or Sundays are excluded for this purpose.

No collateral security is required to cover these transactions.

#### Treasury Bills

Treasury bills are short-term instruments issued by the Reserve Bank on behalf of the government to tide over short-term liquidity shortfalls. This instrument is used by the government to raise short-term funds to bridge seasonal or temporary gaps between its receipts (revenue and capital) and expenditure. They form the most important segment of the money market not only in India but all over the world as well.

T-bills are repaid at par on maturity. The difference between the amount paid by the tenderer at the time of purchase (which is less than the face value) and the amount received on maturity represents the interest amount on T-bills and is known as the discount. Tax deducted at source (TDS) is not applicable on T-bills.

#### Commercial Bills

The working capital requirement of business firms is provided by banks through cash-credits / overdraft and purchase/discounting of commercial bills.

Commercial bill is a short term, negotiable, and self-liquidating instrument with low risk. It enhances the liability to make payment in a fixed date when goods are bought on credit. The bill of exchange is a written unconditional order signed by the drawer requiring the party to whom it is addressed to pay on demand or at a future time, a definite sum of money to the payee. It is a negotiable and self-liquidating money market instrument which evidences the liquidity to make a payment on a fixed date when goods are bought on credit. It is an asset with a high degree of liquidity and a low degree of risk. Such bills of exchange are discounted by the commercial banks to lend credit to the bill holder or to borrow from the Central bank. The bank pays an amount equal to face value of the bill minus collection charges and interest on the amount for the remaining maturity period. The writer of the bill (debtor) is drawer, who accept the bill is drawee and who gets the amount of bill is payee.

Commercial bills can be inland bills or foreign bills.



## Commercial Paper

Commercial paper (CP) is an unsecured short-term promissory note, negotiable and transferable by endorsement and delivery with a fixed maturity period. It is issued only by large, well known, creditworthy companies and is typically unsecured, issued at a discount on face value, and redeemable at its face value. The aim of its issuance is to provide liquidity or finance company's investments, e.g. in inventory and accounts receivable.

The major issuers of commercial papers are financial institutions, such as finance companies, bank holding companies, insurance companies. Financial companies tend to use CPs as a regular source of finance. Non-financial companies tend to issue CPs on an irregular basis to meet special financing needs.

Commercial paper was introduced in 1990 to enable highly rated investors to diversify their sources, of their short-term borrowings and also to produce an additional instrument in the market. Guidelines issued by RBI are applicable to issuers of CP like Non-banking finance companies and non-financial companies. Primary dealers are also permitted to issue commercial paper. CP should be issued for a minimum period of 7 days to a maximum period of one year. No grace period is allowed for payment and if the maturity date falls on a holiday it should be paid on the previous working day. Commercial paper can be permitted to be issued by the companies whose tangible net worth is not less than ₹4 crore. And fund based working capital limits are not less than ₹4 crore. It must be a listed company on a stock exchange and should have given credit rating by CRISIL.

## Certificate of Deposits

Certificates of Deposit (CDs) - introduced since June 1989 - are unsecured, negotiable, short-term instruments in bearer form, issued by a commercial bank(s)/Financial Institution(s) at discount to face value at market rates, with maturity ranging from 15 days to one year.

Being securities in the form of promissory notes, transfer of title is easy, by endorsement and delivery. Further, they are governed by the Negotiable Instruments Act. As these certificates are the liabilities of commercial banks/financial institutions, they make sound investments.

DFHI trades in these instruments in the secondary market. The market for these instruments is not very deep, but quite often CDs are available in the secondary market. DFHI is always willing to buy these instruments thereby lending liquidity to the market.

CD is a negotiable money market instrument and issued in dematerialized form or as a Usance Promissory Note, for funds deposited at a Bank or other eligible Financial Institution for a specified time period.

## Collateralised borrowing and Lending Obligation (CBLO):

The Clearing Corporation of India Ltd. (CCIL) launched a new product- CBLO- on January 20, 2003 to provide liquidity to non-bank entities hit by restrictions on access to the call money market. CBLO is a discounted instrument available in electronic book entry for the maturity period ranging from 1 day to 19 days. The maturity period can range up to one year as per the RBI guidelines. The CBLO is an obligation by the borrower to return the borrowed money, at a specified future date, and an authority to the lender to receive money lent, at a specified future date with an option/privilege to transfer the authority to another person for value received. The eligible securities are central government securities including treasury bills with a residual maturity period of more than six months. There are no restrictions on the minimum denomination as well as lock-in period for its secondary market transactions.

Banks, Cooperative Banks, Financial Institutions, Insurance Companies, Mutual funds, and Primary Dealers who are members of negotiated dealing system (NDS) are allowed to participate in CBLO transactions. Non-members like corporate, NBFCs, pension/provident funds, and trusts are allowed to participate by obtaining associate membership to CBLO segment.

There are two types of markets available for trading in CBLO: the normal market and the auction market. Under normal market, there are two settlement cycles available to members, viz, T+0 and T+1. Normal market is available for all members including associate members. Auction market is available only to NDS members for overnight borrowing and settlement on T+0 basis. Associate members are not allowed to borrow and lend funds in auction market. Currently, the minimum order lot for auction market is fixed at ₹50 lakh and in multiples of ₹5 lakh thereof. The minimum order lot for normal market is fixed at ₹5 lakh and in multiples of ₹5 lakh thereof. Order lot refers to the minimum amount that is required to constitute a successful trade in the auction and normal market.

As the repayment of borrowing under CBLO segment is guaranteed by CCIL, all CBLO members have to maintain collateral or cash margin with the CCIL as cover. CCIL sets up borrowing limits for the members against their deposits of government securities as collaterals.

In order to increase the depth and liquidity in the CBLO market, CCIL is planning to introduce an internet-based trading platform for its CBLO product which would provide access to corporate and other non-banking entities to the institutional lending and borrowing segment of money markets.

### Instruments in Capital Market

Various instruments are discussed below:

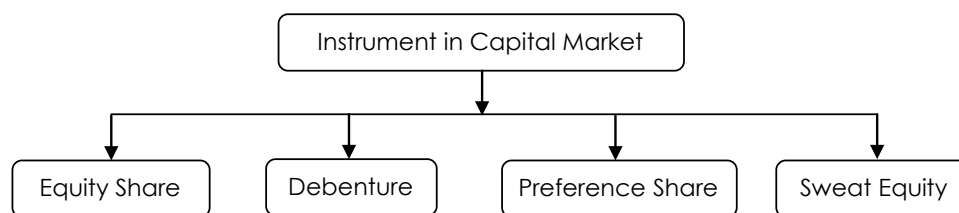

### EQUITY SHARES

An equity shareholder is the members of the company and has voting right.

As per Section 43(i) of Companies Act, 2013 "equity share capital", with reference to any company limited by shares, means all share capital which is not preference share capital. Section 43 further provides for equity share capital (i) with voting rights, or (ii) with differential rights as to dividend, voting or otherwise in accordance with such rules as may be prescribed.

### DEBENTURES

As per Section 2(30) of the Companies Act, 2013 "Debenture" includes debenture stock, bonds or any other instrument of a company evidencing a debt, whether constituting a charge on the assets of the company or not; Debenture is a document evidencing a debt or acknowledging it and any document which fulfils either of these conditions is a debenture.

### PREFERENCE SHARES

As per Section 43(ii) of Companies Act, 2013 "preference share capital", with reference to any company limited by shares, means that part of the issued share capital of the company which carries or would carry a preferential right with respect to –

- (i) payment of dividend, either as a fixed amount or an amount calculated at a fixed rate, which may either be free of or subject to income-tax; and
- (ii) repayment, in the case of a winding up or repayment of capital, of the amount of the share capital paid up or deemed to have been paid-up, whether or not, there is a preferential right to the payment of any fixed premium or premium on any fixed scale, specified in the memorandum or articles of the company



- (iii) capital shall be deemed to be preference capital, notwithstanding that it is entitled to either or both of the following rights, namely:-
- (a) that in respect of dividends, in addition to the preferential rights to the amounts specified in sub-clause (a) of clause (ii), it has a right to participate, whether fully or to a limited extent, with capital not entitled to the preferential right aforesaid;
  - (b) that in respect of capital, in addition to the preferential right to the repayment, on a winding up, of the amounts specified in sub-clause (b) of clause (ii), it has a right to participate, whether fully or to a limited extent, with capital not entitled to that preferential right in any surplus which may remain after the entire capital has been repaid.

### **Sweat Equity Shares**

As per Sec 2(88) of the companies Act 2013

“Sweat equity shares” means such equity shares as are issued by a company to its directors or employees at a discount or for consideration, other than cash, for providing their know-how or making available rights in the nature of intellectual property rights or value additions, by whatever name called.

A company may issue sweat equity shares of a class of shares already issued, if the following conditions are fulfilled:

- (a) the issue is authorised by a special resolution passed by the company;
- (b) the resolution specifies the number of shares, the current market price, consideration, if any, and the class or classes of directors or employees to whom such equity shares are to be issued;
- (c) not less than one year has, at the date of such issue, elapsed since the date on which the company had commenced business; and
- (d) where the equity shares of the company are listed on a recognised stock exchange, the sweat equity shares are issued in accordance with the regulations made by the Securities and Exchange Board in this behalf and if they are not so listed, the sweat equity shares are issued in accordance with rule 8 of Companies (Share Capital and Debenture) Rules, 2014.

### **Objectives, Functions and Powers of SEBI**

The overall objective of the SEBI, as enshrined in the preamble of the SEBI Act, 1992 is “to protect the interests of investors in securities and to promote the development of, and to regulate the securities market and for matters connected therewith or incidental thereto”.

To carry out its objectives, the SEBI performs the following functions:-

- (i) Regulate the business in stock exchanges and other securities markets;
- (ii) Registering and regulating the working of stock brokers, sub-brokers, share transfer agents, bankers to an issue, merchant bankers, underwriters, portfolio managers, investment advisor and such other intermediaries who be associated with the securities market in any manner;
- (iii) Registering and regulating the working of depositories, custodians of securities, FII, credit rating schemes, including mutual funds;
- (iv) Promoting and regulating Self-Regulatory Organisations (SROs);
- (v) Prohibiting fraudulent and unfair trade practices relating to the securities market;
- (vi) Prohibiting investors' education and training of intermediaries in securities market;
- (vii) Prohibiting substantial acquisition of shares and takeovers of companies;
- (viii) Regulating substantial acquisition of shares and takeovers of companies;



- (ix) Calling for information from, undertaking inspection, conducting inquiries and audits of the stock exchanges and intermediaries and self-regulatory organizations in the securities market;
- (x) Performing such functions and exercising such powers under the Securities Contract (Regulation) Act, 1956 as may be delegated to it by the Central Government;
- (xi) Levying fees or other charges for carrying out its work;
- (xii) Conducting research for the above purposes;
- (xiii) Performing such other functions that may be prescribed ;
- (xiv) Powers to call for periodical return from any recognized stock exchange.

### **Regulatory Requirements in Formulation of Financial Strategies**

The two major regulatory authorities are the Reserve Bank of India (RBI) and the Securities Exchange Board of India (SEBI). The regulations in the Companies Act, Income Tax Act etc. are more for governance and compliance than for strategy. RBI mainly regulates the commercial banks which in turn may influence the policies of a company. Some of the situations a Finance Manager has to face, which requires regulatory compliance are:

#### **1. Raising finance through IPO or SPO:**

IPO refers to Initial Public Offering; the first time a company comes to public to raise money. SPO refers to Seasonal Public Offering, the second and subsequent time a company raises money from the public directly. There are regulatory guidelines prescribed by SEBI regarding the entire process of going public which includes disclosure to public regarding the potential use of the cash, financial projections and percentage of shares offered to various stakeholders etc. Similarly, every time a company wants to access the capital market, either for raising finance through debt or equity, these regulatory compliances have to be met where Finance Manager will play a key role in providing the necessary information both at the time of raising resources and also at regular intervals subsequently thereafter.

#### **2. Capital Structure Changes**

Today, companies are permitted to buy their own shares. The Finance Manager, sometimes, for strategic reasons, decides to reduce the equity capital. This is technically known as Capital Reduction, which again requires regulatory compliances prescribed by SEBI and Companies Act.

#### **3. Credit Rating**

Whenever a company wants to raise money through debt, or through a new instrument, the instrument has to be rated by a credit rating agency like CRISIL, ICRA etc. as per the SEBI guidelines. Similarly, a company also has to be rated. The whole exercise of initiating the rating process providing the relevant information and answering the queries of the rating agencies will be the responsibility of the CFO.

#### **4. Foreign Exchange Transactions**

A company needs foreign exchange for a variety of reasons like importing equipment, setting up of foreign offices, travel of sales and other company employees etc. Similarly, a company may receive remittances of foreign exchange for exports made. In either of these situations, the rules and regulations relating to foreign exchange transactions needs to be complied with by the Finance Manager, on behalf of the organization. It involves some fling of returns in the prescribed format.

#### **5. Derivative Transactions**

Whenever a company uses derivatives for hedging, there are accounting and disclosure requirements to be complied with as per Companies Act & GAAP Accounting, Accounting Standards of ICAI and the International Accounting Standards. For example, Hedge Accounting has to be maintained and Profits/Losses due to Hedging should be reported.



## Foreign Exchange Management Act (FEMA)

While obtaining finance from foreign sources, Finance Manager must keep in mind the provisions relating to FEMA must be observed. A special attention must be made in dealing with the Current Account, Capital Account and Fixed Assets purchase transactions. A strict adherence to the provisions of Section 3 to 8 of the FEMA is mandatory. Similarly while doing international trade (import or export) regulations relating to Customs Act also to be adhered.

In addition to the above mentioned Acts other legislations like Income Tax Act, Goods and Services Tax Acts and Industrial Development and Regulation Act etc., to be adhered.

## Time Value of Money

Money has time value. A rupee today is more valuable than a rupee a year hence. Why? There are several reasons:

- Individuals, in general, prefer current consumption to future consumption.
- Capital can be employed productively to generate positive returns. An investments of one rupee today would grow to  $(1+r)$  a year hence ( $r$  is the rate of return earned on the investments).
- In an inflationary period a rupee today represents a greater real Purchasing Power than a rupee a year hence.

Money of the financial problems involves cash flows occurring at different points of the time. For evaluating such cash flows an explicit consideration of the Time Value of money is required. This chapter discusses the methods for dealing with the time value of money. These methods have application in various areas of financial analysis.

## Methods of Time Value of Money

- **Compounding:** We find the Future Values (FV) of all the cash flows at the end of the time period at a given rate of interest.
- **Discounting:** We determine the Time Value of money at time "O" by comparing the initial outflow with the sum of the Present Values (PV) of the future inflows at a given rate of interest.

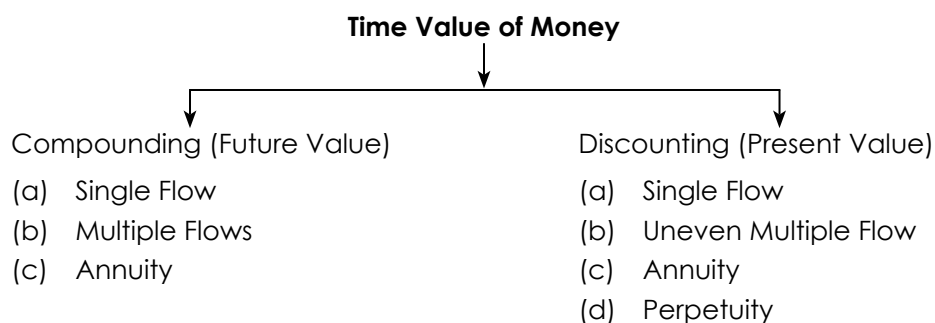

## FUTURE VALUE

### (A) Future value of a Single Flow

Suppose you have ₹ 1,000 today and you deposit it with a financial institution, This pays 10 percent interest compounded annually, for a period of 3 years. The deposit would grow as follows:

First year	Principal at the beginning	₹ 1,000
	Interest for the year ( $₹ 1,000 \times 0.10$ )	100
	Principal at the end	1,100



Second year	Principal at the beginning	₹ 1,100
	Interest for the year (₹ 1,100 × 0.10)	110
	Principal at the end	1,210
Third year	Principal at the beginning	₹ 1,210
	Interest for the year (₹ 1,210 × 0.10)	121
	Principal at the end	1,331

Principle at the end Formula: The general formula for the value of single flow as:

$$S = p (1+i)^n$$

Where  $S$  = Future value  $n$  years hence,

$p$  = Amount invested today,

$i$  = Interest rate per period, and

$n$  = Number of periods of investments.

### (B) Future value of an Annuity

An annuity is a series of periodic cash flows (payments or receipts) of equal amounts. The premium of a life insurance policy, for example, is an annuity. When the cash flows occur at the end of each period the annuity is called a regular annuity or a deferred annuity. When the cash flows occur at the beginning of each period the annuity is called an annuity due. Our discussion here will focus on a regular annuity –the formula of course, can be applied, with some modification, to an annuity due.

Suppose you deposit ₹ 1,000 in a bank for 5 years and your deposit earn a compounded interest rate of 10 percent. What will be the value of this series of deposits (an annuity) at the end of 5 years? Assuming that each deposit occurs at the end of the year, the future value of this annuity will be:

The time line for this annuity is shown:

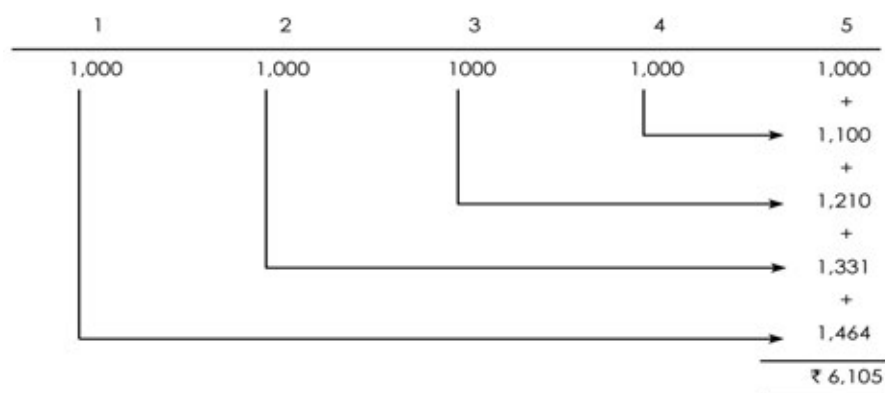

Value of annuity is given by the following formula:

$$S_n = R \left[ \frac{(1+i)^n - 1}{i} \right]$$

Where  $S_n$  = Future value of an annuity which has a duration of  $n$  periods

$R$  = Constant periodical payment,

$i$  = Interest rate per period, and

$n$  = Duration of annuity.





## PRESENT VALUE

### (A) Present value of a Single Flow

Suppose someone promise to give you ₹ 1,000 three years hence. What is the present value of this amount if the interest rate is 10 percent? The present value can be calculated by discounting ₹ 1,000, to the present point of time, as follows:

$$\text{Value of three years hence} = ₹ 1,000$$

$$\text{Value two years hence} = ₹ 1,000 \left( \frac{1}{1+0.10} \right)$$

$$\text{Value one year hence} = ₹ 1,000 \times \frac{1}{(1+0.10)^2}$$

$$\text{Value now (present value)} = ₹ 1,000 \times \frac{1}{(1+0.10)^3}$$

Formula The process of discounting, used for finding present value, is simply the reverse of compounding. The present value formula can be readily obtained by manipulating the compounding formula:

$$S = p (1+i)^n$$

Dividing both sides of above Eq. by  $(1+i)^n$  we get

$$P = S \times \frac{1}{(1+i)^n} = S \times \frac{1}{(1+i)^n}$$

$\frac{1}{(1+i)^n}$  in above equation called the discounting factor or the present value interest (PVIF<sub>i,n</sub>).

The value of PVIF<sub>i,n</sub>

for several combinations of  $i$  and  $n$ .

**Example:** Find the present value of ₹ 1,000 receivable 6 years hence if the rate of discount is 10 percent.

$$₹ 1,000 \times \text{PVIF}_{10\%, 6} = ₹ 1,000 \times 0.5645 = ₹ 564.5$$

**Example:** Find the present value of ₹ 1000 receivable 20 years hence if the discount rate is 8 percent. We obtain the answer as follows:

$$\begin{aligned} ₹ 1,000 \times \left( \frac{1}{1.08} \right)^{20} &= ₹ 1,000 \times \left( \frac{1}{1.08} \right)^{10} \times \left( \frac{1}{1.08} \right)^{10} \\ &= ₹ 1,000 \times \text{PVIF}_{8\%, 10} \times \text{PVIF}_{8\%, 10} \\ &= (1,000 \times 0.463 \times 0.463) \\ &= ₹ 214 \end{aligned}$$

### (B) Present Value of an Annuity

Suppose you expect to receive ₹ 1000 annually for 3 years - each receipt occurring at the end of the year. What is the present value of this stream of benefits if the discount rate is 10 percent? The present value of this annuity is simply the sum of the present values of all the inflows of this annuity:



$$₹ \left[ 1,000 \times \frac{1}{(1.10)} + 1,000 \times \frac{1}{(1.10)^2} + 1,000 \times \frac{1}{(1.10)^3} \right]$$

$$= ₹ 1,000 \times 0.9091 + ₹ 1,000 \times 0.8264 + ₹ 1,000 \times 0.7513 = ₹ 2,486.70$$

Formula in general terms the present value of an annuity may be expressed as:

$$S = A \left[ \frac{1 - (1+i)^{-n}}{i} \right]$$

S = Present value of an annuity

A = Amount of each instalment

i = Interest rate per period

n = Number of periods.

Where

$p_n$  = present value of an annuity which has a duration of n periods,

R = constants periodic flow, and

i = interest (discount) rate.

### Period required for doubling the amount

A common question which arises among the investors is that how much period will it take for the amount invested to be doubled at a given rate of interest.

For the explanation of this, **Rule of "72"**, is to be applied. It is a short cut way. Under this rule, the period within which the amount will be doubled is obtained by **dividing 72 by the rate of interest**.

For instance, if the rate of interest is 6%, Then its double period is  $72/6 = 12$  years.

However, an accurate way of calculating the doubling period is the **Rule of "69"**. Under this Rule, doubling period

$$= 0.35 + \frac{69}{\text{Interest Rate}}$$

Then the doubling period for the above e.g., = 11.85 years

### Illustration 1

A Person is required to pay annual payments of ₹ 8,000 in his Deposit Account that pays 10% interest per year. Find out the future value of annuity at the end of 5 years.

#### Solution:

At the end of	Amount Deposited	Term of the deposit (Years)	Future Value (₹)
1st year	8,000	4	$8,000 \times 1.464 = 11,713$
2nd year	8,000	3	$8,000 \times 1.331 = 10,648$
3rd year	8,000	2	$8,000 \times 1.210 = 9,680$
4th year	8,000	1	$8,000 \times 1.110 = 8,800$
5th year	8,000	-	$8,000 \times 1.000 = 8,000$
Future Value of annuity at the end of 5 years			48,841



Alternatively the future of annuity can be obtained by using the following formula

$$FVA = A \left[ \frac{(1+i)^n - 1}{i} \right]$$

Where

A = Annual Payment

i = Interest Rate

n = No. of years

$$8,000 \left[ \frac{(1+0.10)^5 - 1}{0.10} \right]$$

$$= 8,000 \times 6.1051 = ₹ 48,841$$

Future Value of Annuity at the end of 5 years = ₹ 48,841.

### Illustration 2

Ascertain the future value and compound interest of an amount of ₹75,000 at 8% compounded semi annually for 5 years.

#### Solution:

Amount Invested = ₹ 75,000

Rate of Interest = 8%

No. of Compounds =  $2 \times 5 = 10$  times

Rate of Interest for half year =  $\frac{8}{2} = 4\%$

Compound Value or Future Value =  $p (1+i)^n$

Where

p = Principle Amount

i = Rate of Interest (in the given case half year interest)

n = No. of years (no. of compounds)

$$= 75,000 (1+4\%)^{10}$$

$$= 75,000 \times 1.4802$$

$$= ₹ 1,11,018$$

Compound Value = 1,11,018

Compound Interest = Compound Value – Principle Amount

$$= ₹ 1,11,018 - ₹ 75,000$$

$$= ₹ 36,018.$$



## GLOSSARY

**Bank Credit:** Bank Credit is a credit facility provided by commercial banks to meet the short-term and working capital requirements.

**Bills Discounting:** Bills discounting is a scheme whereby a bill is raised by the seller of equipment, which is accepted by the buyer/ promoter of the project. The seller realizes the sales proceeds by getting the bill discounted by a commercial bank which, in turn gets the bill rediscounted by IDBI.

**Call/Notice Money:** Call/Notice Money is an amount borrowed or lent on demand for a very short period. If the period is more than one day and upto 14 days, it is called notice money and if the period is more than 14 days, it is called call money.

**Capital Market:** A primary capital market is where the mobilization of finance is made – from investors to corporate capital structures – by the issue of new securities in the form of Initial Public Offering (IPO) and Follow-up Offerings (FPO). The secondary capital market is a stock market where securities, which have been issued before, are traded.

**Certificate of Deposits:** Certificates of Deposit (CDs) are unsecured, negotiable, short-term instruments in bearer form, issued by a commercial bank(s)/Financial Institution(s) at discount to face value at market rates, with maturity ranging from 15 days to one year.

**Collateralised borrowing and Lending Obligation (CBLO):** The CBLO is an obligation by the borrower to return the borrowed money, at a specified future date, and an authority to the lender to receive money lent, at a specified future date with an option/privilege to transfer the authority to another person for value received.

**Commercial Bills:** Commercial Bill of exchange is a written unconditional order signed by the drawer requiring the party to whom it is addressed to pay on demand or at a future time, a definite sum of money to the payee. It is a negotiable and self-liquidating money market instrument which evidences the liquidity to make a payment on a fixed date when goods are bought on credit.

**Commercial Paper:** Commercial Paper (CP) is an unsecured short-term promissory note, negotiable and transferable by endorsement and delivery with a fixed maturity period. It is typically unsecured, issued at a discount on face value, and redeemable at its face value.

**Debentures:** As per Section 2(30) of the Companies Act, 2013 "Debenture" includes debenture stock, bonds or any other instrument of a company evidencing a debt, whether constituting a charge on the assets of the company or not; Debenture is a document evidencing a debt or acknowledging it and any document which fulfils either of these conditions is a debenture.

**Deferred Credit:** Deferred Credit is an arrangement by which the supplier of plant and equipment provides a credit facility to the buyer and the payment is made over number of years.

**Depository Receipt (DR):** Depository Receipt is an instrument created by the Overseas Depository Bank outside India and issued to the non-resident investors against the issue of ordinary shares. It is a negotiable instrument evidencing a fixed number of equity shares of the issuing company generally denominated in US dollars.

**Equity Share Capital:** Equity Share Capital is the capital invested by the owners of the company together with retained earnings from previous years not distributed as dividends.

**Equity Shares:** As per Section 43(1) of the Companies Act, 2013, equity share capital with reference to any company limited by shares, means all share capital which is not preference share capital.

**External Commercial Borrowings (ECB):** External Commercial Borrowings are the arrangements by which Indian promoters can borrow directly from foreign institutions, foreign development bank, World Bank, etc. It is also known as Foreign Currency Term loans.



**Factoring:** Factoring is defined as the relationship between the seller of goods and a financial firm, called the factor, whereby the latter purchases the receivables of the former and also administers the receivable of the former. It involves sale of receivable of a firm to another firm under an already existing agreement between the firm and the factor.

**Financial Management:** Financial Management comprises of forecasting, planning, organising, directing, coordinating and controlling of all activities relating to acquisition and application of the financial resources of an undertaking in keeping with its financial objective. Financial Management is concerned with the managerial decisions that result in the acquisition and financing of short term and long term credits for the firm.

**Financial Market:** Financial Market is market where financial instruments are exchanged or traded.

**Foreign Currency Convertible Bonds (FCCBs):** Foreign Currency Convertible Bonds mean bonds issued in accordance with the relevant scheme and subscribed by a non-resident in foreign currency and convertible into ordinary shares of the issuing company in any manner, either in whole or in part, on the basis of any equity related warrants attached to debt instruments.

**Forfeiting:** Forfeiting refers to the exporter relinquishing his right to a receivable due at a future date in exchange for immediate cash payment, at an agreed discount, passing all risks and responsibilities for collecting the debt to the forfeiter.

**Global Depository Receipt (GDR):** Global Depository Receipt is a negotiable instrument, a bearer instrument which is traded freely in the international market either through the stock exchange or over the counter or among Qualified International Buyers (QIB).

**Hire Purchase:** Hire Purchase is a transaction where goods are purchased and sold on the terms that (i) payment will be made in instalments, (ii) the possession of the goods is given to the buyer immediately, (iii) the property (ownership) in the goods remains with the vendor till the last instalment is paid (iv) the seller can repossess the goods in case of default in payment of any instalment, and (v) each instalment is treated as hire charges till the last instalment is paid.

**Inter-corporate Deposit (ICD):** Inter-corporate Deposit is an arrangement whereby the companies borrow funds for a short-term period, say up to six months, from other companies which have surplus liquidity for the time being.

**Lease Financing:** Lease Financing is an arrangement that provides a firm with the use and control over assets without buying and owning the same. It is a form of renting assets.

**Money Market:** Money Market is financial market for trading securities bearing short-term maturity.

**Preference Shares:** As per Section 43(2) of the Companies Act, 2013, preference share capital with reference to any company limited by shares, means that part of the issued share capital of the company which carries or would carry a preferential right with respect to –

- (i) Payment of dividend, either as a fixed amount or an amount calculated at a fixed rate, which may either be free of or subject to income-tax; and
- (ii) Repayment, in the case of a winding up or repayment of capital, of the amount of the share capital paid up or deemed to have been paid-up, whether or not, there is a preferential right to the payment of any fixed premium or premium on any fixed scale, specified in the memorandum or articles of the company.

**Securitisation:** Securitisation of debt or asset refers to the process of liquidating the illiquid and long term assets like loans and receivables of financial institutions like banks by issuing marketable securities against them. It is a method of recycling of funds.



**Sweat Equity Shares:** As per Sec 2(88) of the companies Act 2013, Sweat equity shares means such equity shares as are issued by a company to its directors or employees at a discount or for consideration, other than cash, for providing their know-how or making available rights in the nature of intellectual property rights or value additions, by whatever name called.

**Treasury Bills:** Treasury bills are short-term instruments issued by the Reserve Bank on behalf of the government to tide over short-term liquidity shortfalls in order to bridge seasonal or temporary gaps between its receipts (revenue and capital) and expenditure.

**Venture Capital:** Venture Capital is a form of equity financing especially designed for funding high risk and high reward projects. It represents financial investment in a highly risky project with the objective of earning a high rate of return.

**Self Learning Questions:**

1. Define Financial Management and state its objectives.
2. What is the scope of Financial Management?
3. Explain the functions of Financial Management.
4. Briefly explain the Short Term Sources of Finance?
5. What are the various Long Term Sources of Finance?
6. What are the various methods of computing Time Value of Money?
7. Write short notes on:
  - (a) Operating Lease Vs. Financial Lease.
  - (b) Factoring Vs. Bill Discounting.
  - (c) Factoring Vs. Forfeiting
  - (d) Venture Capital
  - (e) Global Depository Receipts (GDR)
  - (f) Commercial Paper
8. Ascertain the future value of ₹ 70,000 at 8% computed semi annually for 5 years.
9. Ascertain the computed interest of a ₹ 60,000 at 6% computed semi annually for 5 years.
10. Explain "Wealth maximisation" and "Profit maximisation" objectives of financial management.

[Ans: [8] ₹ 1,03,617 [9] ₹ 20,635]



**Multiple Choice Questions:**

1. Management of all matters related to an organisation's finances is called:
  - (a) Cash inflows and outflows
  - (b) Allocation of resources
  - (c) Financial management
  - (d) Finance.
  
2. The most important goal of financial management is:
  - (a) Profit maximisation
  - (b) Matching income and expenditure
  - (c) Using business assets effectively
  - (d) Wealth maximisation.
  
3. To achieve wealth maximization, the finance manager is supposed to take careful decision in respect of:
  - (a) Investment
  - (b) Financing
  - (c) Dividend
  - (d) All of the above.
  
4. Which of the following are microeconomic variables that help define and explain the discipline of finance?
  - (a) Risk and return
  - (b) Capital structure
  - (c) Inflation
  - (d) All of the above.
  
5. Equity shares :
  - (a) Have an unlimited life, and voting rights and receive dividends
  - (b) Have a limited life, with no voting rights but receive dividends
  - (c) Have a limited life, and voting rights and receive dividends
  - (d) Have an unlimited life, and voting rights but receive no dividends
  
6. Preference shares:
  - (a) Do not get dividends
  - (b) Have no voting rights
  - (c) Are not part of a company's share capital
  - (d) Receive dividends



7. A debenture:
  - (a) Is a long-term loan
  - (b) Does not require security
  - (c) Is a short-term loan
  - (d) Receives dividend payments
  
8. Debt capital refers to:
  - (a) Money raised through the sale of shares.
  - (b) Funds raised by borrowing that must be repaid.
  - (c) Factoring accounts receivable
  - (d) Inventory loans
  
9. The most popular source of short-term funding is:
  - (a) Factoring
  - (b) Trade credit
  - (c) Family and friends
  - (d) Commercial banks





# Study Note - 7

## TOOLS FOR FINANCIAL ANALYSIS AND PLANNING



### This Study Note includes

- 7.1 Financial Ratio Analysis
- 7.2 Fund Flow Analysis
- 7.3 Cash Flow Analysis

### 7.1 FINANCIAL RATIO ANALYSIS

Ratio analysis is the process of determining and interpreting numerical relationships based on financial statements. A ratio is a statistical yard stick that provides a measure of the relationship between variables or figures. This relationship can be expressed as percent (cost of goods sold as a percent of sales) or as a quotient (current assets as a certain number of times the current liabilities).

As ratios are simple to calculate and easy to understand there is a tendency to employ them profusely. While such statistical calculations stimulate thinking and develop understanding there is a danger of accumulation of a mass of data that obscures rather than clarifies relationships. The financial analyst has to steer a careful course. His experience and objectives of analysis help him in determining which of the ratios are more meaningful in a given situation.

The Parties Interested: The persons interested in the analysis of financial statements can be grouped under three heads:

(i) Owners or investors; (ii) Creditors; and (iii) Financial executives. Although all these three groups are interested in the financial conditions and operating results of an enterprise the primary information that each seeks to obtain from these statements is to serve. Investors desire a primary basis for estimating earning capacity. Creditors (trade and financial) are concerned primarily with liquidity and ability to pay interest and redeem loan within a specific period. Management is interested in evolving analytical tools that will measure costs, efficiency, liquidity and profitability with a view to making intelligent decisions.

#### Significance

- (i) Commercial bankers and trade creditors and the institutional lenders are mostly concerned with the ability of a borrowing enterprise to meet its financial obligations timely. As a result they are most interested in ratios like the current ratio, acid test ratio, turnover of receivables, inventory turnover, coverage of interest by level of earnings, etc.
- (ii) Long-term creditors would be interested in the working capital position of the borrower as an indication of ability to pay interest and principle in case earnings decline. So, they are interested in the ratios of total debt to equity, net worth to total assets, long-term debt to equity, long term debt to net working capital, fixed assets to networth, fixed assets to long term debt, fixed debt to capitalization etc. The number of times fixed charges are covered by earnings before interested and taxes will be of particular interest for such long-term creditors.



- (iii) Investors in shares are primarily interested in per share ratio like earnings per share, book value per share, market price per share, dividends per share, etc. They would also be interested in knowing the capitalization rate ( $E/P \text{ Ratio} = \text{Earnings per share} / \text{Price per share ratio}$ ) which is the reciprocal of P/E Ratio (Price/ Earnings ratio) and also the dividend yield, i.e.; D/P Ratio.

### Advantages of Ratio Analysis

Ratio Analysis is (useful) relevant in assessing the performance of a firm in respect of the following purposes:

- (i) **To measure the liquidity position:** The purpose of ratio analysis to measure the liquidity position of a firm. Whether the firm is able to meet its current obligations when they become due or not? A firm can be said to be liquid, if it has sufficient liquid funds to pay the interest charges on short-term debt within a year. The liquidity ratio are useful in credit analysis by banks and other financial institutions.
- (ii) **To know the solvency position:** Ratio analysis is helpful for assessing the long-term financial liability of the firm. The long term solvency is measured through the leverage, and profitability ratios. These ratios reveal the strengths and weaknesses of a firm in respect of the solvency position. The leverage ratios indicates the proportion of various sources of finance in the firms capital structure, particularly the ratio of debt and equity share capital.
- (iii) **Operating efficiency or turnover of the firm:** The ratios are helpful in measuring the operating efficiency or the turnover of the firm. These ratios indicate the efficiency in utilizing the assets of the firm such as fixed assets turnover ratio, total resources turnover ratio etc.
- (iv) **To assess the profitability position of the firm:** The ratios are useful to assess and measure the profitability of the firm in respect of sales and the investments. These ratios are concerned about the over -all profitability of the firm.
- (v) **Inter-firm and intra – firm comparison:** Ratios are not only reflects the financial position of a firm, but also serves as a tool for remedial actions. This is made possible only due to inter-firm comparison. This would demonstrate the relative position of the firm vis-à-vis its competitors. If there is any variance in the ratios either with the industry average or with, those of competitors, the firm has to identify the reasons and would take remedial measures.
- (vi) **Trend Analysis:** The trend analysis of ratios indicates whether the financial position of a firm is improving or deteriorating over the years. The significance of a trend analysis of ratio lies in the fact that the analysis can know the direction of movement whether the movement is favourable or unfavourable.

Thus, ratio analysis is considered better than a mere comparison of figures in carrying out an over - all appraisal of a company's business.

### Standards for Comparison

For making a proper use of ratios, it is essential to have fixed standards for comparison. A ratio by itself has very little meaning unless it is compared to some appropriate standard. Selection of proper standards of comparison is most important element in ratio analysis. The four most common standards used in ratio analysis in Financial Management are: absolute, historical, horizontal and budgeted.

**Absolute:** Absolute standards are those which become generally recognized as being desirable regardless of the type of company, the time, stage of business cycle and the objectives of the analyst.

**Historical:** Historical (also known as internal) standards involves comparing a company's own past performance as a standard for the present or future. But this standard may not provide a sound basis for judgment as the historical figure may not have represented an acceptable standard. It is also called as intra firm comparison.



**Horizontal:** In case of horizontal (external) standards, one company is compared with another or with the average of other companies of the same nature. It is also called as inter-firm comparison.

**Budgeted:** The budgeted standard is arrived at after preparing the budget for a period. Ratio developed from actual performance are compared to the planned ratios in the budget in order to examine the degree of accomplishment of the anticipated targets of the firm.

### Limitations of Ratio Analysis

- (i) It is always a challenging job to find an adequate standard. The conclusions drawn from the ratios can be no better than the standards against which they are compared.
- (ii) It is difficult to evaluate the differences in the factors that affect the company's performance in a particular year as compared with that of another year and that of another company. The task becomes more difficult when comparison is made of one company with another when they are of substantially different size, age and diversified products.
- (iii) While making comparisons of ratios, due allowance should be made for changes in price level. A change in price level can seriously affect the validity of comparisons of ratios computed for different time periods and particularly in case of ratios whose numerator and denominator are expressed in different units of currency.
- (iv) Comparisons are also become difficult due to differences in definition. The terms like gross profit, operating profit, net profit etc. have not got precise definitions and there is considerable diversity in practice as to how they should be measured.
- (v) A Balance Sheet may fail to reflect the average or typical situation, as it is prepared as of one moment of time. It ignores short-term fluctuations in assets and equities that may occur within the period covered by the two Balance Sheet dates.
- (vi) Various differences are found among the accounting methods used by different companies which variously affect the comparability of financial statements. Methods of recording and valuing assets, write-offs, costs, expenses etc differ from company to company.
- (vii) As ratios are simple to calculate and easy to understand, there is a tendency to over-employ them. While such statistical approach stimulates thinking, it is also likely to lead to the accumulation of a mass of data; if due care is not taken, that might obscure rather than clarify relationships.

### Sources of Financial Data for Analysis

The sources of information for financial statement analysis are:

- (a) Annual Reports
- (b) Interim financial statements
- (c) Notes to Accounts
- (d) Statement of cash flows
- (e) Business periodicals
- (f) Credit and investment advisory services

### Window Dressing

The term window dressing means manipulation of accounts in a way so as to conceal vital facts and present the financial statements in a way to show a better position than what it actually is. On account of such a situation, presence of a particular ratio may not be a definite indicator of good or bad management. For example, a high stock turnover ratio is generally considered to be an indication of operational efficiency of the business. But this might have been achieved by unwarranted price reductions or failure to maintain proper stock of goods.

Similarly, the current ratio may be improved just before the Balance Sheet date by postponing replenishment of inventory. For example, if a company has got current assets of ₹ 4,000 and current liabilities of ₹ 2,000 the current ratio is 2, which is quite satisfactory. In case the company purchases goods of ₹ 2,000 on credit, the current assets would go up to ₹ 6,000 and current liabilities to ₹ 4,000. Thus reducing the current ratio to 1.5. The company may, therefore, postpone the purchases for the early next year so that its current ratio continues to remain at 2 on the Balance Sheet date. Similarly, in order to improve the current ratio, the company may pay off certain pressing current liabilities before the Balance Sheet date. For example, if in the above case the company pays current liabilities of ₹ 1,000, the current liabilities would stand reduced to ₹ 1,000, current assets would stand reduced to ₹ 3,000 but the current ratio would go up to 3.

### Classification of Ratios

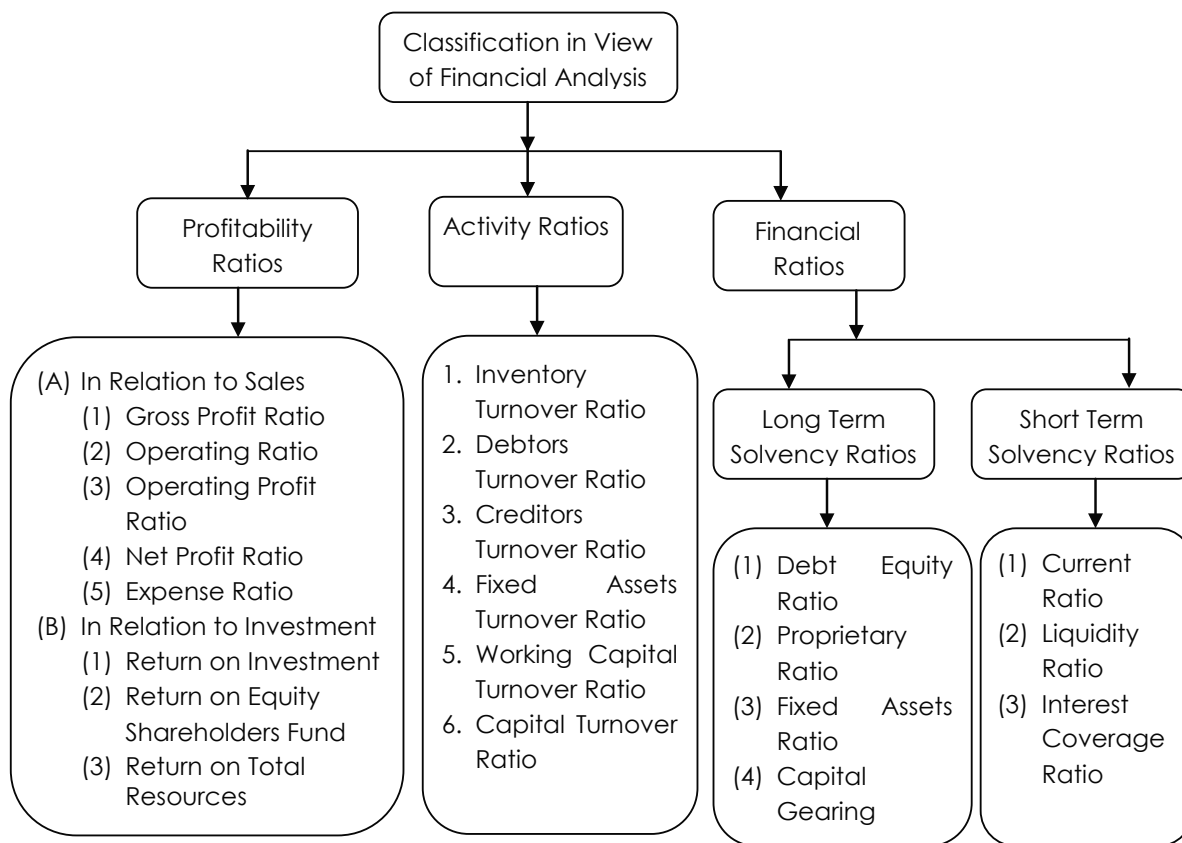

### PROFITABILITY RATIOS

These ratios give an indication of the efficiency with which the operations of business are carried on. The following are the important profitability ratios:

#### (i) Overall Profitability Ratio

This is also called as Return on Investment (ROI) or Return on Capital Employed (ROCE) ratio. It indicates the percentage of return on the total capital employed in the business. It is calculated as follows:

$$\text{ROI} = \text{Operating Profit} / \text{Capital Employed}$$

The term 'Operating Profit' means "profit before interest and tax while the term 'capital employed' refer to the sum-total of long-term funds employed in the business.



**Significance:** ROI measures the profit which a firm earns by investing a unit of capital. It is desirable to ascertain this periodically. The profit being the net result of all operations, ROI, expresses all efficiencies or inefficiencies of a business collectively. Thus, it is a dependable measure for judging the overall efficiency or inefficiency of the business.

### (ii) Price Earning Ratio (P/E Ratio)

This ratio indicates the number of times the earning per share is covered by its market price. It is calculated as follows:

$$\text{P/E Ratio} = \frac{\text{Market Price Per Equity Share}}{\text{Earning Per Share}}$$

For example, if the market price of an equity share is ₹ 20 and earnings per share is ₹ 5, the price earnings ratio will be 4 (i.e.,  $20 \div 5$ ). This means for every one rupee of earning people are prepared to pay ₹ 4. In other words, the rate of return expected by the investors is 25%

**Significance:** P/E Ratio helps the investors in deciding whether to buy or not to buy the shares of a company at a particular price. For Instance, in the example given, if the EPS falls to ₹ 3, the market price of the share should be ₹ 12 (i.e.  $3 \times 4$ ). In case the market price of the share is ₹ 15, it will not be advisable to purchase the company's shares at that price.

### (iii) Gross Profit Ratio (GPR)

This ratio expresses the relationship between Gross Profit and Net Sales. It can be computed as follows:

$$\text{GPR} = \frac{\text{Gross Profit}}{\text{Net Sales (i.e., Sales less returns)}} \times 100$$

**Significance:** The ratio indicates the overall limit within which a business must manage its operating expenses. It also helps in ascertaining whether the average percentage of mark-up on the goods is maintained.

### (iv) Net Profit Ratio (NPR)

The ratio indicates net margin earned on a sale of ₹ 100. It is calculated as follows:

$$\text{NPR} = \frac{\text{Net Profit}}{\text{Net Sales}} \times 100$$

**Significance:** The ratio helps in determining the efficiency with which the affairs of a business are being managed. Constant increase in the above ratio year after year is a definite indication of improving conditions of the business.

### (v) Operating Ratio

This ratio is a complementary of net profit ratio. In case the net profit ratio is 20%, the operating ratio will be 80%. It is calculated as follows:

$$\text{Operating Ratio} = \frac{\text{Operating Cost}}{\text{Net Sales}} \times 100$$

Operating cost includes cost of direct materials, direct labour, direct expenses and all overheads. Financial charges such as interest, provision for taxation, etc. are not to be included in operating cost.

**Significance:** The ratio is the test of the operational efficiency with which the business has carried on. The operating ratio should be low enough to leave a portion of sales for giving a fair return to the investor.

**(vi) Fixed Charges Cover Ratio (FCCR)**

The ratio indicates the number of times the fixed financial charges are covered by income before interest and tax. This ratio is calculated as follows:

$$\text{FCCR} = \frac{\text{Income before Interest and Tax}}{\text{Interest}}$$

**Significance:** The ratio is significant from the lender's point of view. It indicates whether the business would earn sufficient profits to pay periodically the interest charges. Higher the ratio, better it is.

**(vii) Pay-out Ratio**

The ratio indicates what proportion of earning per share has been used for paying dividend. It can be calculated as follows:

$$\text{Pay-Out Ratio} = \frac{\text{Dividend per equity share}}{\text{Earning per equity share}}$$

**Significance:** The ratio is an indicator of the amount of earnings that have ploughed back in the business. The lower the pay-out ratio, the higher will be the amount of earnings ploughed back in the business. A lower pay-out ratio means a stronger financial position of the company.

**(viii) Dividend Yield Ratio (DYR)**

The ratio is calculated by comparing the rate of dividend per share with its market value. It is calculated as follows:

$$\text{DYR} = \frac{\text{Dividend Per Share}}{\text{Market Price Per Share}} \times 100$$

**Significance:** The ratio helps an intending investor in knowing the effective return he is going to get on his investment. For example, if the market price of a share is ₹ 25, paid-up value is ₹ 10 and dividend rate is 20%. The dividend yield ratio is 8% (i.e.  $100 \times 2/25$ ). The intending investor can now decide whether it will be advisable for him to go for purchasing the shares of the company or not at the price prevailing in the market.

**(ix) Return on Shareholders funds or Return on Net Worth**

This ratio expresses the net profit in terms of the equity shareholders funds. This ratio calculated as follows:

$$\text{Net Worth} = \frac{\text{Net Profit after Interest \& Tax}}{\text{Net Worth}} \times 100 \quad [\text{Net Worth} = \text{Equity Capital} + \text{Reserves \& Surplus}]$$

**Significance:** This ratio is an important yardstick of performance for equity shareholders since it indicates the return on the funds employed by them.

**ACTIVITY RATIOS**

These ratios indicate the efficiency with which capital employed is rotated in the business. The various turnover ratios are as follows:

**(i) Over-all Turnover Ratio**

The ratio indicates the number of times the capital employed has been rotated in the process of doing a business. The ratio is computed as follows:

$$\text{Overall Turnover Ratio} = \frac{\text{Net Sales}}{\text{Capital Employed}}$$



**Significance:** The overall profitability of a business depends on two factors, viz., (a) the profit margin, and (b) turnover. The profit margin is disclosed by the net profit ratio while the turnover is indicated by the overall turnover ratio. A business with a lower profit margin can achieve a higher ROI if its turnover is high. This is the reason for wholesalers earning a larger return on their investment even when they have a lower profit margin. A business should not, therefore, increase its profit margin to an extent that it results in reduced turn-over resulting in reduction of overall profit.

### (ii) Fixed Assets Turnover Ratio

The ratio indicates the extent to which the investment in fixed assets has contributed towards sales. The ratio can be calculated as follows:

$$\text{Fixed Assets Turnover Ratio} = \frac{\text{Net Sales}}{\text{Net Fixed Assets}}$$

**Significance:** The comparison of fixed assets turnover ratio over a period of time indicates whether the investment in fixed assets has been judicious or not. Of course, investment in fixed assets does not push up sales immediately but the trend of increasing sales should be visible. If such trend is not visible or increase in sales has not been achieved after the expiry of a reasonable time it can be very well said that increased investments in fixed assets has not been judicious.

### (iii) Debtors' Turnover Ratio

The ratio indicates the speed with which money is collected from the debtor. It is computed as follows:

$$\text{Debtors Turnover Ratio} = \frac{\text{Credit Sales}}{\text{Average Accounts Receivable}}$$

The term average account receivable includes trade debtors and bills receivable. Average accounts receivable are computed by taking the average receivables in the beginning and at the end of the accounting year. The higher the ratio, better it is.

Debtors turnover ratio is used for computing the debt collection period. The formula for its computation is as follows:

$$\text{Debt Collection Period} = \frac{\text{Months or days in a year}}{\text{Debtors turnover ratio}} \times \frac{\text{Average Debtors}}{\text{Credit Sales}} \times 365$$

For example, if the credit sales are ₹ 80,000, average accounts receivable ₹ 20,000, the debtors' turnover ratio and debt collection period will be computed as follows:

$$\text{Debtors Turnover Ratio} = \frac{80,000}{20,000} = 4$$

$$\text{Debt Collection Period} = \frac{12 \text{ months}}{4} = 3 \text{ months}$$

This means on an average three months credit is allowed to the debtor. An increase in the credit period would result in unnecessary blockage of funds and with increased possibility of losing money due to debts becoming bad.

**Significance:** Debtors Turnover Ratio or Debt Collection Period Ratio measures the quality of debtors since it indicates the speed with which money is collected from the debtor. A shorter collection period implies prompt payment by debtors. A longer collection period implies too liberal and inefficient credit collection performance. The credit policy should neither be too liberal nor too restrictive. The former will result in more blockage of funds and bad debts while the latter will cause lower sales which will reduce profits.

**(iv) Creditors Turnover Ratio**

This is similar to Debtors Turnover Ratio. It indicates the speed with which payments for credit purchases are made to creditor it can be computed as follows:

$$\text{Creditors Turnover Period} = \frac{\text{Credit Purchases}}{\text{Average Accounts Payable}}$$

The term 'accounts payable' include trade creditors and bills payable.

From the creditors turnover, ratio, creditors payment period can be computed as follows:

$$\text{Credit Period Enjoyed} = \frac{\text{Months or days in a year}}{\text{Creditors Turnover}}$$

For example, if the credit purchases during a year are ₹1,00,000, Average accounts payable ₹ 25,000, the Creditors Turnover Ratio will be '4' (i.e., 1,00,000 / 25,000) while the creditors payment period would be 3 months (i.e., 12 months/4).

**Significance:** The creditors turnover ratio and the creditors payment period indicate about the promptness or otherwise in making payment for credit purchases. A higher creditors turnover ratio or a lower creditors payment period signifies that the creditors are being paid promptly thus enhancing the credit-worthiness of the company. However, a very favourable ratio to this effect also shows that the business is not taking full advantage of credit facilities which can be allowed by the creditors.

**(v) Stock Turnover Ratio**

The ratio indicates whether the investment in inventory is efficiently used and whether it is within proper limits. It is calculated as follows:

$$\text{Stock Turnover Ratio} = \frac{\text{Cost of Goods Sold during the year}}{\text{Average Inventory}}$$

Average inventory is calculated by taking the average of inventory at the beginning and at the end of the accounting year.

**Significance:** The ratio signifies the liquidity of inventory. A high inventory turnover ratio indicates brisk sales and vice-versa. The ratio is therefore a measure to discover possible trouble in the form of overstocking or over-valuation of inventory.

**FINANCIAL RATIOS**

They are also termed as 'Solvency Ratios'. These ratios indicate about the financial position of the company. A company is considered to be financially sound if it is in a position to carry on its business smoothly and meet all its obligations both short-term and long-term without strain. The Financial or Solvency Ratios can therefore be classified into following categories:

- (i) Long-term Solvency Ratios, which include fixed assets ratio, debt equity ratio and proprietary ratio;
- (ii) Short-term Solvency Ratios, which include current ratio, liquidity ratio, super-quick ratio and defensive interval ratio & debt service coverage ratio.

Each of these ratios are now being discussed in detail in the following pages:

**Long-term Solvency Ratios****(i) Fixed Assets Ratio:**

The ratio indicates the extent to which fixed assets have been acquired by use of long-term funds. The ratio is expressed as follows:

$$\text{Fixed Assets Ratio} = \frac{\text{Net Fixed Assets}}{\text{Long-term Funds}}$$





The term 'Net Fixed Assets' means original cost of fixed assets less depreciation to date. The ratio should not be more than '1'. The ideal ratio is 0.67.

**Significance:** It is sound principle that fixed assets should be financed out of long-term funds. As a matter of fact a part of working capital termed as core-working capital, should also be financed by long-term funds. The ratio is therefore an indication of the fact whether the company has followed sound financial policy or not. In case the ratio is more than '1', it shows that a part of working capital has also been used to acquire fixed assets, which may prove quite troublesome for the company.

### (ii) Debt-Equity Ratio

The ratio is determined to ascertain the proportion between the 'outsiders' 'funds and share-holders funds' in the capital structure of an enterprise. The term outsiders', funds is generally used to represent total long-term debt. The ratio can be computed as follows:

$$\text{Debit - Equity Ratio} = \frac{\text{Total Long-term Debt}}{\text{Shareholder's Funds}}$$

The ratio may also be calculated for ascertaining proportion of long-term debt in the total long-term funds. In such a case the ratio will be computed as follows:

$$= \frac{\text{Total Long-term Debt}}{\text{Total Long-term Funds}}$$

The ratio is considered to be ideal if the shareholders' funds are equal to total long-term debt. However, these days the ratio is also acceptable if the total long-term debt does not exceed twice of shareholders' funds.

**Significance:** The ratio is an indication of the soundness of the long-term financial policies pursued by the business enterprise. The excessive dependence on outsiders' funds may cause insolvency of the business. The ratio provides the margin of safety to the creditors. It tells the owners the extent to which they can gain by maintaining control with a limited investment.

### (iii) Proprietary Ratio

It is a variant of Debt-Equity Ratio. It establishes relationship between the proprietors' or shareholders' funds and the total tangible assets. It may be expressed as follows:

$$\text{Proprietary Ratio} = \frac{\text{Shareholder's Funds}}{\text{Total Tangible Assets}}$$

**Significance:** The ratio focuses attention on the general financial strength of the business enterprise. The ratio is of particular importance to the creditors who can find out the proportion of shareholders funds in the total assets employed in the business. A high proprietary ratio will indicate a relatively little danger to the creditors or vice-versa in the event of forced reorganization or winding up of the company.

## Short-term Solvency Ratios

### (i) Current Ratio

The ratio is an indicator of the firm's commitment to meet its short-term liabilities. It is expressed as follows:

$$\text{Current Ratio} = \frac{\text{Current Assets}}{\text{Current Liabilities}}$$

An ideal current ratio is '2'. However, a ratio of 1.5 is also acceptable if the firm has adequate arrangements with its bankers to meet its short-term requirements of funds.



**Significance:** The ratio is an index of the concern's financial stability, since, it shows the extent to which the current assets exceed its current liabilities. A higher current ratio would indicate inadequate employment of funds, while a poor current ratio is a danger signal to the management.

### (ii) Liquidity Ratio / Quick Ratio / Acid Test Ratio

The ratio is also termed as Acid Test Ratio or Quick Ratio. The ratio is ascertained by comparing the liquid assets i.e., current assets (excluding stock and prepaid expenses) to current liabilities. The ratio may be expressed as follows:

$$\text{Liquidity Ratio} = \frac{\text{Liquid Assets}}{\text{Current Liabilities}}$$

$$\text{Liquid Assets} = \text{Current Assets} - \text{Inventory} - \text{Prepaid Expenses}$$

Some accountants prefer the term liquid liabilities for current liabilities. The term 'liquid liabilities' means liabilities payable within a short period. Bank overdraft and cash credit facilities (if they become permanent modes of financing) are excluded from current liabilities for this purpose. The ratio may be expressed as follows:

$$\text{Liquidity Ratio} = \frac{\text{Liquid Assets}}{\text{Liquid Liabilities}}$$

$$\text{Liquid Liability} = \text{Current Liability} - \text{Bank Overdraft} - \text{Cash Credit}$$

The ideal ratio is '1'.

**Significance:** The ratio is an indicator of short-term solvency of the company. A comparison of the current ratio to quick ratio should also indicate the inventory hold-ups. For instance, if two units have the same current ratio but different liquidity ratios, it indicates over-stocking by the concern having low liquidity ratio as compared to the firm which has a higher liquidity ratio.

### (iii) Super-quick Ratio

It is a slight variation of quick ratio. It is calculated by comparing the super quick assets with the current liabilities (or liquid liabilities) of a firm. The ratio may be expressed as follows:

$$\text{Super-quick Ratio} = \frac{\text{Super Quick Assets}}{\text{Current Liabilities}}$$

The term 'Super-Quick Assets' means current assets excluding stock, prepaid expenses and debtors. Thus, super-quick assets comprise mainly cash, bank balance and marketable securities.

**Significance:** This ratio is the most rigorous test of a firm's liquidity position. In case the ratio is '1', it means the firm can meet its current liabilities any time.

The ratio is a conservation test and not widely used in practice.

### (iv) Defensive-Interval Ratio (DIR)

This ratio denotes the liquidity of a firm in relation to its ability to meet projected daily expenditure from operations. It can be expressed as follows:

$$\text{Defensive Interval Ratio} = \frac{\text{Liquid Assets (quick assets)}}{\text{Daily Cash requirements (Projected)}}$$



Daily cash requirements (projected) = Projected cash operating expenditure/Number of days in a year.

**Significance:** The DIR is thought by many people to be a better liquidity measure than the quick and current ratios. Because these ratios compare assets to liabilities rather than comparing assets to expenses, the DIR and current/quick ratios would give quite different results if the company had a lot of expenses, but no debt.

#### (v) Debt Service Coverage Ratio (DSCR)

This ratio indicates whether the business is earning sufficient profits to pay not only the interest charged, but also whether due of the principal amount. The ratio is calculated as follows:

$$\text{Debt Service Coverage Ratio} = \frac{\text{Profit after Taxes} + \text{Depreciation} + \text{Interest on Loan}}{\text{Interest on Loan} + \text{Loan repayment in a year}}$$

**Significance:** The ratio is the key indicator to the lender to assess the extent of ability of the borrower to service the loan in regard to timely payment of interest and repayment of loan instalment. A ratio of 2 is considered satisfactory by the financial institutions the greater debt service coverage ratio indicates the better debt servicing capacity of the organization.

### RATIOS IN DIFFERENT INDUSTRIES

#### (1) Ratios used in hotel industry:

The variety of ratios used by hotel industry which are:

- 1) Room Occupancy Ratio
- 2) Bed Occupancy Ratio
- 3) Double Occupancy Ratio
- 4) Seat Occupancy Ratios etc.

#### (2) Ratios used in transport industry:

The following important ratios are used in transport industry:

- 1) Passenger Kilometers
- 2) Seat occupancy Ratios
- 3) Operating cost per kilometer

#### (3) Bank Industry:

The following important ratios are used in Bank Industry:

- 1) Operating expenses ratios for various periods
- 2) Loans to deposits ratios
- 3) Operating income ratios for various periods

#### (4) Telecom Industry:

The following important ratios are used in telecom Industry.

- 1) Average duration of the outgoing call
- 2) Number of outgoing calls per connection
- 3) Revenue per customer

**Illustration 1**

Following is the Profit and Loss Account and Balance Sheet of PKJ Ltd. Redraft them for the purpose of analysis and calculate the following ratios:

- 1) Gross Profit Ratio
- 2) Overall Profitability Ratio
- 3) Current Ratio
- 4) Debt-Equity Ratio
- 5) Stock-Turnover Ratio
- 6) Finished goods Turnover Ratio
- 7) Liquidity ratio

<b>Dr.</b>		<b>Profit and Loss A/c</b>		<b>Cr.</b>	
<b>Particulars</b>	<b>Amount (₹)</b>	<b>Particulars</b>	<b>Amount (₹)</b>		
Opening stock of finished goods	1,00,000	Sales	10,00,000		
Opening stock of raw material	50,000	Closing stock of raw material	1,50,000		
Purchase of raw material	3,00,000	Closing stock of finished goods	1,00,000		
Direct wages	2,00,000	Profit on sale of shares	50,000		
Manufacturing Exp	1,00,000				
Administration Exp	50,000				
Selling & distribution Exp	50,000				
Loss on sale of Plant	55,000				
Interest on debentures	10,000				
Net Profit	3,85,000				
	<b>13,00,000</b>		<b>13,00,000</b>		

**Balance Sheet**

<b>Liabilities</b>	<b>Amount (₹)</b>	<b>Assets</b>	<b>Amount (₹)</b>
Equity share capital	1,00,000	Fixed assets	2,50,000
Preference share capital	1,00,000	Stock of raw material	1,50,000
Reserves	1,00,000	Stock of finished goods	1,00,000
Debentures	2,00,000	Bank balance	50,000
Sundry Creditors	1,00,000	Debtors	1,00,000
Bills Payable	50,000		
	<b>6,50,000</b>		<b>6,50,000</b>

**Solution:**

**PKJ Ltd.**  
**Income Statement** (₹)

Sales		1,000,000
(-) Cost of goods sold:		
Raw material consumed (50,000 + 3,00,000 – 1,50,000)	2,00,000	
Wages	2,00,000	
Manufacturing expenses	1,00,000	
Cost of production	5,00,000	
(+) Opening stock of finished goods	1,00,000	
(-) Closing stock of finished goods	(1,00,000)	(5,00,000)
Gross profit		5,00,000
(-) Operating expenses:		
Administrative expenses	50,000	
Selling and distribution	50,000	(1,00,000)
Operating profit		4,00,000
(+) Non operating income (Profit on Sale of Shares)		50,000
(-) Loss on sale of plant		(55,000)
EBIT		3,95,000
(-) Interest		(10,000)
EBT / Net Profit		3,85,000

**Position Statement**

	(₹)
Bank	50,000
Debtors	1,00,000
Liquid Assets	1,50,000
(+) Stock (R.M.+F.G.)	2,50,000
Current Assets	4,00,000
(-) Current liabilities (S.C.B.P.)	(1,50,000)
Working capital	2,50,000
(+) Fixed assets	2,50,000
Capital employed in business	5,00,000
(-) External liabilities	(2,00,000)
Shareholders funds	3,00,000
(-) Preference share capital	(1,00,000)
<b>Equity share capital</b>	<b>2,00,000</b>



Represented by

Equity share capital	1,00,000
(+) Reserves	1,00,000
	<b>2,00,000</b>

$$(1) \text{ Gross Profit Ratio} = \frac{\text{Gross Profit}}{\text{Sales}} \times 100 = \frac{5,00,000}{10,00,000} \times 100 = 50\%$$

$$(2) \text{ Overall Profitability Ratio} = \frac{\text{Operating Profit}}{\text{Capital Employed}} \times 100 = \frac{4,00,000}{5,00,000} \times 100 = 80\%$$

$$(3) \text{ Current Ratio} = \frac{4,00,000}{1,50,000} = 2.67 \text{ times}$$

$$(4) \text{ Debt equity Ratio} = \frac{\text{Long term debt}}{\text{Long term fund}} \times 100 = \frac{2,00,000}{5,00,000} = 0.4$$

$$(5) \text{ Stock Turnover Ratio} = \frac{\text{Raw Material Consumed}}{\text{Average Stock of raw material}} = \frac{2,00,000}{1,00,000} = 2$$

$$[\text{Average stock of Raw Material} \frac{50,000 + 1,50,000}{2} = 1,00,000]$$

$$(6) \text{ Finished Goods Turnover Ratio} = \frac{\text{COGS}}{\text{Average Stock of finished goods}} = \frac{5,00,000}{1,00,000} = 5$$

$$[\text{Average stock of Finished Goods} \frac{1,00,000 + 1,00,000}{2} = 1,00,000]$$

$$(7) \text{ Liquidity Ratio} = \frac{\text{Liquid Assets}}{\text{Liquid Liabilities}} = \frac{1,50,000}{1,50,000} = 1$$

$$\begin{aligned} \text{Liquid Assets} &= \text{Current Assets} - \text{Inventories} - \text{Prepaid Expenses} \\ &= 4,00,000 - 1,50,000 - 1,00,000 \end{aligned}$$

$$\begin{aligned} \text{Liquid Liability} &= \text{Current Liability} - \text{Bank Overdraft} - \text{Cash Credit} \\ &= 1,50,000 - 0 \\ &= ₹ 1,50,000 \end{aligned}$$

### Illustration 2

A company has a profit margin of 20% and asset turnover of 3 times. What is the company's return on investment? How will this return on investment vary if?

- Profit margin is increased by 5%?
- Asset turnover is decreased to 2 times?
- Profit margin is decreased by 5% and asset turnover is increase to 4 times?

**Solution:**

Net profit ratio	= 20% (given)
Assets turnover ratio	= 3 times (given)
Return on Investment (ROI)	= Net Profit ratio x Assets turnover ratio
	= 20% × 3 times = 60%

**(i) If net profit ratio is increased by 5%:**

Then Revised Net Profit Ratio = 20 + 5 = 25%

Asset Turnover Ratio (as before) = 3 times

∴ ROI = 25 % x 3 times = 75%

**(ii) If assets turnover ratio is decreased to 2 times:**

NP Ratio (as before) = 20%

Revised Asset Turnover Ratio = 2 times

∴ ROI = 20% × 2 times = 40%

**(iii) If net profit ratio falls by 5% and assets turnover ratio raises to 4 times:**

Then Revised NP Ratio = 20 - 5 = 15%

Revised Asset Turnover Ratio = 4 times

∴ ROI = 15% x 4 = 60%

**Illustration 3**

The following is the Balance Sheet of M/S Yamuna Enterprise for the year ended 31-12-2015:

**Balance Sheet as on 31st December, 2015**

Liabilities	Amount (₹)	Assets	Amount (₹)
Equity share capital	1,00,000	Cash in hand	2,000
12% Preference share capital	1,00,000	Cash in bank	10,000
16% Debentures	40,000	Bills Receivable	30,000
18% Public debts	20,000	Investment	20,000
Bank overdraft	40,000	Debtors	70,000
Creditors	60,000	Stock	40,000
Outstanding Creditors	7,000	Furniture	30,000
Proposed dividends	10,000	Machinery	1,00,000
Reserves	1,50,000	Land & Building	2,20,000
Provision for taxation	20,000	Goodwill	35,000
Profit & Loss Account	20,000	Preliminary expenses	10,000
	<b>5,67,000</b>		<b>5,67,000</b>



During the year provision for taxation was ₹ 20,000. Dividend was proposed at ₹ 10,000. Profit carried forward from the last year was ₹ 15,000. You are required to calculate:

- Short term solvency ratios, and
- Long term solvency ratios.

**Solution:**

Short term solvency ratios:

$$\text{Current Ratio} = \frac{\text{Current Assets}}{\text{Current Liabilities}} = \frac{1,52,000}{1,37,000} = 1.109 \text{ times}$$

$$\text{Current Assets} = 2,000 + 10,000 + 30,000 + 70,000 + 40,000 = 1,52,000$$

$$\text{Current Liabilities} = 40,000 + 60,000 + 7,000 + 10,000 + 20,000 = 1,37,000$$

The ideal ratio is 2 but in the instant case it is only 1.109. hence, it is not satisfactory.

$$\text{Liquid Ratio} = \frac{\text{Liquid Assets}}{\text{Liquid Liabilities}} = \frac{1,12,000}{97,000} = 1.155 \text{ times}$$

$$\begin{aligned} \text{Liquid Assets} &= \text{Current Assets} - \text{Inventory} \\ &= 1,52,000 - 40,000 \\ &= 1,12,000 \end{aligned}$$

$$\begin{aligned} \text{Liquid Liability} &= \text{Current Liability} - \text{Bank Overdraft} - \text{Cash Credit} \\ &= 1,37,000 - 40,000 \\ &= 97,000. \end{aligned}$$

This indicates that the company's EBIT covers 4.5 times of its interest expenses, which is quite satisfactory.

**Calculation of EBIT**

	(₹)
Profit retained	5,000
(+) Proposed dividend	10,000
PAT	15,000
(+) Tax	20,000
PBT	35,000
(+) Interest [6400 + 3600]	10,000
<b>EBIT</b>	<b>45,000</b>

$$\text{Interest} = 16\% \text{ of } 40,000 + 18\% \text{ of } 20,000 = 6400 + 3600 = 10,000$$

**Long term solvency ratios:**

$$\text{Debt Equity Ratio} = \frac{\text{Long Term Debt}}{\text{Long Term Fund}} = \frac{60,000}{3,85,000} = 0.156 \text{ times}$$



**Long term debt:**

	(₹)
Debentures	40,000
Public debt	20,000
	60,000

**Long term fund**

	(₹)
Equity Share Capital	1,00,000
Preference Share Capital	1,00,000
Debentures	40,000
Public Debts	20,000
Reserves	1,50,000
Profit and Loss Account	20,000
	4,30,000
Less: Goodwill	35,000
Preliminary Expenses	10,000
	3,85,000

<b>Share holder funds:</b>	(₹)
Equity capital	1,00,000
Preference capital	1,00,000
Reserves	1,50,000
P & L A/c	20,000
(-) Good will	35,000
(-) Preliminary exp	10,000
	3,25,000

Long term debt/ share holders funds =  $60,000 / 3,25,000 = 0.18$  times

Both are quite satisfactory.

It seems the company has adopted a conservative policy for raising finance. Under such policy the equity share holders may not avail the benefit of trading on equity.

→ Fixed Assets Ratio = Fixed Assets / Long Term Funds =  $3,50,000 / 3,85,000 = 0.91$  times

The ratio is satisfactory.

→ Proprietary Ratio Share holder Funds / Total Tangible Assets  
=  $[3,25,000 / (5,67,000 - 4,50,00)] = 0.6226$  times

Ratio is ideal. And long term position is quite satisfactory, it is advised to improve short term solvency.

**Illustration 4**

Following is the Balance Sheet of Sun Ltd., as on December 31, 2015.

Liabilities	Amount (₹)	Assets	Amount (₹)
Equity Share Capital	20,000	Goodwill	12,000
Capital Reserves	4,000	Fixed Assets	28,000
8% Loan on mortgage	16,000	Stocks	6,000
Trade creditors	8,000	Debtors	6,000
Bank over draft	2,000	Investments	2,000
Taxation:		Cash in hand	6,000
Current	2,000		
Future	2,000		
Profit & Loss A/c:			
PAT for the year			
Less: Transfer to:	12,000		
Reserves	4,000		
Dividend	2,000		
	60,000		60,000

Sales amounted to ₹1,20,000. Calculate ratio for (a) testing liquidity, and (b) testing solvency.

**Solution:****Ratios for testing liquidity**

1. Current Ratio = Current Assets/ Current Liabilities = 20,000/12,000 = 1.67 times
2. Liquidity Ratio = Liquid Assets/ Current Liabilities = 14,000/12,000 = 1.17 times

The liquid position of the company is satisfactory. Both the current ratio and liquidity ratio are satisfactory.

**Ratios for testing solvency**

1. Debt- equity Ratio = Share holders Funds/ Total Long Term Funds = 18,000/36,000 = 0.5 times
2. Fixed Assets Ratio = Net profit before interest and tax/ Interest = 14,000/1,280 = 10.94 times

All solvency ratios are very much favorable to the company judged from the above, the company has satisfactory position both from liquidity and solvency viewpoints.

**Working notes:****1. Current Assets**

	(₹)
Stock	6,000
Debtors	6,000
Investments*	2,000
Cash in hand	6,000
	20,000

\* presumed to be short- term.



## 2. Current Liabilities

	(₹)
Trade creditors	8,000
Bank overdraft	2,000
Taxation*	2,000
	12,000

\* excluding future taxation presumed to be payable after a year.

## 3. Liquid Assets

	(₹)
Current Assets	20,000
Less: Stock	6,000
	14,000

## 4. Liquid Liability

	(₹)
Current Liability	12,000
Less: Bank Overdraft	2,000
	10,000

## 5. Share holders' Funds

Equity share capital	20000	
Capital reserves	4000	
P & L accounts balance	6000	30000
Less: Goodwill		12000
		<b>18000</b>

## 6. Long Terms Funds

	(₹)
Share holders' funds	18,000
Mortgage loan	16,000
Future taxation	2,000
	36,000

## 7. Interest Calculation:

8% of 16,000 = 1,280

**Illustration 5**

With the help of the following information complete the Balance Sheet of PKJ Ltd.

Equity share capital	₹ 1,00,000
The relevant ratios of the company are as follows:	
Current debt to total debt	40
Total debt to owner's equity	60
Fixed assets to owner's equity	60
Total assets turnover	2 Times
Inventory turnover	8 Times

**Solution:**

**In the Books of PKJ Ltd.  
Balance Sheet**

Liabilities	Amount (₹)	Assets	Amount (₹)
Owners equity	1,00,000	Fixed Assets	60,000
Current debt	24,000	Cash	60,000
Long term debt	36,000	Inventory	40,000
	1,60,000		1,60,000

**Working Notes:**

- Fixed assets =  $0.60 \times \text{Owners equity} = 0.60 \times ₹ 1,00,000 = ₹ 60,000$ .
- Total debt =  $0.60 \times \text{Owners equity} = 0.60 \times ₹ 1,00,000 = ₹ 60,000$ .
- Total assets consisting of fixed assets and current assets must be equal to ₹ 1,60,000 (Assets = Liabilities + Owners equity). Since fixed assets are ₹ 60,000 hence, current assets should be ₹ 1,00,000.
- Total equity = Total debt + Owners equity = ₹ 60,000 + ₹ 1,00,000 = ₹ 1,60,000.
- Total assets turnover = 2 Times; Inventory turnover = 8 Times. Therefore, Inventory/Total assets =  $2/8 = 1/4$ ; Total assets = ₹ 1,60,000. Therefore, Inventory =  $1,60,000 / 4 = 40,000$ .
- Cash = ₹ 1,00,000 – ₹ 40,000 = ₹ 60,000.

**Illustration 6**

Using the following data, prepare the Balance Sheet:

Gross profits	₹ 54,000
Shareholders Funds	₹ 6,00,000
Gross Profit Margin	20%
Credit Sales to Total Sales	80%
Total Assets turnover	0.3 times
Inventory turnover	4 times
Average collection period (a 360 days year)	20 days
Current ratio	1.8
Long-term Debt to Equity	40%

**Solution:****Balance Sheet**

Liabilities	Amount (₹)	Assets	Amount (₹)
Creditors (bal. Fig.)	60,000	Cash	42,000
Long Term Debts	2,40,000	Debtors	12,000
Share Holders Fund	6,00,000	Inventory	54,000
		Fixed Assets (bal. fig).	7,92,000
	9,00,000		9,00,000

**Working Notes:****1. Gross Profit:**

$$\begin{aligned} \text{GP Margin} &= 20\% \\ \text{GP} &= ₹ 54,000 \\ \text{Sales} &= 54,000 / 20\% = ₹ 2,70,000 \end{aligned}$$

**2. Credit Sales:**

$$\begin{aligned} \text{Credit Sales} &= 80\% \text{ of Total Sales} \\ &= 2,70,000 \times 80\% = ₹ 2,16,000 \end{aligned}$$

**3. Total Assets:**

$$\begin{aligned} \text{Total Assets Turnover} &= \text{Sales} / \text{Total Assets} = 0.3 \text{ Times} \\ \text{Total Assets} &= 2,70,000 / 0.3 = ₹ 9,00,000 \end{aligned}$$

**4. Inventory Turnover:**

$$\begin{aligned} \text{Inventory Turnover} &= \text{Cost of Goods Sold} / \text{Inventory} \times 100 \\ &= 2,70,000 - 54,000 / \text{Inventory} \\ \text{Inventory} &= 2,16,000 / 4 = ₹ 54,000 \end{aligned}$$

**5. Debtors:**

$$\text{Debtors} = \text{Credit Sales} \times 20 / 360 \text{ days} = ₹ 12,000$$

**6. Creditors:**

$$\begin{aligned} \text{Total Assets} &= 9,00,000 \\ \text{Total of Balance Sheet} &= 9,00,000 \\ \text{Now, Long Term Debt} &= \text{Long Term Debt} / \text{Equity} = 40\% \\ \text{Long Term Debt} &= 40\% \text{ of equity} \\ &= 6,00,000 \times 40\% = ₹ 2,40,000 \end{aligned}$$

**Now Balancing figure of Liability side is creditors**

$$= 9,00,000 - 6,00,000 \text{ (Equity)} - 2,40,000 \text{ (Long Term Debt)}$$

$$= ₹ 60,000$$

$$\text{Creditors} = ₹ 60,000$$

**7. Current Ratio – Cash:**

$$\text{Current ratio} = \text{Current Assets} / \text{Current Liabilities}$$

$$1.8 = \text{Debtors} + \text{Inventory} + \text{Cash} / \text{Creditors}$$

$$1.8 = 12,000 + 54,000 + \text{Cash} / 60,000$$

$$1,08,000 = 66,000 + \text{Cash}$$

$$\text{Cash} = ₹ 42,000$$

**8. Fixed Assets:**

Balancing figure on Assets Side is Fixed Assets.

**9. Sales**

$$\text{COGS} = \text{Sales} - \text{G.P.}$$

$$\text{COGS} = ₹ 2,70,000 - 54,000 = ₹ 2,16,000$$

**Illustration 7**

PKJ Limited has the following Balance Sheets as on March 31, 2016 and March 31, 2015:

**Balance Sheet**

(₹ in Lakhs)

Particulars	March 31, 2015	March 31, 2016
<b>Source of Funds</b>		
Shareholders Funds	2,377	1,472
Loan Funds	3,570	3,083
	<b>5,947</b>	<b>4,555</b>
<b>Application of Funds</b>		
Fixed Assets	3,466	2,900
Cash and bank	489	470
Debtors	1,495	1,168
Stock	2,867	2,407
Other Current Assets	1,567	1,404
Less: Current Liabilities	(3,937)	(3,794)
	<b>5,947</b>	<b>4,555</b>

The Income Statement of the PKJ Ltd. for the year ended is as follows:

(₹ in Lakhs)

	March 31, 2015	March 31, 2016
Sales	22,165	13,882
Less: Cost of Goods sold	20,860	12,544
Gross Profit	1,305	1,338
Less: Selling, General and Administrative expenses	1,135	752
Earning before Interest and Tax (EBIT)	170	586
Less: Interest Expenses	113	105
Profits before Tax	57	481
Less: Tax	23	192
Profits after Tax (PAT)	34	289

**Required:**

- Calculate for the year 2015-16:
  - Inventory Turnover Ratio
  - Financial Leverage
  - Return on Investment (ROI)
  - Return on Equity (ROE)
  - Average Collection period.
- Give a brief comment on the Financial Position of PKJ Limited.

**Solution:**

**1. Ratios for the year 2015-16**

(a) Inventory Turnover Ratio  
 = Cost of goods sold / Average Inventory  
 = 20,860 / (2,867 + 2,407) / 2  
 = 20,860 / 2,637 = 7.910

(b) Financial Leverage

	2015-2016	2014 - 2015
= EBIT / EBT	= 170 / 57	= 586 / 481
	= 2.98	= 1.22

(c) Return on Investment

$$\text{ROI} = \text{NOPAT} / \text{Sales} \times \text{Sales} / \text{Average Capital employed}$$

$$= \frac{57 \times (1 - 0.4)}{22,165} \times \frac{22,165}{(5,947 + 4,555) / 2}$$



$$= \frac{57 \times (0.6)}{22,165} \times \frac{22,165}{5,251}$$

$$= 34.2 / 5,251$$

$$= 0.65\%$$

(d) Return on Equity

$$\text{ROE} = \text{PAT} / \text{Average share holders fund}$$

$$= 34 / [(2,377 + 1,472)] / 2)$$

$$= 34 / 1,924.5$$

$$= 1.77\%$$

(e) Average Collection Period

$$\text{Average Collection Period} = \text{Average Debtors} / \text{Average Sales per day}$$

$$= [(1,495 + 1,168) / 2] / [22,165 / 365 \text{ days}]$$

$$= 1,331.5 / 60.73 = 22 \text{ days.}$$

Financial position of PKJ Limited

A careful analysis of above Balance Sheet shows that current ratio of company is 1.5 which is less than the standard (i.e. 2) and short-term solvency ratio is therefore not satisfactory. At the same time lot of capital is blocked in inventory as compared to previous year. This affects liquidity of the firm.

As regards utilization of Debt Capital, the percentage of debts to total assets is not high, but as compared to equity, debt content is more in capital structure. Company is said to be levered with higher proportion of debt in its capital structure. This situation involves considerable risk to shareholders in capital structuring, the company should ensure that cost of debt remains lower than return on investment.

### Illustration 8

The following figures and ratios are related to a company:

(a) Sales for the year (all credit)	₹ 30,00,000
(b) Gross Profit ratio	25 per cent
(c) Fixed assets turnover (basis on cost of goods sold)	1.5
(d) Stock turnover (basis on cost of goods sold)	6
(e) Liquid ratio	1:1
(f) Current ratio	1.5 : 1
(g) Debtors collection period	2 months
(h) Reserve and surplus to share capital	0.6 : 1
(i) Capital gearing ratio	0.5
(j) Fixed assets to net worth	1.20 : 1

You are required to prepare Balance Sheet of the company on the basis of above details.



**Solution:****Preparation of Balance Sheet of a Company****Working Notes:**

1. Cost of Goods Sold = Sales – Gross Profit (=25% of Sales)  
= ₹ 30,00,000 – ₹ 7,50,000  
= ₹ 22,50,000
2. Closing Stock = Cost of Goods sold/Stock Turnover  
= ₹ 22,50,000 / 6  
= ₹ 3,75,000
3. Fixed Assets = Cost of Goods Sold / Fixed Assets Turnover  
= ₹ 22,50,000 / 1.5  
= ₹ 15,00,000
4. Current Assets: = 1.5 and Liquid Ratio = 1  
Current Ratio Stock = 1.5 – 1 = 0.5  
Current Assets = Amount of Stock x 1.5 / 0.5  
= ₹ 3,75,000 x 1.5/0.5 = ₹ 11,25,000
5. Liquid Assets (Debtors and Cash) = Current Assets – Stock  
= ₹ 11,25,000 – ₹ 3,75,000  
= ₹ 7,50,000
6. Debtors = Sales x Debtors Collection Period / 12  
= ₹ 30,00,000 x 2 / 12  
= ₹ 5,00,000
7. Cash = Liquid Assets – Debtors  
= ₹ 7,50,000 – ₹ 5,00,000  
= ₹ 2,50,000
8. Net worth = Fixed Assets / 1.2  
= ₹ 15,00,000 / 1.2  
= ₹ 12,50,000
9. Reserves and Surplus  
Reserves and Share Capital = 0.6 + 1 = 1.6  
Reserves and Surplus = ₹ 12,50,000 x 0.6 / 1.6  
= ₹ 4,68,750
10. Share capital = Net worth – Reserves and Surplus  
= ₹ 12,50,000 – ₹ 4,68,750  
= ₹ 7,81,250



$$\begin{aligned} 11. \text{ Current Liabilities} &= \text{Current Assets} / \text{Current Ratio} \\ &= ₹ 11,25,000 / 1.5 \\ &= ₹ 7,50,000 \end{aligned}$$

## 12. Long-Term Debts

$$\begin{aligned} \text{Capital Gearing Ratio} &= \text{Long-term Debts} / \text{Equity shareholder's Fund} \\ &= ₹ 12,50,000 \times 0.5 \\ &= ₹ 6,25,000 \end{aligned}$$

**Balance Sheet of a Company**

Liabilities	Amount (₹)	Assets	Amount (₹)
Equity Share Capital	7,81,250	Fixed Assets	15,00,000
Reserves and Surplus	4,68,750	Current Assets	
Long-term Debts	6,25,000	Stock	3,75,000
Current Liabilities	7,50,000	Debtors	5,00,000
		Cash	2,50,000
	<b>26,25,000</b>		<b>26,25,000</b>

**Illustration 9**

PKJ Limited has made plans for the next year 2015-16. It is estimated that the company will employ total assets of ₹ 25,00,000; 30% of assets being financed by debt at an interest cost of 9% p.a. The direct costs for the year are estimated at ₹ 15,00,000 and all other operating expenses are estimated at ₹ 2,40,000. The sales revenue are estimated at ₹ 22,50,000. Tax rate is assumed to be 40%.

Required to calculate:

- Net profit margin
- Return on Assets
- Asset turnover
- Return on equity

**Solution:**

The net profit is computed as follows:

Particulars	(₹)
Sales Revenue	22,50,000
Less: Direct Costs	15,00,000
Gross Profits	7,50,000
Less: Operating Expense	2,40,000
EBIT	5,10,000
Less: Interest (9% x 7,50,000)	67,500
EBT	4,42,500
Less: Taxes (@ 40%)	1,77,000
PAT	2,65,500



## (a) Net Profit Margin

$$\begin{aligned}\text{Net Profit Margin} &= \text{EBIT} (1-t) / \text{Sales} \times 100 \\ &= 5,10,000 \times (1 - 0.4) / 22,50,000 = 13.6\%\end{aligned}$$

## (b) Return on Assets (ROA)

$$\begin{aligned}\text{ROA} &= \text{EBIT} (1-t) / \text{Total Assets} \\ &= 5,10,000 (1 - 0.4) / 25,00,000 \\ &= 3,06,000 / 25,00,000 = 0.1224 = 12.24\%\end{aligned}$$

## (c) Asset Turnover

$$\begin{aligned}\text{Asset Turnover} &= \text{Sales} / \text{Assets} \\ &= 22,50,000 / 25,00,000 = 0.9\end{aligned}$$

## (d) Return on Equity (ROE)

$$\begin{aligned}\text{ROE} &= \text{PAT} / \text{Equity} \\ &= 2,65,500 / 17,50,000 = 15.17\%\end{aligned}$$

**Illustration 10**

With the help of the following ratios regarding Indu Films draw the Balance Sheet of the company for the year 2015:

Current Ratio	2.5
Liquidity ratio	1.5
Net working capital	₹ 3,00,000
Stock turnover ratio (cost of sales /closing stock)	6 times
Gross profit ratio	20%
Fixed Assets turnover ratio (on cost of sales)	2 times
Debt collection period	2 months
Fixed Assets to share holders net worth	0.80
Reserve and surplus to capital	0.5

**Solution:****Balance Sheet of Indu Films for the year 2015**

Liabilities	Amount (₹)	Assets	Amount (₹)
Share capital	5,00,000	Fixed assets	6,00,000
Reserve and surplus	2,50,000	Stock	2,00,000
Long-term borrowings (Bal. Fig.)	1,50,000	Debtors	2,50,000
Current liabilities	2,00,000	Bank	50,000
	11,00,000		11,00,000

**Working notes:**

If Current Liabilities	1
Current Assets	2.5
It means difference on Working Capital	1.5
Working Capital is 1.5	₹ 3,00,000
Therefore, Current Assets	₹ 5,00,000
Current Liabilities	₹ 2,00,000
As Liquidity Ratio	1.5
And Current Liabilities	₹ 2,00,000
(Bank and Debtors) (2,00,000 x 1.5)	₹ 3,00,000
Stock (5,00,000-3,00,000) i.e., Current Assets- Liquid Assets	₹ 2,00,000
Cost of sales (as stock turnover ratio is 6)	₹ 12,00,000
Sales (as G.P. ratio is 20%, $1,200,000 + \frac{20}{80} \times 1,200,000$ )	₹ 15,00,000
Fixed Assets are ₹ 1,200,000/2, since Debtors collection	
Fixed Assets Turnover Ratio is 2 times	₹ 6,00,000
Debtors are ₹ 1,500,000/6 since debtors collection period is 2 months	₹ 2,50,000
Shareholders' net worth 600,000 x 1/0.80	₹ 7,50,000
Out of shareholders' net worth Reserves and Surplus ( 7,50,000 x 0.5/1.5)	₹ 2,50,000
Therefore, Share capital	₹ 5,00,000

**7.2 FUND FLOW ANALYSIS**

The Balance Sheet provides only a static view of the business. It is a statement of assets and liabilities on a particular date. It does not show the movement of funds. In business concerns, funds flow from different sources and similarly funds are invested in various sources of investment. It is a continuous process. The study and control of this funds flow process is the main objective of Financial Management to assess the soundness and solvency of a business., financing and investing activities over the related period. Like the Balance Sheet, even the Profit and Loss Account does not depict the changes that have taken place in financial condition of a business concern between two dates. Hence there is a need to prepare an additional statement to know the changes in assets, liabilities and owners' equity between dates of two Balance Sheets. Such a statement is called Funds Flow Statement or Statement of Sources and Uses of funds or where come and where gone statement.

The Funds Flow Statement, which is also known as the Statement of Changes in financial position, is yet another tool of analysis of financial statements.

**Meaning and concepts of funds**

Funds Flow Statement is a widely used tool in the hands of financial executives for analysing the financial performance of a business concern. Funds keep on moving in a business which itself is based on a going concern concept.

The term Funds has a variety of meanings.

**In a narrow sense:** In a narrow sense fund means only cash. Funds Flow Statement prepared on this basis is called as Cash Flow Statement. In this type of statement only in flow and outflow of cash is taken into account.



**In a broader sense:** In a broader sense the term fund refers to money value in whatever form it may exist. Here funds mean all financial resources in the form of men, materials, money, machinery etc.

**Popular sense:** In a popular sense the term funds means Working Capital i.e., the excess of Current Assets over Current Liabilities. When the funds move inwards or outwards they cause a flow or rotation of funds. Here the word fund means Net Working Capital. In short, if funds mean working capital, then the statement prepared on the basis is called Funds Flow Statement.

Funds Flow Statement gives detailed analysis of changes in distribution of resources between two Balance Sheet dates. This statement is widely used by the financial analysts and credit granting institutions and Finance Managers in performing their jobs. Thus, Funds, Flow Statement, in general is able to present that information which either is not available or not readily apparent from an analysis of other financial statements.

### Definitions

A statement of sources and application of funds is a technical device designed to analyse the changes in the financial condition of a business enterprise between two dates. **- Foulke**

Funds Flow Statement describes the sources from which additional funds were derived and the use to which these sources were put. **- Anthony**

### Significance of funds flow statement

It is very useful tool in the Financial Managers analytical kit. It provides a summary of management decisions on financing activities of the firm and investment policy. The following are the advantages of Funds Flow Statement.

- (i) **Analysis of financial operations:** The Funds Flow Statement reveals the net affect of various transactions on the operational and financial position of the business concern. It determines the financial consequences of business operations. This statement discloses the causes for changes in the assets and liabilities between two different points of time. It highlights the effect of these changes on the liquidity position of the company.
- (ii) **Financial policies:** Funds Flow Statement guides the management in formulating the financial policies such as dividend, reserve etc.
- (iii) **Control device:** It serves as a measure of control to the management. If actual figures are compared with budgeted projected figures, management can take remedial action if there are any deviations.
- (iv) **Evaluation of firm's financing:** Funds Flow Statement helps in evaluating the firm's financing. It shows how the funds were obtained from various sources and used in the past. Based on this, the financial manager can take corrective action.
- (v) **Acts as a future guide:** Funds Flow Statement acts as a guide for future, to the management. It helps the management to know various problems it is going to face in near future for want of funds.
- (vi) **Appraising the use of working capital:** Funds Flow Statement helps the management in knowing how effectively the working capital put into use.
- (vii) **Reveals financial soundness:** Funds Flow Statement reveals the financial soundness of the business to the creditors, banks, financial institutions.
- (viii) **Changes in working capital:** Funds Flow Statement highlights the changes in working capital. This helps the management in framing its investing policy.
- (ix) **Assessing the degree of risk:** Funds Flow Statement helps the bankers, creditors, financial institutions in assessing the degree of risk involved in granting the credit to the business concern.
- (x) **Net results:** This statement reveals the net results of operations during the year in terms of cash.



### **Limitations of Funds Flow Statement**

The following are the important limitations of Funds Flow Statement

- (i) Funds Flow Statement is not a substitute of Income Statement or a Balance Sheet. It furnished only some additional information as regards changes in Working Capital.
- (ii) This statement lacks originality. It is simply rearrangement of data appearing in account books.
- (iii) It indicates only the past changes. It can not reveal continuous changes.
- (iv) When both the aspects of the transaction are current, they are not considered.
- (v) When both the aspects of the transaction are non-current, even then they are not included in funds flow statement.
- (vi) Some Management Accountants are of the opinion that this statement is not ideal tool for financial analysis.
- (vii) Funds Flow Statement is historic in nature. Hence this projected funds flow statement cannot be prepared with much accuracy.

### **Sources of Funds**

- (i) Issue of share capital.
- (ii) Funds from business operations
- (iii) Issue of debentures of long term loans.
- (iv) Sale of fixed assets or long term investments.
- (v) Non-trading income.
- (vi) Decrease in working capital.
- (vii) Any other increase in liability and decrease in asset.

### **Application of Funds**

- (i) Redemption of preference share capital.
- (ii) Redemption of debentures.
- (iii) Repayment of long-term loans.
- (iv) Purchase of fixed assets or long term investments.
- (v) Payment of dividends and tax.
- (vi) Any other non-trading payment.
- (vii) Funds lost through business operations.
- (viii) Increase in working capital.
- (ix) Any other decrease in liability and increase in asset.



### 7.3 CASH FLOW ANALYSIS

Cash Flow Statement is a statement that explains how cash and cash equivalents held by the business have changed between one balance sheet date and the next one. Cash Flow Statement reveals the causes of changes in cash position of business concern between two dates of Balance Sheets. According to Accounting Standard - 3 (Revised) an enterprise should prepare a Cash Flow Statement and should present it for each period with financial statements prepared. AS-3 (Revised) has also given the meaning of the words cash, cash equivalent and cash flows.

- (i) **Cash:** This includes cash on hand and demand deposits with banks.
- (ii) **Cash equivalents:** Cash Equivalents are short term, highly liquid investments that are readily convertible into cash. This includes purely short term and highly liquid investments which are readily convertible into cash and which are subject to an insignificant risk of changes in value. Therefore an investment normally qualifies as a cash equivalent only when it has a short maturity, of say three months or less.
- (iii) **Cash flows:** This includes inflows and outflows of cash and cash equivalents. If the effect of transaction results in the increase of cash and its equivalents, it is called an inflow (source) and if it results in the decrease of total cash, it is known as outflow (use of cash).

#### Classification of Cash Flows

According to AS-3 (Revised) cash flows are classified into three main categories:

- A. Cash flows from Operating Activities.
- B. Cash flows from Investing Activities.
- C. Cash flows from Financing Activities.

**A. Cash flows from Operating Activities:** Operating activities are the principal revenue-producing activities of the enterprise and other activities that are not investing or financing activities.

The amount of cash flows arising from operating activities is a key indicator of the extent to which the operations of the enterprise have generated sufficient cash flows to maintain the operating capability of the enterprise, pay dividends, repay loans, and make new investments without recourse to external sources of financing.

Cash flows from operating activities are primarily derived from the principal revenue-producing activities of the enterprise. The following are the important operating activities:-

- (i) Cash receipts from the sale of goods and the rendering of services.
- (ii) Cash receipts from royalties, fees, commissions and other revenue.
- (iii) Cash payments to suppliers for goods and services.
- (iv) Cash payments to and on behalf of employees.
- (v) Cash receipts and cash payments of an insurance enterprise for premiums and claims, annuities and other policy benefits,
- (vi) Cash payments or refunds of income taxes unless they can be specifically identified with financing and investing activities,
- (vii) Cash receipts and payments relating in future contracts, forward contracts, option contracts and swap contracts when the contracts are held for dealing or trading purposes.
- (viii) Some transactions such as the sale of an item of plant, may give rise to a gain or loss which is included in the determination of net profit or loss. However, the cash flows relating to such transactions are cash flows from investing activities.



An enterprise may hold securities and loans for dealing or trading purposes, in which case they are similar to inventory acquired specifically for sale. Therefore, cash flows arising from the purchase and sale of dealing or trading activities are classified as operating activities. Similarly cash advances and loans made by financial enterprises are usually classified as operating activities since they relate to the main revenue producing activity of that enterprise.

**B. Cash flows from Investing Activities:** Investing activities are the acquisition and disposal of long-term assets and other investments not included in cash equivalents. The separate disclosure of cash flows arising from investing activities is important because the cash flows represent the extent to which expenditures have been made for resources intended to generate future income and cash flows.

**Examples of cash flows arising from Investing Activities are**

- (i) Cash payments to acquire fixed assets (including intangibles). These payments include those relating to capitalised research & development costs and self constructed fixed assets.
- (ii) Cash receipts from disposal of fixed assets (including intangibles).
- (iii) Cash payments to acquire shares, warrants, or debt instruments of other enterprises and interests in joint ventures.
- (iv) Cash receipts from disposal of shares, warrants, or debt instruments of other enterprises and interests in joint venture.
- (v) Cash advances and loans made to third parties (other than advances and loans made by a financial enterprise).
- (vi) Cash receipts from the repayment of advances and loans made to third parties (other than advances and loans of a financial enterprise).
- (vii) Cash payments for future contracts, forward contracts, option contracts, and swap contracts except when the contracts are held for dealing or trading purposes or the payments are classified as financing activities and
- (viii) Cash receipts from future contracts, forward contracts, option contracts and swap contracts except when the contracts are held for dealing or trading purpose, or the receipts are classified as financing activities.

When a contract is accounted for as a hedge of an identifiable position, the cash flows of the contract are classified in the same manner as the cash flows of the position being hedged.

**C. Cash flows from financing activities:** Financing activities are activities that result in changes in the size and composition of the owners capital (including Preference Share Capital in the case of a company) and borrowing of the enterprise.

The separate disclosure of cash flows arising from financing activities is important because it is useful in predicting claims on future cash flows by providers of funds (both capital and borrowing) to the enterprise.

**Examples of cash flows arising from financing activities are**

- (i) Cash proceeds from issuing shares or other similar instruments.
- (ii) Cash proceeds from issuing debentures loans, notes, bonds and other short-or long-term borrowings and
- (iii) Cash repayments of amounts borrowed such as redemption of debentures, bonds, preference shares.





### Treatment of some typical items

AS - 3 (Revised) has also provided for the treatment of cash flows from some peculiar items as discussed below :

**Extraordinary Items:** The cash flows associated with extraordinary items should be classified as arising from operating, investing or financing activities as appropriate and separately disclosed in the Cash Flows Statement to enable users to understand their nature and effect on the present and future cash flows of the enterprise.

**Interest and Dividends:** Cash flows from interest and dividends received and paid should be disclosed separately. Further, the total amount of interest paid during the period should be disclosed in the Cash Flow Statement whether it has been recognised as an expense in the statement of profit and loss or capitalised. The treatment of interest and dividends received and paid depends upon the nature of the enterprise. For this purpose, the enterprises are classified as (i) Financial enterprises, and (ii) Other enterprises.

- (i) **Financial enterprises:** In the case of financial enterprises, cash flows arising from interest paid and interest and dividend received should be classified as cash flows arising from operating activities.
- (ii) **Other enterprises:** In the case of other enterprises, cash flows arising from interest paid should be classified as cash flows from **financing activities** while interest and dividends received should be classified as cash flows from **investing activities**. Dividends paid should be classified as cash flows from financing activities.

**(c) Taxes on income:** Cash flows arising from taxes on income should be separately disclosed and should be classified as cash flows from operating activities unless they can be specifically identified with financing and investing activities.

**(d) Acquisitions and disposals of subsidiaries and other business units :** The aggregate cash flows arising from acquisitions and from disposals of subsidiaries or other business units should be presented separately and classified as investing activities. An enterprise should disclose, in aggregate in respect of both acquisition and disposal of subsidiaries or other business units during the period each of the following:

- (i) The total purchase or disposal consideration and
- (ii) The portion of the purchase or disposal consideration discharged by means of cash and cash equivalents.

The separate presentation of the cash flow effects of acquisitions and disposals of subsidiaries and other business units as single line items helps to distinguish those cash flows from other cash flows. The cash flow effects of disposals are not deducted from those of acquisitions.

**(e) Foreign currency cash flows:** Cash flows arising from transactions in a foreign currency should be recorded in an enterprise's reporting currency by applying to the foreign currency amount the exchange rate between the reporting currency and the foreign currency at the date of the cash flow. The effect of changes in exchange rates on cash and cash equivalents held in a foreign currency should be reported as a separate part of the reconciliation of the changes in cash and cash equivalents during the period.

Unrealised gains and losses arising from changes in foreign exchange rates are not cash flows. However, the effect of exchange rate changes on cash and cash equivalents held or due in a foreign currency is reported in the Cash Flow Statement in order to reconcile cash and cash equivalents at the beginning and at the end of the period. This amount is presented separately from cash flows from operating investing and financing activities and includes the difference, if any had those cash flows been reported at the end of period exchange rates.

**(f) Non-cash transactions:** Many investing and financing activities do not have a direct impact on current cash flows although they do affect the capital and asset structure of an enterprise.



Examples of non-cash transactions are:

- (i) The acquisition of assets by assuming directly related activities.
- (ii) The acquisition of an enterprise by means of issue of shares; and
- (iii) The conversion of debt to equity.

Investing and financing transactions that do not require the use of cash or cash equivalents should be excluded from a Cash Flow Statement. Such transactions should be disclosed elsewhere in the financial statements in a way that provides all the relevant information about these investing and financing activities.

### **Methods of Calculating Cashflows (Used in) Operating Activities**

There are two methods of reporting cash flows from operating activities namely (1) Direct Method and (2) Indirect Method.

**A. The Direct Method:** Under the direct method, cash receipts (inflows) from operating revenues and cash payments (outflows) for operating expenses are calculated to arrive at cash flows from operating activities. The difference between the cash receipts and cash payments is the net cash flow provided by (or used in) operating activities. The following are the examples of cash receipts and cash payments (called cash flows) resulting from operating activities:

- (a) Cash receipts from the sale of goods and the rendering of services.
- (b) Cash receipts from royalties, fees commissions and other revenues
- (c) Cash payment to suppliers for goods and services
- (d) Cash payment to and on behalf of employees.
- (e) Cash receipts and cash payment of an insurance enterprise for premiums and claims annuities and other policy benefits.
- (f) Cash payments or refund of income taxes unless they can be specifically indentified with financing and investing activities. and
- (g) Cash receipts and payments relating to future contracts, forward contracts, option contracts and swap contracts when the contracts are held for dealing or trading purposes. The formation about major classes of gross cash receipts and gross cash payments may be obtained either:
  - (a) From accounting records of the enterprise; or
  - (b) By adjusting sales, cost of sales (interest and similar income and interest expense and similar charges for a financial enterprise) and other items in the statement of profit and loss for;
    - (i) Changes during the period in inventories and operating receivables and payables,
    - (ii) Other non-cash items, and
    - (iii) Other items for which the cash effects are investing or financing cash flows.

**Format of Cash Flow Statement:** AS-3 (Revised) has not provided any specific format for preparing a Cash Flows Statement. The Cash Flow Statement should report cash flows during the period classified by operating, investing and financing activities; a widely used format of Cash Flow Statement is given below:

**Cash Flow Statement (for the year ended.....)**

Particulars	(₹)	(₹)
<b>Cash Flows from Operating activities</b>		
Cash receipts from customers	xxx	
Cash paid to suppliers and employees	(xxx)	
Cash generated from operations	xxx	
Income tax paid	(xx)	
Cash flow before extraordinary items	xxx	
Extraordinary items	xxx	
Net cash from (used in) Operating activities		xxx
(Or)		
Net profit before tax and extraordinary items	xxx	
Adjustments for non-cash and non-operating items		
(List of individual items such as depreciation, foreign exchange loss, loss on sale of fixed assets, interest income, dividend income, interest expense etc.)	xxx	
Operating profit before working capital changes	xxx	
Adjustments for changes in current assets and current liabilities		
(List of individual items)	xxx	
Cash generated from (used in) operations before tax	xxx	
Income tax paid	xxx	
Cash flow before extraordinary items	xxx	
Extraordinary items (such as refund of tax)	xxx	
Net Cash from (used in) Operating activities		xxx

Particulars	(₹)	(₹)
<b>Cash Flows from investing activities</b>		
Individual items of cash inflows and outflows from financing activities	xxx	
(such as purchase/sale of fixed assets, purchase or sale of investments, interest received, dividend received etc.)	xxx	
Net cash from (used in) investing activities		xxx
<b>Cash Flows from Financing Activities</b>		
Individual items of cash inflows and outflows from financing activities	xxx	
(such as) proceeds from issue of shares, long-term borrowings, repayments of long-term borrowings, interest paid, dividend paid etc.)	xxx	xxx
Net increase (decrease) in cash and cash equivalents		xxx
Cash and cash equivalents at the beginning of the period		xxx
Cash and cash equivalents at the end of the period		xxx



**B. The Indirect Method:** Under the indirect method, the net cash flow from operating activities is determined by adjusting net profit or loss for the effect of:

- Non-cash items such as depreciation, provisions, deferred taxes, and unrealised foreign exchange gains and losses;
- Changes during the period in inventories and operating receivables and payables.
- All other items for which the cash effects are investing or financing cash flows.

The indirect method is also called reconciliation method as it involves reconciliation of net profit or loss as given in the Profit and Loss Account and the net cash flow from operating activities as shown in the Cash Flow Statement. In other words, net profit or losses adjusted for non-cash and non-operating items which may have been debited or credited to Profit and Loss Account as follows.

#### Calculation of Cash Flow from Operating Activities

Particulars	(₹)	(₹)
Net profit before tax and extraordinary items		xxx
Add : Non-cash and non-operating items which have already been debited to P.L. Account		
(a) Depreciation	xxx	
(b) Transfer to reserves and provisions	xxx	
(c) Good will written off	xxx	
(d) Preliminary expenses written off	xxx	
(e) Other intangible assets written off such as discount or loss on issue of shares / debentures, underwriting commission etc.	xxx	
(f) Loss on sale or disposal of fixed assets	xxx	
(g) Loss on sale of investments	xxx	
(h) Foreign exchange loss	xxx	xxx
Less : Non-cash and non-operating items which have already been credited to P.L. Account		xxx
(a) Gain on sale of fixed assets	xxx	
(b) Profit on sale of investments	xxx	
(c) Income from interest or dividends on investments	xxx	
(d) Appreciation	xxx	
(e) Reserves written back	xxx	
(f) Foreign exchange gain	xxx	xxx

Particulars	(₹)	(₹)
		xxx
Operating Profit Before Working Capital Changes		
Adjustments for changes in current operating assets and liabilities:		
Add : Decrease in Accounts of Current Operating Assets (except cash and cash equivalents) such as :		
Decrease in trade debts	xxx	
Decrease in bills receivables	xxx	



Decrease in inventories / stock-in-trade	xxx	
Decrease in prepaid expenses etc.	xxx	
Add : Increase in accounts of current operating liabilities (except Bank overdraft) such as :		
Increase in creditors	xxx	
Increase in bills payable	xxx	
Increase in outstanding expenses	xxx	xxx
		xxxx
Less : Increase in accounts of current operating assets (as stated above)		xxx
		xxx
Less : Decrease in accounts of current operating liabilities (as stated above)		xxx
Cash generated from (used in) operations before tax		xxx
Less : Income tax paid		xxx
Cash flows before extraordinary items		xxx
Add / Less : Extraordinary items if any		xxx
Net cash flow from (used in) operating activities		xxx

### Need of Preparing Cash Flow Statement

Cash Flow Statement shows the changes in cash position between two Balance Sheet dates. It provides the details in respect of cash generated through operating, investing and financial activities and utilised for operating, investing and financial activities. The transactions which increase the cash position of the business are known as Inflows of cash (ex: Sale of current and fixed assets, Issue of shares and debentures etc.) The transactions which decrease the cash position are known as outflows (ex: Purchase of Current and Fixed Assets, redemption of Debentures, and Preference Shares and other long term debts). Cash Flow Statement concentrates on transactions that have a direct impact on cash. This statement depicts factors responsible for such inflow and outflow of cash.

- (i) Cash Flow Statement reveals the causes of changes in cash balances between two Balance Sheet dates.
- (ii) This statement helps the management to evaluate its ability to meet its obligations i.e., payment to creditors, the payment of bank loan, payment of interest, taxes, dividend etc.
- (iii) It throws light on causes for poor liquidity in spite of good profits and excessive liquidity in spite of heavy losses.
- (iv) It helps the management in understanding the past behaviour of cash cycle and in controlling the use of cash in future.
- (v) Cash Flow Statements helps the management in planning repayment of loans, replacement of assets etc.
- (vi) This statement is helpful in short-term financial decisions relating to liquidity.
- (vii) This statement helps the management in preparing the cash budgets properly.
- (viii) This statement helps the financial institution who lends advances to business concerns in estimating their repaying capacities.
- (ix) Since a Cash Flow Statement is based on the cash basis of accounting it is very useful in evaluation of cash position of a firm.



- (x) Cash Flow Statement discloses the complete story of cash movement. The increase in, or decrease of cash and the reason therefore can be known.
- (xi) Cash Flow Statement provides information of all activities such as operating, investing, and financing activities separately.
- (xii) Since Cash Flow Statement provides information regarding the sources and utilisation of cash during a particular period, it is easy for the management to plan carefully for the cash requirements in the future, for the purpose of redeeming long-term liabilities or and replacing some fixed assets.
- (xiii) A projected Cash Flow Statement reveals the future cash position of a concern. Through this Cash Flow Statement the firm can know how much cash it can generate and how much cash will be needed to make various payments.
- (xiv) Cash Flow Statement prepared according the AS-3 (Revised) is more suitable for making comparison than the funds flow statements as there is no standard formats used for the same.

### Limitations of Cash Flow Statement

Cash Flow Statement suffers from the following limitations.

- (i) A Cash Flow Statement only reveals the inflow and outflow of cash. The cash balance disclosed by the Cash Flow Statement may not represent the real liquid position of the concern.
- (ii) Cash Flow Statement is not suitable for judging the profitability of a firm as non-cash changes are ignored while calculating cash flows from operating activities.
- (iii) Cash Flow Statement is not a substitute for Income Statement or Funds Flow Statement. Each of them has a separate function to perform. Net Cash Flow disclosed by Cash Flow Statement does not necessarily be the net income of the business, because net income is determined by taking into account both cash and non-cash items.
- (iv) Cash Flow Statement is based on cash accounting. It ignores the basic accounting concept of a accrual basis.
- (v) Cash Flow Statement reveals the movement of cash only. In preparation it ignores most liquid current assets (ex: Sundry debtors, Bills Receivable etc.)
- (vi) It is difficult to precisely define the term cash. There are controversies among accountants over a number of near cash items like cheques, stamps, postal orders etc., to be included in cash.
- (vii) Cash Flow Statement does not give a complete picture of financial position of the concern.

### Differences between Funds Flow Statement and Cash Flow Statement

The following are the main differences between a Funds Flow Statement and a Cash Flow Statement:-

<b>Funds Flow Statement</b>	<b>Cash Flow Statement</b>
1. Funds Flow Statement reveals the change in working capital between two Balance Sheet dates	Cash Flow Statement reveals the changes in cash position between two balance sheet dates.
2. Funds Flow Statement is based on accounting	Cash Flow Statement is based on cash basis of accounting
3. In the case of Funds Flow Statement a schedule of changes in working capital is prepared.	No such schedule of changes in working capital is prepared for a Cash Flow Statement.



4. Funds Flow Statement is useful in planning, Intermediate and long term financing.	Cash Flow Statement as a tool of financial analysis is more useful for short-term analysis and cash planning.
5. Funds Flow Statement deals with all components of working capital.	Cash Flow Statement deals only with cash and cash equivalents.
6. Funds Flow Statement reveals the sources and application of funds. The difference represents net increase or decrease in working capital.	Cash Flow Statement is prepared by taking into consideration the inflows and outflows in terms of operating, investing and financing activities. The net difference represents the net increase or decrease in cash and cash equivalents.

## ILLUSTRATIONS – FUND FLOW STATEMENT

### Illustration 11

From the following Balance Sheet of PKJ Ltd., Prepare Funds Flow Statement for 2016.

₹ '000

Liabilities	31-3-15	31-3-16	Assets	31-3-15	31-3-16
Equity Share Capital	150	200	Goodwill	50	40
9% Redeemable Preference Share capital	75	50	Land & Buildings	100	85
Capital Reserve	—	10	Plant & Machinery	40	100
General Reserve	20	25	Investments	10	15
Profit & Loss Account	15	24	Sundry Debtors	70	85
Proposed Dividend	21	25	Stock	39	55
Sundry Creditors	13	24	Bills Receivable	10	15
Bills Payable	10	8	Cash in hand	7	5
Liability for Expenses	15	18	Cash at bank	5	4
Provision for tax	20	25	Preliminary Exp.	8	5
	<b>339</b>	<b>409</b>		<b>339</b>	<b>409</b>

Additional information:

1. A part of land was sold out in 2016, and the profit was credited to Capital Reserve.
2. A machine has been sold for ₹5,000 (written down value of the machinery was ₹6,000). Depreciation of ₹5,000 was charged on plant in 2016.
3. An interim dividend of ₹10,000 has been paid in 2016.
4. An Amount of ₹1,000 has been received as dividend on investment in 2016.

**Solution:****Funds flow Statement**

Sources	(₹ '000)	Application	(₹ '000)
Funds from Operation	67	Investment Purchased	5
Sale proceed of Plant	5	Increase in Working Capital	16
Sale proceed of Land	25	Purchase of Plant & Machinery	71
Issue of Equity Share Capital	50	Redemption of Preference Share Capital	25
Dividend on Investments received	1	Proposed Dividend for last year	21
		Interim dividend paid	10
	<b>148</b>		<b>148</b>

**Working Note 1:****1. Calculation of changes in Working Capital:**

	Amount (₹) in '000	
	31-3-15	31-3-16
Current Asset		
Debtors	70	85
Stock	39	55
B/R	10	15
Cash in hand	7	5
Cash at bank	5	4
<b>A: Total Current Assets</b>	<b>131</b>	<b>164</b>

	Amount (₹) in '000	
	31-3-15	31-3-16
Current Liabilities		
Creditors	13	24
B/P	10	8
Liabilities for exp.	15	18
Provision for Tax	20	25
<b>B: Total Current Liabilities</b>	<b>58</b>	<b>75</b>
<b>Working capital (A-B)</b>	<b>73</b>	<b>89</b>

Increase in working capital  $89 - 73 = 16$ **2. Calculation of Fixed assets purchase during the year****Dr.****Plant and Machinery A/c****Cr.**

Particulars	(₹ '000)	Particulars	(₹ '000)
To Balance b/d	40	By Bank – sale proceeds	5
To Bank – Purchases (Bal. fig.)	71	By P & L-Loss	1
		By Depreciation	5
		By Balance C/f	100
	111		111



Dr.		Land and Building A/c		Cr.	
Particulars	(₹ '000)	Particulars	(₹ '000)		
To Balance b/d	100	By Bank (Bal. fig.)	25		
To Profit-Transfer to C/R	10	By balance c/f	85		
	110		110		

### 3. Calculation of Funds from Operation

Dr.		P& L Adjustment A/c		Cr.	
Particulars	(₹ '000)	Particulars	(₹ '000)		
To Depreciation	5	By balance b/d	15		
To Loss on sale of machinery	1	By Dividend Received	1		
To Interim Dividend	10				
To Transfer to G/R	5				
To Proposed Dividend	25				
To Goodwill written off	10				
To Preliminary exp. written off	3				
To Closing balance	24	Funds from Operation (Bal. fig.)	67		
	83		83		

### Illustration 12

The Balance Sheets of A, B, & C Co. Ltd. as at the end of 2015 and 2016 are given below:

LIABILITIES	2015 (₹)	2016 (₹)	ASSETS	2015 (₹)	2016 (₹)
Share Capital	1,00,000	1,50,000	Freehold land	1,00,000	1,00,000
Share premium	---	5,000	Plant at cost	1,04,000	1,00,000
General Reserve	50,000	60,000	Furniture at cost	7,000	9,000
Profit & Loss Account	10,000	17,000	Investments	60,000	80,000
6% Debentures	70,000	50,000	Debtors	30,000	70,000
Provision for Depreciation on Plant	50,000	56,000	Stock	60,000	65,000
Provision for Dep. on Furniture	5,000	6,000	Cash	30,000	45,000
Provision for taxation	20,000	30,000			
Sundry Creditors	86,000	95,000			
	3,91,000	4,69,000		3,91,000	4,69,000

A plant purchased for ₹ 4,000 (Depreciation ₹ 2,000) was sold for Cash for ₹ 800 on September 30, 2015. On June 30, 2015 an item of furniture was purchased for ₹ 2,000. These were the only transactions concerning fixed assets during 2015. A dividend of 22½ % on original shares was paid. You are required to prepare funds Flow Statement and verify the results by preparing a schedule of changes in Working Capital.

**Solution:****Calculation of changes in Working Capital**

Current Asset	2015	2016	Current Liabilities	2015	2016
Debtors	30,000	70,000	Creditors	86,000	95,000
Stock	60,000	65,000	Provision for Tax	20,000	30,000
Cash	30,000	45,000	<b>B: Total Current Liabilities</b>	<b>1,06,000</b>	<b>1,25,000</b>
<b>A: Total Current Assets</b>	<b>1,20,000</b>	<b>1,80,000</b>	<b>Working capital (A-B)</b>	<b>14,000</b>	<b>55,000</b>

Increase in working capital ₹ 55,000 – ₹ 14,000 = ₹ 41,000

**Funds flow Statement**

Sources	Amount (₹)	Application	Amount (₹)
Funds from Operation	49,700	Investment Purchased	20,000
Sale proceed of plant	800	Increase in Working Capital	41,000
Issue of Equity Share Capital with premium	55,000	Dividend paid	22,500
		Purchase of furniture	2,000
		Redemption of Debentures	20,000
	1,05,500		1,05,500

**Working Note:****1. Calculation of Depreciation provide during the year****Provision for depreciation on plant**

Opening Balance	50,000
Less: Depreciation on plant sold	2,000
	48,000
Depreciation provided during the year (b/f)	8,000
Depreciation at the end	56,000

**Total Depreciation provided during the year**

On Plant (as above)	8,000
On Furniture (6,000-5,000)	1,000
Total depreciation provided during the year	9,000

**Dr.****Investment A/c****Cr.**

Particulars	Amount (₹)	Particulars	Amount (₹)
To Balance b/d	60,000		
To Bank – purchases (Bal. Fig)	20,000	By Balance c/f	80,000
	80,000		80,000



Dr.		P & L Adjustment A/c		Cr.	
Particulars	Amount (₹)	Particulars	Amount (₹)		
To Depreciation	9,000	By Balance b/d	10,000		
To Transfer to G/R	10,000				
To Loss on Sale of Plant	1,200				
To Dividend (1,00,000 × 22.5%)	22,500				
To Balance c/f	17,000	By Funds from Operation (Bal Fig)	49,700		
	59,700		59,700		

**Illustration 13**

From the Balance Sheet of A Ltd., Please prepare:

- A. A Statement of changes in the Working Capital.
- B. Funds Flow Statement.

**BALANCE SHEET**

	31st March			31st March	
	2015 (₹)	2016 (₹)		2015 (₹)	2016 (₹)
<b>LIABILITIES</b>			<b>ASSETS</b>		
Equity Share Capital:	3,00,000	4,00,000	Goodwill	1,15,000	90,000
8% Preference share capital	1,50,000	1,00,000	Land & Buildings	2,00,000	1,70,000
P & L A/c	30,000	48,000	Plant	80,000	2,00,000
General Reserve	40,000	70,000	Debtors	1,60,000	2,00,000
Proposed Dividend	42,000	50,000	Stock	77,000	1,09,000
Creditors	55,000	83,000	Bills Receivable	20,000	30,000
Bills Payable	20,000	16,000	Cash in hand	15,000	10,000
Provision for Taxation	40,000	50,000	Cash at Bank	10,000	8,000
	6,77,000	8,17,000		6,77,000	8,17,000

Following is the additional information available:

- (i) Depreciation of ₹ 10,000 and ₹ 20,000 have been charged on Plant and Land and Buildings respectively in 2016.
- (ii) Interim dividend of ₹ 20,000 has been paid in 2016.
- (iii) Income tax of ₹ 35,000 has been paid in 2016.

**Solution:****A. Calculation of changes in Working Capital**

Current Asset	2015	2016
Debtors	1,60,000	2,00,000
Stock	77,000	1,09,000
B/R	20,000	30,000
Cash in hand	15,000	10,000
Cash at Bank	10,000	8,000
<b>A: Total Current Assets</b>	<b>2,82,000</b>	<b>3,57,000</b>



Current Liabilities	2015	2016
Creditors	55,000	83,000
B/P	20,000	16,000
B: Total Current Liabilities	75,000	99,000
Working capital (A-B)	2,07,000	2,58,000

Increase in working capital ₹ 2,58,000 – ₹ 2,07,000 = ₹ 51,000

### B. Funds flow Statement

Sources of fund		Application of fund	
Funds from Operation	2,30,000	Purchases of Plant	1,30,000
Sale proceed of Land & Building	10,000	Increase in Working Capital	51,000
Issue of Equity Share Capital	1,00,000	Tax Paid	35,000
		Redemption of Preference Share Capital	50,000
		Proposed Dividend	42,000
		Interim Dividend paid	20,000
		Preference Dividend paid	12,000
			3,40,000

#### Working Note:

#### 1. Land & Buildings A/c

Dr.		Cr.	
Particulars	Amount (₹)	Particulars	Amount (₹)
To Balance b/d	2,00,000	By Depreciation provided	20,000
		By Bank – sale proceeds (b/f)	10,000
		By Balance c/f	1,70,000
	2,00,000		2,00,000

#### 2. Plant A/c

Dr.		Cr.	
Particulars	Amount (₹)	Particulars	Amount (₹)
To Balance b/d	80,000	By Depreciation provided	10,000
To Bank (b/f)	1,30,000	By Balance c/f	2,00,000
	2,10,000		2,10,000

#### 3. Provision for Tax A/c

Dr.		Cr.	
Particulars	Amount (₹)	Particulars	Amount (₹)
To Bank – paid	35,000	By Balance b/d	40,000
To balance c/f	50,000	By P & L A/c – provided	45,000
	85,000		85,000



## 4. P &amp; L Adjustment A/c

Dr.

Cr.

Particulars	Amount (₹)	Particulars	Amount (₹)
To Depreciation	30,000	By Balance b/d	30,000
To Preference Dividend (1,50,000 x 8%)	12,000		
To Transfer to G/R	30,000		
To Provision for Tax	45,000		
To Proposed Dividend	50,000		
To Goodwill written off	25,000		
To Interim Dividend	20,000		
To Balance C/f	48,000	By Funds from Operation (b/f)	2,30,000
	2,60,000		2,60,000

## Illustration 14

From the following figures, prepare a statement showing the changes in the Working Capital and Funds Flow Statement during the year 2015.

ASSETS:	Dec.31, 2014	Dec.31, 2015
Fixed Assets (net) ₹	5,10,000	6,20,000
Investments	30,000	80,000
Current Assets	2,40,000	3,75,000
Discount on debentures	10,000	5,000
	7,90,000	10,80,000
<b>Liabilities:</b>		
Equity share capital	3,00,000	3,50,000
Preference share capital	2,00,000	1,00,000
Debentures	1,00,000	2,00,000
Reserves	1,10,000	2,70,000
Provision for doubtful debts	10,000	15,000
Current Liabilities	70,000	1,45,000
	7,90,000	10,80,000

You are informed that during the year:

- A machine costing ₹ 70,000 book value ₹ 40,000 was disposed of for ₹ 25,000.
- Preference share redemption was carried out at a premium of 5% and
- Dividend at 15% was paid on equity shares for the year 2014.

## Further:

- The provision for depreciation stood at ₹ 1,50,000 on 31.12.14 and at ₹ 1,90,000 on 31.12.15; and
- Stock which was valued at ₹90,000 as on 31.12.14; was written up to its cost, ₹ 1,00,000 for preparing Profit and Loss account for the year 2015.

**Solution:****Funds Flow Statement**

Sources of fund	Amount (₹)	Applications of fund	Amount (₹)
Sale of Fixed Assets	25,000	Increase in Working Capital	50,000
Funds from Operation	2,95,000	Purchase of Fixed Assets	2,20,000
Issue of shares	50,000	Purchase of Investments	50,000
Debentures	1,00,000	Redemption of Preference Shares	1,05,000
		Dividend paid	45,000
	4,70,000		4,70,000

**Working note:****1. Changes in Working Capital**

	2014	2015
Current Assets	2,40,000	3,75,000
(+) Stock under valued	10,000	
	2,50,000	3,75,000
Current Liabilities	70,000	1,45,000
Net Working Capital	1,80,000	2,30,000
Increase in Working Capital	50,000	

**2. Depreciation**

	(₹)
Opening Provision	1,50,000
(-) Provided on sale of asset	30,000
	1,20,000
(+) Provided during the year (b/f)	70,000
Closing provision	1,90,000

**3. Purchase & sale of Fixed Assets**

	(₹)
Opening (2016)	5,10,000
(-) Provided on sale of asset	40,000
(-) Sold	4,70,000
(-) Depreciation provided	70,000
	4,00,000
(+) Purchases (b/f)	2,20,000
Closing (2016)	6,20,000



### P&L Adjustment A/c

Particulars	Amount (₹)	Particulars	Amount (₹)
To Depreciation	70,000	By Balance b/d (110000+10000)	1,20,000
To Loss on Sale of Fixed Assets	15,000	By Funds from Operations	2,95,000
To Loss on Redemption of Shares	5,000	By Funds from Operations (Bal. figure)	
To Discount written off	5,000		
To Provision for Doubtful debt	5,000		
To Dividend	45,000		
To Balance c/d	2,70,000		
	<b>4,15,000</b>		<b>4,15,000</b>

### Illustration 15

The directors of Chintamani Ltd. present you with the Balance Sheets as on 30th June, 2015 and 2016 and ask you to prepare statements which will show them what has happened to the money which came into the business during the year 2016.

	(₹)	(₹)
<b>Liabilities:</b>	<b>30.6.15</b>	<b>30.6.16</b>
Authorised Capital 15,000 shares of ₹ 100 each	15,00,000	15,00,000
Paid up capital	10,00,000	14,00,000
Debentures (2016)	4,00,000	---
General Reserve	60,000	40,000
P & L Appropriation A/c	36,000	38,000
Provision for the purpose of final dividends	78,000	72,000
Sundry Trade Creditors	76,000	1,12,000
Bank Overdraft	69,260	1,29,780
Bills Payable	40,000	38,000
Loans on Mortgage	-	5,60,000
	<b>17,59,260</b>	<b>23,89,780</b>
<b>Assets</b>		
Land & Freehold Buildings	9,00,000	9,76,000
Machinery and Plant	1,44,000	5,94,000
Fixtures and Fittings	6,000	5,500
Cash in hand	1,560	1,280
Sundry Debtors	1,25,600	1,04,400
Bills Receivable	7,600	6,400
Stock	2,44,000	2,38,000
Prepayments	4,500	6,200
Share in other companies	80,000	2,34,000
Goodwill	2,40,000	2,20,000
Preliminary expenses	6,000	4,000
	<b>17,59,260</b>	<b>23,89,780</b>



You are given the following additional information:

- (a) Depreciation has been charged (i) on Freehold Buildings @ 2½% p.a. on cost ₹10,00,000. (ii) on Machinery and Plant ₹32,000 (iii) on Fixtures and Fittings @5% on cost, ₹10,000. No depreciation has been written off on newly acquired Building and Plant and Machinery.
- (b) A piece of land costing ₹1,00,000 was sold in 2016 for ₹2,50,000. The sale proceeds was credited to Land and Buildings.
- (c) Shares in other companies were purchased and dividends amounting to ₹6,000 declared out of profits made prior to purchase has received and used to write down the investment (shares).
- (d) Goodwill has been written down against General Reserve.
- (e) The proposed dividend for the year ended 30th June 2015 was paid and, in additions, an interim dividend, ₹52,000 was paid.

**Solution:**

#### Funds Flow Statement

Sources of fund	Amount (₹)	Applications of fund	Amount (₹)
Decrease in Working capital	1,21,500	Purchase of land and building	2,01,000
Sale proceed of land	2,50,000	Purchase of plant and machinery	4,82,000
Dividend received	6,000	Purchase of shares	1,60,000
Issue of shares	4,00,000	Redemption of debentures	4,00,000
Loan	5,60,000	Dividends for 2011 paid	78,000
Funds from operations	35,500	Interim dividend paid	52,000
	13,73,000		13,73,000

#### Working Note

##### 1. Changes in working capital

	2015	2016
<b>Current Assets</b>		
Cash	1,560	1,280
Debtors	1,25,600	1,04,400
Bills Receivable	7,600	6,400
Prepaid	4,500	6,200
Stock	2,44,000	2,38,000
	3,83,260	3,56,280
<b>Current liabilities</b>		
Creditors	76,000	1,12,000
Overdraft	69,260	1,29,780
Bills Payable	40,000	38,000
	1,85,260	2,79,780
Working Capital	1,98,000	76,500
Decrease in working capital		1,21,500



**Working note No. 2: Depreciation**

On Buildings	25,000
On Plant & Machinery	32,000
On Furniture & Fittings	500
	57,500

**3. Purchase or sale of Fixed Assets / Investments:****Land and buildings:**

	(₹)
WDV (2015)	9,00,000
(-) Depreciation	25,000
	8,75,000
(-) Land sold	2,50,000
	6,25,000
(+) Purchases (b/f)	2,01,000
(+) Profit on sale	8,26,000
WDV (2016)	1,50,000

**Plant & machinery:**

	(₹)
WDV (2015)	9,76,000
(-) Depreciation	1,44,000
	32,000
(+) Purchase (b/f)	1,12,000
WDV (2016)	4,82,000
	5,94,000

**Investments:**

	(₹)
WDV (2015)	80,000
(-) Dividend in capital nature	6,000
	74,000
(+) Purchases (b/f)	1,60,000
WDV (2016)	2,34,000

**4. P & L Adjustment A/c**

Particulars	Amount (₹)	Particulars	Amount (₹)
To depreciation	57,500	By Balance b/d	36,000
To dividend proposed	72,000	By Profit on sale of Land	1,50,000
To preliminary expenses written off	2,000	By funds from operation (bal figure)	35,500
To interim dividend	52,000		
To balance c/d	38,000		
	2,21,500		2,21,500

**Illustration 16**

The following is the Balance Sheets of the Andhra Industrial Corporation Ltd. as on 31st December 2015 and 2016.

**BALANCE SHEET**

<b>Assets:</b>	<b>2015</b>	<b>2016</b>
<b>Fixed Assets:</b> Property	1,48,500	1,44,250
Machinery	1,12,950	1,26,200
Goodwill	----	10,000
<b>Current Assets:</b> Stock	1,10,000	92,000
Trade Debtors	86,160	69,430
Cash at Bank	1,500	11,000
Pre-payments	3,370	1,000
	<b>4,62,480</b>	<b>4,53,880</b>
<b>Liabilities:</b>		
Shareholders funds: Paid up Capital	2,20,000	2,70,000
Reserves	30,000	40,000
Profit and Loss Account	39,690	41,220
<b>Current Liabilities:</b> Creditors	39,000	41,660
Bills Payable	33,790	11,000
Bank Overdraft	60,000	–
Provision for taxation	40,000	50,000
	<b>4,62,480</b>	<b>4,53,880</b>

During the year ended 31st December, 2016, a dividend of ₹ 26,000 was paid and assets of another company were purchased for ₹ 50,000 payable in fully paid-up shares. Such assets purchased were:

Stock ₹ 21,640; Machinery ₹ 18,360; and Goodwill ₹ 10,000. In addition Plant at a cost of ₹ 5,650 was purchased during the year; depreciation on Property ₹ 4,250; on Machinery ₹ 10,760. Income tax during the year amounting to ₹ 28,770 was charged to provision for taxation. Net profit for the year before tax was ₹ 76,300.

Prepare Funds Flow Statement for the year 2016.

**Solution:****Funds Flow Statement**

<b>Sources</b>	<b>Amount (₹)</b>	<b>Applications</b>	<b>Amount (₹)</b>
Issue of shares for stock	21,640	Increase in working capital	52,530
Funds from operation	91,310	Purchase of machinery	5,650
		Tax paid	28,770
		Dividend paid	26,000
	<b>1,12,950</b>		<b>1,12,950</b>

**Working Note:****Provision for Tax A/c**

Particulars	Amount (₹)	Particulars	Amount (₹)
To Cash paid	28,770	By balance b/d	40,000
To Balance c/d	50,000	By P&L A/c (b/f)	38,770
	78,770		78,770

**Verification of P & L A/c Balance**

	(₹)	(₹)
Opening P & L a/c		39,690
(+) net profit as per P & L A/c	76,300	
(-) provision for tax	38,770	
	37,530	
(-) dividend	26,000	
(-) transfer to reserve	10,000	
Retained		1,530
Profit at the end of the year		41,220

**Changes in Working Capital**

	(₹)	(₹)
	Opening	Closing
<b>Current assets :</b>		
Stock	1,10,000	92,000
Debtors	86,160	69,430
Cash	1,500	11,000
Pre-Payment	3,370	1,000
	2,01,030	1,73,430
<b>Current liabilities</b>		
Creditors	39,000	41,660
Bills payable	33,790	11,000
Overdraft	60,000	52,660
	1,32,790	
Net Working Capital	68,240	1,20,770
Increase in Working Capital	52,530	

**4. Depreciation provided during the year**

On Property	4,250
On machinery	10,760
	15,010

**5. Purchase/sale of Fixed Assets**

	Property	Machinery
WDV opening	1,48,500	1,12,950
(-) Depreciation	4,250	10,760
	1,44,250	1,02,190
(+) Purchases	Ni	18,360 (by issue of shares)
WDV at the end		5,650 (by cash)
	1,44,250	1,26,200

Dr.		P & L Adjustment A/c		Cr.	
Particulars	Amount (₹)	Particulars	Amount (₹)		
To Depreciation	15,010	By Balance b/d	39,690		
To Dividend	26,000	By Funds from Operations(b/f)	91,310		
To Transfer to reserve	10,000				
To Provision for tax	38,770				
To Balance c/d	41,220				
	1,31,000				1,31,000

**Illustration 17**

The following is the Balance Sheet of Gama Limited for the year ending March 31, 2015 and March 31, 2016;

Particulars	2015 (₹)	2016 (₹)
<b>Capital and Liabilities</b>		
Share Capital	6,75,000	7,87,500
General Reserves	2,25,000	2,81,250
Capital Reserve (Profit on Sale of Investment)	--	11,250
Profit & Loss Account	1,12,500	2,25,000
15% Debentures	3,37,500	2,25,000
Accrued Expenses	11,250	13,500
Creditors	1,80,000	2,81,250
Provision for Dividends	33,750	38,250
Provision for Taxation	78,750	85,500
<b>Total</b>	<b>16,53,750</b>	<b>19,48,500</b>
<b>Assets</b>		
Fixed Assets	11,25,000	13,50,000
Less: Accumulated depreciation	2,25,000	2,81,250
Net Fixed Assets	9,00,000	10,68,750
Long – Term Investments (at cost)	2,02,500	2,02,500



Stock (at cost)	2,25,000	3,03,750
Debtors (net of provision for doubtful debts of ₹ 45,000 and ₹ 56,250 respectively for 2015 and 2016 respectively)	2,53,125	2,75,625
Bills receivables	45,000	73,125
Prepaid Expenses	11,250	13,500
Miscellaneous Expenditure	16,875	11,250
<b>Total</b>	<b>16,53,750</b>	<b>19,48,500</b>

**Additional Information:**

1. During the year 2015-16, fixed assets with a net book value of ₹11,250 (accumulated depreciation, ₹ 33,750) was sold for ₹ 9,000.
2. During the year 2015-16, Investments costing ₹90,000 were sold, and also Investments costing ₹90,000 were purchased.
3. Debentures were retired at a Premium of 10%.
4. Tax of ₹61,875 was paid for 2015-16.
5. During the year 2015-16, bad debts of ₹ 15,750 were written off against the provision for Doubtful Debt account.
6. The proposed dividend for 2007-2008 was paid in 2015-16.

**Required:**

Prepare a Fund Flow Statement (Statement of changes in Financial Position on working capital basis) for the year ended March 31, 2016.

**Solution:**

**In the books of Gama Ltd.**  
**Fund Flow Statement**  
**For the year ended March 31, 2016**

Sources of Fund	Amount (₹)	Application of Funds	Amount (₹)
Increase in Share Capital	1,12,500	Debenture Redemption	1,12,500
Sale of Assets	9,000	Redemption Premium	11,250
Fund from operation	3,84,750	Tax paid	61,875
Sale of Investment	1,01,250	Dividend paid	33,750
		Increase in WC	28,125
		Purchase of fixed assets	2,70,000
		Purchase of investment	90,000
	<b>6,07,500</b>		<b>6,07,500</b>

**Working Notes:****Statement showing funds from Operations**

Particulars	Amount (₹)	Amount (₹)
Net Profit [2,25,000 – 1,12,500]		1,12,500
Add: Transfer to General Reserve (2,81,250 – 2,25,000)	56,250	
Loss on sale of fixed assets (11,250 – 9,000)	2,250	
Premium on Redemption of Debentures (1,12,500 × 10%)	11,250	
Provision for Tax	68,625	
Provision for Dividend	38,250	
Depreciation	90,000	
Misc. exp. w/off	5,625	2,72,250
Funds from Operation (16,875 – 11,250)		3,84,750

**Statement showing changes in Working Capital**

Particulars	Amount (₹)	Amount (₹)
	2015	2016
<b>Current Assets</b>		
Stock	2,25,000	3,03,750
Debtors	2,53,125	2,75,625
Bills Receivables	45,000	73,125
Prepaid Expenses	11,250	13,500
<b>Total Current Assets (A)</b>	<b>5,34,375</b>	<b>6,66,000</b>
<b>Current Liabilities</b>		
Accrued Expenses	11,250	13,500
Creditors	1,80,000	2,81,250
Total Current Liabilities	1,91,250	2,94,750
Working Capital (A) – (B)	3,43,125	3,43,125
<b>Increase in Working Capital</b>		<b>28,125</b>

**Provision for Doubtful Debt A/c**

Dr.

Cr.

Particulars	Amount (₹)	Particulars	Amount (₹)
To Bad Debts	15,750	By Balance b/d	45,000
To Balance c/d	56,250	By P & L A/c	27,000
	<b>72,000</b>		<b>72,000</b>

**Provision for Dividends**

Dr.

Cr.

Particulars	Amount (₹)	Particulars	Amount (₹)
To Div. paid	33,750	By Balance b/d	33,750
To Balance c/d	38,250	By P & L A/c	38,250
	<b>72,000</b>		<b>72,000</b>

**Provision for Tax**

Dr.		Cr.	
Particulars	Amount (₹)	Particulars	Amount (₹)
To Tax paid	61,875	By Balance b/d	78,750
To Balance c/d	85,500	By P & L A/c	68,625
	<b>1,47,375</b>		<b>1,47,375</b>

**Accumulated Depreciation A/c**

Dr.		Cr.	
Particulars	Amount (₹)	Particulars	Amount (₹)
To Asset sold	33,750	By Balance b/d	2,25,000
To Balance c/d	2,81,250	By P & L A/c	90,000
	<b>3,15,000</b>		<b>3,15,000</b>

**Fixed Assets A/c**

Dr.		Cr.	
Particulars	Amount (₹)	Particulars	Amount (₹)
To Balance b/d	11,25,000	By Account Depreciation	33,750
To Bank	2,70,000	By Bank	9,000
		By P & L A/c	2,250
		By Balance c/d	13,50,000
	<b>13,95,000</b>		<b>13,95,000</b>

**ILLUSTRATIONS – CASH FLOW STATEMENT****Illustration 18**

From the information contained in Income Statement and Balance Sheet of 'A' Ltd, prepare Cash Flow Statement.

**Income Statement for the year ended March 31, 2016**

	(₹)
Net Sales	(A) 2,52,00,000
Less:	
Cash cost of sales	1,98,00,000
Depreciation	6,00,000
Salaries and Wages	24,00,000
Operating Expenses	8,00,000
Provision for Taxation	8,80,000
	(B) 2,44,80,000
Net Operating Profit (A – B)	7,20,000
Non-recurring Income – Profits on sale of equipment	1,20,000
	8,40,000



Retained earnings and Profits brought forward	15,18,000
	23,58,000
Dividends declared and paid during the year	7,20,000
Profit and Loss A/c balance as on March 31, 2016	16,38,000

**Balance Sheet as on**

	(₹)	(₹)
<b>Assets</b>	<b>March 31, 2015</b>	<b>March 31, 2016</b>
<b>Fixed Assets:</b>		
Land	4,80,000	9,60,000
Buildings and Equipment	36,00,000	57,60,000
<b>Current Assets:</b>		
Cash	6,00,000	7,20,000
Debtors	16,80,000	18,60,000
Stock	26,40,000	9,60,000
Advances	78,000	90,000
	<b>90,78,000</b>	<b>1,03,50,000</b>

**Balance Sheet as on**

	(₹)	(₹)
<b>Liabilities and Equity</b>	<b>March 31, 2015</b>	<b>March 31, 2016</b>
Share Capital	36,00,000	44,40,000
Surplus in Profit and Loss A/c	15,18,000	16,38,000
Sundry Creditors	24,00,000	23,40,000
Outstanding Expenses	2,40,000	4,80,000
Income – Tax payable	1,20,000	1,32,000
Accumulated Depreciation on Buildings and Equipment	12,00,000	13,20,000
	<b>90,78,000</b>	<b>1,03,50,000</b>

The original cost of equipment sold during the year 2015-16 was ₹ 7,20,000.

**Solution:****Working Notes:****1. Cash receipt from customers**

	(₹)
Sales revenue	2,52,00,000
Add: Debtor at beginning	16,80,000
	2,68,80,000
Less: Debtor at the end	18,60,000
Total cash receipt from customer	2,50,20,000





## 2. Income tax paid

	(₹)
Tax payable at beginning	1,20,000
Add: Provision for taxation	8,80,000
	10,00,000
Less: Tax payable at the end	1,32,000
Tax paid during the year	8,68,000

## 3. Cash paid to supplier & employee

	(₹)	(₹)
Cost of goods sold		1,98,00,000
Add: Operating expenses		8,00,000
Salary and wages		24,00,000
		<b>2,30,00,000</b>
Add: Creditor at the beginning	24,00,000	
Stock at the end	9,60,000	
Advance at the end	90,000	
Outstanding exp. at the beginning	2,40,000	36,90,000
		<b>2,66,90,000</b>
Less: Creditors at the end	23,40,000	
Stock at the beginning	26,40,000	
Advance at the beginning	78,000	
Outstanding expenses at the end	4,80,000	55,38,000
Total Cash Paid		<b>2,11,52,000</b>

## 4. Accumulated depreciation on equipment sold

	(₹)
Accumulated depreciation at beginning	12,00,000
Add: Depreciation for the year	6,00,000
	<b>18,00,000</b>
Less: Accumulated depreciation at the end	13,20,000
Accumulated depreciation on equipment sold	<b>4,80,000</b>

## 5. Sale price of equipment

	(₹)
Cost Price	7,20,000
Less: Accumulated depreciation	4,80,000
	<b>2,40,000</b>
Add: Profit on sale	1,20,000
Sale price	<b>3,60,000</b>



## 6. Purchase of building and equipments

	(₹)
Opening balance	36,00,000
Less: Cost of equipment sold	7,20,000
	<b>28,80,000</b>
Balance at end	57,60,000
Purchase during the year	<b>28,80,000</b>

### Cash Flow Statement of A Ltd. for the year ended 31st March 2016

	(₹)	(₹)
<b>(A) Cash flow from Operating Activity:</b>		
Cash receipt from customers	2,50,20,000	
Less: Cash paid to supplier & employees	2,11,52,000	
Cash generated from operation	38,68,000	
Less: Income tax paid	(8,68,000)	
Net cash from operating activity		30,00,000
<b>(B) Cash flow from Investing Activity:</b>		
Purchase of land	(4,80,000)	
Purchase of building & equipment	(28,80,000)	
Sale of equipment	3,60,000	
Net cash used in financing activity		(30,00,000)
<b>(C) Cash flow from Financing Activity:</b>		
Issue of share capital	8,40,000	
Dividends paid	(7,20,000)	
Net cash from financing activity		1,20,000
Net increase in cash & cash equivalent		1,20,000
Cash & Cash equivalent at beginning		6,00,000
Cash & Cash equivalent at the end		7,20,000

### Illustration 19

The Balance Sheet of JK Limited as on 31st March, 2015 and 31st March, 2016 are given below:

#### Balance Sheet as on

(₹ '000')

Liabilities	31.03.15	31.03.16	Assets	31.03.15	31.03.16
Share Capital	1,440	1,920	Fixed Assets	3,840	4,560
Capital Reserve	--	48	Less: Depreciation	1,104	1,392
General Reserve	816	960	Net Fixed Asset	2,736	3,168
Profit and Loss A/c	288	360	Investment	480	384
9% Debenture	960	672	Cash	210	312
Current Liabilities	576	624	Other Current Assets		
Proposed Dividend	144	174	(including Stock)	1,134	1,272
Provision for Tax	432	408	Preliminary Expenses	96	48
Unpaid Dividend	--	18			
	<b>4,656</b>	<b>5,184</b>		<b>4,656</b>	<b>5,184</b>

**Additional Information:**

1. During the year 2015-2016, Fixed Assets with a book value of ₹2,40,000 (accumulated depreciation ₹ 84,000) was sold for ₹ 1,20,000.
2. Provided ₹ 4,20,000 as depreciation.
3. Some investments are sold at a profit of ₹48,000 and profit was credited to Capital Reserve.
4. It decided that stocks be valued at cost, whereas previously the practice was to value stock at cost less 10 per cent. The stock was ₹ 2,59,200 as on 31.03.15. The stock as on 31.03.16 was correctly valued at ₹ 3,60,000.
5. It decided to write off Fixed Assets costing ₹60,000 on which depreciation amounting to ₹ 48,000 has been provided.
6. Debentures are redeemed at ₹ 105.

**Required:**

Prepare a Cash Flow Statement.

**Solution:****Cash Flow Statement (as on 31st March, 2016)**

	(₹)	(₹)	(₹)
<b>1. Cash flows from Operating Activities</b>			
Profit and Loss A/c [3,60,000 -(2,88,000 + 28,800)]			43,200
Adjustments:			
Increase in General Reserve	1,44,000		
Depreciation	4,20,000		
Provision for Tax	4,08,000		
Loss on Sale of Machine	36,000		
Premium on Redemption of debenture	14,400		
Proposed Dividend	1,74,000		
Preliminary Exp written off	48,000		
Fixed Assets written off	12,000		12,56,400
Funds from operation			12,99,600
Increase in Sundry Creditors			48,000
Increase in Current Assets [12,72,000 -(11,34,000 + 28,800)]			(1,09,200)
Cash before Tax			12,38,400
Tax paid			4,32,000
Net Cash from operating activities			8,06,400
<b>2. Cash from Investing Activities</b>			
Purchase of fixed assets		(10,20,000)	
Sale of Investment		1,44,000	
Sale of Fixed Assets		1,20,000	(7,56,000)



<b>3. Cash from Financing Activities</b>			
Issue of Share Capital		4,80,000	
Redemption of Debenture		(3,02,400)	
Dividend paid		(1,26,000)	51,600
Net increase in Cash and Cash equivalents			1,02,000
Opening Cash and Cash equivalents			2,10,000
Closing Cash			3,12,000

**Working Notes:**

**Fixed Assets Account**

Dr.		Cr.	
Particulars	Amount (₹)	Particulars	Amount (₹)
To Balance b/d	27,36,000	By Cash	1,20,000
To Purchases (balancing figure)	10,20,000	By Loss on sales	36,000
		By Depreciation	4,20,000
		By Assets written off	12,000
		By Balance c/d	31,68,000
	37,56,000		37,56,000

**Depreciation Account**

Dr.		Cr.	
Particulars	Amount (₹)	Particulars	Amount (₹)
To Fixed Assets (on sales)	84,000	By Balance b/d	11,04,000
To Fixed Assets w/o	48,000	By Profit and Loss A/c	4,20,000
To Balance c/d	13,92,000		
	15,24,000		15,24,000

**Illustration 20**

Balance Sheets of a company as on 31<sup>st</sup> March, 2015 and 2016 were as follows:

(₹'000')

Liabilities	31.03.15	31.03.16	Assets	31.03.15	31.03.16
Equity share capital	10,00,000	10,00,000	Goodwill	1,00,000	80,000
8% Pref. Share capital	2,00,000	3,00,000	Land and Building	7,00,000	6,50,000
General Reserve	1,20,000	1,45,000	Plant and Machinery	6,00,000	6,60,000
Securities Premium	---	25,000	Investments (non trading)	2,40,000	2,20,000
Profit & Loss A/c.	2,10,000	3,00,000	Stock	4,00,000	3,85,000
11% Debentures	5,00,000	3,00,000	Debtors	2,88,000	4,15,000
Creditors	1,85,000	2,15,000	Cash and Bank	88,000	93,000
Provision for tax	80,000	1,05,000	Prepaid Expenses	15,000	11,000
Proposed Dividend	1,36,000	1,44,000	Premium on Redemption of debenture	---	20,000
	<b>24,31,000</b>	<b>25,34,000</b>		<b>24,31,000</b>	<b>25,34,000</b>

**Additional Information:**

1. Investments were sold during the year at a profit of ₹ 15,000.
2. During the year an old machine costing ₹ 80,000 was sold for ₹ 36,000. Its written down value was ₹ 45,000.
3. Depreciation charged on Plant and Machinery @ 20% on the opening balance.
4. There was no purchase or sale of Land and Building.
5. Provision for tax made during the year was ₹ 96,000.
6. Preference shares were issued for consideration of cash during the year.

**You are required to prepare:**

- a. Cash Flow Statement as per AS-3.
- b. Schedule of changes in Working Capital.

**Solution:****a. Cash Flow Statement as per AS-3.****Cash Flow Statement for the year ending 31st March, 2016**

	Particulars	Amount (₹)	Amount (₹)
A	<b>Cash flow from Operating Activities</b>		
	Profit and Loss A/c as on 31.3.2016		3,00,000
	Less: Profit and Loss A/c as on 31.3.2015		2,10,000
			90,000
	Add: Transfer to General Reserve	25,000	
	Provision for Tax	96,000	
	Proposed Dividend	1,44,000	2,65,000
	Profit before Tax		3,55,000
	Adjustment for Depreciation		
	Land and Building	50,000	
	Plant and Machinery	1,20,000	1,70,000
	Profit on Sale of Investments		(15,000)
	Loss on Sale of Plant and Machinery		9,000
	Goodwill written off		20,000
	Interest on Debenture		33,000
	Operating Profit before Working Capital changes		5,72,000
	Adjustment for Working Capital changes:		
	Decrease in Prepaid Expenses		4,000
	Decrease in Stock		15,000
	Increase in Debtors		(1,27,000)
	Increase in Creditors		30,000
	Cash generated from Operations		4,94,000
	Income tax paid		(71,000)
	<b>Net Cash Inflow from Operating Activities (a)</b>		<b>4,23,000</b>



<b>B</b>	<b>Cash flow from Investing Activities</b>		
	Sale of Investment		35,000
	Sale of Plant and Machinery		36,000
	Purchase of Plant and Machinery		(2,25,000)
	<b>Net Cash Outflow from Investing Activities (b)</b>		<b>(1,54,000)</b>
<b>C</b>	<b>Cash flow from Financing Activities</b>		
	Issue of Preference Shares		1,00,000
	Premium received on issue of securities		25,000
	Redemption of Debentures at a premium		(2,20,000)
	Dividend paid		(1,36,000)
	Interest paid to Debenture holders		(33,000)
	<b>Net Cash outflow from Financing Activities (c)</b>		<b>(2,64,000)</b>
	Net increase in Cash and Cash Equivalents during the year (a+b+c)		5,000
	Cash and Cash Equivalents at the beginning of the year		88,000
	Cash and Cash Equivalents at the end of the year.		93,000

**Working Notes:****Provision for the Tax Account**

Dr.		Cr.	
Particulars	Amount (₹)	Particulars	Amount (₹)
To Bank (paid)	71,000	By Balance b/d	80,000
To Balance c/d	1,05,000	By Profit and Loss A/c	96,000
	<b>1,76,000</b>		<b>1,76,000</b>

**Investment Account**

Dr.		Cr.	
Particulars	Amount (₹)	Particulars	Amount (₹)
To Balance b/d	2,40,000	By balance (bal fig)	35,000
To profit and loss (profit on sale)	15,000	By balance c/d	2,20,000
	<b>2,55,000</b>		<b>2,55,000</b>

**Plant & Machinery Account**

Dr.		Cr.	
Particulars	Amount (₹)	Particulars	Amount (₹)
To Balance b/d	6,00,000	By Bank (sale)	36,000
To Bank A/c (Purchase)	2,25,000	By Profit and Loss A/c (loss on sale)	9,000
		By Depreciation	1,20,000
		By Balance c/d	6,60,000
	<b>8,25,000</b>		<b>8,25,000</b>

**Note:**

In this question, the date of redemption of debentures is not mentioned. So, it is assumed that the debentures are redeemed at the beginning of the year.

**b. Schedule of change in Working Capital**

Particulars	31 March 2015 (₹)	31 March 2016 (₹)	Changes in Working Capital	
			Increase (₹)	Decrease (₹)
<b>Current Assets</b>				
Stock	4,00,000	3,85,000	--	15,000
Debtors	2,88,000	4,15,000	1,27,000	--
Prepaid Expenses	15,000	11,000	--	4,000
Cash and Bank	88,000	93,000	5,000	--
<b>Total (A)</b>	<b>7,91,000</b>	<b>9,04,000</b>		
<b>Current Liabilities</b>				
Creditors	1,85,000	2,15,000	--	30,000
<b>Total (B)</b>	<b>1,85,000</b>	<b>2,15,000</b>		
Working Capital (A-B)	6,06,000	6,89,000		83,000
Increase in Working Capital	83,000	--	--	
	<b>6,89,000</b>	<b>6,89,000</b>	<b>1,32,000</b>	<b>1,32,000</b>

**Illustration 21**

The Balance Sheets of a company as on 31st March, 2015 and 2016 are given below:

(₹)

Liabilities	31.03.15	31.03.16	Assets	31.03.15	31.03.16
Equity Share Capital	14,40,000	19,20,000	Fixed Assets	38,40,000	45,60,000
Capital Reserve	--	48,000	Less: Depreciation	(11,04,000)	(13,92,000)
General Reserve	8,16,000	9,60,000		27,36,000	31,68,000
Profit & Loss A/c	2,88,000	3,60,000	Investment	4,80,000	3,84,000
9% Debentures	9,60,000	6,72,000	Sundry Debtors	12,00,000	14,00,000
Sundry Creditors	5,50,000	5,90,000	Stock	1,40,000	1,84,000
Bills Payable	26,000	34,000	Cash in hand	4,000	--
Proposed Dividend	1,44,000	1,72,800	Preliminary Expenses	96,000	48,000
Provision for tax	4,32,000	4,08,000			
Unpaid dividend	--	19,200			
	46,56,000	51,84,000		46,56,000	51,84,000

**Additional Information:**

During the year ended 31st March, 2016 the company:

- Sold a machine for ₹ 1,20,000; the cost of machine was ₹ 2,40,000 and depreciation provided on it was ₹ 84,000.
- Provided ₹ 4,20,000 as depreciation on fixed assets.
- Sold some investment and profit credited to capital reserve.
- Redeemed 30% of the debenture @ 105.
- Decided to write off fixed assets costing ₹ 60,000 on which depreciation amounting to ₹ 48,000 has been provided.



You are required to prepare Cash Flow Statement as per AS-3.

**Solution:**

**Cash Flow Statement for the year ending 31st March, 2016**

	Particulars	Amount (₹)	Amount (₹)
<b>A</b>	<b>Cash flow from Operating Activities</b>		
	Profit and Loss A/c (3,60,000 – 2,88,000)		72,000
	Adjustments:		
	Increase in General Reserve	1,44,000	
	Depreciation	4,20,000	
	Provision for Tax	4,08,000	
	Loss on Sale of Machine	36,000	
	Premium on Redemption of Debentures	14,400	
	Proposed Dividend	1,72,800	
	Preliminary Expenses written off	48,000	
	Fixed Assets written of	12,000	
	Interest on Debentures	60,480	13,15,680
	Funds from Operations		13,87,680
	Increase in Sundry Creditors	40,000	
	Increase in Bills Payable	8,000	
		48,000	
	Increase in Sundry Debtors	(2,00,000)	
	Increase in Stock	(44,000)	(1,96,000)
	Cash before tax		11,91,680
	Less: Tax paid		4,32,000
	<b>Cash in flows from Operating Activities</b>		<b>7,59,680</b>
<b>B</b>	<b>Cash in flows from Investing Activities</b>		
	Purchase of Fixed Assets	(10,20,000)	
	Sale of Investment	1,44,000	
	Sale of Fixed Assets	1,20,000	
	<b>Cash out flows from Investing Activities</b>		<b>(7,56,000)</b>
<b>C</b>	<b>Cash Flows from Financing Activities</b>		
	Issue of share capital	4,80,000	
	Redemption of Debentures	(3,02,400)	
	Dividend Paid (1,44,000 – 19,200)	(1,24,800)	
	Interest on Debentures	(60,480)	
	Cash outflow from Financing Activities		(7,680)
	Net Increase in Cash and Cash Equivalentts		(4,000)
	Cash and Cash Equivalentts at the beginning of the year		4,000
	Cash and Cash Equivalentts at the end of the year		Nil



**Working Note:**

- (1) It is presumed that the 30 percent debentures have been redeemed at the beginning of the year.  
 (2)

<b>Dr.</b>		<b>Fixed Assets Account</b>		<b>Cr.</b>	
Particulars	Amount (₹)	Particulars	Amount (₹)		
To Balance b/d	27,36,000	By Cash	1,20,000		
To Purchases (balance figure)	10,20,000	By Loss on sales	36,000		
		By Depreciation	4,20,000		
		By Assets written off	12,000		
		By Balance c/d	31,68,000		
	<b>37,56,000</b>			<b>37,56,000</b>	

**Illustration 22**

The summarized Balance Sheet of XYZ Limited as at 31st March, 2015 and 2016 are given below:

Liabilities	2015 (₹)	2016 (₹)	Assets	2015 (₹)	2016 (₹)
Preference share capital	4,00,000	2,00,000	Plant and Machinery	7,00,000	8,20,000
Equity share capital	4,00,000	6,60,000	Long term investment	3,20,000	4,00,000
Share Premium A/c	40,000	30,000	Goodwill	---	30,000
Capital Redemption Reserve	---	1,00,000	Current Assets	9,10,000	11,41,000
General Reserve	2,00,000	1,20,000	Short term investment (less than 2 months)	50,000	84,000
P & L A/c	1,30,000	1,75,000	Cash and Bank	1,00,000	80,000
Current Liabilities	6,40,000	9,00,000	Preliminary Expenses	40,000	20,000
Proposed Dividend	1,60,000	2,10,000			
Provision for tax	1,50,000	1,80,000			
	<b>21,20,000</b>	<b>25,75,000</b>		<b>21,20,000</b>	<b>25,75,000</b>

**Additional Information:**

During the year 2016 the company:

- Preference share capital was redeemed at a premium of 10% partly out of proceeds issue of 10,000 equity shares of ₹10 each issued at 10% premium and partly out of profits otherwise available for dividends.
- The company purchased plant and machinery for ₹95,000. It also acquired another company stock ₹25,000 and plant and machinery ₹1,05,000 and paid ₹1,60,000 in Equity share capital for the acquisition.
- Foreign exchange loss of ₹1,600 represents loss in value of short term investment.
- The company paid tax of ₹1,40,000.

You are required to prepare Cash Flow Statement.



**Solution:**

**Cash Flow Statement as per AS 3 for the year ending 31st March, 2016**

	Particulars	Amount (₹)	Amount (₹)
<b>A</b>	<b>Cash flow from Operating Activities</b>		
	Profit before tax (2,75,000 + 1,70,000)	4,45,000	
	Add: Depreciation on machinery	80,000	
	Foreign exchange loss	1,600	
	Preliminary expenses written off	20,000	
	Cash flow before working capital adjustment	5,46,600	
	Add: Stock acquired from other company	25,000	
	Increase in Current Liabilities	2,60,000	
	Less: Increase in Current Assets	(2,31,000)	
	Cash flow before tax paid	6,00,600	
	Less: Tax paid	(1,40,000)	
	Cash flow from operating activities		4,60,600
<b>B</b>	<b>Cash flow from Investing Activities</b>		
	Purchase of Machinery	(95,000)	
	Purchase of Investment	(80,000)	(1,75,000)
<b>C</b>	<b>Cash flow from Financing Activities</b>		
	Issue of shares at premium	1,10,000	
	Payment of Dividend	(1,60,000)	
	Redemption of preference shares at premium	(2,20,000)	(2,70,000)
	Net increase/decrease in cash and cash equivalent (a+b+c)		15,600
	Cash and cash equivalent at the beginning of the year		1,50,000
	Cash and cash equivalent at the end of the year		1,65,600

**Working Notes:**

<b>Plant and Machinery Account</b>			
Dr.	Particulars	Amount (₹)	Cr.
	To Balance b/d	7,00,000	By Depreciation (balancing figure)
	To Bank A/c	95,000	By Balance c/f
	To acquired from other	1,05,000	
		<b>9,00,000</b>	
			<b>9,00,000</b>

<b>Provision for Tax Account</b>			
Dr.	Particulars	Amount (₹)	Cr.
	To Bank A/c	1,40,000	By Balance b/d
	To Balance c/f	1,80,000	By P & L
		<b>3,20,000</b>	
			<b>3,20,000</b>

<b>Profit for the year 2016</b>		
Dr.	Particulars	Amount (₹)
	P & L Account (1,75,000 – 1,30,000)	45,000
	Transfer to general reserve (1,20,000 + 1,00,000 for Redemption – Opening 2,00,000)	20,000
	Proposed dividend	2,10,000
	<b>Net profit</b>	<b>2,75,000</b>



#### 4. Cash and Cash Equivalent

Opening balance + Short term investment = 1,00,000 + 50,000 = ₹1,50,000.

Closing balance = Closing cash + Short term investment + Foreign exchange loss  
= 80,000 + 84,000 + 1,600 = ₹1,65,600

### GLOSSARY

**Cash Equivalents:** Cash Equivalents are short term, highly liquid investments that are readily convertible into cash.

**Cash Flow Statement:** Cash Flow Statement is a statement that explains how cash and cash equivalents held by the business have changed between one balance sheet date and the next one.

**Fund Flow Statement:** Funds Flow Statement is a widely used tool for analysing the financial performance of a business concern. It gives detailed analysis of changes in distribution of resources between two Balance Sheet dates.

**Funds from Financing:** Funds from Financing is the accounting of funds related to financing of a company. It includes the payment of dividends, the fund flow on issue of shares, the money borrowed, repayment of past loan etc.

**Funds from Investments:** Funds from Investments is the accounting of funds related to investments of a company. It includes the money gained or lost by investing excess cash in different securities, divestment of fixed assets, the money spent on acquiring fixed assets etc.

**Funds from Operations:** The changes in the working capital due to the operations are called funds from operations. It indicates the difference between the inflow of funds on account of revenue and the outflow of funds on account of expenses.

**Ratio:** A Ratio is a statistical yard stick that provides a measure of the relationship between variables or figures. This relationship can be expressed as percent (cost of goods sold as a percent of sales) or as a quotient (current assets as a certain number of times the current liabilities).

**Ratio Analysis:** Ratio analysis is the process of determining and interpreting numerical relationships based on financial statements.

#### Self Learning Questions:

1. Write a short note on Window Dressing.
2. What are the benefits accrue out of Ratio Analysis?
3. State the various standards used for comparison in Ratio Analysis.
4. State the ratios used in the following mentioned industries;
  - a. Hotel Industry
  - b. Banking Industry
  - c. Telecom Industry
  - d. Transport Industry
5. State the significance of Short term solvency Ratio.
6. Discuss any three ratios computed for investment analysis.
7. Discuss the financial ratios for evaluating company performance on operating efficiency and liquidity position aspects.
8. What do you mean by Stock Turnover ratio and Gearing ratio?
9. Explain briefly the limitations of Financial Ratios.
10. List down the significance of Fund Flow Statement.



11. Write a short note on the following
  - a. Fund Flow statement
  - b. Cash Flow Statement
12. Distinguish between Cash Flow Statement and Fund Flow Statement.
13. State the need to prepare Cash Flow Statement.
14. What are the ingredient of Cash and Cash equivalents used while preparation of Cash Flow Statement.
15. What are the commonly employed measures of Financial Performance?
16. Write a short note on Debt Service Ratio (DSCR).
17. Based on the following, what will be the amount of Inventory?  
Current Ratio = 2.6:1      Liquid ratio = 1.5:1      Current Liabilities = 40,000.
18. Pankaj Farm Supplies has an 8 % return on total assets of ₹3,00,000 and a net profit margin of 5%. Calculate Sales.
19. The earning power of Pankaj Ltd is 30. If the average of total assets and interest expenses are ₹2,00,000 and ₹ 15,000 respectively. What will be the interest coverage ratio?
20. A company has a profit margin @ 25% and assets turnover of 3 times. What is the company's return of Investment?

[Ans: (17) ₹64,000; (18) ₹48,00,000]

**Multiple Choice Questions:**

1. Ratio of Net sales to Net working capital is a:
  - (a) Profitability ratio
  - (b) Current ratio
  - (c) Liquidity ratio
  - (d) Working capital turnover ratio
2. Long-term solvency is indicated by:
  - (a) Current ratio
  - (b) Debt/equity ratio
  - (c) Operating ratio
  - (d) Net profit ratio
3. Ratio of net profit before interest and tax to sales is:
  - (a) Gross profit ratio
  - (b) Operating profit ratio
  - (c) Net profit ratio
  - (d) Interest coverage ratio
4. The Receivable-Turnover ratio helps management to:
  - (a) Managing inventory
  - (b) Managing resources
  - (c) Managing working capital
  - (d) Managing customer relationship

[Ans. d, b, b, c]



# Study Note - 8

## WORKING CAPITAL MANAGEMENT



This Study Note includes:

- 8.1 Working Capital Management – Financing of Working Capital
- 8.2 Inventory Management
- 8.3 Management of Receivables
- 8.4 Determinant of Credit Policy
- 8.5 Evaluation of Credit Policy
- 8.6 Cash Management

### 8.1 WORKING CAPITAL MANAGEMENT - FINANCING OF WORKING CAPITAL

#### WORKING CAPITAL - MEANING & DEFINITION

The term Working Capital also called gross working capital refers to the firm's aggregate of Current Assets and current assets are these assets which can be convertible into cash within an accounting period, generally a year. Therefore, they are Cash or mere cash resources of a business concern. However, we can understand the meaning of Working Capital from the following:

- (a) "Working capital means the funds available for day-to-day operations of an enterprise. It also represents the excess of current assets over current liabilities including short-term loans". — Accounting Standards Board, The Institute of Chartered Accountants of India.
- (b) "Working capital is that portion of a firm's current assets which is financed by short term funds."— Gitman, L.J. From the above definitions, we can say that the working capital is the firm's current assets or the excess of current assets over current liabilities. However, the later meaning will be more useful in most of the times as in all cases we may not find excess of current assets over current liabilities.

#### Concepts of Working Capital

Working capital has two concepts:

- (i) Gross working capital and
- (ii) Net working capital.

Gross Working capital refers to the total of the current assets and net working capital refers to the excess of the current assets over current liabilities. Though both concepts are important for managing it, gross working capital is more helpful to the management in managing each individual current assets for day-to-day operations. But, in the long run, it is the net working capital that is useful for the purpose.

When we want to know the sources from which funds are obtained, it is not working capital that is more important and should be given greater emphasis. The definition given by the Accountants, U.S.A., will give clear view of working capital which is given below:



Working capital sometimes called net working capital, is represented by excess of current assets over current liabilities and identifies the relatively liquid portion of total enterprise capital which constitutes a margin of better for maturing obligations within the ordinary operation cycle of the business."

Each concern has its own limitations and constraints within which it has to decide whether it should give importance to gross or net working capital.

As discussed above, the term Working Capital is the difference between the current assets and current liabilities.

**Current Assets:** An asset is classified as current asset when:

- (a) it is expected to be realised or intends to be sold or consumed in normal operating cycle of the organisation;
- (b) the asset is held primarily for the purpose of trading;
- (c) it is expected to be realised within twelve months after the reporting period;
- (d) it is non-restricted cash or cash equivalent.

Generally current assets of an organisation, for the purpose of working capital management can be classified into the following main heads:

- (i) Inventory (raw material, work in process and finished goods)
- (ii) Receivables (trade receivables and bills receivables)
- (iii) Cash or cash equivalents (short-term marketable securities)
- (iv) Prepaid expenses

**Current Liabilities:** A liability is classified as current liability when:

- (a) it is expected to be settled in normal operating cycle of the organisation;
- (b) the liability is held primarily for the purpose of trading;
- (c) it is expected to be settled within twelve months after the reporting period.

Generally current liabilities of an organisation, for the purpose of working capital management can be classified into the following main heads:

- (i) Payable (trade payables and bills receivables)
- (ii) Outstanding payments (wages & salary etc.)

Working capital management is essentially the management of Current Assets and current liabilities in an organisation.

### **KINDS OF WORKING CAPITAL**

There are two kinds of working capital, the distinction of which made keeping in view the nature of such funds in a business concern, which are as follows:

- (a) Rigid, fixed, regular or permanent working capital; and
- (b) Variable, seasonal, temporary or flexible working capital.

Every business concern has to maintain certain minimum amount of current assets at all times to carry on its activities efficiently and effectively. It is indispensable for any business concern to keep some material as stocks, some in the shape of work-in-progress and some in the form of finished goods.

Similarly, it has to maintain certain amount of cash to meet its day-to-day requirements. Without such minimum amounts, it cannot sustain and carry on its activities. Therefore, some amount of working capital i.e., current assets is permanent in the business without any fluctuations like fixed assets and such amount is called Working Capital. To say precisely, Permanent Working Capital is the irreducible minimum amount of working capital necessary to carry on its activities without any interruptions. It is that minimum amount necessary to outlays its fixed assets effectively.

On the other hand, temporary working capital is that amount of current assets which is not permanent and fluctuating from time to time depending upon the company's requirements and it is generally financed out of short term funds, It may also high due to seasonal character of the industry as such it is also called seasonal working capital.

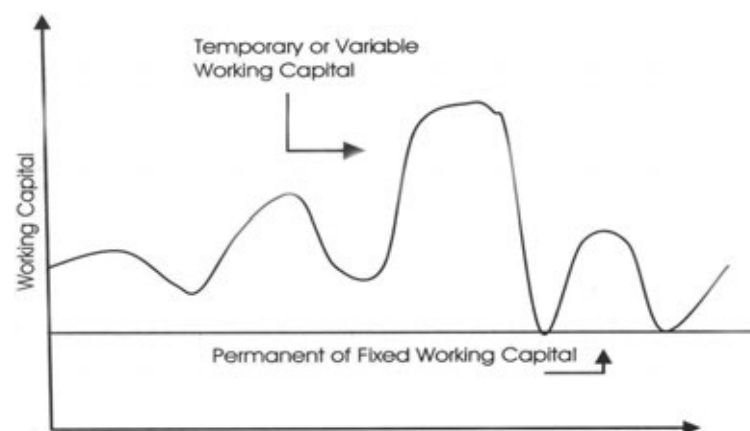

### ADEQUACIES AND INADEQUACIES OF WORKING CAPITAL

Working Capital of a business should be commensurate with its needs. Too high or too low working capital of a business or two extremes of working capital are equally dangerous to the existence of the business enterprise itself.

High amount of working capital, though increases its liquidity position but reduces its profitability and on the other hand too low working capital though increases its profitability reduces its liquidity. Both such extreme situations may cause business concerns to shut down.

#### DANGER OF TOO HIGH AMOUNT OF WORKING CAPITAL

- It results in unnecessary accumulation of inventories and gives chance to inventory mishandling, wastage, pilferage, theft, etc., and losses increase.
- Excess working capital means idle funds which earns no profits for the business.
- It shows a defective credit policy of the company resulting in higher incidence of bad debts and adversely affects Profitability.
- It results in overall inefficiency.

#### DANGER OF INADEQUATE OR LOW AMOUNT OF WORKING CAPITAL

- It becomes difficult to implement operating plans and achieve the firm's profit target.
- It stagnates growth and it will become difficult to the firm to undertake profitable ventures for non availability of working capital funds.



- (c) It may not be in a position to meet its day-to-day current obligations and results in operational inefficiencies.
- (d) The Return on Investment falls due to under utilisation of fixed assets and other capacities of the business concern.
- (e) Credit facilities in the market will be lost due to faulty working capital.
- (f) The reputation and goodwill of the firm will also be impaired considerably.

**WORKING CAPITAL CYCLE**

Working Capital Cycle or Operating Cycle are synonymous terms in the context of management of working capital. Any business concern, whether it is of financial nature, trade organisation or a manufacturing organisation needs certain time to net fruits of the efforts. That is, by investment of cash, producing or doing something for some time will fetch profit. But soon after the investment of cash, it cannot get that profit by way of cash again immediately. It takes time to do so. The time required to take from investment of cash in some assets and conversion of it again into cash termed as operating or working capital cycle. Here the cycle refers to the time period.

Chart for Operating Cycle or Working Capital Cycle.

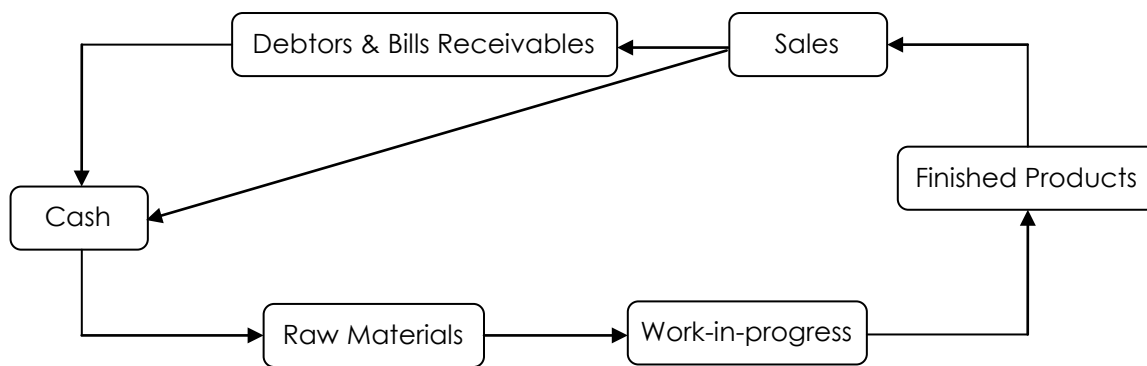

In case of trading concerns, the operating cycle will be: Cash → Stock → Debtors → Cash.

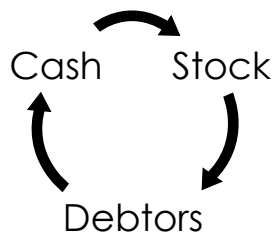

In case of financial concerns, the operating cycle will be: Cash → Debtors → Cash only.

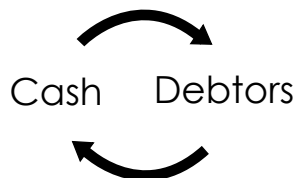

It is obvious from the above that the time gap between the sales and their actual realisation of cash is technically termed as Operating Cycle or Working Capital Cycle.





The period of working capital cycle may differ from one business enterprise to the other depending upon the nature of the enterprise and its activities. It means the pattern of working capital cycle do change according to its activities.

### **Determinants of Working Capital**

The size or magnitude and amount of working capital will not be uniform for all organisations. It differs from one type of organisation to the other type of organisation. Depending upon various conditions and environmental factors of each and every organisation. There are many factors that determine the size of working capital. However, there are some factors, which are common to the most of the business concerns. Such factors are enumerated below:

- 1. Nature and size of the Business:** A company's working capital requirements depends on the activities it carried on and its size too. For instance, public utility organisation or service organisation where its activities are of mere service nature, does not require high amount of working capital, as it has no need of maintaining any stocks of inventories. In case of trading organisation the magnitude of working capital is high as it requires to maintain certain stocks of goods as also some credit to debtors. Further, if we go to manufacturing organisation the cycle period of working capital is high because the funds are to be invested in each and every type of inventory forms of raw-material, work-in-progress, finished goods as also debtors. Industrial units too require a large amount of working capital.
- 2. Production Policies:** These policies will have a great significance in determining the size of the working capital. Where production policies are designed in such a way that uniform production is carried on throughout the accounting period, such concern requires a uniform and lesser amount of working capital. On the other hand, the concerns with production policies according to the needs of the customers will be peak at sometimes and require high amount of working capital. In seasonal industries too, where production policies are laid down tightly in the business season requires a high amount of working capital.
- 3. Process of Manufacture:** If the manufacturing process of a particular industry is longer due to its complex nature, more working capital is required to finance that process, because, longer the period of manufacture, the larger the inventory tied up in the process and naturally requires a high amount of working capital.
- 4. Growth and Expansion of Business:** A business concern at status requires a uniform amount of working capital as against the concerns which are growing and expanding. It is the tendency of any business organisation to grow further and further till its saturation point, if any. Such growth may be within the existing units by increased activities. Similarly, business concerns will expand their organisation by establishing new units. In both the cases, the need for working capital requirement increases as the organisation increases.
- 5. Fluctuations in the Trade Cycle:** Business activities vary according to the general fluctuations in the world. There are four stages in a trade cycle which affects the activities of any business concern. Accordingly, the requirements of working capital are bound to change. When conditions of boom prevail, it is the policy of any prudent management to build or pile up large stock of inventories of various forms to take the advantage of the lower prices. Such fluctuations causes a business concern to demand for more amount of working capital. The other phase of trade cycle i.e., depression i.e., low or absence of business activities cause business concerns to demand for more working capital. In condition of depression, the products produced are not sold due to fall in demand, lack of purchasing power of the people. As a result of which entire production obtained was not sold in the market and high inventories are piled up. Therefore, there arises the need for heavy amount of working capital.

Thus, the two extreme stages of trade cycles make the business concerns to demand for more working capital. In the former case due to acts and policies of management and in the later case due to natural phenomena of trade cycle.



6. **Terms and conditions of Purchases and Sales:** A business concern which allows more credit to its customers and buys its supplies for cash requires more amount of working capital. On the other hand, business concerns which do not allow more credit period to its customers and seek better credit facilities for their supplies naturally require lesser amount of working capital.
7. **Dividend Policy:** A consistent dividend policy may affect the size of working capital. When some amount of working capital is financed out of the internal generation of funds such affect will be there. The relationship between dividend policy and working, capital is well established and very few companies declare dividend without giving due consideration to its effects on cash and their needs for cash.

If the dividend is to be declared in cash, such outflow reduces working capital and therefore, most of the business concerns declare dividend now-a-days in the form of bonus shares as such retain their cash. A shortage of working capital acts as powerful reason for reducing or skipping cash dividend.

8. **Price Level Changes:** The changes in prices make the functions of a finance manager difficult. The anticipations of future price level changes are necessary to avoid their affects on working capital of the firm. Generally, rising price level will require a company to demand for more amount of working capital, because the same level of current assets requires higher amount of working capital due to increased prices.
9. **Operating Efficiency:** The Operating efficiency of a firm relates to its optimum utilisation of resources available whether in any form of factor of production, say, capital, labour, material, machines etc; If a company is able to effectively operate its costs, its operating cycle is accelerated and requires relatively lessor amount of working capital. On the other hand, if a firm is not able to utilise its resources properly will have slow operating cycle and naturally requires higher amount of working capital.
10. **Percentage of Profits and Appropriation out of Profits:** The capacity of all the firms will not be same in generating their profits. It is natural that some firms enjoy a dominant and monopoly positions due to the quality of its products, reputations, goodwill etc. (for example Colgate Tooth Paste, Bata Chapels etc.), and some companies will not have such position due to poor quality and other inherent hazards.

The company policy of retaining or distribution of profits will also affect the working capital. More appropriation out of profits than distribution of profit necessarily reduces the requirements of working capital.

11. **Other Factors:** Apart from the above general considerations, there may be some factors responsible for determination of working capital which are inherent to the type of business. Some of such factors may be as follows:
  - (a) General co-ordination and control of the activities in the organisation.
  - (b) Absence of specialisation of products and their advantages.
  - (c) Market facilities.
  - (d) Means of transport and communication system.
  - (e) Sector in which the firm works i.e., private or public sector etc.
  - (f) Government policy as regard to: (i) Imports and Exports
  - (g) Tax considerations.
  - (h) Availability of labour and its organisation.
  - (i) Area in which it is situated such as backward, rural sub-urban, etc.,



## FINANCING OF WORKING CAPITAL

### Accruals

The major accrual items are wages and taxes. These are simply what the firm owes to its employees and to the government.

### Trade Credit

Trade Credit is the credit given by one business firm to the other arising from credit sales. It is recorded as an accounts receivable (debtor) by the selling firm and as an accounts payable (creditor) by the buying firm.

Trade credit represents the credit extended by the supplier of goods and services. It is a spontaneous source of finance in the sense that it arises in the normal transactions of the firm without specific negotiations, provided the firm is considered creditworthy by its supplier. It is an important source of finance representing 25% to 50% of short-term financing.

### Working capital advance by commercial banks

Working capital advance by commercial banks represents the most important source for financing current assets.

**Forms of Bank Finance:** Working capital advance is provided by commercial banks in three primary ways: (i) cash credits / overdrafts, (ii) loans, and (iii) purchase / discount of bills. In addition to these forms of direct finance, commercial banks help their customers in obtaining credit from other sources through the letter of credit arrangement.

**Cash Credit / Overdrafts:** Under a cash credit or overdraft arrangement, a pre-determined limit for borrowing is specified by the bank. The borrower can draw as often as required provided the out standings do not exceed the cash credit / overdraft limit.

**Loans:** These are advances of fixed amounts which are credited to the current account of the borrower or released to him in cash. The borrower is charged with interest on the entire loan amount, irrespective of how much he draws.

**Purchase / Discount of Bills:** A bill arises out of a trade transaction. The seller of goods draws the bill on the purchaser. The bill may be either clean or documentary (a documentary bill is supported by a document of title to goods like a railway receipt or a bill of lading) and may be payable on demand or after a usance period which does not exceed 90 days. On acceptance of the bill by the purchaser, the seller offers it to the bank for discount / purchase. When the bank discounts / purchases the bill it releases the funds to the seller. The bank presents the bill to the purchaser (the acceptor of the bill) on the due date and gets its payment.

**Letter of Credit:** Letter of Credit is a formal document issued by a bank on behalf of customer, mentioning the conditions under which the bank will honour the commitments of the customer. A letter of credit is an arrangement whereby a bank helps its customer to obtain credit from its (customer's) suppliers. When a bank opens a letter of credit in favour of its customer for some specific purchases, the bank undertakes the responsibility to honour the obligation of its customer, should the customer fails to do so.

### Regulation of Bank Finance

Concerned about such a distortion in credit allocation, the Reserve Bank of India (RBI) has been trying, particularly from the mid 1960s onwards, to bring a measure of discipline among industrial borrowers and to redirect credit to the priority sectors of the economy. From time to time, the RBI issue guidelines and directives relating to matters like the norms for inventory and receivables, the Maximum Permissible Bank Finance, the form of assistance, the information and reporting system, and the credit monitoring



mechanism. The important guidelines and directives have stemmed from the recommendations of various committees such as the Dehejia Committee, the Tandon Committee, the Chore Committee, and the Marathe Committee.

However, in recent years, in the wake of financial liberalisation, the RBI has given freedom to the boards of individual banks in all matters relating to working capital financing.

From the mid-eighties onwards, special committees were set up by the RBI to prescribe norms for several other industries and revise norms for some industries covered by the Tandon Committee.

### **Public Deposits**

Many firms, large and small, have solicited unsecured deposits from the public in recent years, mainly to finance their working capital requirements.

### **Inter-corporate Deposits**

A deposit made by one company with another, normally for a period up to six months, is referred to as an inter-corporate deposit. Such deposits are usually of three types.

**Call Deposits:** In theory, a call deposit is withdrawal by the lender on giving a day's notice. In practice, however, the lender has to wait for at least three days. The interest rate on such deposits may be around 10 percent per annum.

**Three-months Deposits:** More popular in practice, these deposits are taken by borrowers to tide over a short-term cash inadequacy that may be caused by one or more of the following factors: disruption in production, excessive imports of raw material, tax payment, delay in collection, dividend payment, and unplanned capital expenditure. The interest rate on such deposits is around 12 percent per annum.

**Six-months Deposits:** Normally, lending companies do not extend deposits beyond this time frame. Such deposits, usually made with first-class borrowers, carry an interest rate of around 15 percent per annum.

### **Short-term loans from financial institutions**

The Life Insurance Corporation of India and the General Insurance Corporation of India provide short-term loans to manufacturing companies with an excellent track record.

### **Rights debentures for working capital**

Public limited companies can issue "Rights" debentures to their shareholders with the object of augmenting the long-term resources of the company for working capital requirements. The key guidelines applicable to such debentures are as follows:

The amount of the debenture issue should not exceed (a) 20% of the gross current assets, loans, and advances minus the long-term funds presently available for financing working capital, or (b) 20% of the paid-up share capital, including preference capital and free reserves, whichever is the lower of the two.

The debt-equity ratio, including the proposed debenture issue, should not exceed 1:1.

The debentures shall first be offered to the existing Indian resident shareholders of the company on a pro rata basis.

### **Commercial paper**

Commercial paper is an unsecured, short-term promissory note issued by highly reputed and credit rated companies, mostly on a discount basis. Generally, large firms with considerable financial strength are able to issue commercial paper. The important features of commercial paper are as follows:

The maturity period of commercial paper usually ranges from 90 days to 360 days.



Commercial paper is sold at a discount from its face value and redeemed at its face value. Hence the implicit interest rate is a function of the size of the discount and the period of maturity.

Commercial paper is either directly placed with investors who intend holding it till its maturity. Hence there is no well developed secondary market for commercial paper.

### **Factoring**

Factoring is a system of selling receivables to a financial institution or a factor usually on a 'non-recourse' basis. Factoring, as a fund based financial service, provides resources to finance receivables as well as facilitates the collection of receivables. It is another method of raising short-term finance through account receivable credit offered by commercial banks and factors. A commercial bank may provide finance by discounting the bills or invoices of its customers. Thus, a firm gets immediate payment for sales made on credit. A factor is a financial institution which offers services relating to management and financing of debts arising out of credit sales. Factoring is becoming popular all over the world on account of various services offered by the institutions engaged in it. Factors render services varying from bill discounting facilities offered by commercial banks to a total take-over of administration of credit sales including maintenance of sales ledger, collection of accounts receivables, credit control and protection from bad debts, provision of finance and rendering of advisory services to their clients. Factoring, may be on a recourse basis, where the risk of bad debts is borne by the client, or on a non-recourse basis, where the risk of credit is borne by the factor.

At present, factoring in India is rendered by only a few financial institutions on a recourse basis. However, the Report of the Working Group on Money Market (Vaghul Committee) constituted by the Reserve Bank of India has recommended that banks should be encouraged to set up factoring divisions to provide speedy finance to the corporate entities.

In spite of many services offered by factoring, it suffers from certain limitations. The most critical fall outs of factoring include (i) the high cost of factoring as compared to other sources of short-term finance, (ii) the perception of financial weakness about the firm availing factoring services, and (iii) adverse impact of tough stance taken by factor, against a defaulting buyer, upon the borrower resulting into reduced future sales.

### **Tandon Committee Report**

The recommendations of the Dehejia Committee regarding plugging the loop holes in the existing credit system and change in the lending policy of the banks remained unimplemented. As a result banks 'oversold credit' and large part of it remained unutilised. There was no exchange of information between the banks and the customer.

A committee was, therefore, appointed by the Reserve Bank in July, 1974, under the chairmanship of Shri P.L. Tandon, then Chairman of the Punjab National Bank.

The salient features of the recommendations of the committee are being summarised below:

1. **Fixation of norms:** The important feature of the Tandon Committee's recommendations relate to fixation of norms for bank lending to industry. These norms can be divided into two categories:

- (a) Inventory and receivables norms covering 15 major industries for (i) Raw material; (ii) Stocks in process; (iii) Finished Goods; and (iv) Receivables and bills discounted.
- (b) Lending norms of which there are three alternatives, (i) the method under which the borrower will have to contribute a minimum of 25% of the working capital gap from long-term funds, i.e., owned funds and term borrowings. This will give a ratio of 1.17:1 (ii) second, method under which the borrower has to provide the minimum of 25% of the total current assets and that will give a current ratio of 1.33:1; (iii) third method, under which the borrower's contribution from long-term funds will be to the extent of the entire core current assets and a minimum of 25% of the balance of the current assets The above three methods of Tandon Committee norms may be explained by the following example.



Given	1. Current Assets	₹ 20,000
	2. Current Liabilities other than borrowings	₹ 15,000
	3. Core Current Assets	₹ 2,000

Then the permissible bank borrowings under the three methods is as follows:

$$\begin{aligned}\text{Method I} &= 0.75 (\text{Current Assets} - \text{Current Liabilities}) \\ &= 0.75 (20,000 - 5,000) \\ &= ₹ 11,250\end{aligned}$$

$$\begin{aligned}\text{Method II} &= 0.75 (\text{Current Assets}) - \text{Current Liabilities} \\ &= (0.75 \times 20,000) - 5,000 \\ &= ₹ 10,000\end{aligned}$$

$$\begin{aligned}\text{Method III} &= 0.75 (\text{Current Assets} - \text{Core Current Assets}) - \text{Current Liabilities} \\ &= 0.75 (20,000 - 2,000) - 5,000 \\ &= ₹ 8,500\end{aligned}$$

### Chore Committee Report

Having implemented the recommendations of the Tandon Committee, the Reserve Bank of India in March, 1979, appointed another committee under the chairmanship of Shri K.B. Chore, Chief Officer, Department of Banking Operation and Development, Reserve Bank of India. The important points in the findings of the committee are as follows:

- (i) Continuance of the existing three lending systems of Tandon Committee.
- (ii) No bifurcation of cash credit accounts.
- (iii) Fixation of separate limits for peak level, non-peak level requirements.
- (iv) Submission of quarterly statements by even small borrowers.
- (v) Borrowers should be discouraged from approaching banks frequently for adhoc or temporary limits in excess of sanctioned limits to meet unforeseen contingencies.
- (vi) The overdependence on bank credit by medium/large borrowers is sought to be reduced by requiring them to enhance their contribution towards Working Capital.
- (vii) The data relating to Working Capital and its allied ratios based on various journals, RBI reports etc., relating to private industries, engineering industries etc., are given.

### Illustration 1

A company has prepared its annual budget, relevant details of which are reproduced below:

(a) Sales ₹ 46.80 lakhs (25% cash sales and balance on credit)	78,000 units
(b) Raw material cost	60% of sales value
(c) Labour cost	₹ 6 per unit
(d) Variable overheads	₹ 1 per unit
(e) Fixed overheads	₹ 5 lakhs (including ₹ 1,10,000 as depreciation)



(f) Budgeted stock levels:	
Raw materials	3 weeks
Work-in-progress	1 week (Material 100%, Labour & overheads 50%)
Finished goods	2 weeks
(g) Debtors are allowed credit for 4 weeks	
(h) Creditors allow 4 weeks credit	
(i) Wages are paid bi-weekly, i.e. by the 3rd week and by the 5th week for the 1st & 2nd weeks and the 3rd & 4th weeks respectively	
(j) Lag in payment of overheads	2 weeks
(k) Cash-in-hand required	₹ 50,000

Prepare the Working Capital budget for a year for the company, making whatever assumptions that you may find necessary.

**Solution:**

Unit Selling Price and Cost	(₹)
Selling price (46,80,000 ÷ 78,000)	60
Cost:	
Raw materials (60% of 46,80,000 ÷ 78,000)	36
Labour	6
Variable overheads	1
Fixed overheads (excluding depreciation)	5
Total Cost per unit	48

Statement showing Working Capital Requirement

Current Assets		(₹)
Raw materials	(78,000 units x ₹ 36 x 3/52)	1,62,000
Work-in-progress	(78,000 units x ₹ 42 x 1/52)	63,000
Finished goods	(78,000 units x ₹ 48 x 2/52)	1,44,000
Debtors	(78,000 units x ₹ 60 x 75/100 x 4/52)	2,70,000
Cash in hand		50,000
	(a)	6,89,000
Current Liabilities		
Creditors	(78,000 units x ₹ 36 x 4/52)	2,16,000
Lag in wages	(78,000 units x ₹ 6 x 2/52)	18,000
Lag in payment of overheads	(78,000 units x ₹ 6 x 2/52)	18,000
	(b)	2,52,000
Net working capital required	(a) – (b)	4,37,000

**Note:**

- Total sales for 4 weeks is 6,000 units. Excluding 25% cash sales, credit sales amounts to 4,500 units.
- One year is assumed to be of 52 weeks.

**Illustration 2**

A company plans to manufacture and sell 400 units of a domestic appliance per month at a price of ₹ 600 each. The ratio of costs to selling price are as follows:

	(% of selling price)
Raw materials	30%
Packing materials	10%
Direct labour	15%
Direct expense	5%

Fixed overheads are estimated at ₹ 4,32,000 per annum.

The following norms are maintained for inventory management:

Raw materials	30 days
Packing materials	15 days
Finished goods	200 units
Work-in-progress	7 days

**Other particulars are given below:**

- Credit sales represent 80% of total sales and the dealers enjoy 30 working days credit. Balance 20% are cash sales.
- Creditors allow 21 working days credit for payment.
- Lag in payment of overheads and expenses is 15 working days.
- Cash requirements to be 12% of net working capital.
- Working days in a year are taken as 300 for budgeting purpose.

Prepare a Working Capital requirement forecast for the budget year.

**Solution:**

Selling Price and Cost per unit ₹

Raw materials	(₹ 600 x 30/100)	180
Packing materials	(₹ 600 x 10/100)	60
Direct labour	(₹ 600 x 15/100)	90
Direct expenses	(₹ 600 x 5/100)	30
Fixed overheads	[₹ 4,32,000 / (400 x 12)]	90
Total cost		450
Profit		150
Selling Price per unit		600





Forecast of Working Capital Requirement:

₹

<b>Current Assets</b>		
Raw materials stock	(₹ 4800 x 180 x 30/300)	86,400
Packing materials stock	(₹ 4800 x 60 x 15/300)	14,400
Working in progress	(₹ 4800 x 285 x 7/300)	31,920
Finished goods stock	(₹ 450 x 200 units)	90,000
Debtors	(₹ 4800 x 80/100 x ₹ 600 x 30/300)	2,30,400
(a)		4,53,120
<b>Current Liabilities:</b>		
Creditors for raw material suppliers	(₹ 4800 x 180 x 21/300)	60,480
Creditors for packing material	(₹ 4800 x 60 x 21/300)	20,160
Creditors for expenses and overheads	(₹ 4800 x 120 x 15/300)	28,800
(b)		1,09,440
Net Working Capital	(a) – (b)	3,43,680
Add: Cash required (12% of net working capital)		41,242
Total Working Capital Required		3,84,922

**Note:**

- Work in progress is valued with raw material cost at 100% and 50% of wages, overheads and expenses.
- Debtors are valued at selling price.

**Illustration 3**

A Company provided the following data:

	Cost per unit (₹)
Raw materials	52.00
Direct labour	19.50
Overheads	39.00
Total Cost	110.50
Profit	19.50
Selling Price	130.00

The following additional information is available:

- Average raw materials in stock: one month.
- Average materials in process: half-a-month
- Average finished goods in stock: one month
- Credit allowed by suppliers: one month
- Credit allowed to debtors: two months.
- Time lag in payment of wages: one and a half weeks.
- Overheads: one month



- (h) One-fourth of sales are on cash basis.  
(i) Cash balance is expected to be ₹ 1,20,000.

You are required to prepare a statement showing the Working Capital needed to finance a level of activity of 70,000 units of annual output. The production is carried throughout the year on even basis and wages and overheads accrue similarly. (Calculation be made on the basis of 30 days a month and 52 weeks a year).

**Solution:****Statement showing estimate of Working Capital**

<b>Current Assets</b>	(₹)	(₹)
Stock of Raw material (70,000 units x 52 x 30/360)		3,03,333
Work-in-progress:		
Raw materials (70,000 units x 52 x 15/360)	1,51,667	
Direct labour (70,000 units x 19.50 x 30/360 x 1/4)	28,437	
Overheads (70,000 units x 39 x 30/360 x 1/4)	56,875	2,36,979
Stock of finished goods (70,000 units x 110.50 x 30/360)		6,44,583
Debtors (70,000 units x 130 x 60/360)		15,16,667
Cash balance		1,20,000
	(a)	28,21,562
<b>Current Liabilities:</b>		
Creditors for raw material (70,000 units x 52 x 30/360)		3,03,333
Creditors for wages (70,000 units x 19.50 x 1.5/52)		39,375
Creditors for overheads (70,000 units x 39 x 30/360)		2,27,500
	(b)	5,70,208
Net Working Capital	(a) – (b)	22,51,354

**Illustration 4**

From the following data, compute the duration of the operating cycle for each of years:

	Year1 (₹)	Year 2 (₹)
Stock:		
Raw materials	20,000	27,000
Work-in-progress	14,000	18,000
Finished goods	21,000	24,000
Purchases	96,000	1,35,000
Cost of goods sold	1,40,000	1,80,000
Sales	1,60,000	2,00,000
Debtors	32,000	50,000
Creditors	16,000	18,000

Assume 360 days per year for computational purposes.

**Solution:**

Calculation of operating cycle

	Year 1	Year 2
<b>Current Assets:</b>		
1. Raw material stock = $\frac{\text{Stock of raw material}}{\text{Purchases}} \times 360$	$(20 / 96) \times 360 = 75$ days	$(27 / 135) \times 360 = 72$ days
2. WIP turnover = $(\text{WIP} / \text{COGS}) \times 360$	$(14 / 140) \times 360 = 36$ days	$(18 / 180) \times 360 = 36$ days
3. Finished goods turnover = $(\text{Finished good} / \text{COGS}) \times 360$	$(21 / 140) \times 360 = 54$ days	$(24 / 180) \times 360 = 48$ days
4. Debtors turnover = $(\text{Debtors} / \text{Sales}) \times 360$	$(32 / 160) \times 360 = 72$ days	$(50 / 200) \times 360 = 90$ days
Total (A)	237 days	246 days
Creditors period = $(\text{Creditors} / \text{Purchases}) \times 360$	$(16 / 96) \times 360 = 60$ days	$(18 / 135) \times 360 = 48$ days
Total (B)	60 days	48 days
Operating cycle (A-B)	177 days	198 days

**Illustration 5**

(a) From the following details, prepare an estimate of the requirement of Working Capital:

Production	60,000 units
Selling price per unit	₹ 5
Raw material	60% of selling price
Direct wages	10% of selling price
Overheads	20% of selling price
Materials in hand	2 months requirement
Production Time	1 month
Finished goods in Stores	3 months
Credit for Material	2 months
Credit allowed to Customers	3 months
Average Cash Balance	₹ 20,000

Wages and overheads are paid at the beginning of the month following/In production all the required materials are charged in the initial stage and wages and overheads accrue evenly.

(b) What is the effect of Double Shift Working on the requirement of Working capital?

**Solution:**

(a) Computation of requirement of Working Capital

Annual production      60,000 units

Monthly production      5,000 units



## Unit Cost Sheet

Particulars		(₹)
Selling price		5.00
Cost of Raw Material	60% of 5=3.00	
Wages	10% of 5=0.50	
Overheads	20% of 5=1.00	
Total cost per unit		4.50
Profit per unit		0.50

Current Assets:		(₹)	(₹)
Stock of Raw material	$3 \times 60,000 \times \frac{2}{12}$		30,000
Work in Progress:			
Raw Materials	$1 \ 3 \times 60,000 \times \frac{1}{12}$	15,000	
Wages + Overheads	$1.50 \times 60,000 \times \frac{1}{12} \times \frac{1}{2}$	3,750	18,750
Stock of Finished Goods	$4.50 \times 60,000 \times \frac{3}{12}$		67,500
Debtors (on sales)	$5.00 \times 60,000 \times \frac{3}{12}$		75,000
Cash			20,000
Total Current Assets	(A)		2,11,250

Current Liabilities:		
Creditors	$3 \times 60,000 \times \frac{2}{12}$	30,000
Outstanding wages	$0.5 \times 60,000 \times \frac{1}{12}$	2,500
Outstanding overheads	$1 \times 60,000 \times \frac{1}{12}$	5,000
Total Current Liabilities (B)		37,500

Working Capital: (A-B) = 2,11,250 – 37,500 = ₹ 1,73,750



## (b) Effects of Double shift working:

The following assumptions are made before estimating the Working Capital requirement for double shift working:

1. Production will be 10000 units per month or 1,20,000 units per year.
2. Materials may not be required at double rate. Due to inventory control measures it may be taken as 2/3
3. WIP will be the same at 5000 units. This will not increase as WIP of first shift will be handed over to second shift.
4. 50% of overheads are assumed as fixed. This will not increase due to double shift working.

On the basis of above assumptions, the following capital requirement is estimated as follows:

Current Assets:			(₹)
Stock of Raw material		$30,000 + 30000 \times \frac{2}{3}$	50,000
Work in Progress:			
Raw materials	$3 \times 60,000 \times \frac{2}{3}$	15,000	
Wages + Overheads	$**1.25 \times 60,000 \times \frac{1}{12} \times \frac{1}{2}$	3,125	18,125
Stock of finished Goods	$4.25 \times 1,20,000 \times \frac{3}{12}$		1,27,500
Debtors (on sales)	$5.00 \times 1,20,000 \times \frac{3}{12}$		1,50,000
Cash (double)			40,000
Total Current Assets	(A)		3,85,625

Current liabilities:			(₹)
Creditors		$3 \times 1,20,000 \times \frac{1}{2}$	60,000
Outstanding wages	$0.5 \times 1,20,000 \times \frac{1}{2}$		5,000
Outstanding overheads (Fixed Overheads remain same)		2,500	
(Variable Overheads double as before)		5,000	7,500
Total Current Liabilities (B)			72,500

Working Capital required for two shifts: (A-B) = 3,85,625 – 72,500 = ₹ 3,13,125

Therefore additional working capital required for second shift = 3,13,125 – 1,73,750 = ₹ 1,39,375

\*\* Calculation of Cost per unit



₹

	Single shift	Double shift
Raw material Cost	3.00	3.00
Wages	0.50	0.50
Overhead expenses:		
Fixed	0.50	0.25
Variable	0.50	0.50
Cost per unit	4.50	4.25

→ Production in 2 shifts are doubled

**Illustration 6**

Estimate the requirement of total capital of the following project with an estimated production of 250 m/t per annum of chemical X, presently imported and which can be entirely sold at the rate of its landed cost of ₹ 8,500 per m/t. You are also required to find out.

- Percentage of yield on investment;
- Percentage of profit on sales;
- Rate of cash generation per annum before tax.

Details of the proposed project for expected production of 250 m/t are as under:

(i) Investment	
Land	₹ 1,00,000
Building	₹ 8,00,000
Plant and Machinery	₹ 12,00,000
(ii) Cost of Production (p.a.)	
Imported Raw Material	₹ 6,50,000
Indigenous Raw Material	₹ 6,26,000
Salaries and Wages	₹ 1,35,000
Repairs and Maintenance on Plant Cost	5%
on Building	2%
Depreciation on Plant cost	7%
on Building Cost	2 ½ %
Administrative and other expenses	₹ 50,000
Steam requirement 7,000 m/t	@ ₹ 16 per m/t
Power	₹ 6,000
Packing Drums (of 500 kg. capacity)	₹ 30 each
(iii) Working Capital requirement	
Imported Raw Material stock	6 months
Indigenous Raw Material and Packing Material stock	3 months
Stock of Finished Products	1 month
Credit to Customers	1 month
Credit from suppliers (only on Indigenous Raw Material and Packing Material)	1 month
Cash expenses	1 month

**Solution:**

Working notes:

1. Packing of drums of 500g each. It is assumed of 500kg each.

Cost of production per annum (production of chemical x - 250m/t).

		₹ in lakhs
Imported Raw Material		6.50
Indigenous Raw Material		6.26
Salaries & Wages		1.35
Repairs and Maintenance : 5% on 12,00,000 2% on 8,00,000	0.60 0.16	0.76
Depreciation 7 % on 12,00,000 2.5 % on 8,00,000	0.84 0.20	1.04
Administration & Other Expenses		0.50
Steam	7000 x 16	1.12
Power		0.06
Packing drums (250 m/t) / 500 kg. = 500 nos. @ 30 each		0.15
Total Cost		17.74
Sales	250 x 8500	21.25
Profit		3.51

2. Working Capital requirement

Particulars	Basis of calculation	Amount (₹)
Imported Raw Material stock	$(6 / 12) \times 6.5$	3.25
Indigenous Raw Material and Packing Material	$6.26 + 0.15 = 6.41 \times (3 / 12)$	1.60
Stock of finished goods	At works cost excluding depreciation & admin exp = $17.74 - 1.04 - 0.5 = (16.20/12)$	1.35
Credit to customers	$17.74 - 1.04 = (16.70 / 12)$	1.39
Cash Expenses	Salaries, wages, repairs, admin, steam, power = $3.79/12$	0.32
Current Assets		7.91
(Less): Credit from suppliers	$6.41 / 12$	0.53
Working Capital requirement		7.38

Requirement of Total Capital:

	(₹)
Land	1.00
Building	8.00
Plant and Machinery	12.00
Working Capital	7.38
	28.38



- (i) percentage of yield on investment = Profit / Investment x 100  
 = (3.51 / 28.38) x 100  
 = 12.37 %
- (ii) percentage of profit on sales = Profit / Sales x 100  
 = (3.51 / 21.25) x 100  
 = 16.52 %
- (iii) cash generation per annum before tax :

	(₹)
PBT	3.51
Add. Depreciation	1.04
Cash generation before tax	4.55

$$\text{Rate} = (4.55 / 28.38) \times 100 = 16.03 \%$$

### Illustration 7

Solaris Ltd. sells goods in domestic market at a gross profit of 25 percent, not counting on depreciation as a part of the 'cost of goods sold'. Its estimates for next year are as follows:

Amount (₹ in lakhs)

Sales - Home at 1 month's credit	1,200
Exports at 3 months' credit, selling price 10 percent below home price	540
Materials used (suppliers extend 2 months' credit)	450
Wages paid, ½ month in arrears	360
Manufacturing expenses, paid 1 month in arrears	540
Administrative expenses, paid 1 month in arrears	120
Sales promotion expenses (payable quarterly - in advance)	60
Income - tax payable in 4 instalments of which one falls in the next financial year	150

The company keeps 1 month's stock of each of raw materials and finished goods and believes in keeping ₹20 lakh as cash. Assuming a 15 percent safety margin, ascertain the estimated Working Capital requirement of the company (ignore work-in-process).

### Solution:

Statement showing determination of Working Capital

(Amount in ₹ lakhs)

Current assets	(₹)	Computation
Cash	20.00	
Raw Material	37.50	(450 lakhs / 12)
Finished Goods	122.50	(1,470 lakhs / 12)
Debtors Domestic market	100.00	(1,200 / 12)
Export market	135.00	(540 x 3 / 12)
Sales promotion expense	15.00	3 (60 lakhs x 3 / 12)
Total Current Assets (A)	430.00	





Current Liabilities	(₹)
Raw Materials (450 x 2 / 12)	75.00
Wages (360 / 24)	15.00
Manufacturing expenses (540 / 12)	45.00
Administration expenses (120/12)	10.00
Total Current Liabilities (B)	145.00
Net Current Assets	285.00
Add: Safety margin @ 15%	42.75
Working Capital Requirement	327.75

**Working notes:**

## 1. Cost of Production

	₹ in lakhs
Material used	450
Wages paid	360
Manufacturing exp	540
Administration exp	120
Total	1470

2. Tax aspect is ignored as it is to be paid out of profits.

**Illustration 8**

Camellia Industries Ltd. is desirous of assessing its Working Capital requirements for the next year. The finance manager has collected the following information for the purpose.

Estimated cost per unit of finished product	(₹)
Raw materials	90
Direct labour	50
Manufacturing and administrative overhead (Excluding depreciation)	40
Depreciation	20
Selling overheads	30
Total Cost	230

The product is sold at ₹ 300 per unit.

Additional information:

- (i) Budgeted level of activity is 1,20,000 units of output for the next year.
- (ii) Raw material cost consists of the following:
 

Pig iron	65 per unit
Ferro alloys	15 per unit
Cast iron borings	10 per unit



- (iii) Raw materials are purchased from different suppliers, extending different credit period.  
Pig iron 2 months  
Ferro alloys  $\frac{1}{2}$  months  
Cast iron borings 1 month.
- (iv) Product is in process for a period of  $\frac{1}{2}$  month. Production process requires full unit (100 percent) of pig iron and ferroalloys in beginning of production. Cast iron boring is required only to the extent of 50 percent in the beginning and the remaining is needed at a uniform rate during the process. Direct labour and other overheads accrue similarly at a uniform rate throughout production process.
- (v) Past trends indicate that the pig iron is required to be stored for 2 months and other materials for 1 month.
- (vi) Finished goods are in stock for a period of 1 month.
- (vii) It is estimated that one-fourth of total sales are on cash basis and the remaining sales are on credit. The past experience of the firm has been to collect the credit sales in 2 months.
- (viii) Average time-lag in payment of all overheads is 1 month and  $\frac{1}{2}$  month in the case of direct labour.
- (ix) Desired cash balance is to be maintained at ₹ 10 lakh.

You are required to determine the amount of Net Working Capital of the firm. State your assumptions, if any.

### Solution:

Determination of net working capital of Ram Industries Ltd

Current Assets		(₹)
Minimum desired cash balance	10,00,000	
Raw Materials :		
Pig iron	13,00,000	[1,20,000 x 65 x (2 / 12)]
Ferry alloys	1,50,000	[1,20,000 x 15 x (1 / 12)]
Cast iron borings	1,00,000	[1,20,000 x 10 x (1 / 12)]
WIP	6,62,500	[1,20,000 x 132.5 (1/24)]
Finished goods	18,00,000	[1,20,000 x 180 x (1 / 12)]
Debtors	60,00,000	[1,20,000 x 300 x (2/12)]
Total Current Assets: (A)	1,00,12,500	
Current liabilities		(₹)
Creditors:		
Pig iron	13,00,000	[1,20,000 x 65 x (2/12)]
Ferry alloys	75,000	[1,20,000 x 15 x (1 / 24)]
Cast iron borings	1,00,000	[1,20,000 x 10 x (1 / 12)]
Outstanding Wages	2,50,000	[1,20,000 x 50 x (1 / 24 )]
Outstanding Total Over heads	7,00,000	[1,20,000 x 70 x (1 / 12)]
Total current liabilities (B)	24,25,000	

Working Capital (A-B) = 1,00,12,500 – 24,25,000 = 75,87,500

**Working Notes:**

Particulars	Amount (₹)	Amount (₹)
*Determination of Work in Process		
Pig iron		65.00
Ferry alloys		15.00
Cast iron borings (0.5 × 10)		5.00
Other costs		
Cast iron borings	2.50	
Direct Labour (0.5 x 50)	25.00	
Manufacturing and administration Overheads (0.5x40)	20.00	47.50
		132.50

**Illustration 9**

Compute "Maximum Bank Borrowings" permissible under Method I, II & III of Tandon Committee norms from the following figures and comment on each method.

Current Liabilities	₹ in lakhs	Current assets	₹ in lakhs
Creditors for purchases	200	Raw materials	400
Other current liabilities	100	Work in progress	40
Bank borrowings including bills discounted with bankers	400	Finished goods	180
		Receivable including bills discounted with bankers	100
		Other current assets	20
	700		740

Assume core current assets are ₹190 lakhs.

**Solution:**

TANDON Committee norms

**Method 1**

Under Method 1 the proprietor should contribute 25% of Working Capital Gap from their long term source of finance and the balance is the Maximum Permissible Bank Borrowings.

Working Capital Gap means:

Working Capital Gap = Current Assets - Current Liabilities (except bank borrowings)

In the given problem

	₹ in lakhs
Total Current Assets	740
Less: Current liabilities excluding bank borrowings	300
Working Capital Gap	440
Less: Contribution from long term source of finance (25%)	110
Maximum Permissible Bank Borrowings	330



**Comment:** Maximum Permissible Bank Borrowings under method 1 is ₹.330 lakhs. But existing bank borrowing is ₹ 400 lakhs.

Therefore the excess bank borrowings of ₹ 70 lakhs convert into term loan.

### Method 2

Under Method 2 the proprietor should contribute 25% of Current Assets from their long term source of finance and the balance is the Maximum Permissible Bank Borrowings.

In the given problem

	₹ in lakhs
Total Current Assets	740
Less: Current liabilities excluding bank borrowings	300
Working Capital Gap	440
Less: Contribution from long term source of finance (25% of 740)	185
Maximum Permissible Bank Borrowings	255

**Comment:** Maximum Permissible Bank Borrowings under method 2 is ₹ 255 lakhs. But existing bank borrowing is ₹ 400 lakhs.

Therefore the excess bank borrowings of ₹ 145 lakhs convert into term loan.

### Method 3

Under Method 3 the proprietor should contribute the entire investment in Core Current Assets and 25% of remaining current assets from their long term source of finance and the balance is the Maximum Permissible Bank Borrowings.

In the given problem

	₹ in lakhs
Total Current Assets	740
Less: Current liabilities excluding bank borrowings	300
Working Capital Gap	440
Less: Contribution from long term source of finance (190+ 25% of (740-190))	328
Maximum permissible bank borrowings	112

**Comment:** Maximum permissible bank borrowings under method 3 is ₹ 112 lakhs. But existing bank borrowing is ₹ 400 lakhs.

Therefore the excess bank borrowings of ₹ 288 lakhs convert into term loan.

## 8.2 INVENTORY MANAGEMENT

Inventory constitutes an important item in the working capital of many business concerns. Net working capital is the difference between current assets and current liabilities. Inventory is a major item of current assets. The term inventory refers to the stocks of the product a firm is offering for sale and the components that make up the product. Inventory is stores of goods and stocks. This includes raw materials, work-in-process and finished goods. Raw materials consist of those units or input which are used to manufacture goods that require further processing to become finished goods. Finished goods are products ready for sale. The classification of inventory and the levels of the components vary from organisation to organisation depending upon the nature of business. For example steel is a finished product for a steel industry, but raw material for an automobile manufacturer. Thus, inventory may be



defined as "Stock of goods that is held for future use". Since inventory constitute about 50 to 60 percent of current assets, the management of inventories is crucial to successful Working Capital Management. Working capital requirements are influenced by inventory holding. Hence, there is a need for effective and efficient management of inventory

A good inventory management is important to the successful operations of the most of the organizations, unfortunately the importance of inventory is not always appreciated by top management. This may be due to a failure to recognize the link between inventory and achievement of organisational goals or due to ignorance of the impact that inventory can have on costs and profits.

Inventory management refers to an optimum investment in inventory. It should neither be too low to effect the production adversely nor too high to block the funds unnecessarily. Excess investment in inventory is unprofitable for the business. Both excess and inadequate investment in inventory is not desirable. The firm should operate within the two danger points. The purpose of inventory management is to determine and maintain the optimum level of inventory investment.

### Techniques of Inventory Control

1. Economic Order Quantity
2. Fixing Levels of Material
  - (a) Minimum Level
  - (b) Maximum Level
  - (c) Reorder Level
  - (d) Danger Level
3. ABC Inventory Control
4. Perpetual Inventory System
5. VED classification
6. Just-In-Time
7. FSN Analysis
8. Inventory Turnover Ratio

## 8.3 MANAGEMENT OF RECEIVABLES

Receivables mean the book debts or debtors and these arise, if the goods are sold on credit. Debtors form about 30% of current assets in India. Debt involves an element of risk and bad debts also. Hence, it calls for careful analysis and proper management. The goal of Receivables Management is to maximize the value of the firm by achieving a trade off between risk and profitability.

The objectives of Receivables Management are as follows:

- (a) To obtain optimum (non-maximum) value of sales;
- (b) To control the cost of receivables, cost of collection, administrative expenses, bad debts and opportunity cost of funds blocked in the receivables.
- (c) To maintain the debtors at minimum according to the credit policy offered to customers.
- (d) To offer cash discounts suitably depending on the cost of receivables, bank rate of interest and opportunity cost of funds blocked in the receivables.



### Costs of Maintaining Receivables

The costs with respect to maintenance of receivables can be identified as follows:

**Capital costs:** Maintenance of accounts receivable results in blocking of the firm's financial resources in them. This is because there is a time lag between the sale of goods to customers and the payments by them. The firm has, therefore, to arrange for additional funds to meet its own obligations, such as payment to employees, suppliers of raw materials, etc.

**Administrative costs:** The firm has to incur additional administrative costs for maintaining accounts receivable in the form of salaries to the staff kept for maintaining accounting records relating to customers, cost of conducting investigation regarding potential credit customers to determine their credit worthiness etc.

**Collection costs:** The firm has to incur costs for collecting the payments from its credit customers. Sometimes, additional steps may have to be taken to recover money from defaulting customers.

**Defaulting costs:** Sometimes after making all serious efforts to collect money from defaulting customers, the firm may not be able to recover the overdues because of the inability of the customers. Such debts are treated as bad debts and have to be written off since they cannot be realised.

### Benefits of Maintaining Receivables

**Increase in Sales:** Except a few monopolistic firms, most of the firms are required to sell goods on credit, either because of trade customers or other conditions. The sales can further be increased by liberalizing the credit terms. This will attract more customers to the firm resulting in higher sales and growth of the firm.

**Increase in Profits:** Increase in sales will help the firm (i) to easily recover the fixed expenses and attaining the break-even level, and (ii) increase the operating profit of the firm. In a normal situation, there is a positive relation between the sales volume and the profit.

**Extra Profit:** Sometimes, the firms make the credit sales at a price which is higher than the usual cash selling price. This brings an opportunity to the firm to make extra profit over and above the normal profit.

### Factors Affecting the size of receivables

The size of accounts receivable is determined by a number of factors. Some of the important factors are as follows:

**Level of sales:** This is the most important factor in determining the size of accounts receivable. Generally in the same industry, a firm having a large volume of sales will be having a larger level of receivables as compared to a firm with a small volume of sales.

**Credit policies:** A firm's credit policy, as a matter of fact, determines the amount of risk the firm is willing to undertake in its sales activities. If a firm has a lenient or a relatively liberal credit policy, it will experience a higher level of receivables as compared to a firm with a more rigid or stringent credit policy.

**Terms of trade:** The size of the receivables is also affected by terms of trade (or credit terms) offered by the firm. The two important components of the credit terms are (i) Credit period and (ii) Cash discount.

### Optimum Size of Receivables

The optimum investment in receivables will be at a level where there is a trade-off between costs and profitability. When the firm resorts to a liberal credit policy, the profitability of the firm increases on account of higher sales. However, such a policy results in increased investment in receivables, increased chances of bad debts and more collection costs. The total investment in receivables increases and, thus, the problem of liquidity is created. On the other hand, a stringent credit policy reduces the profitability but increases the liquidity of the firm. Thus, optimum credit policy occurs at a point where there is a "Tradeoff" between liquidity and profitability as shown in the chart below.

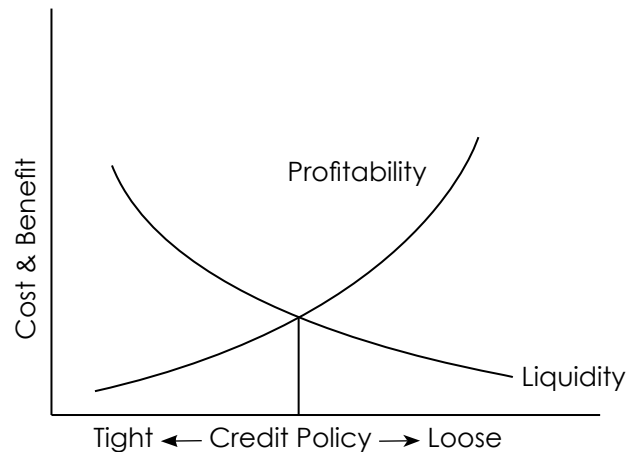

The following are the aspects of credit policy:

- (i) Level of credit sales required to optimise the profit.
- (ii) Credit period i.e. duration of credit, whether it may be 15 days or 30 or 45 days etc.
- (iii) Cash discount, discount period and seasonal offers.
- (iv) Credit standard of a customer : 5 C's of credit :
  - (a) Character of the customer i.e. willingness to pay.
  - (b) Capacity----ability to pay.
  - (c) Capital----financial resources of a customer.
  - (d) Conditions----special conditions for extension of credit to doubtful customers and prevailing economic and market conditions and;
  - (e) Collateral security.
- (v) Profits.
- (vi) Market and economic conditions.
- (vii) Collection policy.
- (viii) Paying habits of customers.
- (ix) Billing efficiency, record-keeping etc.
- (x) Grant of credit----size and age of receivables.

#### 8.4 DETERMINANT OF CREDIT POLICY

##### Optimum credit policy

A firm should establish receivables policies after carefully considering both benefits and costs of different policies. These policies relate to:

- (i) Credit Standards, (ii) Credit Terms, and (iii) Collection Procedures.



Each of these have been explained below:

**(i) Credit Standards**

The term credit standards represent the basic criteria for extension of credit to customers. The levels of sales and receivables are likely to be high if the credit standards are relatively loose, as compared to a situation when they are relatively tight. The firm's credit standards are generally determined by the five "C's". Character, Capacity, Capital, Collateral and Conditions. Character denotes the integrity of the customer, i.e. his willingness to pay for the goods purchased. Capacity denotes his ability to manage the business. Capital denotes his financial soundness. Collateral refers to the assets which the customer can offer by way of security. Conditions refer to the impact of general economic trends on the firm or to special developments in certain areas of economy that may affect the customer's ability to meet his obligations.

Information about the five C's can be collected both from internal as well as external sources. Internal sources include the firm's previous experience with the customer supplemented by its own well developed information system. External resources include customer's references, trade associations and credit rating organizations.

**(ii) Credit terms**

Credit Terms refers to the terms under which a firm sells goods on credit to its customers. As stated earlier, the two components of the credit terms are (a) Credit Period and (b) Cash Discount.

**(iii) Collection procedures**

A stringent collection procedure is expensive for the firm because of high out-of-pocket costs and loss of goodwill of the firm among its customers. However, it minimises the loss on account of bad debts as well as increases savings in terms of lower capital costs on account of reduction in the size of receivables. A balance has therefore to be struck between the costs and benefits of different collection procedures or policies.

**Credit evaluation of customer**

Credit evaluation of the customer involves the following 5 stages:

- (i) *Gathering credit information of the customer through:*
  - (a) financial statements of a firm,
  - (b) bank references,
  - (c) references from Trade and Chamber of Commerce,
  - (d) reports of credit rating agencies,
  - (e) credit bureau reports,
  - (f) firm's own records (Past experience),
  - (g) other sources such as trade journals, Income-tax returns, wealth tax returns, sales tax returns, Court cases, Gazette notifications etc.
- (ii) *Credit analysis* – After gathering the above information about the customer, the credit-worthiness of the applicant is to be analysed by a detailed study of 5 C's of credit as mentioned above.
- (iii) *Credit decision* – After the credit analysis, the next step is the decision to extend the credit facility to potential customer. If the analysis of the applicant is not upto the standard, he may be offered cash on delivery (COD) terms even by extending trade discount, if necessary, instead of rejecting the credit to the customer.
- (iv) *Credit limit* – If the decision is to extend the credit facility to the potential customer, a limit may be prescribed by the financial manager, say, ₹ 25,000 or ₹ 1,00,000 or so, depending upon the credit analysis and credit-worthiness of the customer.





- (v) *Collection procedure* – A suitable and clear-cut collection procedure is to be established by a firm and the same is to be intimated to every customer while granting credit facility. Cash discounts may also be offered for the early payment of dues. This facilities faster recovery.

### 8.5 EVALUATION OF CREDIT POLICY

There are basically two methods of evaluating the credit policies to be adopted by a company – (a) Total Approach and (b) Incremental Approach. The formats for the two approaches are given as under:

**Statement showing the Evaluation of Credit Policies (based on Total Approach)**

Particulars	Present Policy	Proposed Policy I	Proposed Policy II	Proposed Policy III
	₹	₹	₹	₹
<b>A. Expected Profit</b>				
(a) Credit Sales	000	000	000	000
(b) Total Cost other than Bad Debts				
(i) Variable Costs	000	000	000	000
(ii) Fixed Costs	000	000	000	000
	0000	0000	0000	0000
(c) Bad Debts	000	000	000	000
(d) Cash discount				
(e) Expected Net Profit before Tax (a-b-c-d)	000	000	00	000
(f) Less: Tax	000	000	000	000
(g) Expected Profit after Tax	xxxx	xxxx	xxxx	xxxx
<b>B. Opportunity Cost of Investments in Receivables locked up in Collection Period</b>				
<b>Net Benefits (A - B)</b>	xxxx	xxxx	xxxx	xxxx

#### Comment:

The Policy should be adopted since the net benefits under this policy are higher as compared to other policies.

- (i) Total Fixed Cost = [Average Cost per unit - Variable Cost per unit] × No. of units sold on credit under Present Policy

- (iii) Opportunity Cost

$$= \text{Total Cost of Credit Sales} \times \frac{\text{Collection period (Days)}}{365 \text{ (or 360)}} \times \frac{\text{Required Rate of Return}}{100}$$



**Statement showing the Evaluation of Credit Policies (based on Incremental Approach)**

Particulars	Present Policy	Proposed Policy I	Proposed Policy II	Proposed Policy III
	₹	₹	₹	₹
<b>A. Incremental Expected Profit</b>				
Credit Sales	000	000	000	000
(a) Incremental Credit Sales	000	000	000	000
(b) Less: Incremental Costs of Credit Sales				
(i) Variable Costs	000	000	000	000
(ii) Fixed Cost	000	000	000	000
(c) Incremental Bad Debt Losses	000	000	000	000
(d) Incremental Cash Discount	000	000	000	000
(e) Incremental Expected Profit (a-b-c-d)	000	000	000	000
(f) Less: Tax	000	000	000	000
(g) Incremental Expected profit after tax	000	000	000	000
<b>B. Required return on Incremental Investments</b>				
(a) Cost of Credit Sales	000	000	000	000
(b) Collection Period (in days)	----	----	----	----
(c) Investment in Receivable (a × b/365 or 360)	000	000	000	000
(d) Incremental Investment in Receivables	000	000	000	000
(e) Required Rate of Return (in %)	%	%	%	%
(f) Required Return on Incremental Investments (d × e)	000	000	000	000
<b>Incremental Net Benefits (A - B)</b>	xxx	xxx	xxx	xxx

**Comment:**

The Policy ..... should be adopted since net benefits under this policy are higher as compared to other policies.

(i) Total Fixed Cost = [Average Cost per unit - Variable Cost per unit] × No. of units sold on credit under Present Policy

(ii) Opportunity Cost

$$= \text{Total Cost of Credit Sales} \times \frac{\text{Collection period (Days)}}{365 \text{ (or 360)}} \times \frac{\text{Required Rate of Return}}{100}$$

**Illustration 10**

XYZ Corporation whose current sales are in the region of ₹6 lakhs per annum and an average collection period of 30 days wants to pursue a more liberal policy to improve sales. A study made by a management consultant reveals the following information;

Credit Policy	Increase in collection period	Increase in sales	Present default anticipated
A	10 days	₹ 30,000	1.5%
B	20 days	₹ 48,000	2%
C	30 days	₹ 75,000	3%
D	45 days	₹ 90,000	4%

The selling price per unit is ₹ 3. Average cost per unit is ₹ 2.25 and variable costs per unit are ₹ 2. The current bad debt loss is 1%. Required return on additional investment is 20%. Assume a 360 days year. Which of the above policies would you recommend for adoption?

**Solution:**

**A. Statement showing the Evaluation of Debtors Policies (Total Approach)**

Particulars		Present Policy 30 days	Proposed Policy A 40 days	Proposed Policy B 50 days	Proposed Policy C 60 days	Proposed Policy D 75 days
		(₹)	(₹)	(₹)	(₹)	(₹)
<b>A.</b>	<b>Expected Profit</b>					
	(a) Credit Sales	6,00,000	6,30,000	6,48,000	6,75,000	6,90,000
	(b) Total Cost other than Bad Debts					
	(i) Variable Costs [Sales × ₹ 2/ ₹ 3]	4,00,000	4,20,000	4,32,000	4,50,000	4,60,000
	(ii) Fixed Costs	50,000	50,000	50,000	50,000	50,000
		4,50,000	4,70,000	4,82,000	5,00,000	5,10,000
	(c) Bad Debts	6,000	9,450	12,960	20,250	27,600
	(d) Expected Profit [(a) - (b)-(c)]	1,44,000	1,50,550	1,53,040	1,54,750	1,52,400
<b>B.</b>	<b>Opportunity Cost of Investments in Receivables</b>					
		7,500	10,444	13,389	16,667	21,250
<b>C.</b>	<b>Net Benefits (A-B)</b>	1,36,500	1,40,106	1,39,651	1,38,083	1,31,150

**Recommendation:** The Proposed Policy A (i.e. increase in collection period by 10 days or total 40 days) should be adopted since the net benefits under this policy are higher as compared to other policies.

**Working Notes:**

(i) **Fixed Cost** = [Average Cost per unit - Variable Cost per unit] × No. of Units sold  
= [₹ 2.25 - ₹ 2.00] × (₹ 6,00,000/3)  
= ₹ 0.25 × 2,00,000 = ₹ 50,000

(ii) **Opportunity Cost of Average Investments**

$$= \text{Total Cost} \times \frac{\text{Collection period}}{360} \times \frac{\text{Rate of Return}}{100}$$

Present Policy =  $4,50,000 \times \frac{30}{360} \times \frac{20}{100} = 7,500$



$$\text{Policy A} = 4,70,000 \times \frac{40}{60} \times \frac{20}{100} = 10,444$$

$$\text{Policy B} = 4,82,000 \times \frac{50}{360} \times \frac{20}{100} = 13,389$$

$$\text{Policy C} = 5,00,000 \times \frac{60}{360} \times \frac{20}{100} = 16,667$$

$$\text{Policy D} = 5,10,000 \times \frac{75}{360} \times \frac{20}{100} = 21,250$$

**B.** Another method of solving the problem is **Incremental Approach**. Here we assume that sales are all credit sales.

Particulars	Present Policy	Proposed Policy A	Proposed Policy B	Proposed Policy C	Proposed Policy D
	30 day	40 days	50 days	60 days	75 days
	₹	₹	₹	₹	₹
<b>A. Incremental Expected Profit</b>					
(a) Incremental Credit Sales		30,000	48,000	75,000	90,000
(b) Incremental Costs					
(i) Variable Costs	4,00,000	20,000	32,000	50,000	60,000
(ii) Fixed Costs	50,000	-	-	-	-
(c) Incremental Bad Debt Losses	6,000	3,450	6,960	14,250	21,600
(d) Incremental Expected Profit (a - b - c)]		6,550	9,040	10,750	8,400
<b>B. Required Return on Incremental Investments</b>					
(a) Cost of Credit Sales	4,50,000	4,70,000	4,82,000	5,00,000	5,10,000
(b) Collection period	30	40	50	60	75
(a) Investment in Receivable (a × b/360)	37,500	52,222	66,944	83,333	1,06,250
(d) Incremental Investment in Receivables	-	14,722	29,444	45,833	68,750
(e) Required Rate of Return (in %)		20	20	20	20
(f) Required Return on Incremental Investments (d × e)		2,944	5,889	9,167	13,750
<b>C. Net Benefits (A - B)</b>	-	3,606	3,151	1,583	5,350

**Recommendation:** The Proposed Policy A should be adopted since the net benefits under this policy are higher than those under other policies.



C. Another method of solving the problem is by computing the Expected Rate of Return.

$$\text{Expected Rate of return} = \frac{\text{Incremental Expected Profit}}{\text{Incremental Investment in Receivables}} \times 100$$

$$\text{For Policy A} = \frac{\text{₹ } 6,550}{\text{₹ } 14,722} \times 100 = 44.49\%$$

$$\text{For Policy B} = \frac{\text{₹ } 9,040}{\text{₹ } 29,444} \times 100 = 30.70\%$$

$$\text{For Policy C} = \frac{\text{₹ } 10,750}{\text{₹ } 45,833} \times 100 = 23.45\%$$

$$\text{For Policy D} = \frac{\text{₹ } 8,400}{\text{₹ } 68,750} \times 100 = 12.22\%$$

**Recommendation:** The Proposed Policy A should be adopted since the Expected Rate of Return (44.49%) is more than the Required Rate of Return (20%) and is the highest among the given policies compared.

### Illustration 11

ABC Corporation is considering relaxing its present credit policy and is in the process of evaluating two proposed policies. Currently the firm has annual credit sales of ₹ 50 lakhs and accounts receivable turnover ratio of 4 times a year. The current level of loss due to bad debts is ₹1,50,000. The firm is required to give a return of 25% on the investment in new accounts receivables. The company's variable costs are 70% of the selling price. Given the following information, which is the better option?

(Amount in ₹)

	Present Policy	Policy Option I	Policy option II
Annual credit sales	50,00,000	60,00,000	67,50,000
Accounts receivable turnover ratio	4 times	3 times	2.4 times
Bad debt losses	1,50,000	3,00,000	4,50,000

**Solution:**

#### Statement showing the Evaluation of Debtors Policies

	Particulars	Present Policy	Proposed Policy I	Proposed Policy II
		₹	₹	₹
<b>A</b>	<b>Expected Profit</b>			
	(a) Credit Sales	50,00,000	60,00,000	67,50,000
	(b) Total Cost other than Bad Debts:			
	(i) Variable Costs	35,00,000	42,00,000	47,25,000
	(c) Bad Debts	1,50,000	3,00,000	4,50,000
	(d) Expected Profit [(a) - (b) - (c)]	13,50,000	15,00,000	15,75,000
<b>B</b>	<b>Opportunity Cost of Investments in Receivables</b>	2,18,750	3,50,000	4,92,188
<b>C</b>	<b>Net Benefits (A - B)</b>	11,31,250	11,50,000	10,82,812



**Recommendation:** The Proposed Policy I should be adopted since the net benefits under this policy is higher as compared to other policies.

**Workings:** Calculation of Opportunity Cost of Average Investments

Opportunity Cost	= Total Cost × $\frac{\text{Collection period}}{12} \times \frac{\text{Rate of Return}}{100}$
Present Policy	= ₹ 35,00,000 × 3/12 × 25% = ₹ 2,18,750
Proposed Policy I	= ₹ 42,00,000 × 4/12 × 25% = ₹ 3,50,000
Proposed Policy II	= ₹ 47,25,000 × 5/12 × 25% = ₹ 4,92,188

### Illustration 12

Gemini Products Ltd. is considering the revision of its credit policy with a view to increasing its sales and profits. Currently all its sales are on credit and the customers are given one month's time to settle the dues. It has a contribution of 40% on sales and it can raise additional funds at a cost of 20% per annum. The marketing director of the company has given the following options with draft estimates for consideration.

Particulars	Current position	Option I	Option II	Option III
Sales (₹ Lakhs)	200	210	220	250
Credit period (months)	1	1½	2	3
Bad debts (% of sales)	2	2½	3	5
Cost of credit administration (₹ Lakhs)	1.20	1.30	1.50	3.00

Advise the company to take the right decision. (Workings should form part of the answer).

### Solution:

Evaluation of the different options in credit policy of Gemini Products Ltd. (₹ in Lakhs)

Credit period (months)	Current 1.0	Option I (1.5)	Option II (2.0)	Option III (3.0)
Sales	200	210	220	250
Less: Variable cost (60%)	120	126	132	150
Contribution (a)	80.00	84.00	88.00	100.00
Less: Costs				
Cost of funds invested in debtors balance	3.33	5.25	7.33	12.50
Bad debts	4.00	5.25	6.60	12.50
Cost of credit administration	1.20	1.30	1.50	3.00
(b)	8.53	11.80	15.43	28.00
Net contribution (a) – (b)	71.47	72.20	72.57	72.00

### Analysis:

Since the net contribution is highest in option II, it is suggested to extend 2 months credit period to the customers.

**Illustration 13**

Surya Industries Ltd. is marketing all its products through a network of dealers. All sales are on credit and the dealers are given one month time to settle bills. The company is thinking of changing the credit period with a view to increase its overall profits. The marketing department has prepared the following estimates for different periods of credit:

Particulars	Present Policy	Plan I	Plan II	Plan III
Credit period (in months)	1	1.5	2	3
Sales (₹ Lakhs)	120	130	150	180
Fixed costs (₹ Lakhs)	30	30	35	40
Bad debts (% of sales)	0.5	0.8	1	2

The company has a contribution/sales ratio of 40% further it requires a pre-tax return on investment at 20%. Evaluate each of the above proposals and recommend the best credit period for the company.

**Solution:****Analysis of Credit Policies**

(₹ in Lakhs)

Credit Period (months)	Current Policy (1)	Plan I (1.5)	Plan II (2)	Plan III (3)
Credit sales	120	130	150	180
Less: Variable cost @ 60%	72	78	90	108
Contribution	48	52	60	72
Less: Fixed cost	30	30	35	40
Operating Profit (a)	18	22	25	32
Cost of Sales (Variable Cost + Fixed Cost)	102	108	125	148
Investment in debtors [Cost of sales x Credit period / 12 months]	8.5	13.5	20.83	37.00
Cost of Investment in debtors @ 20% (b)	1.70	2.70	4.17	7.40
Credit sales	120	130	150	180
Bad debts (% of sales)	0.5%	0.8%	1%	2%
Bad debts (c)	0.60	1.04	1.50	3.60
Net Profit (a) – [(b) + (c)]	15.70	18.26	19.33	21.00

**Analysis:**

The net profit is higher if 3 months credit period is allowed. Hence, it is suggested to adopt plan III.

**Illustration 14**

The following are the details regarding the operations of a firm during a period of 12 months.

Sales	₹ 12,00,000
Selling price per unit	₹ 10
Variable cost price per unit	₹ 7
Total cost per unit	₹ 9



Credit period allowed to customers one month. The firm is considering a proposal for a more liberal extension of credit which will result in increasing the average collection period from one month to two months. This relaxation is expected to increase the sales by 25% from its existing level.

You are required to advise the firm regarding adoption of the new credit policy, presuming that the firm's required return on investment is 25%.

**Solution:****Appraisal of Credit policy** (₹)

Particulars	Present	Proposed	Incremental
Credit period(ACP)	1 month	2 months	1 months
Sales (units)	1,20,000	1,50,000	30,000
Sales @ 10 (in ₹)	12,00,000	15,00,000	3,00,000
Total Cost	10,80,000	12,90,000	2,10,000
Profit	1,20,000	2,10,000	90,000
Investment in receivables	$10,80,000 / 12 = 90,000$	$12,90,000 / 6 = 2,15,000$	1,25,000

Required return on Incremental Investment (1,25,000@ 25%) = 31,250

Actual return on Investment = 90,000

(or)

$$(90,000 / 1,25,000) \times 100 = 72\%$$

Since the Incremental return is greater than required return on Incremental investment advised to adopt new credit policy.

**Illustration 15**

Trinadh Traders Ltd. currently sells on terms of next 30 days. All the sales are on credit basis and average collection period is 35 days. Currently, it sells 5,00,000 units at an average price of ₹ 50 per unit. The variable cost to sales ratio is 75% and a bad debt to sales ratio is 3%. In order to expand sales, the management of the company is considering changing the credit terms from net 30 to '2/10, net 30'. Due to the change in policy, sales are expected to go up by 10%, bad debt loss on additional sales will be 5% and bad debt loss on existing sales will remain unchanged at 3%. 40% of the customers are expected to avail the discount and pay on the tenth day. The average collection period for the new policy is expected to be 34 days. The company required a return of 20% on its investment in receivables.

You are required to find out the impact of the change in credit policy of the profit of the company. Ignore taxes.



**Solution:**

**Trinadh Traders**  
**Appraisal of Credit Policy**

(₹)

	Present	Proposed	Gain/Loss)
Credit terms	Net 30	(2 / 10)Net 30	
Avg. Collection Period	35 days	34 days	
Discount sales	-	40%	
Bad debts	3%	3 % + 5%	
Sales (units)	5,00,000	5,50,000	
Incremental Contribution [50,000 x 50 x 25%]			6,25,000
Incremental bad debts [50,000 x 50 x 5%]			(1,25,000)
Discount [5,50,000 x 40% x 50 x 2%]			(2,20,000)
Investment in Receivables	[5,00,000 x 50 x (35/360)] = 24,30,555	[5,00,000 x 50 x (37/365)] + [50,000 x 50 x 75% x 34/360] = 25,38,194	
Incremental investment		1,07,629	
Finance cost	(1,07,629 x 20%)		(21,528)
Incremental gain			2,58,472

By implementing new credit policy, the profit is increased by ₹2,58,472. So the new credit policy is advised to implement.

**Illustration 16**

A firm is considering pushing up its sales by extending credit facilities to the following categories of customers:

- Customers with a 10% risk of non-payment, and
- Customers with a 30% risk of non-payment.

The incremental sales expected in case of category (a) are ₹40,000 while in case of category (b) they are ₹50,000.

The cost of production and selling costs are 60% of sales while the collection costs amount to 5% of sales in case of category (a) and 10% of sales in case of category (b).

You are required to advise the firm about extending credit facilities to each of the above categories of customers.

**Solution:**

**Evaluation of Credit Policies**

Category a) 10% risk of non-payment

Particulars		(₹)
Incremental sales		40,000
Less: Bad debts @ 10%		4,000
Sales realized		36,000
Less: Cost of production and selling cost (40,000 x 60%)	24,000	
Less: Collection cost (40,000 x 5%)	2,000	26,000
Incremental profit		10,000



Category (b) 30% risk of non-payment

		(₹)
Incremental sales		50,000
Less: Bad debts @ 30% (50,000 x 30%)		15,000
Sales realized		35,000
Less: Cost of production and selling cost (50,000 x 60%)	30,000	
Less: Collection cost (50,000 x 10%)	5,000	35,000
Incremental profit		Nil

**Comment:** Advise to extend credit facility to category (a) customers alone.

### Illustration 17

The PKJ Company currently sells on terms 'net 45'. The company has sales of ₹37.50 Lakhs a year, with 80% being the credit sales. At present, the average collection period is 60 days. The company is now considering offering terms '2/10, net 45'. It is expected that the new credit terms will increase current credit sales by 1/3rd. The company also expects that 60% of the credit sales will be on discount and average collection period will be reduced to 30 days. The average selling price of the company is ₹100 per unit and variable cost is 85% of selling price. The Company is subject to a tax rate of 40%, and its before-tax rate of borrowing for working capital is 18%. Should the company change its credit terms to '2/10, net 45'? Support your answers by calculating the expected change in net profit. (Assume 360 days in a year)

### Solution:

Appraisal of new credit policy

	Present	Proposed	Incremental
Credit term	"net 45"	"2/10 net 45"	
Average collection period	60 days	30 days	
Discount sales	-	60%	
	(₹)	(₹)	(₹)
1. Credit sales (37,50,000 x 80%)	30,00,000	40,00,000	
2. Variable Cost 85%	25,50,000	34,00,000	
3. Contribution (1-2)	4,50,000	6,00,000	1,50,000
4. Discount (40,00,000 x 60% x 2%)		48,000	(48,000)
5. Investment in debtors			
$30,00,000 \times \frac{60}{360}$	5,00,000		
$30,00,000 \times \frac{30}{360} + 10,00,000 \times 85\% \times \frac{30}{360}$		3,20,833	
6. Savings in investment	-	1,79,167	
7. Finance cost saved (1,79,167 x 10.8%)*			19,350
8. Surplus (3-4+7)			1,21,350

**Decision:** Advised to implement the proposed policy, as there is a surplus of ₹ 1,21,350 \* Cost of capital = Rate of interest x (1-tax rate) = 18% x (1-0.4) = 10.8%

**Illustration 18**

Slow Players are regular customers of Goods Dealers Ltd., Calcutta and have approached the sellers for extension of credit facility for enabling them to purchase goods from Goods Dealers Ltd. On the analysis of past performance and on the basis of information supplied, the following pattern of payment schedule emerges in regard to Slow Players:

Schedule	Pattern
At the end of 30 days	15% of the bill
60 days	34% of the bill
90 days	30% of the bill
100 days	20% of the bill
Non recovery	1% of the bill

Slow Players wants to enter into a firm commitment for purchase of goods of ₹ 15,00,000 in 2012, deliveries to be made in equal quantities on the first day of each quarter in the calendar year. The price per unit of the commodity is ₹ 150 on which a profit of ₹ 5 per unit is expected to be made. It is anticipated by the Good Dealers Ltd., that taking up of this contract would mean an extra recurring expenditure of ₹ 5,000 per annum. If the opportunity cost of funds in the hands of Goods Dealers is 24% per annum, would you as the Finance Manager of the seller recommend the grant of credit to Slow Players? Working should form part of your answer.

**Solution:**

Appraisal of credit proposal from Slow Players:

(a) Incremental profit =  $15,00,000 \times \frac{5}{150} = ₹ 50,000$

(b) Calculation of incremental finance cost:  $17,975^* \times 4 = ₹ 71,900$

\*Sales per quarter =  $\frac{15,00,000}{4} = ₹ 3,75,000$

Finance cost per quarter:

₹

For 15% of bill	$3,75,000 \times 15\% \times 24\% \times \frac{30}{360}$	1,125
For 34% of bill	$3,75,000 \times 34\% \times 24\% \times \frac{60}{360}$	5,100
For 30% of bill	$3,75,000 \times 30\% \times 24\% \times \frac{90}{360}$	6,750
For 20% of bill	$3,75,000 \times 20\% \times 24\% \times \frac{100}{360}$	5,000
Finance cost per quarter		17,975

(c) Extra recurring expenses = ₹ 5,000

(d) Bad debts =  $15,00,000 \times 1\% = ₹ 15,000$

Therefore, incremental profit =  $a - b - c - d = 50,000 - 71,900 - 5,000 - 15,000 = ₹ 41,900$  (loss)

**Comment:** As there is incremental loss, it is advice not to extend credit facility to slow players.



### Monitoring and Control of Receivables

Monitoring and Control of Receivables can be exercised in the following manner:

- (a) *Computation of average age of receivables:* It involves computation of average collection period.
- (b) *Ageing Schedule:* When receivables are analysed according to their age, the process is known as preparing the ageing schedules of receivables. The computation of average age of receivables is a quick and effective method of comparing the liquidity of receivables with the liquidity of receivables in the past and also comparing liquidity of one firm with the liquidity of the other competitive firm. The purpose of classifying receivables by age groups is to have a closer control over the quality of individual accounts. To ascertain the condition of receivables for control purposes, it may be considered desirable to compare the current ageing schedule with an earlier ageing schedule in the same firm and also to compare this information with the experience of other firms.
- (c) *Collection Programme:*
  - (i) Monitoring the state of receivables
  - (ii) Intimation to customers when due date approaches
  - (iii) Telegraphic and telephonic advice to customers on the due date
  - (iv) Threat of legal action on overdue Accounts
  - (v) Legal action on overdue Accounts

## 8.6 CASH MANAGEMENT

The term "Cash" with reference to management of cash is used in two ways. In a narrow sense cash refers to coins, currency, cheques, drafts and deposits in banks. The broader view of cash includes near cash assets such as marketable securities and time deposits in banks. The reason why these near cash assets are included in cash is that they can readily be converted into cash. Usually, excess cash is invested in marketable securities as it contributes to profitability.

Cash is one of the most important components of current assets. Every firm should have adequate cash, neither more nor less. Inadequate cash will lead to production interruptions, while excessive cash remains idle and will impair profitability. Hence, there is a need for cash management. The cash management assumes significance for the following reasons:-

### Significance

- (i) **Cash planning:** Cash is the most important as well as the least unproductive of all current assets. Though, it is necessary to meet the firm's obligations, yet idle cash earns nothing. Therefore, it is essential to have a sound cash planning neither excess nor inadequate.
- (ii) **Management of cash flows:** This is another important aspect of cash management. Synchronisation between cash inflows and cash outflows rarely happens. Sometimes, the cash inflows will be more than outflows because of receipts from debtors, and cash sales in huge amounts. At other times, cash outflows exceed inflows due to payment of taxes, interest and dividends etc. Hence, the cash flows should be managed for better cash management.
- (iii) **Maintaining optimum cash balance:** Every firm should maintain optimum cash balance. The management should also consider the factors determining and influencing the cash balances at various point of time. The cost of excess cash and danger of inadequate cash should be matched to determine the optimum level of cash balances.



- (iv) **Investment of excess cash:** The firm has to invest the excess or idle funds in short term securities or investments to earn profits as idle funds earn nothing. This is one of the important aspects of management of cash.

Thus, the aim of cash management is to maintain adequate cash balances at one hand and to use excess cash in some profitable way on the other hand.

### Motives

Motives or desires for holding cash refers to various purposes. The purpose may be different from person to person and situation to situation. There are four important motives to hold cash.

- (i) To carry out the regular business transactions.
- (ii) As a precautionary measure to meet the business exigencies.
- (iii) In order to exploit the profitable opportunities under speculative conditions.
- (iv) To compensate banks and other financial institutes for providing certain services and loans.

### Objectives

The basic objectives of cash management are

- (i) to make the payments when they become due and
- (ii) to minimize the cash balances.

The task before the cash management is to reconcile the two conflicting nature of objectives.

### Factors determining cash needs

Maintenance of optimum level of cash is the main problem of cash management. The level of cash holding differs from industry to industry, organisation to organisation. The factors determining the cash needs of the industry is explained as follows:

- (i) **Matching of cash flows:** The first and very important factor determining the level of cash requirement is matching cash inflows with cash outflows. If the receipts and payments are perfectly coincide or balance each other, there would be no need for cash balances. The need for cash management therefore, due to the non-synchronisation of cash receipts and disbursements.
- (ii) **Short costs:** Short costs are defined as the expenses incurred as a result of shortfall of cash. The short costs includes, transaction costs associated with raising cash to overcome the shortage, borrowing costs associated with borrowing to cover the shortage i.e. interest on loan, loss of trade-discount, penalty rates by banks to meet a shortfall in cash balances and costs associated with deterioration of the firm's credit rating etc. which is reflected in higher bank charges on loans, decline in sales and profits.
- (iii) **Cost of excess cash balances:** One of the important factors determining the cash needs is the cost of maintaining cash balances i.e. excess or idle cash balances. The cost of maintaining excess cash balance is called excess cash balance cost.
- (iv) **Uncertainty in business:** The first requirement of cash management is a precautionary cushion to cope with irregularities in cash flows, unexpected delays in collections and disbursements and defaults. The uncertainty can be overcome through accurate forecasting of tax payments, dividends, capital expenditure etc. and ability of the firm to borrow funds through over draft facility.
- (v) **Cost of procurement and management of cash:** The costs associated with establishing and operating cash management staff and activities determining the cash needs of a business firm. These costs are generally fixed and are accounted for by salary, storage and handling of securities etc. The above factors are considered to determine the cash needs of a business firm.



The strategies for cash management are discussed in detail in the following lines:

(I) **Projection of cash flows and planning:** The cash planning and the projection of cash flows is determined with the help of Cash Budget. The Cash Budget is the most important tool in cash management. It is a device to help a firm to plan and control the use of cash. It is a statement showing the estimated cash inflows and cash outflows over the firm's planning horizon. In other words the net cash position i.e., surplus or deficiency of a firm is highlighted by the cash budget from one budgeting period to another period.

(II) **Determining optimal level of cash holding by the company**

The optimal level of cash holding by a company can be determined with the help of the following models:

- (a) Inventory model (Economic Order Quantity) to cash management
- (b) Stochastic model
- (c) Probability model

**[(a) Inventory model (EOQ) to cash management (Baumol model)]:** Economic Order Quantity (EOQ) model is used in determination of optimal level of cash of a company. According to this model optimal level of cash balance is one at which cost of carrying the inventory of cash and cost of going to the market for satisfying cash requirements is minimum. The carrying cost of holding cash refers to the interest foregone on marketable securities where as cost of giving to the market means cost of liquidating marketable securities in cash.

Optimum level of cash balance can be determined as follows:

$$Q = \sqrt{\frac{2AO}{C}}$$

Where Q = Optimum level of cash

A= Total amount of transaction demand

O= Average fixed cost of securing cash from the market (transaction cost)

C= Cost of carrying cash, i.e., interest rate on marketable securities for the period involved.

**Assumptions:** The model is based on the following assumptions:

- (i) The demand for cash, transactions costs of obtaining cash and the holding costs for a particular period are given and do not change during that period.
- (ii) There is a constant demand for cash during the period under consideration.
- (iii) Cash payments are predictable
- (iv) Banks do not impose any restrictions on firms with respect of maintenance of minimum cash balances in the bank accounts.

**(b) Stochastic (Miller-Orr) Model:** The model prescribes two control limits, Upper control Limit (UCL) and Lower Control Limit (LCL). when the cash balances reaches the upper limit a transfer of cash to investment account should be made and when cash balances reach the lower point a portion of securities constituting investment account of the company should be liquidated to return the cash balances to its return point. The control limits are converting securities into cash and the vice - versa, and the cost carrying stock of cash.

The "O" optimal point of cash balance is determined by using the formula

$$O = 3\sqrt{\frac{2TV}{4I}}$$

Where,

O = Target cash balance (Optimal cash balance)

T = Fixed cost associated with security transactions

I = Interest per day on marketable securities

V = Variance of daily net cash flows.

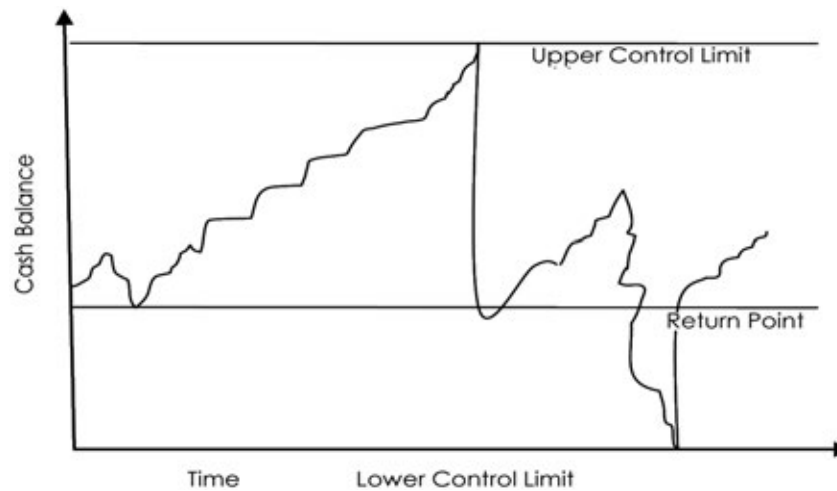

**Limitations:** This model is subjected to some practical problems

- (i) The first and important problem is in respect of collection of accurate data about transfer costs, holding costs, number of transfers and expected average cash balance.
- (ii) The cost of time devoted by financial managers in dealing with the transfers of cash to securities and vice versa.
- (iii) The model does not take into account the short term borrowings as an alternative to selling of marketable securities when cash balance reaches lower limit.

Besides the practical difficulties in the application of the model, the model helps in providing more, better and quicker information for management of cash. It was observed that the model produced considerable cost savings in the real life situations.

### (c) Probability Model

According to this model, a Finance Manager has to estimate probabilistic out comes for net cash flows on the basis of his prior knowledge and experience. He has to determine what is the operating cash balance for a given period, what is the expected net cash flow at the end of the period and what is the probability of occurrence of this expected closing net cash flows.

The optimum cash balance at the beginning of the planning period is determined with the help of the probability distribution of net cash flows. Cost of cash shortages, opportunity cost of holding cash balances and the transaction cost.

#### Assumptions:

- (i) Cash is invested in marketable securities at the end of the planning period say a week or a month.
- (ii) Cash inflows take place continuously throughout the planning period.
- (iii) Cash inflows are of different sizes.
- (iv) Cash inflows are not fully controllable by the management of firm.



- (v) Sale of marketable securities and other short term investments will be effected at the end of the planning period.

The probability model prescribed the decision rule for the Finance Manager that he should go on investing in marketable securities from the opening cash balance until the expectation, that the ending cash balance will be below the optimum cash balance, where the ratio of the incremental net return per rupee of investment is equal to the incremental shortage cost per rupee.

**(III) Strategy for economizing cash:** Once cash flow projections are made and appropriate cash balances are established, the finance manager should take steps towards effective utilization of available cash resources. A number of strategies have to be developed for this purpose. They are:

- (a) Strategy towards accelerating cash inflows and
- (b) Strategy towards decelerating cash outflows
- (a) **Strategy towards accelerating cash inflows:** In order to accelerate the cash inflows and maximize the available cash the firm has to employ several methods such as reduce the time lag between the moment a payment to the company is mailed and the moment the funds are ready for redeployment by the company. This includes the quick deposit of customer's cheques, establishing collection centers and lock – box system etc.
- (b) **Strategy for slowing cash outflows:** In order to accelerate cash availability in the company, Finance Manager must employ some devices that could slow down the speed of payments outward in addition to accelerating collections. The methods of slowing down disbursements are as follows:
- Delaying outward payment;
  - Making pay roll periods less frequent;
  - Solving disbursement by use of drafts;
  - Playing the float;
  - Centralised payment system;
  - By transferring funds from one bank to another bank firm can maximize its cash turnover.

### Illustration 19

United Industries Ltd. projects that cash outlays of ₹ 37,50,000 will occur uniformly throughout the coming year. United plans to meet its cash requirements by periodically selling marketable securities from its portfolio. The firm's marketable securities are invested to earn 12% and the cost per transaction of converting securities to cash is ₹ 40.

- Use the Baumol Model to determine the optimal transaction size of marketable securities to cash.
- What will be the company's average cash balance?
- How many transfers per year will be required?
- What will be the total annual cost of maintaining cash balances?

### Solution:

- (a) Optimal size =  $\sqrt{2TA/I} = \sqrt{(2 \times 40 \times 37,50,000) / 0.12} = 50,000$
- (b) Average cash balance = ₹ 25,000
- (c) No of transactions per year =  $37,50,000 / 50,000 = 75$
- (d) Total annual cost





(e) Transaction cost	$75 \times 40$	= 3,000
(f) Opportunity cost	$50,000 \times 1/2 \times 12\%$	= <u>3,000</u>
		<u>6,000</u>

### Illustration 20

The Cyberglobe Company has experienced a stochastic demand for its product. With the result that cash balances fluctuate randomly. The standard deviation of daily net cash flows is ₹1,000. The company wants to impose upper and lower bound control limits for conversion of cash into marketable securities and vice-versa. The current interest rate on marketable securities is 6%. The fixed cost associated with each transfer is ₹1,000 and minimum cash balance to be maintained is ₹10,000.

Compute the upper and lower limits.

#### Solution:

Standard Deviation = 1,000

Variance =  $1,000 \times 1,000 = 10,00,000$

Interest =  $6\% / 365 = 0.016\%$

T = 1,000

L = 10,000

$$Z = 3\sqrt{(3TV / 4I)}$$

$$= 3\sqrt{(3 \times 1,000 \times 1,000 \times 1,000) / (4 \times 0.016\%)}$$

$$= 3,573$$

Return point = Z + L

→  $3573 + 10000 = 13573$

Upper limit =  $3R - 2L$

→  $40719 - 20000 = 20719$

## GLOSSARY

**Commercial paper:** Commercial paper is an unsecured, short-term promissory note issued by highly reputed and credit rated companies, mostly on a discount basis.

**Credit Standards:** Credit standards represent the basic criteria for extension of credit to customers. The levels of sales and receivables are likely to be high if the credit standards are relatively loose, as compared to a situation when they are relatively tight.

**Credit terms:** Credit terms refer to the terms under which a firm sells goods on credit to its customers. Two components of the credit terms are (a) Credit Period and (b) Cash Discount.

**Factoring:** Factoring is a system of selling receivables to a financial institution or a factor usually on a 'non-recourse' basis.

**Gross Working Capital:** Gross Working Capital refers to the total of the current assets.

**Inventory:** The term inventory refers to the stocks of the product a firm is offering for sale and the components that make up the product. This includes raw materials, work-in-process and finished goods.



**Letter of Credit:** Letter of Credit is a formal document issued by a bank on behalf of customer, mentioning the conditions under which the bank will honour the commitments of the customer.

**Net Working Capital:** Net Working Capital refers to the excess of the current assets over current liabilities.

**Trade Credit:** Trade Credit is the credit given by one business firm to the other arising from credit sales. It is recorded as an accounts receivable (debtor) by the selling firm and as an accounts payable (creditor) by the buying firm.

**Working Capital:** Working Capital means the funds available for day-to-day operations of an enterprise. It also represents excess of current assets over current liabilities including short-term loans.

### Self Learning Questions:

1. Explain Working Capital and its kinds.
2. What are the determinants of Working Capital?
3. What are the consequences of excessive and inadequate Working Capital?
4. What are the various sources of Working Capital?
5. What are the costs associated with maintaining receivables?
6. Write short note on:
  - (a) Tandon Committee norms
  - (b) Hard Core Working Capital
  - (c) Economic Ordering Quantity
  - (d) Inventory Turnover Ratio
  - (e) Working Capital Cycle (or) Operating Cycle
  - (f) Strategy for accelerating cash inflow.
  - (g) Credit evaluation of customer.
7. A company is currently facing working capital crunch. You are required to discuss the various areas that you would like to look into and suggest the ways by which the company can overcome the problem.
8. List out the importance of Cash Management.
9. What are the various tools and technique of Inventory Control?
10. What are the various types of Working Capital?
11. Write a short note on Factoring.
12. State the benefits accrue out of management of Receivables.
13. Discuss the various determinants of credit policy.



14. What are the various factors that determine the cash need of business?
15. What are the strategies a company can adopt for the optimum utilisation of cash management?
16. Explainin Baumol's Model of Cash Management.
17. Discuss Miller-Orr Cash Management model.

**Multiple Choice Questions:**

1. Working Capital is defined as
  - (a) Excess of Fixed Assets over long-term liabilities
  - (b) Excess of current assets over current liabilities
  - (c) Excess of current liabilities over current assets
  - (d) None of the above.
2. Working Capital is also known as "Circulating Capital, fluctuating capital and revolving capital". The aforesaid statement is;
  - (a) Incorrect
  - (b) Correct
  - (c) Cannot say
3. The basic objectives of Working Capital Management are:
  - (a) Optimum utilization of resources for profitability
  - (b) Ensuring marginal return on current assets is always more than cost of capital
  - (c) To meet day-to-day current obligations
  - (d) Select any one of the above statement
4. The term net working capital refers to the difference between the current assets minus current liabilities.
  - (a) The statement is incorrect
  - (b) The statement is correct
  - (c) Cannot say
5. A Conservative Working Capital strategy calls for high levels of current assets in relation to sales.
  - (a) Not agreed
  - (b) Agreed
  - (c) Cannot say



6. Trade credit is a
  - (a) Negotiated source of finance
  - (b) Spontaneous source of finance
  - (c) Hybrid source of finance
  - (d) None of the above
  
7. Factoring is a method of financing whereby a firm sells its trade debts at a discount to a financial institution. The statement is:
  - (a) Incorrect
  - (b) Correct
  - (c) Partially correct
  - (d) Cannot say
  
8. A factoring arrangement can be both with recourse as well as without recourse:
  - (a) False
  - (b) True
  - (c) Partially correct
  - (d) Cannot say
  
9. The Bank financing of working capital will generally be in the following form; cash credit, overdraft, bills discounting, bills acceptance, line of credit; letter of credit and bank guarantee.
  - (a) Do not agree
  - (b) Agreed
  - (c) Cannot say
  
10. The credit terms may be expressed as "3/15 net 60". It means that a 3% discount will be granted if the customer pays within 15 days, if he does not avail the offer he must make payment within 60 days.
  - (a) Do not agree with the statement
  - (b) Agreed with the statement
  - (c) Do not agree with the statement
  - (d) Cannot say
  
11. The term 'net 50' implies that the customer will make payment.
  - (a) Exactly on 50th day
  - (b) Not later than 50th day
  - (c) Before 50th day
  - (d) None of the above.



12. Trade credit is a source of:
  - (a) Long-term finance
  - (b) Spontaneous source of finance
  - (c) Medium term finance
  - (d) None of the above.
  
13. William J Baumol's model of Cash Management determines optimum cash level where the carrying cost and transaction cost are:
  - (a) Maximum
  - (b) Medium
  - (c) Minimum
  - (d) None of the above.
  
14. In Miller - ORR Model of Cash Management:
  - (a) The lower, upper limit, and return point of Cash Balances are set out
  - (b) Only lower limit and return point are decided
  - (c) Only upper limit and return point are decided
  - (d) None of the above are decided.
  
15. The term "Core current assets' was coined by
  - (a) Chore Committee
  - (b) Jilani Committee
  - (c) Tandon Committee
  - (d) None of the above.
  
16. The concept of operating cycle refers to the average time which elapses between the acquisition of raw materials and the final cash realisation. This statement is:
  - (a) Incorrect
  - (b) Correct
  - (c) Partially True
  - (d) Cannot say
  
17. When the items of inventory are classified according to value of usage, the technique is known as:
  - (a) XYZ Analysis
  - (b) DEF Analysis
  - (c) ABC Analysis
  - (d) None of the above.

[Ans: b, b, c, b, b, b, b, b, b, b, b, b, c, a, c, b, c]

**PRACTICAL PROBLEMS**

1. The board of Directors of Nanak Engineering Company Private Ltd. request you to prepare a statement showing the Working Capital requirements forecast for a level of activity of 1,56,000 units of production.

The following information is available for your calculation:

a.

	Per unit
Raw materials	₹ 90
Direct labour	40
Overheads	75
	205
Profits	60
Selling price per unit	265

b.

- (i) Raw materials are in stock on average one month.
- (ii) Materials are in process, on average 2 weeks.
- (iii) Finished goods are in stock, on average 1 month.
- (iv) Credit allowed by supplier one month.
- (v) Time lag in payment from debtors two months.
- (vi) Lag in payment of wages 1½ week.
- (vii) Lag in payment of overheads is one month.

20% of the output is sold against cash. Cash in hand and at bank is expected to be ₹ 60,000. It is to be assumed that production is carried on evenly throughout the year, wages and overheads accrue similarly and a time period of 4 weeks is equivalent to a month.

**Hint:** Current Assets ₹ 84,21,000, Current liabilities ₹ 21,60,000

2. On 1st April, 2015 the Board of Directors of Calci Limited wishes to know the amount of Working Capital that will required to meet the programme of activity they have planned for the year. The following information is available.
- (i) Issued and paid-up capital ₹ 2,00,000
  - (ii) Fixed assets valued at ₹ 1,25,000 on 31-12-2010
  - (iii) 5% Debentures ₹ 50,000
  - (iv) Production during the previous year was 60,000 units; it is planned that this level of activity should be maintained during the present year.
  - (v) The expected ratios of cost to selling price are – raw materials 60%, direct wages 10%, and overheads 20%.
  - (vi) Raw materials are expected to remain in stores for an average of two months before these are issued for production.



- (vii) Each unit of production is expected to be in process for one month.
- (viii) Finished goods will stay in warehouse for approximately three months.
- (ix) Creditors allow credit for 2 months from the date of delivery of raw materials.
- (x) Credit allowed to debtors is 3 months from the date of dispatch.
- (xi) Selling price per unit is ₹ 5.
- (xii) There is a regular production and sales cycle.

You are required to prepare:

- (a) Working Capital requirement forecast; and
- (b) An estimated Profit and Loss Account and Balance Sheet at the end of the year.

**Hint:** Current Assets ₹ 1,83,750, Current liabilities ₹ 30,000, Work in process ₹ 18,750, Balance Sheet Total ₹ 3,16,250, Debtors ₹ 75,000, Investment in Debtors ₹ 67,500

3. Q Ltd sells goods at a uniform rate of gross profit of 20% on sales including depreciation as part of cost of production. Its annual figures are as under:

	(₹)
Sales (at 2 months credit)	24,00,000
Materials consumed (suppliers credit 2 months)	6,00,000
Wages paid (Monthly at the beginning of the subsequent month)	4,80,000
Manufacturing expenses (cash expenses are paid – one month in arrear)	6,00,000
Administration expenses (cash expenses are paid – one month in arrear)	1,50,000
Sales promotion expenses (paid quarterly in advance)	75,000

The company keeps one month stock each of raw materials and finished goods. A minimum cash balance of ₹ 80,000 is always kept. The company wants to adopt a 10% safety margin in the maintenance of Working Capital.

The company has no work-in-progress

Find out the requirements of Working Capital of the company on cash cost basis.

**Hint:** Current Assets ₹ 6,06,250, Current liabilities ₹ 2,02,500

4. X Ltd. sells goods at a gross profit of 20%. It includes depreciation as part of cost of production. The following figures for the 12 months ending 31st Dec, 2011 are given to enable you to ascertain the requirement of working capital of the company on a cash cost basis.

In your working, you are required to assume that:

- (i) a safety margin of 15% will be maintained;
- (ii) Cash is to be held to the extent of 50% of current liabilities;
- (iii) There will be no work-in-progress;
- (iv) Tax is to be ignored.



Stocks of raw materials and finished goods are kept at one month's requirements. All working notes are to form part of your answer.

Sales at 2 months credit	₹ 27,00,000
Materials consumed (suppliers credit is for 2 months)	6,75,000
Total wages (paid at the beginning of the next month)	5,40,000
Manufacturing expenses outstanding at the end of the year (These expenses are paid one month in arrears)	60,000
Total administrative expenses (paid as above)	1,80,000
Sales promotion expenses paid quarterly and in advance	90,000

**Hint:** Current Assets ₹ 7,23,250, Current liabilities ₹ 2,32,500

5. Shree Cement Company Ltd, has an installed capacity of producing 1.25 lakh tonnes of cement per annum; its present capacity utilization is 80 percent, The major raw material to manufacture cement is limestone which is obtained from the company's own mechanized mine-located near the plant. The company produces cement in 200 kgs bags. From the information given below, determine the net working capital (NWC) requirement of the company for the current year.

**Cost structure per bag of cement (estimated)**

	(₹)
Gypsum	25
Limestone	15
Coal	30
Packing material	10
Direct labour	50
Factory overheads (including depreciation of ₹ 10)	30
Administrative overheads	20
Selling overheads Total cost	25
	205
Profit margin Selling price	45
	250
Add sale tax (10 percent of selling price) Invoice price to consumers'	25
	275

**Additional information**

- (i) Desired holding period of raw materials:  
Gypsum, 3 months  
Limestone, 1 month  
Coal, 2.5 months  
Packing material, 1.5 months
- (ii) The product is in process for a period of ½ month (assume full units of materials, namely gypsum, limestone and coal are required in the beginning; other conversion costs are to be taken at 50 percent.





- (iii) Finished goods are in stock for a period of 1 month before they are sold.
- (iv) Debtors are extended credit for a period of 3 months.
- (v) Average time lag in payment of wages is approximately  $\frac{1}{2}$  month and of overheads, 1 month.
- (vi) Average time lag in payment of sales tax is 1.5 months.
- (vii) The credit period extended by various suppliers are:
1. Gypsum, 2 months
  2. Coal, 1 month.
  3. Packing materials  $\frac{1}{2}$  month
- (viii) Minimum desired cash balance is ₹ 25 lakh. You may state your assumptions, if any.

[Hint: Total Current Assets ₹ 4,69,79,166; current liabilities ₹ 88,54,166; \* WIP ₹ 23,95,833]

6. XYZ Corporation is considering relaxing its present credit policy and is in the process of evaluating two proposed policies. Currently, the firm has annual credit sales of ₹50 lakhs and accounts receivable turnover ratio of 4 times a year. The current level of loss due to bad debts is ₹1,50,000. The firm is required to give a return of 25% on the investment in new accounts receivable. The company's variable costs are 70% of the selling price. Given the following information, which is the better option?

	Present Policy	Policy Option I	Option II
Annual credit sales Accounts receivable	₹ 50,00,000	60,00,000	67,50,000
Turnover ratio	4 times	3 times	2.4 times
Bad debts losses	1,50,000	3,00,000	4,50,000

**Hint:** Investment in debtors under present policy I ₹8,75,000, under proposed policy I ₹14,00,000, and policy II ₹19,68,750

7. A trader whose current sales are in the region of ₹8,00,000 per annum and an average collection period of 30 days wants to pursue a more liberal policy to improve sales. A study made by a management consultant reveals the following information

Credit policy	Increase in collection period	Increase in Sales	Present default anticipated
A	10 days	₹30,000	1.5%
B	20 days	₹ 48,000	2%
C	30 days	₹ 75,000	3%
D	40 days	₹ 90,000	4%

The selling price per unit is ₹3. Average cost per unit is ₹ 2.25 and variable costs per unit are ₹ 2. The current bad debt loss is 1%. Required return on additional investment is 20%. Assume a 360 days year.

Which of the above policies would you recommend for adoption?

**Hint:** policy A is recommended.



8. XYZ Ltd. has annual credit sales amounting to ₹10,00,000 for which it grants a credit of 60 days. However, at present no discount facility is offered by the firm to its customers. The company is considering a plan to offer a discount of "3/15 net 60". The offer of discount is expected to bring the total credit periods from 60 days to 45 days and 50% of the customers (in value) are likely to avail the discount facility. The selling price of the produces is ₹ 15 while the average cost per unit comes to ₹12.

Please advise the company whether to resort to discount facility if the rate of return is 20% and a month is equal to 30 days.

**Hint:** New policy not recommended

9. Deluge Cosmetics Company Limited is considering changing its credit policy from net 60 to 2/10 net 45. Its current sales are ₹8,00,000 and variable cost to sales ratio is 0.6. Administrative and collection costs are ₹60,000 and ₹40,000 respectively. Their present bad debt to sales ratio is 0.01. With the change in credit terms it expects an increase in sales and operating costs by ₹4000.00 and ₹20,000 respectively. The new bad debts to sales ratio would be 0.03. Assume 40% of the customers avail the discount and the remaining pay by 60 days amounting to an average collection period of 40 days. Also assume the cost of financing receivables is 14%.

You are required to advise the company regarding the change in credit terms.

**Hint:** New policy is recommended

10. Mr. Barin Basu, the finance director of Swan Bearing Co. is evaluating the present credit policy of his company. Under the present policy, the company is offering 3% discount for payment within 10 days. The analysis of accounts receivable shows an average collection period of 30 days. Mr. Basu is of the opinion that the discount should be discontinued as it is affecting the profitability of the company in the present scenario of rising manufacturing costs. It is estimated that if the discount is discontinued the average collection period would increase to 35 days. Presently 30% of the total customers are availing discount and if the discount is withdrawn; these customers can also be expected to pay along with the other customers. The marketing manager informed him that as a result, sales might drop from the present level of 2,10,000 units to 2,00,000 units under the proposed policy. Selling price per unit is ₹45. The average cost per unit is ₹40 and variable cost of sales ratio is 75%. The required rate of return on the company's investments is 20%.

You are required to evaluate whether he should withdraw the discount or not.

**Hint:** New policy not recommended.



## Study Note - 9

### COST OF CAPITAL, CAPITAL STRUCTURE THEORIES, DIVIDEND DECISIONS AND LEVERAGE ANALYSIS



This Study Note includes:

- 9.1 Meaning of Cost of Capital – Computation of Cost of Capital
- 9.2 Capital Structure Theories
- 9.3 Dividend Policy
- 9.4 Leverage Analysis
- 9.5 EBIT-EPS Indifference Point/Level

#### 9.1 MEANING OF COST OF CAPITAL - COMPUTATION OF COST OF CAPITAL

##### INTRODUCTION

The Cost of Capital is the most important and controversial area in Financial Management. Capital Budgeting decisions have a major impact on the firm, and Cost of Capital is used as a criterion to evaluate the capital Budgeting decisions i.e., whether to accept or reject a project. Knowledge about cost of capital, and how it is influenced by financial leverage, is useful in making capital structure decisions. The cost of capital is the most important concept in financial decision making. The chief objective of measuring the cost of capital is its use as a decision criterion in capital budgeting.

**Definition:** Cost of Capital is the minimum rate of return that must be earned on investments, in order to meet the rate of return required by the investors. It is the discount rate applied to evaluate the firm's capital projects. According to Professor I.M.Pandy "Cost of Capital is the discount rate used in evaluating the desirability of the investment project". The cost of capital is the minimum rate of return required for investment project. The cost of capital is the minimum rate of return which will maintain the market value per share at its current level. If the firm earns more than the cost of capital, the market value per share is expected to increase. In other words, it is the rate that suppliers of funds expect to get. It is determined by the cost of the various sources of finance. It is also referred to as the weighted average cost of capital or composite/combined cost of capital.

**James C. Van Horne:** The cost of Capital is "a cut-off rate for the allocation of capital to investments of projects. It is the rate of return on a project that will leave unchanged the market price of the stock".

**Soloman Ezra:** "Cost of Capital is the minimum required rate of earnings or the cut-off rate of capital expenditure".

It is clear from the above definitions that the cost of capital is that minimum rate of return which a firm is expected to earn on its investments so that the market value of its share is maintained. We can also conclude from the above definitions that there are three basic aspects of the concept of cost of capital:

- (i) Not a cost as such: In fact the cost of capital is not a cost as such, it is the rate of return that a firm requires to earn from its projects.



(ii) It is the minimum rate of return: A firm's cost of capital is that minimum rate of return which will at least maintain the market value of the share.

(iii) It comprises three components:

$$K = r_o + b + f$$

Where, k = Cost of Capital;

$r_o$  = Return at zero risk level:

b = Premium for business risk, which refers to the variability in operating profit (EBIT) due to change in sales.

f = Premium for financial risk which is related to the pattern of capital structure.

### Importance of Cost of Capital

The Cost of Capital is very important in Financial Management and plays a crucial role in the following areas:

(i) **Capital budgeting decisions:** The cost of capital is used for discounting cash flows under Net Present Value method for investment proposals. So, it is very useful in capital budgeting decisions.

(ii) **Capital structure decisions:** An optimal capital is that structure at which the value of the firm is maximum and cost of capital is the lowest. So, cost of capital is crucial in designing optimal capital structure.

(iii) **Evaluation of final Performance:** Cost of capital is used to evaluate the financial performance of top management. The actual profitability is compared with the actual cost of capital of funds and if profit is greater than the cost of capital the performance may be said to be satisfactory.

(iv) **Other financial decisions:** Cost of capital is also useful in making such other financial decisions as dividend policy, capitalization of profits, making the rights issue, etc.

### Classification of Cost of Capital

**Cost of Capital can be classified as follows:**

(i) **Historical Cost and Future Cost:** Historical costs are book costs relating to the past, while future costs are estimated costs act as guide for estimation of future costs.

(ii) **Specific Costs and Composite Costs:** Specific cost is the cost of a specific source of capital, while composite cost is combined cost of various sources of capital. Composite cost, also known as the weighted average cost of capital, should be considered in capital and capital budgeting decisions.

(iii) **Explicit and Implicit Cost:** Explicit cost of any source of finance is the discount rate which equates the present value of cash inflows with the present value of cash outflows. It is the internal rate of return and is calculated with the following formula;

$$I_o = \frac{C_1}{(1+K)^1} + \frac{C_2}{(1+K)^2} + \dots + \frac{C_n}{(1+K)^n}$$

$I_o$  = Net cash inflow received at zero of time

C = Cash outflows in the period concerned



K = Explicit cost of capital

N = Duration of time period

Implicit cost also known as the opportunity cost is the opportunity foregone in order to take up a particular project. For example, the implicit cost of retained earnings is the rate of return available to shareholders by investing the funds elsewhere.

- (iv) **Average Cost and Marginal Cost:** An average cost is the combined cost or weighted average cost of various sources of capital. Marginal cost refers to the average cost of new or additional funds required by a firm. It is the marginal cost which should be taken into consideration in investment decisions.

### Computation of Cost of Capital

Computation of cost capital of a firm involves the following steps:

- (i) Computation of cost of specific sources of a capital, viz., debt, preference capital, equity and retained earnings, and
- (ii) Computation of weighted average cost of capital.

#### I. Computation of specific sources of capital

##### Cost of Debt ( $k_d$ )

Debt may be perpetual or redeemable debt. Moreover, it may be issued at par, at premium or discount. The computation of cost debt in each case is explained below.

##### Perpetual / Irredeemable debt

It is the rate of return which the lenders expect. A firm may issue perpetual bonds or it may have a policy of having a fixed amount of debt in the capital structure. In the case, when the old debt is repaid, it would be replaced by a new debt of same amount. In such a case debt is regarded as perpetual debt. The bonds of debentures can be issued at par, (face value), discount (below face value) and premium (more than the face value). Thus, cost of perpetual debt is equal to the rate of return expected by the lenders. It is the coupon rate of interest which is adjusted for tax effect.

Cost of perpetual debt can be determined as before tax cost of debt and after tax cost of debt. Symbolically:

$$= \frac{\text{Interest}}{\text{Sale price of debenture of bond (p)}}$$

$$\text{After tax cost of debt (K}_d) = \frac{I}{P} (1 - t)$$

I – Interest payment

P - Sale price of bond or debenture

t – Tax rate

##### Cost of Redeemable debt:

While calculating the cost of redeemable debt, it is necessary to consider the repayment of the principal in addition to interest payments. The cost of redeemable debt can be calculated by using the following formula.



$$\text{After - tax cost of debt, } K_d = \frac{I(1-t) + \frac{(F-S)}{n}}{\frac{(F+S)}{2}}$$

Where

I = Annual Interest charges

t = Tax rate

n = Number of years

F = Redeemable value of the debt at the time of maturity.

S = Net sale proceeds from the issue of debt (face value – expenses)

### Illustration: 1

A Company issued 10,000, 10% debentures of ₹100 each at a premium of 10% on 01.04.2018 to be matured on 01.04.2023. The debentures will be redeemed on maturity.

Compute the cost of debentures assuming 35% as tax rate.

### Solution:

The cost of debenture ( $K_d$ ) will be calculated as follows:

$$\text{Cost of debenture } (K_d) = \frac{I(1-t) + \frac{(RV - NP)}{n}}{\frac{(RV + NP)}{2}}$$

I	= Interest on debenture = 10% of ₹100	= ₹10
NP	= Net Proceeds = 110% of ₹100	= ₹110
RV	= Redemption value	= ₹100
n	= Period of debenture	= 5 years
t	= Tax rate	= 35% or 0.35

$$K_d = \frac{₹10(1-0.35) + \frac{(₹100 - ₹110)}{5\text{years}}}{\frac{(₹100 + ₹110)}{2}}$$

$$\text{Or } K_d = \frac{₹10 \times 0.65 - ₹2}{₹105} = \frac{₹4.5}{₹105} = 0.0428 \text{ or } 4.28\%$$



**Illustration: 2**

A company issued 10,000, 10% debentures ₹ 100 each on 01.04.2018 to be matured on 01.04.2023. The company wants to know the current cost of its existing debt. The market price of the debentures is ₹ 80. Compute the cost of existing debentures assuming 35% tax rate.

**Solution:**

$$\text{Cost of debenture } (K_d) = \frac{I(1-t) + \frac{(RV - NP)}{n}}{\frac{(RV + NP)}{2}}$$

- I = Interest on debenture = 10% of ₹100 = ₹10
- NP = Current market price = ₹80
- RV = Redemption value = ₹100
- n = Period of debenture = 5 years
- t = Tax rate = 35% or 0.35

$$K_d = \frac{₹10(1-0.35) + \frac{(₹100 - ₹80)}{5 \text{ years}}}{\frac{(₹100 + ₹80)}{2}}$$

$$\text{Or } K_d = \frac{₹10 \times 0.65 + ₹4}{₹90} = \frac{₹10.5}{₹90} = 0.1166 \text{ or } 11.67\%$$

**Cost of Debt using Present value method [Yield to maturity (YTM) approach]**

The cost of redeemable debt ( $K_d$ ) is also calculated by discounting the relevant cash flows using Internal rate of return (IRR). Here YTM is the annual return of an investment from the current date till maturity date. So, YTM is the internal rate of return at which current price of a debt equals to the present value of all cash flows.

The relevant cash flows are as follows:

Year	Cash flows
0	Net proceeds in case of new issue/ current market price in case of existing debt (NP or $P_0$ )
1 to n	Interest net of tax [ $I(1 - t)$ ]
n	Redemption value (RV)

**Steps to calculate relevant cash flows:**

- Step-1:** Identify the cash flows
- Step-2:** Calculate NPVs of cash flows as identified above using two discount rates
- Step-3:** Calculate IRR



**Example:** A company issued 10,000, 10% debentures of ₹100 each on 1.04.2017 to be matured on 1.04.2022. The company wants to know the current cost of its existing debt and the market price of the debentures is ₹ 80. Compute the cost of existing debentures assuming 35% tax rate.

**Step-1: Identification of relevant cash flows**

Year	Cash flows
0	Current market price ( $P_0$ ) = ₹80
1 to 5	Interest net of tax $[I(1 - t)] = 10\%$ of ₹100 $(1 - 0.35) = ₹6.5$
5	Redemption value (RV) = Face value i.e. ₹100

**Step- 2: Calculation of NPVs at two discount rates**

Year	Cash flows	Discount factor @ 10%	Present value	Discount factor @ 15%	Present value
0	80	1.000	(80.00)	1.000	(80.00)
1 to 5	6.5	3.791	24.64	3.352	21.79
5	100	0.621	62.10	0.497	49.70
NPV			+6.74		-8.51

**Step- 3: Calculation of IRR**

$$IRR = L + \frac{NPV_L}{NPV_L - NPV_H} (H - L) = 10\% + \frac{6.74}{6.74 - (-8.51)} (15\% - 10\%) = 12.21\%$$

YTM or present value method is a superior method of determining cost of debt as compared to approximation method and it is also preferred in the field of finance.

**Amortisation of Bond**

A bond may be amortised every year i.e. principal is repaid every year rather than at maturity. In such a situation, the principal will go down with annual payments and interest will be computed on the outstanding amount. The cash flows of the bonds will be uneven.

The formula for determining the value of a bond or debenture that is amortised every year is as follows:

$$V_B = \frac{C_1}{(1+K_d)^1} + \frac{C_2}{(1+K_d)^2} + \dots + \frac{C_n}{(1+K_d)^n}$$

$$V_B = \sum_{t=1}^n \frac{C_t}{(1+K_d)^t}$$

**Illustration: 3**

XYZ Ltd. is proposing to sell a 5-year bond of ₹ 5,000 at 8 per cent rate of interest per annum. The bond amount will be amortised equally over its life. What is the bond's present value for an investor if he expects a minimum rate of return of 6 per cent?





**Solution:**

The amount of interest will go on declining as the outstanding amount of bond will be reducing due to amortisation. The amount of interest for five years will be:

First year	: ₹5,000 × 0.08	= ₹ 400
Second year	: (₹5,000 - ₹1,000) × 0.08	= ₹ 320
Third year	: (₹4,000 - ₹1,000) × 0.08	= ₹ 240
Fourth year	: (₹3,000 - ₹1,000) × 0.08	= ₹ 160
Fifth year	: ₹2,000 - ₹1,000) × 0.08	= ₹ 80

The outstanding amount of bond will be zero at the end of fifth year.

Since XYZ Ltd. will have to return ₹1,000 every year, the outflows every year will consist of interest payment and repayment of principal:

First year	: ₹ 1,000 + ₹ 400	= ₹ 1,400
Second year	: ₹ 11,000 + ₹ 320	= ₹ 1,320
Third year	: ₹ 1,000 + ₹ 240	= ₹ 1,240
Fourth year	: ₹ 1,000 + ₹ 160	= ₹ 1,160
Fifth year	: ₹ 1,000 + ₹80	= ₹ 1,080

The above cash flows of all five years will be discounted with the cost of capital. Here the expected rate i.e. 6% will be used.

Value of the bond is calculated as follows:

$$\begin{aligned}
 V_B &= \frac{₹1,400}{(1.06)^1} + \frac{₹1,320}{(1.06)^2} + \frac{₹1,240}{(1.06)^3} + \frac{₹1,160}{(1.06)^4} + \frac{₹1,080}{(1.06)^5} \\
 &= \frac{₹1,400}{1.06} + \frac{₹1,320}{1.1236} + \frac{₹1,240}{1.1910} + \frac{₹1,160}{1.2624} + \frac{₹1,080}{1.3382} \\
 &= ₹1,320.75 + ₹1,174.80 + ₹1,041.14 + ₹918.88 + ₹807.05 = ₹ 5,262.62
 \end{aligned}$$

**Cost of Convertible Debenture**

Holders of the convertible debentures has the option to either get the debentures redeemed into the cash or get specified numbers of companies' shares in lieu of cash. The calculation of cost of convertible debentures is very much similar to the redeemable debentures. While determining the redeemable value of the debentures, it is assumed that all the debenture holders will choose the option which has the higher value and accordingly it is considered to calculate cost of debt.

**Example:** A company issued 10,000, 15% Convertible debentures of ₹100 each with a maturity period of 5 years. At maturity the debenture holders will have the option to convert the debentures into equity shares of the company in the ratio of 1:10 (10 shares for each debenture). The current market price of the equity shares is ₹12 each and historically the growth rate of the shares are 5% per annum. Compute the cost of debentures assuming 35% tax rate.

**Determination of Redemption value:**

Higher of

- (i) The cash value of debentures = ₹100



$$\begin{aligned} \text{(ii) Value of equity shares} &= 10 \text{ shares} \times ₹12 (1 + 0.05)^5 \\ &= 10 \text{ shares} \times 15.312 = ₹153.12 \end{aligned}$$

₹153.12 will be taken as redemption value as it is higher than the cash option and attractive to the investors.

Calculation of Cost of Convertible debenture (using approximation method):

$$K_d = \frac{1(1-t) + \frac{(RV - NP)}{n}}{\frac{(RV + NP)}{2}} = \frac{15(1-0.35) + \frac{(153.12 - 100)}{5}}{\frac{(153.12 + 100)}{2}} = \frac{9.75 + 10.62}{126.53} = 16.09\%$$

### Alternatively:

Using present value method

Year	Cash flows	Discount factor @ 15%	Present value	Discount factor @ 20%	Present value
0	100	1.000	(100.00)	1.000	(100.00)
1 to 5	9.75	3.352	32.68	2.991	29.16
5	153.12	0.497	76.10	0.402	61.55
NPV			+8.78		-9.29

$$IRR = L + \frac{NPV_L}{NPV_L - NPV_H} (H - L) = 15\% + \frac{8.78}{8.78 - (-9.29)} (20\% - 15\%) = 10.17429 \text{ or } 17.43\%$$

### Cost of Preference Capital ( $K_p$ )

The computation of cost of preference shares is conceptually difficult when compared to the cost of debt. Preference share holders have a preference regarding the payment of dividend as well as return of principal amount over the ordinary shares. Preference capital carries a fixed rate of dividend.

Preference dividend is an appropriation of earnings after the payment of taxes. Therefore, there is no need to make any adjustment for taxes while determining the cost of preference shares ( $K_p$ ).

#### Perpetual Preference Capital:

$$K_p = \frac{D(1 + dt)}{NS}$$

Where

D = Preference dividend

dt = Dividend tax

NS = Net Sale proceeds i.e., Issue Price – Flotation Cost.

Redeemable preference shares: It is calculated with the following formula:

$$K_p = \frac{D(1 + dt) + \frac{RV - NS}{n}}{\frac{RV + NS}{2}} \times 100$$



Where,

- $K_p$  = Cost of preference capital
- D = Annual preference dividend
- RV = Maturity value of preference shares
- NS = Net proceeds of preference shares
- N = Number of years to maturity

### Cost of Redeemable Preference Shares

Preference shares issued by a company which are redeemed on its maturity is called redeemable preference shares. Cost of redeemable preference share is similar to the cost of redeemable debentures with the exception that the dividends paid to the preference shareholders are not tax deductible. Cost of preference capital is calculated as follows:

$$\text{Cost of Redeemable Preference Share } (K_p) = \frac{PD + \frac{(RV - NP)}{n}}{\frac{(RV + NP)}{2}}$$

Where,

- PD = Annual preference dividend
- RV = Redemption value of preference shares
- NP = Net proceeds on issue of preference shares
- n = Life of preference shares

The cost of redeemable preference share can also be calculated as the discount rate that equates the net proceeds of the sale of preference shares with the present value of the future dividends and principal payments.

### Illustration: 4

ABC Ltd. issues 2,000 10% preference shares of ₹ 100 each at ₹ 95 each. The company proposes to redeem the preference shares at the end of 10th year from the date of issue.

Calculate the cost of preference share.

### Solution:

$$(K_p) = \frac{PD + \frac{(RV - NP)}{n}}{\frac{(RV + NP)}{2}}$$

$$(K_p) = \frac{10 + \left(\frac{100 - 95}{10}\right)}{\left(\frac{100 + 95}{2}\right)} = 0.1077 \text{ (approx.)} = 10.77\%$$

### Cost of Irredeemable Preference Shares

The cost of irredeemable preference shares is similar to calculation of perpetuity. The cost is calculated by dividing the preference dividend with the current market price or net proceeds from the issue. The cost of irredeemable preference share is calculated as follows:



$$\text{Cost of Irredeemable Preference Share } (K_p) = \frac{PD}{P_0}$$

Where,

PD = Annual preference dividend

$P_0$  = Net proceeds in issue of preference shares

#### Illustration: 5

ABC & Co. Ltd. issues 2,000 10% preference shares of ₹100 each at ₹95 each.

Calculate the cost of preference shares.

#### Solution:

$$(K_p) = \frac{PD}{P_0}$$

$$(K_p) = \frac{(10 \times 2,000)}{(95 \times 2,000)} = \frac{10}{95} = 0.1053 = 10.53\%$$

#### Illustration: 6

If Reliance Energy Ltd. is issuing preferred stock at ₹100 per share, with a stated dividend of ₹12, and a flotation cost of 3% then, what is the cost of preference share?

#### Solution:

$$K_p = \frac{\text{Preferred stock dividend}}{\text{Market price of preferred stock (1-floatation cost)}}$$
$$= \frac{₹12}{₹100(1-0.03)} = \frac{₹12}{₹97} = 0.1237 \text{ or } 12.37\%$$

### Cost of Equity Capital

The cost of Equity Capital is most difficult to compute. Some people argue that the equity capital is cost free as the Company is not legally bound to pay the dividends to Equity shareholders. But this is not true. Shareholders will invest their funds with the expectation of dividends. The market value of Equity Share depends in the dividends expected by shareholders. Thus the required rate of return which equates the present value of the expected dividends with the market value of Equity share is the cost of Equity Capital. The cost of Equity Capital may be expressed as the minimum rate of return that must be earned on New Equity Share Capital financed investment in order to keep the earnings available to the existing Equity shareholders of the firm unchanged.

It may be computed in the following 4 methods.

#### (a) Dividend method (no growth model)

As stated above, the market price per share depends on the dividends expected by the Equity Shareholders.



Formula:

$$P_0 = \frac{D_1}{(1+K_e)} + \frac{D_2}{(1+K_e)^2} + \dots + \frac{D_n}{(1+K_e)^n}$$

Or

$$K_e = \frac{D_1}{NS}$$

Where

$K_e$  = Cost of Equity

D = Dividend

NS = Net Sale Proceeds i.e., Issue Price – Flotation Cost

### (b) Constant growth model (Gordan Model)

When the dividends are expected to grow at a rate of 'g' annually, the following formula is used:

$$P_0 = \frac{D_0(1+g)}{(1+K_e)} + \frac{D_2(1+g)^2}{(1+K_e)^2} + \dots + \frac{D_0(1+g)^n}{(1+K_e)^n}$$

Or

$$K_e = \frac{D_1}{P_0} + g$$

Where

$K_e$  = Cost of Equity

D = Dividend

$P_0$  = Issue price of share or current market price.

g = Growth rate

**Note:** If flotation costs such as underwriting commission, brokerage fees etc. is considered  $P_0$  is replaced with NS.

NS = Current market price or cost of issue – flotation cost

### Illustration: 7

A company has paid dividend of ₹1 per share (of face value of ₹10 each) last year and it is expected to grow @ 70% next year. Calculate the cost of equity if the market price of share is ₹ 55.

**Solution:**

$$K_e = \frac{D_1}{P_0} + g = \frac{₹1(1+0.1)}{₹55} + 0.1 = 0.12 = 12\%$$

**(c) Earning Model**

The cost of equity is also measured by Earnings / Price ratio. It is the ratio of EPS to market price per share.

**Formula:**

$$K_e = \frac{\text{EPS}}{\text{NS}}$$

Where

$K_e$  = Cost of Equity

NS = Net Sale Proceeds i.e., Issue Price – Flotation Cost

**Estimation of Growth Rate**

The calculation of 'g' (the growth rate) is an important factor in calculating cost of equity share capital. Generally two methods are used to determine the growth rate, which are discussed below:

**(i) Average Method**

It is calculated in the following manner:

Current Dividend ( $D_0$ ) =  $D_n (1 + g)^n$  or

$$\text{Growth rate (g)} = \sqrt[n]{\frac{D_0}{D_n}} - 1$$

Where,

$D_0$  = Current dividend

$D_n$  = Dividend in n years ago

Growth rate can also be calculated as follows:

**Step-I:** Divide  $D_0$  by  $D_n$ , find out the result, then refer the FVIF table

**Step-II:** Find out the result found at Step-I in corresponding year's row

**Step-III:** See the interest rate for the corresponding column. This is the growth rate.

**Example:** The current dividend ( $D_0$ ) is ₹16.10 and the dividend 5 year ago was ₹10. The growth rate in the dividend can be calculated as follows:

**Step-I:** Divide  $D_0$  by  $D_n$  i.e. ₹16.10 ÷ ₹10 = 1.61

**Step-II:** Find out the result found at Step-I i.e. 1.61 in corresponding year's row i.e. 5<sup>th</sup> year

**Step-III:** See the interest rate for the corresponding column which is 10%. Therefore, growth rate (g) is 10%.

**(ii) Gordon's Growth Model**

Unlike the Average method, Gordon's growth model attempts to derive a future growth rate. As per this model increase in the level of investment will give rise to an increase in future dividends. This model takes Earnings retention rate (b) and rate of return on investments (r) into account to estimate the future growth rate.

It can be calculated as follows:

Growth (g) =  $b \times r$



Where,

$r$  = rate of return on fund invested

$b$  = earnings retention ratio/ rate\*

\*Proportion of earnings available to equity shareholders which is not distributed as dividend.

### Realised Yield Approach

According to this approach, the average rate of return realised in the past few years is historically regarded as 'expected return' in the future. It computes cost of equity based on the past records of dividends actually realised by the equity shareholders. Though, this approach provides a single mechanism of calculating cost of equity, it has unrealistic assumptions like risks faced by the company remain same; the shareholders continue to expect the same rate of return. The reinvestment opportunity cost (rate) of the shareholders is same as the realised yield. If the earnings do not remain stable, this method is not practical.

### Illustration: 8

Dr. Nandy had purchased a share of Alxa Limited for ₹1,000. He received dividend for a period of five years at the rate of 10 percent. At the end of the fifth year, he sold the share of Alxa Limited for ₹1,128. You are required to compute the cost of equity as per realised yield approach.

### Solution:

As per the realised yield approach, cost of equity is equal to the realised rate of return. Therefore, it is important to compute the internal rate of return by trial and error method. This realised rate of return is the discount rate which equates the present value of the dividends received in the past five years plus the present value of sale price of ₹1,128 to the purchase price of ₹1,000. The discount rate which equalises these two is 12 percent approximately. Let us look at the table given for a better understanding:

Year	Dividend (₹)	Sale Proceeds (₹)	Discount Factor @ 12%	Present Value (₹)
1	100	-	0.893	89.3
2	100	-	0.797	79.7
3	100	-	0.712	71.2
4	100	-	0.636	63.6
5	100	-	0.567	56.7
6	Beginning	1,128	0.567	639.576
				1,000.076

We find that the purchase price of Alxa limited's share was ₹1,000 and the present value of the past five years of dividends plus the present value of the sale price at the discount rate of 12 per cent is ₹1,000.076. Therefore, the realised rate of return may be taken as 12 percent. This 12 percent is the cost of equity.

### (d) Capital Asset Pricing Model

Another technique that can be used to estimate the cost of equity is the capital asset pricing model approach. The capital asset pricing model explains the behaviour of security prices and provides a mechanism whereby investors could assess the impact of a proposed security investment on their overall portfolio risk and return. In other words, CAPM formally describes the risk–required return trade off for securities. The assumptions for CAPM approach are:

- (i) The efficiency of the security
- (ii) Investor preferences.

The capital asset pricing model describes the relationship between the required rate of return, or the cost of equity capital and the non-diversifiable or relevant risk of the firm as reflected in its index of non-diversifiable risk.

Symbolically,

$$K_e = R_f + \beta (R_m - R_f)$$

Where

$K_e$  = Cost of equity capital

$R_f$  = Risk – free rate of return

$R_m$  = Return on market portfolio

$\beta$  = Beta of Security

The risks, to which a security is exposed, can be classified into two groups:

- (i) *Unsystematic Risk*: This is also called company specific risk as the risk is related with the company's performance. This type of risk can be reduced or eliminated by diversification of the securities portfolio. This is also known as diversifiable risk.
- (ii) *Systematic Risk*: It is the macro-economic or market specific risk under which a company operates. This type of risk cannot be eliminated by the diversification hence, it is non-diversifiable. The examples are inflation, Government policy, interest rate etc.

As diversifiable risk can be eliminated by an investor through diversification, the non-diversifiable risk is the risk which cannot be eliminated. Therefore a business should be concerned as per CAPM method, solely with non-diversifiable risk.

The non-diversifiable risks are assessed in terms of beta coefficient (b or  $\beta$ ) through fitting regression equation between return of a security and the return on a market portfolio.

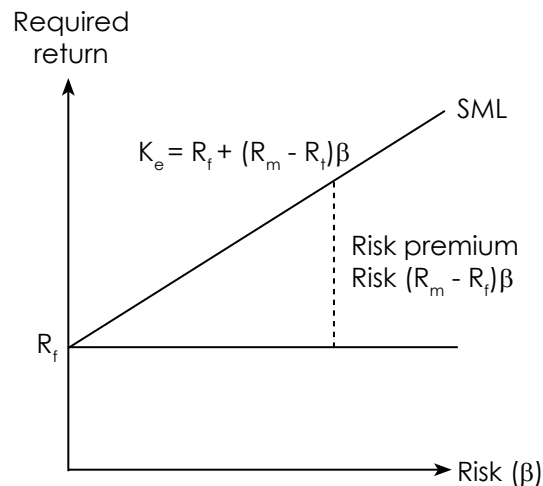

**Cost of Equity under CAPM**

Thus, the cost of equity capital can be calculated under this approach as:

$$\text{Cost of Equity } (K_e) = R_f + \beta (R_m - R_f)$$





Where,

$K_e$  = Cost of equity capital

$R_f$  = Risk free rate of return

$\beta$  = Beta coefficient

$R_m$  = Rate of return on market portfolio

$(R_m - R_f)$  = Market premium

Therefore, required rate of return = Risk free rate + Risk premium

- The idea behind CAPM is that investors need to be compensated in two ways- time value of money and risk.
- The time value of money is represented by the risk-free rate in the formula and compensates the investors for placing money in any investment over a period of time.
- The other half of the formula represents risk and calculates the amount of compensation the investor needs for taking on additional risk. This is calculated by taking a risk measure (beta) which compares the returns of the asset to the market over a period of time and compares it to the market premium.

According to the CAPM the expected return of a security or a portfolio equals the rate on a risk-free security plus a risk premium. If this expected return does not meet or beat the required return, then the investment should not be undertaken. The limitations of this approach are:

- Estimation of betas with historical data is unrealistic; and
- Market imperfections may lead investors to unsystematic risk.

Despite these shortcomings, the CAPM is useful in calculating cost of equity even when the firm is suffering losses.

The basic factor behind determining the cost of equity share capital is to measure the expectation of investors from the equity shares of that particular company. Therefore, the whole question of determining the cost of equity shares depends upon the factors which go into the expectations of particular group of investors in a company of a particular risk class.

#### Illustration: 9

Calculate the cost of equity capital of HUL Ltd., whose risk free rate of return equals 10%. The company's beta equals 1.75 and the return on the market portfolio equals to 15%.

#### Solution:

$$K_e = R_f + \beta(R_m - R_f)$$

$$K_e = 0.10 + 1.75(0.15 - 0.10)$$

$$= 0.10 + 1.75(0.05)$$

$$= 0.1875 \text{ or } 18.75\%$$

#### Cost of Retained Earnings ( $K_r$ )

Retained earnings refer to undistributed profits of a firm. Out of the total earnings, firms generally distribute only part of them in the form of dividends and the rest will be retained within the firms. Since no dividend is required to be paid on retained earnings, some people feel that 'retained earnings carry no cost'. But this approach is not appropriate. Retained earnings has the opportunity cost of dividends from alternative investment. Hence, shareholders expect a return on retained earnings at least equity.

$$K_r = K_e$$



The cost of retained earnings is often used interchangeably with the cost of equity as cost of retained earnings is nothing but the expected return of the shareholders from the investment in shares of the company. However, sometime cost of retained earnings remains below the cost of equity due to saving in floatation cost and existence of personal tax.

The Cost of Retained Earnings ( $K_s$ ) is calculated as follows:

In absence of any information on personal tax ( $t_p$ ):

Cost of Retained Earnings ( $K_s$ ) = Cost of Equity Shares ( $K_e$ )

If there is any information on personal tax ( $t_p$ ):  $K_s = K_e - t_p$

*Floatation Cost:* The new issue of a security (debt or equity) involves some expenditure in the form of underwriting or brokerage fees, legal and administrative charges, registration fees, printing expenses etc. The sum of all these cost is known as floatation cost.

This expenditure is incurred to make the securities available to the investors. Floatation cost is adjusted to arrive at net proceeds for the calculation of cost of capital.

### Illustration: 10

RIL Ltd. provides the following details:

$$D_0 = ₹4.19 \quad P_0 = ₹50 \quad g = 5\%$$

Calculate the cost of retained earnings.

### Solution:

$$\begin{aligned} K_s &= \frac{D_1}{P_0} + g = \frac{D_0(1+g)}{P_0} + g \\ &= \frac{₹4.19(1+0.05)}{₹50} + 0.05 \\ &= 0.088 + 0.05 = 13.8\% \end{aligned}$$

### Illustration: 11

MNC Ltd. provides the following details:

$$R_f = 7\% \quad \beta = 1.20 \quad R_m - R_f = 6\%$$

Calculate the cost of retained earnings based on CAPM method.

### Solution:

$$\begin{aligned} K_s &= R_f + \beta (R_m - R_f) \\ &= 7\% + 1.20 (6\%) \\ &= 7\% + 7.20 \\ K_s &= 14.2\% \end{aligned}$$

### Cost of Rights Issue

When the shares are offered to the existing shareholders in proportion to the existing shareholding, it is called "Rights issue". Then the existing shareholders will have right to subscribe first. Balance, if any left over, will be offered to public for subscription or private placement, etc.

**Formula:**

When he sells ex-rights (i.e. after exercising the option):

$$P = \frac{MN + Sr}{N + r}$$

When

P = Theoretical market price of the share when he sells ex-rights

M = market price of the share when it is sold cum – rights

N= Number of existing shares

S = Subscription price per share

r = No. of right shares

**Value of right = Cum-right share price – Ex- right share price****Effective Interest Rate (EIR) Method**

Effective Interest Rate is the rate that exactly discounts estimated future cash payments or receipts through the expected life of the financial asset or financial liability to the gross carrying amount of a financial asset or to the amortised cost of a financial liability. While calculating the effective interest rate, an entity shall estimate the expected cash flows by considering all the contractual terms of the financial instrument (for example, prepayment, extension, call and similar options) but shall not consider the expected credit losses (ECL). The calculation includes all fees and points paid or received between parties to the contract that are an integral part of the effective interest rate, transaction costs, and all other premiums or discounts. There is a presumption that the cash flows and the expected life of a group of similar financial instruments can be estimated reliably. However, in those rare cases when it is not possible to reliably estimate the cash flows or the expected life of a financial instrument (or group of financial instruments), the entity shall use the contractual cash flows over the full contractual term of the financial instrument (or group of financial instruments).

For floating (variable)-rate financial assets or financial liabilities, periodic re-estimation of cash flows to reflect the movements in the market rates of interest alters the effective interest rate. If the floating (variable)-rate financial asset or financial liability is recognised initially at an amount equal to the principal receivable or payable on maturity, re-estimating the future interest payments normally has no significant effect on the carrying amount of the asset or the liability.

So, depending on materiality an appropriate approach for amortisation can be determined. If the amount of transaction costs, premiums or discount is not significant the straight line amortisation can be done if the amounts are significant EIR rate, for amortising these amounts may be applied.

**Weighted Average Cost of Capital**

Weighted Average Cost of Capital is the average cost of capital of the firm's existing operations. It is computed by weighing the cost of each individual source of capital (viz. debt, equity share etc.) in proportion to the total market value of the firm.

It is the average of the costs of several of sources of financing. It is also known as composite or overall or Average Cost of Capital. After computing the cost of individual sources of finance, the Weighted Average Cost of Capital is calculated by putting weights in the proportion of the various sources of funds to the total.

Weighted average cost of capital is computes by using either of the following two types of weights:

1. Market value
2. Book Value



Market value weights are sometimes preferred to the book value weights as the market value represents the true value of the investors. However, market value weights suffer from the following limitations:

- (i) Market values are subject to frequent fluctuations.
- (ii) Equity capital gets more importance, with the use of market value weights.

Moreover, book values are readily available.

Average cost of capital is computed as followings:

$$K_w = W_e K_e + W_d K_d + W_p K_p + W_r K_r$$

Where,

$K_w$  = Weighted Average Cost of Capital

$K_e$  = Cost of Equity

$K_r$  = Cost of Reserves

$K_d$  = Cost of Debt

$K_p$  = Cost of preference share capital

W = weights (proportions of specific sources of finance in the total)

The following steps are involved in the computation of Weighted Average Cost of Capital:

- (i) Multiply the cost of each sources with the corresponding weight.
- (ii) Add all these weighted costs so that weighted average cost of capital is obtained.

Example:

**Calculation of WACC**

Capital Component	Cost of capital	% of total capital structure	Total
Retained Earnings	10% ( $K_r$ )	25% ( $W_r$ )	2.50% ( $K_r \times W_r$ )
Equity Share Capital	11% ( $K_e$ )	10% ( $W_e$ )	1.10% ( $K_e \times W_e$ )
Preference Share Capital	9% ( $K_p$ )	15% ( $W_p$ )	1.35% ( $K_p \times W_p$ )
Long term debts	6% ( $K_d$ )	50% ( $W_d$ )	3.00% ( $K_d \times W_d$ )
Total (WACC)			7.95%

The cost of weighted average method is preferred because the proportions of various sources of funds in the capital structure are different. To be representative, therefore, cost of capital should take into account the relative proportions of different sources of finance.

In discounted cash flow analysis, WACC is used as the discount rate applied to future cash flows for deriving a business's net present value. WACC can be used as a hurdle rate against which to assess return on investment capital performance. Investors use WACC as a tool to decide whether or not to invest. The WACC represents the minimum rate of return at which a company produces value for its investors.

Therefore, WACC serves as a useful reality check for investors. But there are problems in determination of weighted average cost of capital. These mainly relate to:-

1. Computation of equity capital and;
2. Assignment of weights to the cost of specific source of financing. Assignment of weights can be possible either on the basis of historical weighting or marginal weighting.



### Choice of weights

There is a choice of weights between the book value (BV) and market value(MV).

**Book Value (BV):** Book value weights is operationally easy and convenient. While using BV, reserves such as share premium and retained profits are included in the BV of equity, in addition to the nominal value of share capital. Here the value of equity will generally not reflect historic asset values, as well as the future prospects of an organisation.

**Market Value(MV):** Market value weight is more correct and represent a firm's capital structure. It is preferable to use MV weights for the equity. While using MV, reserves such as share premium and retained profits are ignored as they are in effect incorporated into the value of equity. It represents existing conditions and also take into consideration the impacts of changing market conditions and the current prices of various security. Similarly, in case of debt MV is better to be used rather than the BV of the debt, though the difference may not be very significant.

### Illustration: 12

Calculate the WACC using the following data by using:

- (a) Book value weights
- (b) Market value weights

The capital structure of the company is as under:

	(₹)
Debentures (₹ 100 per debenture)	5,00,000
Preference shares (₹100 per share)	5,00,000
Equity shares (₹10 per share)	10,00,000
<b>Total</b>	<b>20,00,000</b>

The market prices of these securities are:

- Debentures ₹ 105 per debenture
- Preference shares ₹ 110 per preference share
- Equity shares ₹ 24 each.

Additional information:

- (1) ₹ 100 per debenture redeemable at par, 10% coupon rate, 4% floatation costs, 10 year maturity
- (2) ₹ 100 per preference share redeemable at par, 5% coupon rate, 2% floatation cost and 10 year maturity
- (3) Equity share has ₹ 4 floatation cost and market price ₹ 24 per share.

The next year expected dividend is ₹ 1 with annual growth of 5%. The firm has practice of paying all earnings in the form of dividend.

Corporate tax rate is 50%.

### Solution:

$$\text{Cost of Equity } (K_e) = \frac{D_1}{P_0 - F} + g = \frac{₹ 1}{₹ 24 - ₹ 4} + 0.05 = 0.1 \text{ or } 10\%$$



$$\text{Cost of Debt } (K_e) = \frac{1(1-t) + \frac{(RV - NP)}{n}}{\frac{(RV + NP)}{2}} = \frac{10(1-0.5) + \frac{(100 - NP)}{n}}{\frac{(RV + NP)}{2}}$$

$$\text{Cost of debt } = (K_d) = \frac{10(1-0.5) + \frac{(100 - 96)}{10}}{\frac{(100 + 96)}{2}} = \left( \frac{5 + 0.4}{98} \right) = 0.055 \text{ (approx.)}$$

$$\text{Cost of preference shares } = K_p = \left[ \frac{5 + \frac{2}{10}}{\frac{198}{2}} \right] = \left( \frac{5.2}{99} \right) = 0.053 \text{ (approx.)}$$

**(a) Calculation of WACC using book value weights**

Source of capital	Book Value	Weights	After tax cost of capital	WACC ( $K_0$ )
		(a)	(b)	(c) = (a) × (b)
10% Debentures	5,00,000	0.25	0.055	0.0137
5% Preference shares	5,00,000	0.25	0.053	0.0132
Equity shares	10,00,000	0.50	0.10	0.0500
	20,00,000	1.00		0.0769

WACC ( $K_0$ ) = 0.0769 or 7.69%

**(b) Calculation of WACC using market value weights**

Share of capital	Market value	Weights	After tax cost of capital	WACC ( $K_0$ )
		(a)	(b)	(c) = (a) × (b)
10% Debentures (₹105 × 5,000)	5,25,000	0.151	0.055	0.008
5% Preference shares (₹110 × 5,000)	5,50,000	0.158	0.053	0.008
Equity shares (₹24 × 1,00,000)	24,00,000	0.691	0.10	0.069
	34,75,000	1.000		0.085

WACC ( $K$ ) = 0.085 or 8.5%

**Marginal Cost of Capital**

The Marginal Cost of Capital may be defined as the cost of raising an additional rupee of capital. It is referred to as the cost incurred in raising new funds.

The weighted average cost of capital can be worked out on the basis of marginal cost of capital than the historical costs. The weighted average cost of new or incremental capital is known as the marginal cost of capital. This concept is used in capital budgeting decisions. The marginal cost of capital is derived, when we calculate the weighted average cost of capital using the marginal weights. The marginal cost of capital would rise whenever any component cost increases. The marginal cost of capital should be used as the cut off rate. The average cost of capital should be used to evaluate the impact of the acceptance or rejection of the entire capital expenditure on the value of the firm.

**Illustration: 13**

XYZ Ltd. has the following capital structure which is considered to be optimum as on 31st March, 2018.

	(₹)
14% Debentures	30,000
11% Preference shares	10,000
Equity Shares (10,000 shares)	1,60,000
	2,00,000

The company's share has a market price of ₹ 23.60. Next year dividend per share is 50% of year 2018 EPS. The following is the trend of EPS for the preceding 10 years which is expected to continue in future.

Year	EPS (₹)	Year	EPS (₹)
2009	1.00	2014	1.61
2010	1.10	2015	1.77
2011	1.21	2016	1.95
2012	1.33	2017	2.15
2013	1.46	2018	2.36

The company issued new debentures carrying 16% rate of interest and the current market price of debenture is ₹ 96.

Preference share of ₹ 9.20 (with annual dividend of ₹ 1.1 per share) were also issued. The company is in 50% tax bracket.

- (I) Calculate after tax:
  - (a) Cost of new debt
  - (b) Cost of new preference shares
  - (c) New equity share (consuming new equity from retained earnings)
- (II) Calculate marginal cost of capital when no new shares are issued.
- (III) How much can be spent for capital investment before new ordinary shares must be sold. Assuming that retained earnings for next year's investment are 50 percent of 2018.
- (IV) What will the marginal cost of capital when the fund exceeds the amount calculated in (III), assuming new equity is issued at ₹ 20 per share?

**Solution:**

- (I) (a) Cost of new debt

$$K_d = \frac{I(1-t)}{P_0} = \frac{16(1-0.5)}{96} = 0.0833$$

- (b) Cost of new preference shares

$$K_p = \frac{PD}{P_0} = \frac{1.1}{9.2} = 0.12$$



$$(c) \text{ Cost of new equity shares } K_e = \frac{D_1}{P_0} + g = \frac{1.18}{23.60} + 0.10 = 0.15$$

Calculation of  $D_1$

$$D_1 = 50\% \text{ of } 2014 \text{ EPS} = 50\% \text{ of } 2.36 = ₹ 1.18$$

(II) Calculation of marginal cost of capital

Type of Capital	Proportion	Specific cost	Product
(1)	(2)	(3)	(2) × (3) = (4)
Debenture	0.15	0.0833	0.0125
Preference Share	0.05	0.12	0.0060
Equity Share	0.80	0.15	0.1200
Marginal cost of capital			0.1385

(III) The company can spend the following amount without increasing marginal cost of capital and without selling the new shares.

$$\text{Retained earnings} = (0.50) (2.36 \times 10,000) = ₹ 11,800$$

The ordinary equity (Retained earnings in this case) is 80% of total capital 11,800

= 80% of Total Capital

$$\therefore \text{Capital investment before issuing equity} = \frac{₹ 11,800}{0.80} = ₹ 14,750$$

(IV) If the company spends in excess of ₹ 14,750 it will have to issue new shares.

$$\therefore \text{Capital investment before issuing equity} = \frac{₹ 1.18}{20} + 0.10 = 0.159$$

The marginal cost of capital will be:

Type of Capital	Proportion	Specific cost	Product
(1)	(2)	(3)	(2) × (3) = (4)
Debenture	0.15	0.0833	0.0125
Preference Share	0.05	0.1200	0.0060
Equity Share	0.80	0.1590	0.1272
			0.1457

#### Illustration: 14

Assuming the corporate tax rate of 35%, compute the after tax cost of capital in the following situations:

- Perpetual 15% Debentures of ₹1,000, sold at a premium of 10% with no flotation costs.
- 10-year 14% Debentures of ₹2,000, redeemable at par, with 5% flotation costs.

#### Solution:

i. Computation of cost of Capital

$$K_d = \frac{I}{P} (1 - t)$$





Where,

I = Interest Payment

P = Sale price of debenture

t = Tax rate

$$K_d = \frac{150(1-0.35)}{1100} \times 100 = 8.86\%$$

ii. Computation of Cost of Capital

$$K_d = \frac{I(1-t) + \frac{RV-NS}{n}}{\frac{RV+NS}{2}} \times 100$$

$$K_d = \frac{280(1-0.35) + \frac{2000-1900}{10}}{\frac{2000+1900}{2}} \times 100$$

$$= 9.85\%$$

Where,

I = Interest Payment

t = Tax rate

RV = Value of debenture Redeemable

NS = Net Sale proceeds

n = No. of years

### Illustration: 15

Calculate the Cost of Capital from the following cases:

- (i) 10-year 14% Preference shares of ₹100, redeemable at premium of 5% and flotation costs 5%. Dividend tax is 10%.
- (ii) An equity share selling at ₹50 and paying a dividend of ₹6 per share, which is expected to continue indefinitely.
- (iii) The above equity share if dividends are expected to grow at the rate of 5%.
- (iv) An equity share of a company is selling at ₹120 per share. The earnings per share is ₹20 of which 50% is paid in dividends. The shareholders expect the company to earn a constant after tax rate of 10% on its investment of retained earnings.

### Solution:

$$i. K_p = \frac{\text{Preference dividend}(1+\text{dividend}) + \frac{RV-NS}{N}}{\frac{RV+NS}{2}} \times 100 = 8.86\%$$



$$K_p = \frac{14(1+0.1) + \frac{105-95}{10}}{\frac{105+95}{2}} \times 100 = 16.4\%$$

ii.  $K_e(\text{no growth model}) = \frac{\text{Dividend}}{\text{Net Sale Proceeds}} \times 100$

$$K_e = \frac{6}{50} \times 100 = 12\%$$

iii.  $K_e(\text{no growth model}) = \frac{D_1}{\text{Net Sale Proceeds}} + \text{Growth}(g)$

$$K_e = \frac{6.3}{50} + 0.05 = 0.176(\text{or}) 17.6\%$$

iv. Market price = ₹ 120

EPS = ₹ 20

Dividend payout ratio = ₹ 10 + 5% of ₹ 10 = ₹ 10.5

$r = 10\%$

$g = \text{Rate of return on retention funds} = b \times r = 10\% \times 50\% = 5\%$

where,

$b = 1 - \text{Payout ratio}$

$r = \text{Return on investment}$

$$K_e = \frac{D_1}{\text{Net Sale Proceeds}} \times 100 + \text{Growth}(g)$$

$$K_e = \frac{10.5}{120} \times 100 + 5\% = 13.75\%$$

### Illustration: 16

From the following information, determine the appropriate weighted average cost of capital, relevant for evaluating long-term investment projects of the company.

Cost of equity	0.18
After tax cost of long-term debt	0.08
After tax cost of short-term debt	0.09
Cost of Reserve	0.15



Sources of capital	Book Value (BV)	Market Value (MV)
<b>Equity:</b>		
Capital	₹3,00,000	₹ 7,50,000
Reserve	2,00,000	-
Long-term debt	4,00,000	3,75,000
Short-term debt	1,00,000	1,00,000
	10,00,000	12,25,000

**Solution:**

**Calculation of Weighted Average Cost of Capital (WACC) or overall Cost of Capital**

**Alternative 1: - Book value as weights**

Element	Amount (₹)	Weight	Specific cost of capital	Overall cost of capital
Capital	3,00,000	0.3333	0.18	0.06
Reserve	2,00,000	0.2222	0.15	0.03
L/T debt	4,00,000	0.4445	0.08	0.04
	9,00,000	1.0000		0.13

Therefore, WACC = 13%

**Alternative 2: - Market value as weights**

Element	Amount (₹)	Weight	Specific cost of capital	Overall cost of capital
Capital	4,50,000	0.40	0.18	0.0720
*Reserve	3,00,000	0.27	0.15	0.0405
L/T debt	3,75,000	0.33	0.08	0.0264
	11,25,000	1.00		0.1389

Therefore, WACC = 13.89%

**\*Note:** Market Value of equity share capital apportioned between capital and reserve in book value weightage.

**Illustration: 17**

In considering the most desirable capital structure of a company, the following estimates of the cost of debt and equity capital (after tax) have been made at various levels of debt-equity mix:

Debt as percentage of total capital employed	Cost of debt %	Cost of equity %
0	5.0	12.0
10	5.0	12.0
20	5.0	12.5
30	5.5	13.0
40	6.0	14.0
50	6.5	16.0
60	7.0	20.0



You are required to determine the optimal debt-equity mix for the company by calculating composite cost of capital.

**Solution:**

Statement showing computation of composite cost of capital ( $K_0$ ) at different levels of debt-equity mix:-

Debt as percentage of total capital employed	Cost of debt %	Cost of equity %	$K_0 = W_e K_e + W_d K_d$
0	5.0	12.0	$(1 \times 12) + (0 \times 5) = 12\%$
10	5.0	12.0	$(0.9 \times 12) + (0.1 \times 5) = 11.30\%$
20	5.0	12.5	$(0.8 \times 12.5) + (0.2 \times 5) = 11\%$
30	5.5	13.0	$(0.7 \times 13) + (0.3 \times 5.5) = 10.75\%$
40	6.0	14.0	$(0.6 \times 14) + (0.4 \times 6) = 10.80\%$
50	6.5	16.0	$(0.5 \times 16) + (0.5 \times 6.5) = 11.25\%$
60	7.0	20.0	$(0.4 \times 20) + (0.6 \times 7) = 12.20\%$

The most desirable or optimal capital structure of the company is 70% equity and 30% debt, as there is overall cost is minimum.

**Illustration: 18**

Determine the weighted average cost of capital using (i) book value weights; and (ii) market value weights based on the following information:

Book value structure:	(₹)
Debentures (₹ 100 per debenture)	8,00,000
Preference share (₹100 per share)	2,00,000
Equity shares (₹ 10 per share)	10,00,000
	20,00,000

Recent market prices of all these securities are:

Debentures: ₹ 110 per debenture;

Preference share: ₹ 120 per share; and

Equity shares: ₹ 22 per share

External financing opportunities are:

- ₹100 per debenture redeemable at par, 10 year maturity, 13% coupon rate, 4% flotation cost and sale price ₹100;
- ₹100 per preference share redeemable at par, 10 year maturity, 14% dividend rate, 5% flotation cost and sale price ₹100; and
- Equity share – ₹2 per share flotation costs and sale price ₹22 Dividend expected on equity share at the end of the year is ₹2 per share; anticipated growth rate in dividend is 7%. Company pays all its earnings in the form of dividends. Corporate tax rate is 50%.

**Solution:**
**Specific cost of capital**

$$K_d = \frac{I(1-t) + \frac{RV - NS}{N}}{\frac{RV + NS}{2}} \times 100$$

$$K_d = \frac{13(1-0.5) + \frac{100-96}{10}}{\frac{100+96}{2}} \times 100 = 7.04\%$$

$$K_p = \frac{\text{Preference dividend} + \frac{RV - NS}{N}}{\frac{RV + NS}{2}} \times 100$$

$$K_p = \frac{14 + \left(\frac{100-95}{10}\right)}{\frac{100+95}{2}} \times 100 = 14.87\%$$

$$K_e = \frac{D_1}{\text{Net Sale Proceeds}} \times 100 + \text{Growth}(g)$$

$$K_p = \frac{2}{20} \times 100 + 7\% = 17\%$$

**WACC**
**Book value basis**

Source	(₹)	Weight	Cost of capital	K <sub>o</sub>
Debentures	8,00,000	0.40	7.04%	2.816
Preference	2,00,000	0.10	14.87%	1.487
Equity	10,00,000	0.50	17.00%	8.500
	20,00,000			12.803%

**Market value basis**

Source	(₹)	Weight	Cost of capital	K <sub>o</sub>
Debentures	8,80,000	0.2649	7.04%	1.865
Preference	2,40,000	0.0722	14.87%	1.074
Equity	22,00,000	0.6629	17.00%	11.270
	33,20,000			14.209%

**Illustration: 19**

The present capital structure of a company is as follows:

	₹ (million)
Equity share (Face value = ₹10)	240
Reserves	360
11% Preference Shares (Face value = ₹10)	120
12% Debentures	120
14% Term Loans	360
	1,200

Additionally the following information are available:

Company's equity beta	1.06
Yield on long-term treasury bonds	10%
Stock market risk premium	6%
Current ex-dividend equity share price	₹15
Current ex-dividend preference share price	₹12
Current ex-interest debenture market value	₹ 102.50 per ₹100
Corporate tax rate	40%

The debentures are redeemable after 3 years and interest is paid annually. Ignoring flotation costs, calculate the company's weighted average cost of capital (WACC).

**Solution:****Specific cost of capital**

$$K_e \text{ (CAPM)} = R_f + \beta (R_m - R_f) = 16.36\%$$

$$R_m - R_f = 6\%$$

$$R_f = 10\%, R_m = 16\%$$

$$K_p = (\text{Dividend} / \text{NS}) \times 100 = (1.1 / 12) \times 100 = 9.17\%$$

$$K_d = \frac{12(1-0.4) + \frac{100-102.5}{3}}{\frac{100+102.50}{2}} \times 100 = 6.29\%$$

**Alternatively,**

$$K_d = \left[ \frac{12 + \frac{100-102.5}{3}}{\frac{100+102.50}{2}} \times 100 \right] \times (1-0.4) = 6.61\%$$

$$K_l = 14\% (1-0.4) = 8.4\%$$

$$K_e = K_e = 16.36\% \text{ (as there is no flotation costs)}$$



## WACC

### Book value basis

Source	(₹) in millions	Weight	Cost of Capital	$K_o$
Equity capital	240	0.20	16.36%	3.272
Reserves	360	0.30	16.36%	4.908
Preference	120	0.10	9.17%	0.917
Debentures	120	0.10	6.61%	0.661
Term loans	360	0.30	8.40%	2.520
	1200	1.00		12.28%

### Market value basis

Source	(₹) in millions	Weight	Cost of Capital	$K_o$
Equity	360	0.3647	16.36%	5.967
Preference	144	0.1459	9.17%	1.338
Debentures	123	0.1246	6.61%	0.824
Term loans	360	0.3648	8.40%	3.064
	987	1.0000		11.18%

### Illustration: 20

Bombay Cotton Mills Limited makes a rights issue at ₹5 a share of one new share for every four shares held. Before the issue, there were 10 million shares outstanding and the share price was ₹6. Based on the above information you are required to compute-

- The total amount of new money raised.
- How many value of one rights are required to buy one new share?
- What is the value of one right?
- What is the prospective ex-rights price?

### Solution:

- Right issue price = ₹5  
 No of right shares issued = 100 lakhs  $\times$  (1/4) = 25 lakh  
 Additional funds raised = 25  $\times$  5 = 125 lakhs
- No of rights required to buy one share = 4 rights
- Value of one right =  $\frac{[6 - (4 \times 6) + (1 \times 5)]}{5} = ₹ 0.20$
- Prospective ex-right share price = ₹5.80

**Illustration: 21**

Aries Limited wishes to raise additional finance of ₹10 lacs for meeting its investment plans. It has ₹2,10,000 in the form of retained earnings available for investment purposes. The following are the further details:

- |  |                 |
|--|-----------------|
| 1. Debt/equity mix   | 30% / 70%       |
| 2. Cost of debt upto ₹1,80,000 10% (before tax) beyond ₹ 1,80,000 16% (before tax) |                 |
| 3. Earnings per share  | ₹ 4             |
| 4. Dividend payout   | 50% of earnings |
| 5. Expected growth rate in dividend  | 10%             |
| 6. Current market price per share  | ₹ 44            |
| 7. Tax rate  | 50%             |

You are required to:

- determine the pattern for raising the additional finance.
  - determine the post-tax average cost of additional debt.
  - determine the cost of retained earnings and cost of equity, and
- Compute the overall weighted average after tax cost of additional finance.

**Solution:**

- (a) Determination of pattern for raising additional finance:

Total additional finance required = ₹10,00,000

Debt Equity mix = 30:70

Therefore

Additional Debt = 10,00,000 x 30% = ₹ 3,00,000

Additional Equity = 10,00,000 x 70% = ₹ 7,00,000

Detailed pattern

Total equity:	(₹)	(₹)
Retained earnings	2,10,000	
Equity share Capital	4,90,000	7,00,000
Debt:		
10% debt	1,80,000	
16% debt	1,20,000	3,00,000
Total Additional finance		10,00,000

- (b) Calculation of Average Cost of additional debt:

Post Tax Cost of 10% debt = 10% (1-0.5) = 5%

Post Tax Cost of 16% debt = 16% (1-0.5) = 8%

Average cost (after tax) of total debt =  $5 \times \frac{1,80,000}{3,00,000} + 8 \times \frac{1,20,000}{3,00,000} = 6.2\%$





(c) Computation of Cost of equity and cost of retained earnings:

$$\begin{aligned} \text{Cost of equity } (K_e) &= \frac{D_1}{P_0} + g \\ &= \frac{2 \times 1.10}{44} + 0.10 = 0.15 \text{ or } 15\% \end{aligned}$$

Cost of Retained Earnings ( $K_r$ )

$K_r = K_e$  (as there is no flotation cost)

$K_r = 15\%$

(d) Calculation of Weighted Cost of Capital

Element	Amount (₹)	Weight	Specific Cost	Overall cost
Equity Share Capital	4,90,000	0.49	0.15	0.0735
Reserves	2,10,000	0.21	0.15	0.0315
10% Debt	1,80,000	0.18	0.05	0.0090
16% Debt	1,20,000	0.12	0.08	0.0096
Total	10,00,000	1.00		0.1236

ACC = 12.36%

## 9.2 CAPITAL STRUCTURE THEORIES

A firm needs funds for long term requirements and working capital. These funds are raised through different sources both short term and long term. The long term funds required by a firm are mobilized through owner's funds (equity share, preference shares and retained earnings) and long term debt (debentures and bonds). A mix of various long term sources of funds employed by a firm is called capital structure.

According to Gerestenberg, "Capital structure of a company refers to the composition or make-up of its capitalization and it includes all long term capital resources, viz, loans, bonds, shares and reserves". Thus capital structure is made up of debt and equity securities and refers to permanent financing of a firm.

Financial Manager has to plan the appropriate mix of different securities in total capitalization in such a way as to minimize the cost of capital and maximize the earnings per share to the equity shareholders. There may be four fundamental patterns of capital structure as follows:

- (i) Equity capital only (including Reserves and Surplus)
- (ii) Equity and preference capital
- (iii) Equity, preference and long term debt i.e. debentures, bonds and loans from financial institutions etc.
- (iv) Equity and long term debt.

Some authors use capital structure and financial structure interchangeably. But, both are different concepts. Financial structure refers to the way in which the total assets of a firm are financed. In other words, financial structure refers to the entire liabilities side of the Balance Sheet. But, capital structure represents only long term sources of funds and excludes all short term debt and current liabilities. Thus, financial structure is a broader one and capital structure is only part of it.



### Features of an Appropriate Capital Structure

A capital structure will be considered to be appropriate if it possesses following features:

- (i) **Profitability:** The capital structure of the company should be most profitable. The most profitable capital structure is one that tends to minimize cost of financing and maximize earnings per equity share.
- (ii) **Solvency:** The pattern of capital structure should be so devised as to ensure that the firm does not run the risk of becoming insolvent. Excess use of debt threatens the solvency of the company. The debt content should not, therefore, be such that which increases risk beyond manageable limits.
- (iii) **Flexibility:** The capital structure should be flexible to meet the requirements of changing conditions. Moreover, it should also be possible for the company to provide funds whenever needed to finance its profitable activities.
- (iv) **Conservatism:** The capital structure should be conservative in the sense that the debt content in the total capital structure does not exceed the limit which the company can bear. In other words, it should be such as is commensurate with the company's ability to generate future cash flows.
- (v) **Control:** The capital structure should be so devised that it involves minimum risk of loss of control of the company.

### Determinants of Capital Structure

The following are the factors influencing the Capital Structure

The capital structure of a firm depends on a number of factors and these factors are of different importance. Generally, the following factors should be considered while determining the capital structure of a company.

#### (i) Trading on equity and EBIT-EPS analysis

The use of long term debt and preference share capital, which are fixed income bearing securities, along with equity share capital is called financial leverage or trading on equity. The use of long term debt capital increases the earnings per share as long as the return on investment is greater than the cost of debt. Preference share capital will also result in increasing EPS. But the leverage effect is more pronounced in case of debt because of two reasons:

1. Cost of debt is usually lower than the cost of preference share capital.
2. The interest paid on debt is tax deductible.

Because of its effects on the earnings per share, financial leverage is one of the important considerations in planning the capital structure of a company. The companies with high level of Earnings Before Interest and Taxes (EBIT) can make profitable use of the high degree of leverage to increase the return on the shareholders equity. The EBIT-EPS analysis is one important tool in the hands of the financial manager to get an insight into the firms capital structure planning. He can analyse the possible fluctuations in EBIT and their impact on EPS under different financing plans.

Under favourable conditions, financial leverage increases EPS, however it can also increase financial risk to shareholders. Therefore, the firm should employ debt to such an extent that financial risk does not spoil the leverage effect.

#### (ii) Growth and stability of sales

This is another important factor which influences the capital structure of a firm. Stability of sales ensures stable earnings, so that the firm will not face any difficulty in meeting its fixed commitments of interest payment and repayment of debt. So the firm can raise a higher level of debt. In the same way, the rate of growth in sales also affects the capital structure decision. Usually, greater the rate of growth of sales, greater can be the use of the debt in the financing of a firm. On the other hand, the firm should be very careful in employing debt capital if its sales are highly fluctuating and declining.



### **(iii) Cost of Capital**

Cost of capital is another important factor that should be kept in mind while designing the capital structure of a firm. The capital structure should be designed in such a way that the firm's overall cost of capital is the minimum. Cost of capital is the minimum return expected by its suppliers. Of all the sources of capital, equity capital is the costliest as the equity shareholders bear the highest risk. On the other hand, debt capital is the cheapest source because the interest is paid on it by the firm whether it makes profits or not. Moreover, interest on debt capital is tax deductible which makes it further cheaper. Preference share capital is also cheaper than equity capital as the dividends are paid at a fixed rate on preference shares. So, the overall cost of capital depends on the proportion in which the capital is mobilized from different sources of finance. Hence, capital structure should be designed carefully so that overall cost of capital is minimized.

### **(iv) Control**

Sometimes, the designing of capital structure of a firm is influenced by the desire of the existing management to retain the control over the firm. Whenever additional funds are required, the management of the firm wants to raise the funds without any loss of control over the firm. If equity shares are issued for raising funds, the control of the existing shareholders is diluted. Because of this, they may raise the funds by issuing fixed charge bearing debt and preference share capital, as preference shareholders and debt holders do not have any voting right. The Debt financing is advisable from the point of view of control. But overdependence on debt capital may result in heavy burden of interest and fixed charges and may lead to liquidation of the company.

### **(v) Flexibility**

Flexibility means the firm's ability to adapt its capital structure to the needs of the changing conditions. Capital structure should be flexible enough to raise additional funds whenever required, without much delay and cost. The capital structure of the firm must be designed in such a way that it is possible to substitute one form of financing for another to economise the use of funds. Preference shares and debentures offer the highest flexibility in the capital structure, as they can be redeemed at the discretion of the firm.

### **(vi) Marketability and timing**

Capital market conditions may change from time to time. Sometimes there may be depression and at other times there may be boom condition in the market. The firm should decide whether to go for equity issue or debt capital by taking market sentiments into consideration. In the case of depressed conditions in the share market, the firm should not issue equity shares but go for debt capital. On the other hand, under boom conditions, it becomes easy for the firm to mobilise funds by issuing equity shares.

The internal conditions of a firm may also determine the marketability of securities. For example, a highly levered firm may find it difficult to raise additional debt. In the same way, a firm may find it very difficult to mobilise funds by issuing any kind of security in the market merely because of its small size.

### **(vii) Floatation costs**

Floatation costs are not a very significant factor in the determination of capital structure. These costs are incurred when the funds are raised externally. They include cost of the issue of prospectus, brokerage, commissions, etc. Generally, the cost of floatation for debt is less than for equity. So, there may be a temptation for debt capital. There will be no floatation cost for retained earnings. As is said earlier, floatation costs are not a significant factor except for small companies.

Floatation costs can be an important consideration in deciding the size of the issue of securities, because these costs as a percentage of funds raised will decline with the size of the issue. Hence, greater the size of the issue more will be the savings in terms of floatation costs. However, a large issue affects the firm's financial flexibility.



### **(viii) Purpose of financing**

The purpose for which funds are raised should also be considered while determining the sources of capital structure. If funds are raised for productive purpose, debt capital is appropriate as the interest can be paid out of profits generated from the investment. But, if it is for unproductive purpose, equity should be preferred.

### **(ix) Legal requirements**

The various guidelines issued by the Government from time to time regarding the issue of shares and debentures should be kept in mind while determining the capital structure of a firm. These legal restrictions are very significant as they give a framework within which capital structure decisions should be made.

### **Essential Features of a Sound Capital Mix**

A sound or an appropriate capital structure should have the following essential features:

- (a) Maximum possible use of leverage
- (b) The capital structure should be flexible.
- (c) To avoid undue financial/business risk with the increase of debt
- (d) The use of debt should be within the capacity of a firm. The firm should be in a position to meet its obligation in paying the loan and interest charges as and when due.
- (e) It should involve minimum possible risk of loss of control.
- (f) It must avoid undue restrictions in agreement of debt.
- (g) The capital structure should be conservative. It should be composed of high grade securities and debt capacity of the company should never be exceeded.
- (h) The capital structure should be simple in the sense that it can be easily managed and also easily understood by the investors.
- (i) The debt should be used to the extent that it does not threaten the solvency of the firm.

### **Optimal Capital Structure**

The theory of optimal capital structure deals with the issue of the right mix of debt and equity in the long term capital structure of a firm. This theory states that if a company takes on debt, the value of the firm increases up to a point. Beyond that point if debt continues to increase then the value of the firm will start to decrease. Similarly, if the company is unable to repay the debt within the specified period then it will affect the goodwill of the company in the market and may create problems for collecting further debt. Therefore, the company should select its appropriate capital structure with due consideration to the factors mentioned earlier.

### **Theories of Capital Structure**

But, the existence of an optimum capital structure is not accepted by all. There are two extreme views or schools of thought regarding the existence of an optimum capital structure. As per one view, capital structure influences the value of the firm and cost of capital and hence there exists an optimum relevance and hence there exists an optimum capital structure. On the other hand, the other school of thought advocates that capital structure has no relevance and it does not influence the value of the firm and cost of capital. Reflecting these views, different theories of capital structure have been developed. The main contributors to the theories are David Durand, Ezra Solomon, Modigliani and Miller.



The important theories of capital structure are:

1. Net Income Approach
2. Net Operating Income Approach
3. The Traditional view
4. Modigliani and Miller hypothesis

### Assumptions Underlying the Theories

In order to have a clear understanding of these theories and the relationship between capital structure and value of the firm or cost of capital, the following assumptions are made:

- (i) Firms employ only debt and equity.
- (ii) The total assets of the firm are given.
- (iii) The firm's total financing remains constant. The degree of leverage can be changed by selling debt to repurchase shares or selling shares to retire debt.
- (iv) The firm has 100% payout ratio, i.e., it pays 100% of its earnings as dividends.
- (v) The operating earnings (EBIT) of the firm are not expected to grow.
- (vi) The business risk is assumed to be constant and independent of capital structure and financial risk.
- (vii) Investors have the same subjective probability distribution of expected future operating earnings for a given firm.
- (viii) There are no corporate and personal taxes. This assumption is relaxed later.

In analysing the capital structure theories the following basic definitions are used:

S = Market value of common shares

D = Market value of debt

V = S + D = Market value of the firm

### Cost of Capital & Capital Structure

NOI = X = Expected net operating income, i.e., Earnings before interest and taxes (EBIT)

NI = NOI - Interest = Net Income or shareholders earning.

#### 1. Net Income Approach

This approach was identified by David Durand. According to this approach, capital structure has relevance, and a firm can increase the value of the firm and minimise the overall cost of capital by employing debt capital in its capital structure. According to this theory, greater the debt capital employed, lower shall be the overall cost of capital and more shall be the value of the firm.

This theory is subject to the following assumptions:

- (i) The cost of debt is less than cost of equity.
- (ii) The risk perception of investors is not affected by the use of debt. As a result, the equity capitalisation rate ( $k_e$ ) and the debt - capitalisation rate ( $k_d$ ) don't change with leverage.
- (iii) There are no corporate taxes.

According to the above assumptions, cost of debt is cheaper than cost of equity and they remain constant irrespective of the degree of leverage. If more debt capital is used because of its relative cheapness, the overall cost of capital declines and the value of the firm increases.



According to this approach:

$$V = S + D$$

$$S = \text{market value of equity} = \frac{NI}{K_e}$$

$$K_o \text{ Overall cost of Capital} = \frac{EBIT}{V}$$

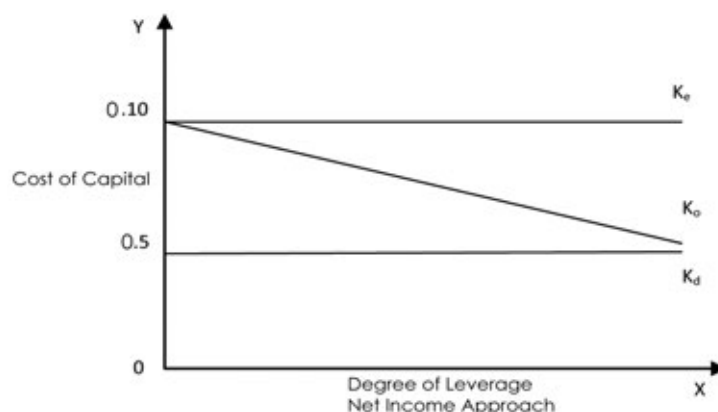

It is evident from the above diagram that when degree of leverage is zero (i.e. no debt capital employed), overall cost of capital is equal to cost of equity ( $K_o = K_e$ ). If debt capital is employed further and further which is relatively cheap when compared to cost of equity, the overall cost of capital declines, and it becomes equal to cost of debt ( $k_d$ ) when leverage is one (i.e. the firm is fully debt financed). Thus, according to this theory, the firm's capital structure will be optimum, when degree of leverage is one.

### Illustration 22

EBIT of PHI India Ltd. is ₹5,00,000. The company has 10%, 20 lakh debentures. The equity capitalisation rate i. e.  $K_e$  is 16%. You are required to calculate:

- Market value of equity and value of the company
- Overall cost of capital

**Solution:**

#### (a) Statement showing the value of the company

	₹
EBIT	5,00,000
Less: Interest on debentures (10% of ₹20,00,000)	(2,00,000)
Earnings available for equity holder i.e. Net Income (NI)	3,00,000
Equity capitalisation rate ( $K_e$ )	16%
Market value of equity (S) = $\frac{NI}{K_e} = \left( \frac{3,00,000}{16.00} \times 100 \right)$	18,75,000
Market value of debt (D)	20,00,000
Total value of the company (V) = S + D	38,75,000



$$(b) \text{ Overall cost of capital} = \frac{\text{EBIT}}{\text{Value of the company}} = \frac{5,00,000}{38,75,000} = 12.90\%$$

## 2. Net Operating Income Approach

This net operating income (NOI) approach is also suggested by David Durand. This represents another extreme view that capital structure and value of the firm are irrelevant. This capital structure of the firm does not influence cost of capital and value of the firm. The value of the firm (V) is determined as follows:

$$V = S + D = \frac{\text{NOI}}{K_o}$$

$K_o$  The overall cost of capital and depends on the business risk of the firm. It is not affected by financing mix.

The critical assumptions of this theory are:

1. The market capitalises the value of the firm as a whole. Thus, the split between debt and equity is not important.
2. The business risk remains constant at every level of debt - equity mix.
3. There are no corporate taxes.
4. The debt capitalisation rate ( $K_d$ ) is constant.

According to this theory, the use of less costly debt increases the risk to equity shareholders. This causes the equity capitalisation rate ( $K_e$ ) to increase. As a result, the low cost advantage of debt is exactly offset by the increase in the equity capitalisation rate. Thus, the overall capitalisation rate ( $K_o$ ) remains constant and consequently the value of the firm does not change.

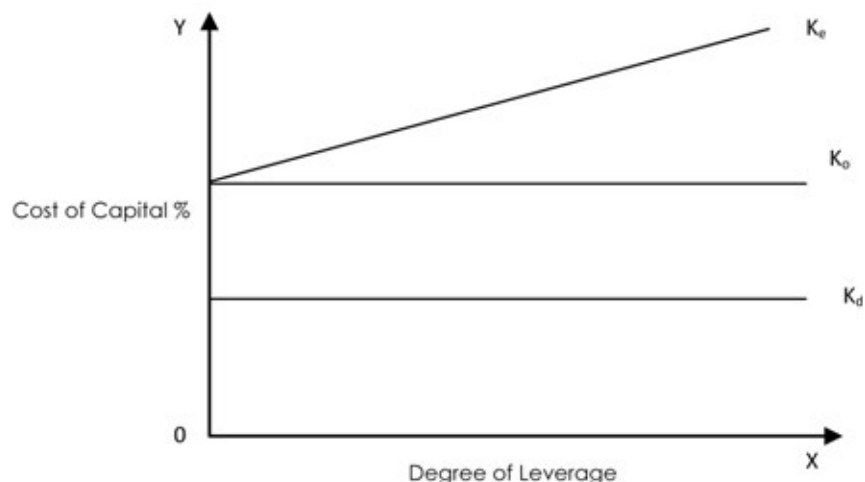

### NOI Approach

The above diagram shows that  $K_o$  and  $K_d$  are constant and  $K_e$  increases with leverage continuously. The increase in cost of equity ( $K_e$ ) exactly offsets the advantage of low cost debt, so that overall cost of capital ( $K_o$ ) remains constant, at every degree of leverage. It implies that every capital structure is optimum and there is no unique optimum capital structure.

**Illustration: 23**

HPL Ltd's operating income is ₹ 5,00,000. The company's cost of debt is 10% and currently the company employs ₹15,00,000 of debt. The overall cost of capital of the company is 15%.

You are required to find out:

- Total value of the company
- Cost of equity.

**Solution:****(a) Statement showing the value of the company**

	₹
Net operating income/EBIT	5,00,000
Less: Interest on debentures (10% of ₹15,00,000)	(1,50,000)
Earnings available for equity holders	3,50,000
Total cost of capital ( $K_o$ ) (given)	15%
Value of the company $V = \frac{\text{EBIT}}{K_o} = \frac{5,00,000}{0.15}$	33,33,333

**(b) Calculation of cost of equity**

	(₹)
Market value of debt (D)	15,00,000
Market value of equity (S) = (V - D) = ₹33,33,333 - ₹15,00,000	18,33,333

$$K_e = \frac{\text{Earnings available for equity holders}}{\text{Value of equity (S)}}$$

$$\text{Or, } = \frac{\text{EBIT} - \text{Interest paid on debt}}{\text{Market value of equity}} = \frac{₹3,50,000}{₹18,33,333} = 19.09\%$$

$$K_o = K_e \left( \frac{S}{V} \right) + K_d \left( \frac{D}{V} \right)$$

$$K_o = K_o \left( \frac{V}{S} \right) - K_d \left( \frac{D}{S} \right)$$

$$= 0.15 \left( \frac{33,33,333}{18,33,333} \right) - 0.10 \left( \frac{15,00,000}{18,33,333} \right)$$

$$= \frac{1}{18,33,333} [(0.15 \times 33,33,333) - 0(0.10 \times 15,00,000)]$$

$$= \frac{1}{18,33,333} [5,00,000 - 1,50,000] = 19.09\%$$





### 3. The Traditional View

This approach, which is also known as intermediate approach, has been popularised by Ezra Solomon. It is a compromise between the two extremes of Net Income Approach and Net Operating Income Approach. According to this approach, cost of capital can be reduced or the value of the firm can be increased with a judicious mix of debt and equity. This theory says that cost of capital declines with increase in debt capital upto a reasonable level, and later it increases with a further rise in debt capital.

The way in which the overall cost of capital reacts to changes in capital structure can be divided into three stages under traditional position.

#### Stage I

In this stage, the cost of equity ( $K_e$ ) and the cost of debt ( $K_d$ ) are constant and cost of debt is less than cost of equity. The employment of debt capital upto a reasonable level will cause the overall cost of capital to decline due to the low cost advantage of debt.

#### Stage II

Once the firm has reached a reasonable level of leverage, a further increase in debt will have no effect on the value of the firm and the cost of capital. This is because of the fact that a further rise in debt capital increases the risk to equity shareholders which leads to a rise in equity capitalisation rate ( $K_e$ ). This rise in cost of equity exactly offsets the low – cost advantage of debt capital so that the overall cost of capital remains constant.

#### Stage III

If the firm increases debt capital further and further beyond reasonable level, it will cause an increase in risk to both equity shareholders and debt – holders, because of which both cost of equity and cost of debt start rising in this stage. This will in turn will cause an increase in overall cost of capital.

If the overall effect of all the three stages is taken, it is evident that cost of capital declines and the value of the firm increases with a rise in debt capital upto a certain reasonable level. If debt capital is further increased beyond this level, the overall cost of capital ( $K_o$ ) tends to rise and as a result the value of the firm will decline.

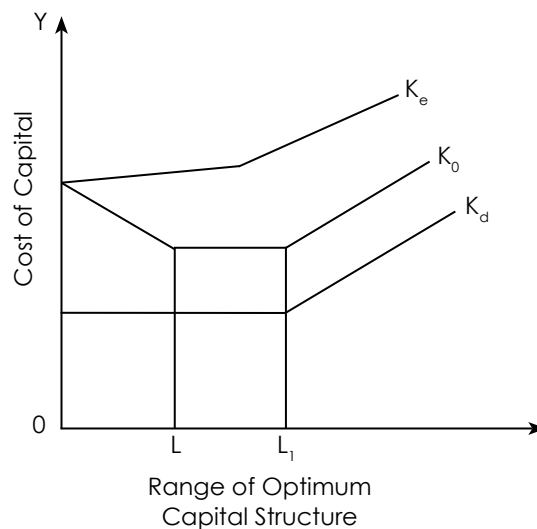

**Traditional View**

It is evident from above graph that the overall cost of capital declines with an increase in leverage upto point L and it increases with rise in the leverage after point L1. Hence, the optimum capital structure lies in between L and L1.

**Illustration: 24**

HUL Ltd. has EBIT of ₹ 1,00,000. The company makes use of debt and equity capital. The company has 10% debentures of ₹ 5,00,000 and the company's equity capitalisation rate is 15%.

You are required to compute:

- Current value of the company
- Overall cost of capital.

**Solution:**

	₹
EBIT	1,00,000
Less: Interest (@10% on ₹5,00,000)	50,000
Earnings available for equity holders	50,000
Equity capitalisation rate i.e. $K_e$	15%

$$\begin{aligned} \text{(a) Value of equity holders} &= \frac{\text{Earnings available for equity holders}}{\text{Value of equity (S)}} \\ &= \frac{\text{₹}50,000}{0.15} = \text{₹}3,33,333 \\ \text{Value of Debt (Given) D} &= \text{₹}5,00,000 \\ \text{Total value of the company } V = D + S &= \text{₹}8,33,333 \end{aligned}$$

$$\begin{aligned} \text{(b) Overall cost of capital} = K_o &= K_e = K_e \left( \frac{S}{V} \right) + K_d \left( \frac{D}{V} \right) \text{ or } \frac{\text{EBIT}}{V} \\ &= 0.15 \left( \frac{3,33,333}{8,33,333} \right) + 0.10 \left( \frac{5,00,000}{8,33,333} \right) \\ &= \frac{1}{8,33,333} [50,000 + 50,000] = 12.00\% \end{aligned}$$

**4. Modigliani – Miller (MM) Hypothesis**

The Modigliani – Miller hypothesis is identical with the Net Operating Income Approach. Modigliani and Miller argued that, in the absence of taxes the cost of capital and the value of the firm are not affected by the changes in capital structure. In other words, capital structure decisions are irrelevant and value of the firm is independent of debt – equity mix.

**Basic Propositions**

M -M Hypothesis can be explained in terms of two propositions of Modigliani and Miller. They are:

- The overall cost of capital ( $K_o$ ) and the value of the firm are independent of the capital structure. The total market value of the firm is given by capitalising the expected net operating income by the rate appropriate for that risk class.



- (ii) The financial risk increases with more debt content in the capital structure. As a result cost of equity ( $K_e$ ) increases in a manner to offset exactly the low – cost advantage of debt. Hence, overall cost of capital remains the same.

**Assumptions of the MM Approach**

1. There is a perfect capital market. Capital markets are perfect when
  - (i) Investors are free to buy and sell securities,
  - (ii) They can borrow funds without restriction at the same terms as the firms do,
  - (iii) They behave rationally,
  - (iv) They are well informed, and
  - (v) There are no transaction costs.
2. Firms can be classified into homogeneous risk classes. All the firms in the same risk class will have the same degree of financial risk.
3. All investors have the same expectation of a firm's net operating income (EBIT).
4. The dividend payout ratio is 100%, which means there are no retained earnings.
5. There are no corporate taxes. This assumption has been removed later.

**Proposition I**

According to M – M, for the firms in the same risk class, the total market value is independent of capital structure and is determined by capitalising net operating income by the rate appropriate to that risk class. Proposition I can be expressed as follows:

$$V = S + D = \frac{X}{K_0} = \frac{NOI}{K_0}$$

Where,

V = The market value of the firm

S = The market value of equity

D = The market value of debt

According the Proposition I the average cost of capital is not affected by degree of leverage and is determined as follows:

$$K_0 = \frac{X}{V}$$

According to M –M, the average cost of capital is constant as shown in the following Figure.

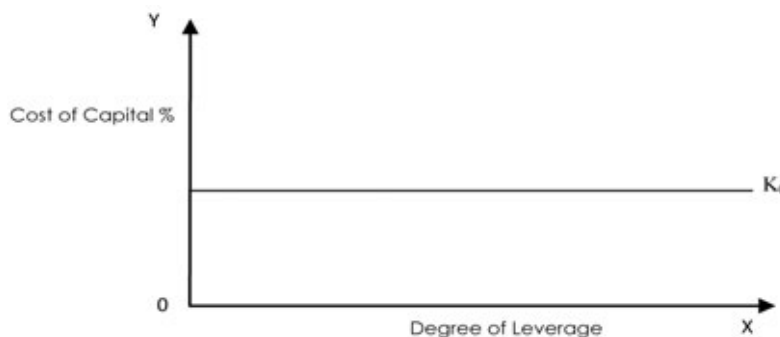

### Arbitrage Process

According to M-M, two firms identical in all respects except their capital structure, cannot have different market values or different cost of capital. In case, these firms have different market values, the arbitrage will take place and equilibrium in market values is restored in no time. Arbitrage process refers to switching of investment from one firm to another. When market values are different, the investors will try to take advantage of it by selling their securities with high market price and buying the securities with low market price. The use of debt by the investors is known as personal leverage or homemade leverage.

Because of this arbitrage process, the market price of securities in higher valued market will come down and the market price of securities in the lower valued market will go up, and this switching process is continued until the equilibrium is established in the market values. So, M -M, argue that there is no possibility of different market values for identical firms.

### Reverse Working of Arbitrage Process

Arbitrage process also works in the reverse direction. Leverage has neither advantage nor disadvantage. If an unlevered firm (with no debt capital) has higher market value than a levered firm (with debt capital) arbitrage process works in reverse direction. Investors will try to switch their investments from unlevered firm to levered firm so that equilibrium is established in no time.

Thus, M - M proved in terms of their proposition I that the value of the firm is not affected by debt-equity mix.

### Proposition II

M - M's proposition II defines cost of equity. According to them, for any firm in a given risk class, the cost of equity is equal to the constant average cost of capital ( $K_0$ ) plus a premium for the financial risk, which is equal to debt - equity ratio times the spread between average cost and cost of debt. Thus, cost of equity is:

$$K_e = K_0 + (K_0 - K_d) \frac{D}{S}$$

Where,  $K_e$  = Cost of equity

$K_0$  = Average cost of capital

$D/S$  = Debt - Equity ratio

$K_d$  = Cost of debt

M - M argue that  $K_0$  will not increase with the increase in the leverage, because the low - cost advantage of debt capital will be exactly offset by the increase in the cost of equity as caused by increased risk to equity shareholders. The crucial part of the M - M Thesis is that an excessive use of leverage will increase the risk to the debt holders which results in an increase in cost of debt ( $K_d$ ). However, this will not lead to a rise in  $K_0$ . M - M maintains that in such a case  $K_e$  will increase at a decreasing rate or even it may decline. This is because of the reason that at an increased leverage, the increased risk will be shared by the debt holders. Hence  $K_0$  remain constant. This is illustrated in the Figure given below:



**M M Hypothesis and Cost of Capital**



### Criticism on MM Hypothesis

The arbitrage process is the behavioural and operational foundation for M M Hypothesis. But this process fails the desired equilibrium because of the following limitations.

- (i) Rates of interest are not the same for the individuals and firms. The firms generally have a higher credit standing because of which they can borrow funds at a lower rate of interest as compared to individuals.
- (ii) Home – Made leverage is not a perfect substitute for corporate leverage. If the firm borrows, the risk to the shareholder is limited to his shareholding in that company. But if he borrows personally, the liability will be extended to his personal property also. Hence, the assumption that personal or home – made leverage is a perfect substitute for corporate leverage is not valid.
- (iii) The assumption that transaction costs do not exist is not valid because these costs are necessarily involved in buying and selling securities.
- (iv) The working of arbitrage is affected by institutional restrictions, because the institutional investors are not allowed to practice home – made leverage.
- (v) The major limitation of M – M hypothesis is the existence of corporate taxes. Since the interest charges are tax deductible, a levered firm will have a lower cost of debt due to tax advantage when taxes exist.

### M – M Hypothesis Corporate Taxes

Modigliani and Miller later recognised the importance of the existence of corporate taxes. Accordingly, they agreed that the value of the firm will increase or the cost of capital will decrease with the use of debt due to tax deductibility of interest charges. Thus, the optimum capital structure can be achieved by maximising debt component in the capital structure.

According to this approach, value of a firm can be calculated as follows:

$$\text{Value of Unlevered firm } (V_u) = \frac{\text{EBIT}}{K_0} (1 - t)$$

Where,

EBIT = Earnings before interest and taxes

$K_0$  = Overall cost of capital

D = Value of debt capital

t = Tax rate.

Value of levered firm (V<sub>L</sub>) = Value of Unlevered firm + Debt (tax rate)

### Trade – off Theory

The trade-off theory of capital structure refers to the idea that a company chooses how much debt finance and how much equity finance to use by balancing the costs and benefits. Tradeoff theory of capital structure basically entails offsetting the costs of debt against the benefits of debt.

Trade-off theory of capital structure primarily deals with the two concepts - cost of financial distress and agency costs. An important purpose of the trade-off theory of capital structure is to explain the fact that companies usually are financed partly with debt and partly with equity.

It states that there is an advantage to financing with debt, the tax benefits of debt and there is a cost of financing with debt, the costs of financial distress including bankruptcy costs of debt and non-bankruptcy costs (e.g. staff leaving, suppliers demanding disadvantageous payment terms, bondholder/stockholder infighting, etc).

The marginal benefit of further increases in debt declines as debt increases, while the marginal cost increases, so that a company that is optimizing its overall value will focus on this trade-off when choosing how much debt and equity to use for financing. Modigliani and Miller in 1963 introduced the tax benefit of debt. Later work led to an optimal capital structure which is given by the trade-off theory. According to Modigliani and Miller, the attractiveness of debt decreases with the personal tax on the interest income. A company experiences financial distress when it is unable to cope with the debt holders' obligations. If the company continues to fail in making payments to the debt holders, it can even be insolvent.

Trade-off theory of capital structure, considered as the cost of debt is usually the financial distress costs or bankruptcy costs of debt. The direct cost of financial distress refers to the cost of insolvency of a company. Once the proceedings of insolvency start, the assets of the firm may be needed to be sold at distress price, which is generally much lower than the current values of the assets. A huge amount of administrative and legal costs is also associated with the insolvency. Even if the company is not insolvent, the financial distress of the company may include a number of indirect costs like - cost of employees, cost of customers, cost of suppliers, cost of investors, cost of managers and cost of shareholders.

The companies may often experience a dispute of interests among the management of the firm, debt holders and shareholders. These disputes generally give birth to agency problems that in turn give rise to the agency costs. The agency costs may affect the capital structure of a company. There may be two types of conflicts - shareholders-managers conflict and shareholders-debt holders conflict. The introduction of a dynamic Tradeoff theory of capital structure makes the predictions of this theory a lot more accurate and reflective of that in practice.

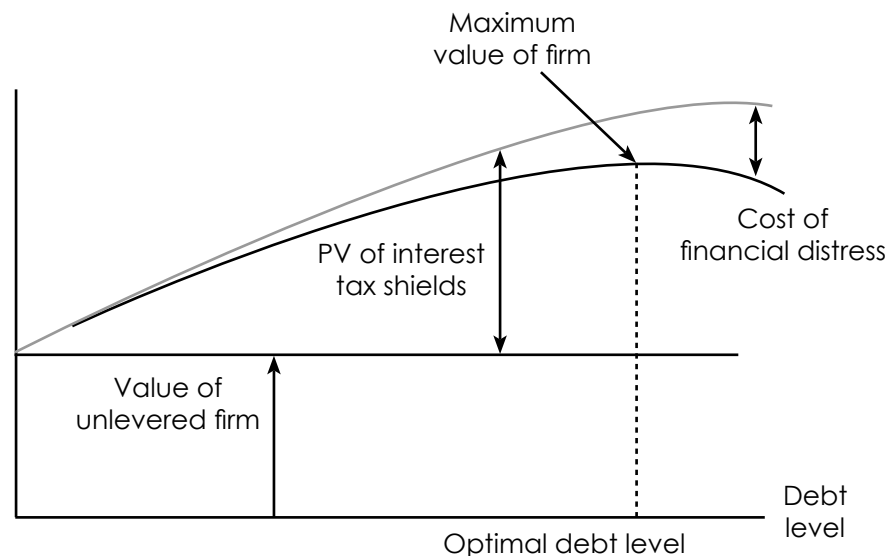

As the Debt-equity ratio (i.e. leverage) increases, there is a trade-off between the interest tax shield and bankruptcy, causing an optimum capital structure,  $D/E^*$

### Pecking Order Theory

This theory is based on Asymmetric information, which refers to a situation in which different parties have different information. In a company, managers will have better information than investors. This theory states that companies prefer to issue debt when they are positive about future earnings. Equity is issued when they are doubtful and internal finance is insufficient.



The pecking order theory argues that the capital structure decision is affected by manager's choice of a source of capital that gives higher priority to sources that reveal the least amount of information.

There are two kind of equity internal and external. Now Debt is cheaper than both internal and external equity because of interest. Further internal equity is less than external equity particularly because of no transaction/issue cost, no tax etc. Pecking order theory suggests that managers may use various sources for raising of fund in the following order.

- a. Managers' first choice is to use internal finance
- b. In absence of internal finance they can use secured debt, unsecured debt, hybrr debt etc.
- c. Managers may issue new equity shares as a last option. Therefore, under this theory rules are:

*Rule 1:* Use internal financing first.

*Rule 2:* Issue debt next

*Rule 3:* Issue of new equity shares at last.

### Illustration: 25

A company's expected annual net operating income (EBIT) is ₹50,000. The company has ₹2,00,000, 10% debentures. The equity capitalisation rate ( $K_e$ ) of the company is 12.5%. Find the value of the firm and overall cost of capital under Net Income approach.

### Solution:

#### Calculation of value of firm and overall cost of capital under Net Income approach

Value of firm = MV of Equity + MV of Debt

EBIT	50,000
Less: Interest (2,00,000 x 10%)	20,000
Equity earnings	30,000
Equity Capitalisation Rate ( $K_e$ )	12.5%

Therefore

Value of Equity = $\frac{30,000}{12.5\%}$	₹ 2,40,000
Value of Debt (given)	₹ 2,00,000
Value of Firm	₹ 4,40,000

#### Overall Cost of Capital ( $K_o$ )

$$K_o = 12.5 \times \left[ \frac{2,40,000}{4,40,000} \right] + 10 \times \left[ \frac{2,00,000}{4,40,000} \right]$$

$$K_o = 11.36\%$$

**Illustration: 26**

Assuming no taxes and given the earnings before interest and taxes (EBIT), interest (I) at 10% and equity capitalisation rate ( $K_e$ ) below, calculate the total market value of each firm under Net Income Approach:

Firms	EBIT (₹)	I (₹)	K
X	2,00,000	20,000	12.0%
Y	3,00,000	60,000	16.0%
Z	5,00,000	2,00,000	15.0%
W	6,00,000	2,40,000	18.0%

Also determine the weight average cost of capital for each firm.

**Solution:**

Calculation of valuation of each firm under Net Income Approach

Value of firm = Value of equity + Value of debt

FIRM	X (₹)	Y (₹)	Z (₹)	W (₹)
EBIT	2,00,000	3,00,000	5,00,000	6,00,000
Less: Interest	20,000	60,000	2,00,000	2,40,000
Equity Earnings	1,80,000	2,40,000	3,00,000	3,60,000
Cost of Equity ( $K_e$ )	12%	16%	15%	18%
Capitalised value of equity	15,00,000	15,00,000	20,00,000	20,00,000
Add: MV of Debt	2,00,000	6,00,000	20,00,000	24,00,000
Value of firm	17,00,000	21,00,000	40,00,000	44,00,000
WACC ( $K_o$ )	11.76%	14.19%	12.50%	13.64%

Note 1: Value of debt =  $\frac{\text{Interest}}{K_d}$

Note 2:  $K_o = \frac{\text{EBIT}}{\text{Value of firm}}$

**Illustration: 27**

The existing capital structure of XYZ Ltd. is as under:

	₹
Equity Shares of ₹ 100 each	40,00,000
Retained Earnings	10,00,000
9% Preference Shares	25,00,000
7% Debentures	25,00,000

The existing rate of return on the company's capital is 12% and the income-tax rate is 50%.





The company requires a sum 25,00,000 to finance an expansion programme for which it is considering the following alternatives:

- (i) Issue of 20,000 equity shares at a premium of `25 per share.
- (ii) Issue of 10% preference shares.
- (iii) Issue of 8% debentures

It is estimated that the PE ratios in the cases of equity preference and debenture financing would be 20, 17 and 16 respectively.

Which of the above alternatives would you consider to be the best?

**Solution:**

**Evaluation of various financial alternatives**

(₹)

	Plan I (Equity)	Plan II (Preference Shares)	Plan III (Debentures)
1. EBIT	15,00,000	15,00,000	15,00,000
2. Interest:			
Existing	1,75,000	1,75,000	1,75,000
Additional	-	-	2,00,000
Total Interest	1,75,000	1,75,000	3,75,000
3. PBT (1-2)	13,25,000	13,25,000	11,25,000
4. TAX 50%	6,62,500	6,62,500	5,62,500
5. PAT (3-4)	6,62,500	6,62,500	5,62,500
6. Preference dividend			
Existing	2,25,000	2,25,000	2,25,000
Additional	-	2,50,000	-
Total Preference Dividend	2,25,000	4,75,000	2,25,000
7. Equity earnings (5-6)	4,37,500	1,87,500	3,37,500
8. No. of equity shares	*60,000	40,000	40,000
9. EPS $\left[\frac{7}{8}\right]$	7.29	4.69	8.44
10. P/E Ratio (Given)	20	17	16
11. Market Price per share	145.80	79.73	135.04

\* Note 1: No. of shares under Plan I

Existing shares	40,000
Additional shares	20,000
Total shares	60,000

**Illustration: 28**

XL Limited provides you with following figures:

	(₹)
Profit	2,60,000
Less: Interest on Debentures @ 12%	60,000
	2,00,000
Income tax @ 50%	1,00,000
Profit after tax	1,00,000
Number of Equity shares (of ₹10 each)	40,000
EPS (Earning per share)	2.50
Ruling price in market	25
PE Ratio (i.e. Price/EPS)	10

The Company has undistributed reserves of ₹6,00,000. The company needs ₹2,00,000 for expansion. This amount will earn at the same rate as funds already employed. You are informed that a debt equity ratio Debt/ (Debt+ Equity) more than 35% will push the P/E Ratio down to 8 and raise the interest rate on additional amount borrowed to 14%. You are required to ascertain the probable price of the share.

- If the additional funds are raised as debt; and
- If the amount is raised by issuing equity shares.

**Solution:****Computation of existing capital and return on capital employed** ₹

Equity share Capital	40,000 x 10	4,00,000
12% debentures	$\frac{60,000}{12\%}$	5,00,000
Undistributed Reserves		6,00,000
Existing Capital		15,00,000
Return on Capital employed	$\frac{2,60,000}{15,00,000} \times 100$	= 17.33%

**Calculation of Debt Equity Ratio**

	Plan I (Debt Plan)	Plan II (Equity Plan)
Existing Equity (Capital + Reserve)	10,00,000	10,00,000
Additional equity	-	2,00,000
Total equity (A)	10,00,000	12,00,000
Existing Debt	5,00,000	5,00,000
Additional Debt	2,00,000	-
Total Debt (B)	7,00,000	5,00,000
Debt Equity Ratio $\frac{\text{Debt}}{\text{Debt} + \text{Equity}}$	$\frac{7,00,000}{15,00,000} \times 100$	$\frac{5,00,000}{5,00,000 + 12,00,000}$
	= 41.18%	= 29.41%
Applicable P/E Ratio	8	10



**Computation of probable market price of share after expansion**

₹

	Plan I (Debt)	Plan II (Equity)
1. EBIT (17,00,000 x 17.33%)	2,94,610	2,94,610
2. Interest (Existing + Additional)	88,000	60,000
3. PBT (1-2)	2,06,610	2,34,610
4. Tax @ 50%	1,03,305	1,17,305
5. PAT (3-4)	1,03,305	1,17,305
6. Preference Dividend	-	-
7. Equity Earnings (5-6)	1,03,305	1,17,305
8. No. of equity shares (Existing + Additional)	40,000	*48,000
9. EPS (= 7/8)	2.58	2.44
10. P/E Ratio	8	10
11. Market Price [= EPS × P/E Ratio]	20.64	24.40

The Market Price is higher at Plan II. So, the company has to adopt Plan II i.e., raising additional funds by issuing equity shares preferable.

\***Note:** Additional equity issued at prevailing market price i.e., ₹ 25

**Illustration: 29**

From the following data find out the value of each firm and value of each equity share as per the Modigliani-Miller approach:

	P	Q	R
EBIT	13,00,000	13,00,000	13,00,000
No. of shares	3,00,000	2,50,000	2,00,000
12% debentures		9,00,000	10,00,000

Every firm expect 12% return on investment.

**Solution:**

**Calculation of value of each firm under Modigliani – Miller approach**

$$\text{Value of firm} = \frac{\text{EBIT}}{K_0}$$

Firm	P	Q	R
1. EBIT	13,00,000	13,00,000	13,00,000
2. ROI = $K_0$	12%	12%	12%
3. Value of Firm $\left[ \frac{1}{2} \right]$	1,08,33,333	1,08,33,333	1,08,33,333

**Calculation of value of each equity share for each firm**

Firm	P	Q	R
1. Value of Firm	1,08,33,333	1,08,33,333	1,08,33,333
2. Debt	-	9,00,000	10,00,000
3. Value of equity (1-2)	1,08,33,333	99,33,333	98,33,333
4. No. of equity shares	3,00,000	2,50,000	2,00,000
5. Market Price $\left[\frac{3}{4}\right]$	36.11	39.73	49.17

**Illustration: 30**

Z Co. has a capital structure of 30% debt and 70% equity. The company is considering various investment proposals costing less than ₹ 30 Lakhs. The company does not want to disturb its present capital structure. The cost of raising the debt and equity are as follows:

Project Cost	Cost of Debt	Cost of Equity
Above ₹ 5 Lakhs	9%	13%
Above ₹ 5 Lakhs and upto ₹ 20 Lakhs	10%	14%
Above ₹ 20 Lakhs and upto ₹ 40 Lakhs	11%	15%
Above ₹ 40 Lakhs and upto ₹ 1 Crore	12%	15.55%

Assuming the tax rate is 50%, compute the cost of two projects A and B, whose fund requirements are ₹ 8 Lakhs and ₹ 22 Lakhs respectively. If the project are expected to yield after tax return of 11%, determine under what conditions it would be acceptable.

**Solution:**

Capital Structure: (given) = 30% Debt and 70% Equity

**Calculation of overall cost of capital at different investment outlays**

Project Cost	$K_d (1-t)$	$K_e$	$K_o = W_d K_d + K_e W_e$
Upto ₹ 5 lakhs	9% (1-0.5)=4.5%	13%	$(0.3 \times 4.5) + (0.7 \times 13) = 10.450\%$
₹ 5 lakhs to 20 lakhs	10% (1-0.5)= 5%	14%	$(0.3 \times 5) + (0.7 \times 14) = 11.300\%$
₹ 20 lakhs to 40 lakhs	11% (1-0.5)= 5.5%	15%	$(0.3 \times 5.5) + (0.7 \times 15) = 12.150\%$
₹ 40 lakhs to 1 crore	12% (1-0.5)= 6%	15.55%	$(0.3 \times 6) + (0.7 \times 15.55) = 12.685\%$

**Evaluation of given projects**

Project	Investment	$K_o$	Project Return	Result
A	8 lakhs	11.3%	11%	Return $< K_o$
B	22 lakhs	12.15%	11%	Return $< K_o$

**Comment:** Both the projects, A and B, are not acceptable as the Cost of Capital is more than the Expected yield of the project. In order to accept the project the Expected return should always be greater than the cost of capital.

**Illustration: 31**

Company X and Company Y are in the same risk class, and are identical in every fashion except that Company X uses debt while Company Y does not. The levered firm has ₹ 9,00,000 debentures, carrying 10% rate of interest. Both the firms earn 20% before interest and taxes on their total assets of ₹15 lakhs. Assume perfect capital markets, rational investors and so on; a tax rate of 50% and capitalisation rate of 15% for an all equity company.

- (i) Compute the value of firms X and Y using the net income (NI) approach.
- (ii) Compute the value of each firm using the net operating income (NOI) approach.
- (iii) Using the NOI approach, calculate the overall cost of capital ( $k_o$ ) for firms X and Y.
- (iv) Which of these two firms has an optimal capital structure according to the NOI approach? Why?

**Solution:**
**(i) Computation of value of firms X and Y using NI approach**

NI approach assumes no taxes. Since, the tax rate is given in the problem, we have to work out of NI approach.

Value of Firm = MV of Equity + MV of Debt ₹

	X	Y
EBIT	3,00,000	3,00,000
Less: Interest	90,000	-
PBT	2,10,000	3,00,000
Less: Tax @ 50%	1,05,000	1,50,000
PAT	1,05,000	1,50,000
$K_e$	15%	15%
Capitalised Value of equity	7,00,000	10,00,000
MV of Debt	9,00,000	-
value of firm	16,00,000	10,00,000

**(ii) Computation of value of firms X and Y using NOI approach**

Net operating Income approach assumes no taxes. Since the tax rate is given in the problem, we have to work out using MM approach, which is an extension of NOI approach.

$$\text{Value of unlevered firm (Y)} = \frac{\text{EBIT}(1-t)}{K_e} = \frac{3,00,000(1-0.05)}{0.15} = ₹ 10,00,000$$

$$\begin{aligned} \text{Value of levered firm (X)} &= \text{Value of unlevered firm} + \text{Debt (Tax rate)} \\ &= \text{Value of Y Ltd} + \text{Debt (Tax rate)} \\ &= 10,00,000 + (9,00,000 \times 50\%) \\ &= ₹ 14,50,000 \end{aligned}$$

**(iii) Computation of overall cost of capital ( $K_o$ ) using NOI approach**

For Y Ltd:

$$K_o = K_e = 15\% \text{ (as there is no debt)}$$



For X Ltd: ₹

Value of firm	14,50,000
Less: Value of debt	9,00,000
Market value of equity	5,50,000

$$K_e = \frac{\text{Equity Earning}}{\text{Market Value of Equity}} \times 100 = \frac{1,05,000}{5,50,000} \times 100 = 19\%$$

$$K_d = 0.10 (1-0.50) = 5\%$$

$$K_o = 19 \times \frac{5,50,000}{14,50,000} + 5 \times \frac{9,00,000}{14,50,000} = 10.31\%$$

**Comment:** Out of two firms Firm Y seems to have optimum capital structure as it has lower cost of capital higher value of firm.

### Illustration: 32

A Company's current operating income is ₹4 lakhs. The firm has ₹10 lakhs of 10% debt outstanding. Its cost of equity capital is estimated to be 15%.

- Determine the current value of the firm using traditional valuation approach.
- Calculate the firm's overall capitalisation ratio as well as both types of leverage ratios (a) B/s (b) B/V.

### Solution:

#### (i) Calculation of value of firm (Vf) under Traditional approach

Value of firm = Value of Debt + Value of equity

1. EBIT	4,00,000
2. Interest (10,00,000 x 10%)	1,00,000
3. Equity Earnings (1-2)	3,00,000
4. Equity Capitalisation rate	15%
5. Value of Equity $\left[ \frac{3}{4} \right]$	20,00,000
6. Value of Debt	10,00,000
7. Value of firm(5+6)	30,00,000

#### (ii) Calculation overall capitalization rate and leverage ratios

$$\text{Overall Capital Rate } (K_o) = \frac{\text{EBIT}}{\text{Value of firm}} \times 100 = \frac{4,00,000}{30,00,000} \times 100 = 13.33\%$$



### Leverage Ratios

$$a) \text{ B/S Ratio} = \frac{\text{Borrowing}}{\text{Share Holders Funds}} = \frac{10,00,000}{20,00,000} = 0.5$$

$$b) \text{ B/V Ratio} = \frac{\text{Borrowing}}{\text{Share Holders Funds}} = \frac{10,00,000}{30,00,000} = 0.33$$

## 9.3 DIVIDEND POLICY

### Introduction:

Dividends are a major cash outlay for many corporations. At first glance it would appear that a company could distribute as much as possible to please its shareholders. It might seem equally obvious that a firm could invest money for its shareholders instead of paying dividends.

A firm's decisions about dividends are often mixed up with other financing and investment decisions. Some firms pay low dividends because management is optimistic about a firm's future and wishes to retain earnings for expansion. Another firm might finance capital expenditures largely by borrowing. This releases cash for dividends.

The firm's dividend policy must be isolated from other problems of financial management. The dividend policy is a trade-off between retained earnings on the one hand and paying out cash and issuing shares on the other.

There are many firms that pay dividends and also issue stock from time to time. They could avoid the stock issues (where costs are highest for the firm) by paying lower dividends. Many other firms restrict dividends so that they do not have to issue shares. They on the other hand could occasionally issue stock and increase dividends. Thus both firms face dividend policy trade-off.

There are many reasons for paying dividends and there are many reasons for not paying any dividends.

As a result, dividend policy is always controversial.

### What are dividends? What are the various types?

Dividend is the distribution of profit among shareholders usually expressed as a percentage of paid up capital or as an amount per share.

The term dividend usually refers to a cash distribution of earnings. If it comes from other sources, it is called a liquidating dividend. It mainly has the following types:

- (i) Regular dividends are those the company expects to maintain, paid half-yearly (sometimes monthly, quarterly or annually).
- (ii) Extra dividends are those that may not be repeated.
- (iii) Special dividends are those that are unlikely to be repeated.
- (iv) Stock dividends are sometimes paid in shares of stocks. Similar to stock splits, both increase the number of shares outstanding and reduce the stock price.

### Why a dividend policy is important?

The dividend policy of a company determines what proportion of earnings is distributed to the shareholders by way of dividends, and what proportion is ploughed back for reinvestment purposes. Since the main objective of financial management is to maximize the market value of equity shares, one key area of study is the relationship between the dividend policy and market price of equity shares. In this regard dividend policy assumes significance.



### Significance of Dividend Policy

Dividend policy of a company is governed by:

- (a) Long Term Financing Decision; and
- (b) Wealth Maximisation Decision

#### (a) Long Term Financing Decision

One of the financing option is 'Equity'. Equity can be raised externally through issue of equity shares or can be generated internally through retained earnings. But retained earnings are preferable because they do not involve floatation costs. But whether to retain or distribute the profits forms the basis of this decision. Since payment of cash dividend reduces the amount of funds necessary to finance profitable investment opportunities thereby restricting it to find other avenues of finance.

Under this head, the decision is based on the following:

- (i) Whether the organization has opportunities in hand to invest the amount of profits, if retained?
- (ii) Whether the return on such investment (ROI) will be higher than the expectations of shareholders i.e.  $K_e$ .

#### (b) Wealth Maximisation Decision

Here we face the problem of amount of dividend to be distributed i.e. the Dividend Payout ratio (D/P) in relation to Market price of the shares (MPS). Due to market imperfections and uncertainty, shareholders give higher value to near dividends than future dividends and capital gains. Payment of dividends influences the market price of the share. Higher dividends increase value of shares and low dividends decrease it. A proper balance has to be made between the two approaches. When the firm increases retained earnings, shareholders' dividends decrease and consequently market price is affected. Use of retained earnings to finance profitable investments increases future earnings per share. On the other hand, increase in dividends may cause the firm to forego investment opportunities due to paucity of funds and thereby decrease the future earnings per share.

Therefore management should develop a dividend policy that divides net earnings into dividends and retained earnings in an optimum way so as to achieve the objective of wealth maximisation for shareholders. Such policy will be influenced by investment opportunities available to the company and value of dividends as against capital gains to shareholders.

### Types of Dividend

Generally, the dividend can take any of the following forms:

- (a) Cash dividend; and
- (b) Stock dividend

#### (a) Cash dividend

Cash dividend is the most common form of dividend. Cash here means cash, cheque, warrant, demand draft, pay order or directly through Electronic Clearing Service (ECS) but not in kind.

#### (b) Stock dividend (Bonus Shares)

Stock dividend is distribution of shares in lieu of cash dividend to existing shareholders. When the company issues further shares to its existing shareholders without consideration it is called bonus shares. Such shares are distributed proportionately thereby retaining proportionate ownership of the company.





There are many **advantages** of both to the shareholders and to the company some of which are mentioned below:

**To Shareholders:** (a) Tax benefit -At present there is no tax on dividend received; (b) Policy of paying fixed dividend per share and its continuation even after declaration of stock dividend increase total cash dividend of the shareholders in future.

**To Company:** (a) Conservation of cash for meeting profitable investment opportunities; (b) Cash deficiency and restrictions imposed by lenders to pay cash dividend.

There are however, certain **limitations** of stock dividend as discussed below.

**To Shareholders:** Stock dividend does not affect the wealth of shareholders and therefore it has no value for them. This is because the declaration of stock dividend is a method of capitalising the past earnings of the shareholders and is a formal way of recognising earnings which the shareholders already own. It merely divides the company's ownership into a large number of share certificates. Stock dividend does not give any extra or special benefit to the shareholders. Their proportionate ownership in the company does not change at all. Stock dividend creates a favourable psychological impact on the shareholders and is greeted by them on the ground that it gives an indication of the company's growth.

**To Company:** Stock dividends are more costly to administer than cash dividend. It is disadvantageous if periodic small stock dividends are declared by the company as earnings. This results in the measured growth in earnings per share being less than the growth based on per share for small issues of stock dividends are not adjusted at all and only significant stock dividends are adjusted. Moreover, companies have to pay tax on distribution.

## DIVIDEND MODELS

### Graham & Dodd Model (Traditional model)

According to this model founded by Graham and Dodd, the market price of the shares will increase when a company declares a dividend rather than when it does not. Base of their arguments was that investors are rational and under conditions of uncertainty they turn risk averse. In this model weight attached to dividends is four times of weight attached to retained earnings.

Quantitatively

$$p = m(D + \frac{A}{Q})$$

Where:

p is the market price per share

m is a multiplier

D is the dividend per share

E is the earning per share

Critics argue that Graham and Dodd provided weight subjectively and did not derive them from any empirical analysis.

### Walter model

According to this model founded by Jame Walter, the dividend policy of a company has an impact on the share valuation, i.e., dividends are relevant. The key argument is support of the relevance proposition of Walter's model is the relationship between the return on a firm's investment (its internal rate of return) 'r' and its cost of capital (i.e. the required rate of return) 'k'. If the return on investments exceeds the cost of capital, the firm should retain the earnings, whereas it should distribute the earnings to the shareholders in cash the required rate of return exceeds the expected return on the firm's



investments. The rationale is that if  $r > k$ , the firm is able to earn more than what the shareholders could by reinvesting, if the earnings are paid to them. The implication of  $r < k$  is that shareholders can earn a higher return by reinvesting elsewhere.

Quantitatively

$$P = \frac{D + \frac{r}{k}(E - D)}{k}$$

Where:

P is the market price per share

D is the dividend per share

E is the earning per share

r is the internal rate of return on the investments and

k is the cost of capital.

#### Assumptions:

- All financing is done through retained earnings; external sources of funds like debt or new equity capital are not used.
- With addition investments undertaken, the firm's business risk does not change. It implies that 'r' and 'k' are constant.
- There is no change in the key variable namely EPS & DPS. The values D and E may be changed in the model to determine results, but, any given value of E and D are assumed to remain constant in determining a given value.
- The firm has a perpetual (very long) life.

The impact of dividend payment on the share price is studied by comparing the rate of return with the cost of capital.

- When  $r > k$ , the price per share increases as the payout ratio decreases (optimal payout ratio is nil)
- When  $r = k$ , the price per share does not vary with the changes in the payout ratio (optimal payout ratio does not exist)
- When  $r < k$ , the price per share increases as the payout ratio increases (optimal payout ratio is 100%)

#### Gordon model

According to this model founded by Myron Gordon, the dividend policy of the company has an impact on share valuation i.e. dividends are relevant. Myron J Gordon (1962) said that "... investors prefer the early resolution of uncertainty and are willing to pay a higher price of the shares that offer the greater current dividends." Gordon suggested (i) The higher the earnings retention rate, the greater the required future return from investments to compensate for risk. (ii) the risk attitude of investors will ensure that r will rise for each successive year in the future to reflect growth uncertainty.

This is based on the following assumptions:

- The firm is an all equity firm. No external financing is used and only retained earnings finance investments programs.
- 'r' & 'k' are constant.
- The firm has perpetual life.



(d) The retention ratio, once decided upon is constant. Thus the growth rate, ( $g = br$ ) is also constant.

(e)  $K > br$

### Quantitatively

$$P_0 = D1 / K_e - g$$

Where:

P is the price per share

D1 is the Expected Dividend Per Share

$K_e$ : Cost of Equity

G: Growth Rate

Growth Rate: Retention Ratio  $\times$  ROI

On comparing  $r$  and  $k$ , the relationship between market price and the payout ratio is exactly the same as compared to the Walter model. The crux of Gordon's arguments is a two-fold assumption: (i) investors are risk averse, and (ii) they put a premium on a certain return and discount/penalize uncertain returns. In other words the rational investors prefer current dividend. A company which retains earnings is perceived as risky as the future payment of dividend amount and timing is uncertain. Thus they would discount future dividends, that is, they would place less importance on it as compared to current dividend. The above argument underlying Gordon's model of dividend relevance is also described as a bird-in-hand argument. i.e. what is available at present is preferable to what may be available in the future. Gordon argues the more distant the future is, the more uncertain it is likely to be.

### MM model [Dividend Irrelevancy Model]

According to this model, as founded by Miller and Modigliani, the market price of the share does not depend on the dividend payout, i.e. the dividend policy is irrelevant. This model explains the irrelevance of the dividend policy in the following manner.

When profits are used to declare dividends, the market price increases. But at the same time there is a fall in the reserves for reinvestment. Hence for expansion, the company raises additional capital by issuing new shares. Increase in the overall number of shares, will lead to a fall in the market price per share. Hence the shareholders would be indifferent towards the dividend policy.

According to the MM Model the market price of a share after dividend declared is calculated by applying the following formula:

$$P_0 = \frac{D1}{K_e - g}$$

where,

$P_0$  is the prevailing market price

$k_e$  is the cost of equity capital

D1 is the dividend to be received at the end of period one

The number of shares to be issued for new projects, in lieu of dividend payments is given by the following formula:

$$m = \frac{I - (E - nD_1)}{P_1}$$

$n$  – is the number of shares outstanding at the beginning of the period.

$m$  – is no. of new shares issued



I – Total investment amount required for the new project

E – Earnings of net income of the firm during the period

**Proof:**

Let  $n$  represent the original number of outstanding shares of the company,  $D$  be the dividend distributed to the ' $n$ ' shareholders,  $I$  be the total investment amount required for the new project, and  $E$  be the Earnings (net income) of the firm during the period. And let  $m$  represent the number of new shares issued to meet the shortfall in investment issued at a current market price of  $P_1$ .

According to the MM Model the market price of a share after dividend declared is calculated by applying the following formula:

$$P_0 = \frac{P_1 + D_1}{1+k}$$

The current market capitalization is given by

$$nP_0 = \frac{nP_1 + nD_1}{1+k}$$

Adding and subtracting  $mP_1$  on numerator in the RHS of the equation we have,

$$nP_0 = \frac{(m+n)P_1 + nD_1 - mP_1}{1+k}$$

Now,  $mP_1 = \text{Amount raised} = \text{Investment} - [\text{Earnings} - \text{Dividends distributed}] = I - [E - nD_1]$

Substituting in the above equation, we have

$$nP_0 = \frac{(m+n)P_1 + E - I}{1+k}$$

As no dividend term appear on the right hand side of the equation, it is proved that dividends are irrelevant.

**Assumptions & Criticisms or M-M Model**

The critics of the MM model argue that the assumptions underlying the model are unrealistic and vulnerable and have disputed the validity of dividend irrelevance.

**Residual model**

If a firm wishes to avoid issue of shares, then it will have to rely on internally generated funds to finance new positive NPV projects. Dividends can only be paid out of what is left over. This leftover is called a residual and such a dividend policy is called residual dividend approach.

When we treat dividend policy as strictly a financing decision, the payment of cash dividends is a passive residual. The amount of dividend pay-out will fluctuate from period to period in keeping with fluctuations in the number of acceptable investment opportunities available to the firm. If these opportunities abound, the percentage of dividend payout is likely to be zero. On the other hand if the firm is unable to find profitable investment opportunities, dividend payout will be 100%.

With a residual dividend policy, the firm's objective is to meet its investment needs and mostly to maintain its desired debt equity ratio before paying dividends. To illustrate imagine that a firm has ₹ 1000 in earnings and a debt equity ratio of 0.5. Thus the firm has 0.5 of debt for every 1.5 of the total value. The firm's capital structure is 1/3 of debt and 2/3 of equity.



The first step in implementing a residual dividend policy is to determine the amount of funds that can be generated without selling new equity. If the firm reinvests the entire ₹ 1000 and pays no dividend, then equity will increase by ₹ 1000. To keep the debt equity ratio constant, the firm must borrow ₹ 500.

The second step is to decide whether or not the dividend will be paid. If funds needed are less than the funds generated then a dividend will be paid. The amount of dividend will be the residual after meeting investment needs. Suppose we require ₹ 900 for a project. Then 1/3 will be contributed by debt (i.e. ₹ 300) and the balance by equity/retained earnings. Thus the firm would borrow ₹ 300 and fund ₹ 600 from the retained earnings. The residual i.e. ₹ 1000 – ₹ 600 = ₹ 400 would be distributed as dividend.

More clarity can be had from the data given below:

New Investment	Debt portion	Retained	Additional Earnings	Dividends Equity	
1000	3000	1000	1000	1000	0
1000	2000	667	1000	333	0
1000	1500	500	1000	0	0
1000	1000	333	667	0	333
1000	500	167	333	0	667
1000	0	0	0	0	1000

### Dividend Discount Model

Dividend Discount Model is a model which calculates the value of an equity share as the present value of future dividends expected from it.

The dividend discount model is a more conservative variation of discounted cash flows that says a share of stock is worth the present value of its future dividends, rather than its earnings. This model was popularized by John Burr Williams in **The Theory of Investment Value**.

... a stock is worth the present value of all the dividends ever to be paid upon it, no more, no less... Present earnings, outlook, financial condition, and capitalization should bear upon the price of a stock only as they assist buyers and sellers in estimating future dividends.

The dividend discount model can be applied effectively only when a company is already distributing a significant amount of earnings as dividends. But in theory it applies to all cases, since even retained earnings should eventually turn into dividends. That's because once a company reaches its "mature" stage it won't need to reinvest in its growth, so management can begin distributing cash to the shareholders. As Williams puts it.

If earnings not paid out in dividends are all successfully reinvested... then these earnings should produce dividends later; if not, then they are money lost... In short, a stock is worth only what you can get out of it.

The dividend discount model (DDM) is a widely accepted stock valuation tool found in most introductory finance and investment textbooks. The model calculates the present value of the future dividends that a company is expected to pay to its shareholders. It is particularly useful because it allows investors to determine an absolute or "intrinsic" value of a particular company that is not influenced by current stock market conditions. The DDM is also useful because the measurement of future dividends (as opposed to earnings for example) facilitates an "apples-to-apples" comparison of companies across different industries by focusing on the actual cash investors can expect to receive.



There are three alternative dividend discount models used to determine the intrinsic value of a share of stock:

- the constant (or no-growth) dividend model;
- the constant growth dividend model; and
- the two-stage (or two-phase) dividend growth model.

Constant dividends:

$$P = D_1 / K_e \quad \text{where : } P = \text{intrinsic value}$$

$$D_1 = \text{expected dividend}$$

$$k_e = \text{appropriate discount factor for the investment}$$

This method is useful for analyzing preferred shares where the dividend is fixed. However, the constant dividend model is limited in that it does not allow for future growth in the dividend payments for growth industries. As a result the constant growth dividend model may be more useful in examining a firm.

Constant dividend growth:

$$P = D_1 / (K_e - g) \quad \text{where : } P = \text{intrinsic value}$$

$$D = \text{expected dividend 1}$$

$$k = \text{appropriate discount factor for the investment}$$

$$g = \text{constant dividend growth rate}$$

The constant dividend growth model is useful for mature industries, where the dividend growth is likely to be steady. Most mature blue chip stocks may be analyzed quickly with the constant dividend growth model. This model has its limitations when considering a firm which is in its growth phase and will move into a mature phase at some time the future. A two stage growth dividend model may be utilized in such situations. This model allows for adjustment to the assumptions of timing and magnitude of the growth of the firm.

For initial dividend growth & then steady growth:

$$P = \sum_{t=1}^n \left[ \frac{D_0(1+g_1)^t}{(1+k_e)^t} \right] + \frac{D_0(1+g_2)}{k_e - g_2} \left[ \frac{1}{(1+k_e)^t} \right]$$

where:  $P$  = intrinsic value = PV of dividends + PV of price

$D_t$  = expected dividend

$k_e$  = appropriate discount factor for the investment

$g_1$  = initial dividend growth rate

$g_2$  = steady dividend growth rate

### Linters Model

Linter model has two parameters:

- The target payout ratio; and
- The spread at which current dividends adjust to the target.

John Linter based his model on a series of interviews which he conducted with corporate managers in the mid 1950's. While developing the model, he considered the following assumptions:



- (i) The companies have a long term dividend payout ratio. They maintain a fixed dividend payout over a long term. Mature companies with stable earnings may have high payouts and growth companies usually have low payouts.
- (ii) Managers are more concerned with changes in dividends than the absolute amounts of dividends. A manager may easily decide to pay a dividend of ₹ 2 per share if last year also it was ₹ 2 but paying ₹ 3 dividend if last year dividend was ₹2 is an important financial management decision.
- (iii) Dividend changes follow the changes in the long run on sustainable earnings.
- (iv) Managers are reluctant to affect dividend changes that may have to be reversed.

As per Linter's model, the current year's dividend is dependent on current year's earnings and last year's dividend.

$$D_1 = D_0 + [(EPS \times \text{Target payout}) - D_0] \times Af$$

Where

$D_1$  = Dividend in year 1

$D_0$  = Dividend in year 0 (last year dividend)

EPS = Earnings per share

Af = Adjustment factor.

### MEASURES OF DIVIDEND POLICY

**Dividend Payout:** measures the percentage of earnings the company pays in dividends = Dividends / Earnings.

**Dividend Yield:** measures the return that an investor can make from dividends alone = Dividends / Stock Price.

**Earnings Yield:** measures how earnings are reflected in the share price = Earnings / Stock Price.

### Modigliani and Miller - Irrelevancy Theory

Modigliani and Miller has argued that a firm's dividend policy has no effect on its value of assets. For example, if the rate of dividend declared by a company is less, its retained earnings will increase and also the net worth and vice-versa. Their argument is that the value of the firm is unaffected on a number of assumptions the most important of which were:

- There are no personal or corporate income taxes.
- There are no stock floatation or transaction costs.
- Dividend policy has no effect on the firm's cost of equity.
- The firm's capital investment policy is independent of its dividend policy.
- Investors and managers have the same set of information (symmetric information) regarding future opportunities.

The reason given by MM is that the value of the firm is determined by its basic earnings power and its risk class, and therefore, that the firm's value depend on its asset investment policy rather than on how earnings are split between dividends, and retained earnings. MM demonstrated, under a particular set of assumptions, that if a firm pays higher dividends, then it must sell more stocks to new investors, and that the share of the value of the company given up to new investors is exactly equal to the dividends paid out. The value of the firm was not determined by the amount of dividends paid, but rather by the earnings power of the projects in which the firm invested its money.



The argument used by MM to support this key assumption is referred to as the 'Clientele effect'. The clientele effect states that a firm will attract stockholders whose preferences with respect to the payment pattern and stability of dividends corresponds to the firm's payment and stability of dividends. Since the shareholders, or the clientele of the firm get what they expect, the value of the firm's stocks unaffected by changes in its dividend policy.

According to M.M Model the market price of a share after dividend declared is calculated by applying the following formula:

$$P_0 = \frac{P_1 + D_1}{1 + k_e}$$

Where,

$P_0$  = The prevailing market price of a share

$K_e$  = The cost of Equity Capital

$D_1$  = Dividend to be received at the end of period one

$P_1$  = Market price of a share at the end of period one

### **Modigliani and Miller - Dividend Irrelevancy Model**

$$P_0 = \frac{P_1 + D_1}{1 + k_e}$$

### **Determinants of dividend policy**

Many factors determine the dividend policy of a company. The factors determining the dividend policy can be classified into:

- (i) Dividend payout ratio
- (ii) Stability of dividends
- (iii) Legal, contractual and internal constraints and restriction.
- (iv) Owners considerations
- (v) Capital market conditions
- (vi) Inflation
- (vii) General corporate behaviour regarding dividend or the practices of the Industry.

Each of the above points are further discussed as given here in below:

- (i) **Dividend Payout ratio:** Dividend Payout ratio indicates the percentage of a company's earnings that are paid out to the shareholders in cash. It is calculated by dividing annual cash dividends by annual earnings. It may also be calculated by dividing dividends per share by earnings per share. A certain share of earnings to be distributed as dividend has to be worked out. This involves the decision to pay out or to retain. The payment of dividends results in the reduction of cash and, therefore, depletion of assets. In order to maintain the desired level of assets as well as to finance the investment opportunities, the company has to decide upon the payout ratio. D/P ratio should be determined with two bold objectives – maximising the wealth of the firms' owners and providing sufficient funds to finance growth.
- (ii) **Stability of Dividends:** Generally investors favour a stable dividend policy. The policy should be consistent and there should be a certain minimum dividend that should be paid regularly. The liability can take any form, namely, constant dividend per share; stable D/P ratio and constant dividend per share plus something extra. Because this entails – the investor's desire for current





income, it contains the information content about the profitability or efficient working of the company; creating interest for institutional investor's etc.

- (iii) **Legal, contractual and internal constraints and restriction:** Legal and Contractual requirements have to be followed. All requirements of Companies Act, SEBI guidelines, capital impairment guidelines, net profit and insolvency etc., have to be kept in mind while declaring dividend. For example, insolvent firm is prohibited from paying dividends; before paying dividend accumulated losses have to be set off, however, the dividends can be paid out of current or previous years' profit. Also there may be some contractual requirements which are to be honoured. Maintenance of certain debt equity ratio may be such requirements. In addition, there may be certain internal constraints which are unique to the firm concerned. There may be growth prospects, financial requirements, availability of funds, earning stability and control etc.
- (iv) **Owner's considerations:** This may include the tax status of shareholders, their opportunities for investment dilution of ownership etc.
- (v) **Capital market conditions and inflation:** Capital market conditions and rate of inflation also play a dominant role in determining the dividend policy. The extent to which a firm has access to capital market, also affects the dividend policy. A firm having easy access to capital market will follow liberal dividend policy as compared to the firm having limited access. Sometime dividends are paid to keep the firms 'eligible' for certain things in the capital market. In inflation, rising prices eat into the value of money of investors which they are receiving as dividends. Good companies will try to compensate for rate of inflation by paying higher dividends. Replacement decision of the companies also affects the dividend policy.

### Dividend Decision and Tax Considerations

Traditional theories might have said that distribution of dividend being from after-tax profits, tax considerations do not matter in the hands of the payer-company. However, with the arrival of Corporate Dividend Tax on the scene in India, the position has changed. Since there is a clear levy of such tax with related surcharges, companies have a consequential cash outflow due to their dividend decisions which has to be dealt with as and when the decision is taken.

In the hands of the investors too, the position has changed with total exemption from tax being made available to the receiving-investors. In fact, it can be said that such exemption from tax has made the equity investment and the investment in Mutual Fund Schemes very attractive in the market.

Broadly speaking Tax consideration has the following impacts on the dividend decision of a company:

**Before introduction of dividend tax:** Earlier, the dividend was taxable in the hands of investor. In this case the shareholders of the company are corporate or individuals who are in higher tax slab, it is preferable to distribute lower dividend or no dividend. Because dividend will be taxable in the hands of the shareholder @ 30% plus surcharges while long term capital gain is taxable @ 10%. On the other hand, if most of the shareholders are the people who are in no tax zone, then it is preferable to distribute more dividends.

We can conclude that before distributing dividend, company should look at the shareholding pattern.

**After introduction of dividend tax:** Dividend tax is payable @ 12.5% - surcharge + education cess, which is effectively near to 14%. Now if the company were to distribute dividend, shareholder will indirectly bear a tax burden of 14% on their income. On the other hand, if the company were to provide return to shareholder in the form of appreciation in market price – by way of Bonus shares – then shareholder will have a reduced tax burden. For securities on which STT is payable, short term capital gain is taxable @ 10% while long term capital gain is totally exempt from tax.

Therefore, we can conclude that if the company pays more and more dividend (while it still have reinvestment opportunities) then to get same after tax return shareholders will expect more before tax return and this will result in lower market price per share.



Walter's approach to Dividend Policy: Walter's approach to Dividend Policy supports the doctrine that the investment policy of a firm cannot be separated from its dividend policy and both are according to him interlinked. He argues that in the long run, share prices reflect only the present value of expected dividends. Retention influences stock prices only through their effect on future dividends.

The relationship between dividend and share price on the basis of Walter's formula is shown below:

$$P_0 = \frac{D + R_a \frac{(E - D)}{R_c}}{R_c}$$

Where,

$V_c$  = Market value of ordinary shares of the company.

$R_a$  = Return on internal retention, i.e. the rate company earns on retained profits.

$R_c$  = Capitalisation rate, i.e. the rate expected by investors by way of return from particular category of shares.

$E$  = Earnings per share.

$D$  = Dividend per share.

Prof. Walter's formula is based on the relationship between the firm's (i) return on investment or internal rate of return ( $R_a$ ) and (ii) Cost of Capital or required rate of return (i.e.  $R_c$ ).

The optimum dividend policy of a firm is determined by the relationship of  $R_a$  and  $R_c$ . If  $R_a > R_c$  i.e. the firm can earn higher return than what the shareholders can earn on their investments, the firm should retain the earning. Such firms are termed as growth firms, and in their case the optimum dividend policy would be to plough back the earnings. If  $R_a < R_c$  i.e. the firm does not have profitable investment opportunities, the optimum dividend policy would be to distribute the entire earnings as dividend.

In case of firms, where  $R_a = R_c$ , it does not matter whether the firm retains or distribute its earning.

Assumptions: Walter's dividend policy is based on the following assumptions:

- (i) The firm does the entire financing through retained earnings. It does not use external sources of funds such as debt or new equity capital.
- (ii) The firm  $R_c$  and  $R_a$  remain constant with additional investment.
- (iii) There is no change in the key variables, namely, beginning  $E$ ,  $D$ .
- (iv) The firm has a very long life.

### Stock Splits

Stock splits means splitting one share into many, say, one share of ₹100 into 5 shares of ₹20. Stock splits is a tool used by the companies to regulate the prices of shares i.e. if a share price increases beyond a limit, it may become less tradable, for example, let us suppose a company's share price increases from ₹50 to ₹1000 over the years, it is possible that many small investors may not be able to trade on this share.

There are various advantages of Stock Splits as follows:

- a. It makes the share affordable to small investors.
- b. Number of shares may increase the number of shareholders. Therefore, the potential of investment may increase.

There are various limitations of Stock Splits such as;

- (i) Additional expenditure need to be incurred on the process of stock split.



- (ii) Low share price may attract speculators or short term investors, which are generally not preferred by any company.

**Illustration: 33**

Sahu & Co. earns ₹6 per share having capitalisation rate of 10 per cent and has a return on investment at the rate of 20 per cent. According to Walter's model, what should be the price per share at 30 per cent dividend payout ratio? Is this the optimum payout ratio as per Walter?

**Solution:**

$$\text{Walter Model is } V_c = \frac{D + \frac{R_a}{R_c}(E - D)}{R_c}$$

Where:

$V_c$  = Market value of the share

$R_a$  = Return on Retained earnings

$R_c$  = Capitalisation Rate

E = Earning per share

D = Dividend per share

Hence, if Walter model is applied

$$\text{Market value of the share } P = \frac{1.80 + \frac{0.20}{0.10}(6 - 1.80)}{0.10}$$

$$= \frac{1.80 + \frac{0.20}{0.10}(6 - 1.80)}{0.10}$$

$$= ₹ 102$$

This is not the optimum payout ratio because  $R_a > R_c$  and therefore  $V_c$  can further go up if payout ratio is reduced.

**Illustration: 34**

X Ltd., has 8 lakhs equity shares outstanding at the beginning of the year 2005. The current market price per share is ₹120. The Board of Directors of the company is contemplating ₹6.4 per share as dividend. The rate of capitalisation, appropriate to the risk-class to which the company belongs, is 9.6%:

- (i) Based on M-M Approach, calculate the market price of the share of the company, when the dividend is – (a) declared; and (b) not declared.
- (ii) How many new shares are to be issued by the company, if the company desires to fund an investment budget of ₹3.20 crores by the end of the year assuming net income for the year will be ₹1.60 crores?

**Answer:**

Modigliani and Miller (M-M) – Dividend Irrelevancy Model:

$$P_0 = \frac{P_1 + D_1}{1 + k_e}$$



Where

$P_0$  = Existing market price per share i.e. ₹120

$P_1$  = Market price of share at the yearend (to be determined)

$D_1$  = Contemplated dividend per share i.e. ₹6.4

$K_e$  = Capitalisation rate i.e. 9.6%.

(i) (a) **Calculation of share price when dividend is declared:**

$$P_0 = \frac{P_1 + D_1}{1 + k_e}$$

$$120 = \frac{P_1 + 6.4}{1 + 0.096}$$

$$120 \times 1.096 = P_1 + 6.4$$

$$P_1 = 120 \times 1.096 - 6.4$$

$$= 125.12$$

(b) **Calculation of share price when dividend is not declared:**

$$P_0 = \frac{P_1 + D_1}{1 + k_e}$$

$$120 = \frac{P_1 + 0}{1 + 0.096}$$

$$120 \times 1.096 = P_1 + 0$$

$$P_1 = 131.52$$

(ii) **Calculation of No. of shares to be issued**

(₹ in lakhs)

Particulars	If dividend declared	If dividend not declared
Net Income	160	160
Less: Dividend paid	51.20	
Retained earnings	108.80	160
Investment budget	320	320
Amount to be raised by issue of new shares (i)	211.20	160
Market price per share (ii)	125.12	131.52
No. of new shares to be issued (ii)	1,68,797.95	1,21,654.50
Or say	1,68,798	1,21,655

### Illustration: 35

Capital structure of Sun Ltd., as at 31.3.2016 was as under:

	(₹ in lakhs)
Equity share capital	80
8% Preference share capital	40
12% Debentures	64
Reserves	32



Sun Ltd., earns a profit of ₹32 lakhs annually on an average before deduction of income-tax, which works out to 35%, and interest on debentures.

Normal return on equity shares of companies similarly placed is 9.6% provided:

- Profit after tax covers fixed interest and fixed dividends at least 3 times.
- Capital gearing ratio is 0.75.
- Yield on share is calculated at 50% of profits distributed and at 5% on undistributed profits. Sun Ltd., has been regularly paying equity dividend of 8%.

Compute the value per equity share of the company.

**Answer:**

#### Calculation of Profit after tax (PAT)

	(₹)
Profit before interest and tax (PBIT)	32,00,000
Less: Debenture interest (₹64,00,000 × 12/100)	7,68,000
Profit before tax (PBT)	24,32,000
Less: Tax @ 35%	8,51,200
Profit after tax (PAT)	15,80,800
Less: Preference Dividend	
(₹40,00,000 × 8/100)	3,20,000
Equity Dividend (₹80,00,000 × 8/100)	6,40,000
Retained earnings (Undistributed profit)	6,20,800

#### Calculation of Interest and Fixed Dividend Coverage

$$= \frac{\text{PAT} + \text{Debenture interest}}{\text{Debenture interest} + \text{Preference interest}} = \frac{15,80,800 + 7,68,000}{7,68,000 + 3,20,000} = \frac{23,48,800}{10,88,000} = 2.16 \text{ times}$$

#### Calculation of Capital Gearing Ratio

$$\begin{aligned} \text{Capital Gearing Ratio} &= \frac{\text{Fixed Interest bearing funds}}{\text{Equity Shareholders' funds}} \\ &= \frac{\text{Preference Share Capital} + \text{Debentures}}{\text{Equity Share Capital} + \text{Reserves}} \\ &= \frac{40,00,800 + 65,00,000}{80,00,000 + 32,00,000} = \frac{1,04,00,000}{1,12,00,000} = 0.93 \text{ times} \end{aligned}$$

**Calculation of Yield on Equity Shares**

Yield on equity shares is calculated at 50% of profits distributed and 5% on undistributed profits:

	(₹)
50% on distributed profits (₹6,40,000 × 50/100)	3,20,000
5% on undistributed profits (₹6,20,800 × 5/100)	31,040
Yield on equity shares	3,51,040

$$\begin{aligned}\text{Yield on equity shares \%} &= \frac{\text{Yield on shares}}{\text{Equity Share Capital}} \times 100 \\ &= \frac{3,51,040}{80,00,000} \times 100 = 4.39\% \text{ or, } 4.388\%.\end{aligned}$$

**Illustration: 36**

Mr. A is contemplating purchase of 1,000 equity shares of a Company. His expectation of return is 10% before tax by way of dividend with an annual growth of 5%. The Company's last dividend was ₹2 per share. Even as he is contemplating, Mr. A suddenly finds, due to a budget announcement dividends have been exempted from tax in the hands of the recipients. But the imposition of dividend Distribution tax on the Company is likely to lead to a fall in dividend of 20 paise per share. A's marginal tax rate is 30%.

Required:

Calculate what should be Mr. A's estimates of the price per share before and after the Budget announcement?

**Answer:**

The formula for determining value of a share based on expected dividend is:

$$P_0 = \frac{D_0(1+g)}{(k-g)}$$

Where

$P_0$  = Price (or value) per share

$D_0$  = Dividend per share

$g$  = Growth rate expected in dividend

$k$  = Expected rate of return

Hence,

Price estimate before budget announcement:

$$P_0 = \frac{2 \times (1 + 0.05)}{(0.10 - 0.05)} = ₹42.00$$

Price estimate after budget announcement:

$$P_0 = \frac{1.80 \times (1.05)}{(0.07 - 0.05)} = ₹94.50$$



**Illustration: 37**

A Company pays a dividend of ₹2.00 per share with a growth rate of 7%. The risk free rate is 9% and the market rate of return is 13%. The Company has a beta factor of 1.50. However, due to a decision of the Finance Manager, beta is likely to increase to 1.75. Find out the present as well as the likely value of the share after the decision.

**Answer:**

In order to find out the value of a share with constant growth model, the value of  $K_e$  should be ascertained with the help of 'CAPM' model as follows:  $K_e = R_f + \beta(K_m - R_f)$

Where,

$K_e$  = Cost of equity

$R_f$  = Risk free rate of return

$\beta$  = Portfolio Beta i.e. market sensitivity index

$K_m$  = Expected return on market portfolio

By substituting the figures, we get

$$K_e = 0.09 + 1.5 (0.13 - 0.09) = 0.15 \text{ or } 15\%$$

and the value of the share as per constant growth model is  $P_0 = \frac{D_1}{(k_e - g)}$

Where

$P_0$  = Price of a share

$D_1$  = Dividend at the end of the year 1

$K_e$  = Cost of equity

$G$  = growth

$$P_0 = \frac{2.00}{(k_e - g)}$$

$$P_0 = \frac{2.00}{0.15 - 0.07}$$

$$= ₹ 25.0$$

However, if the decision of finance manager is implemented, the beta ( $\beta$ ) factor is likely to increase to 1.75 therefore,  $K_e$  would be

$$K_e = R_f + \beta (K_m - R_f)$$

$$= 0.09 + 1.75 (0.13 - 0.09)$$

$$= 0.16 \text{ or } 16\%$$

The value of share is

$$P_0 = \frac{D_1}{(k_e - g)}$$

$$P_0 = \frac{2.00}{0.16 - 0.07}$$

$$= ₹ 22.22$$

**Illustration: 38**

The following figures are collected from the annual report of XYZ Ltd.:

	(₹)
Net Profit	30 lakhs
Outstanding 12% preference shares	100 lakhs
No. of equity shares	3 lakhs
Return on Investment	20%

What should be the approximate dividend pay-out ratio so as to keep the share price at ₹42 by using Walter model?

**Answer:**

₹ in lakhs

Net Profit	30
Less: Preference dividend	12
Earning for equity shareholders	18
Therefore earning per share	18/3 = ₹ 6.00
Cost of capital i.e. ( $k_e$ )	
(Assumed)	16%

Let, the dividend pay-out ratio be X and so the share price will be:

$$P = \frac{D}{k_e} + \frac{r(E-D)}{k_e}$$

Here  $D = 6x$ ;  $E = ₹ 6$ ;  $r = 0.20$  and  $K_e = 0.16$  and  $P = ₹ 42$

$$\text{Hence } ₹ 42 = \frac{6x}{0.16} + \frac{0.2(6 - 6x)}{0.16 \times 0.16}$$

$$\text{Or } ₹ 42 = 37.50X + 46.875 (1 - x)$$

$$= 9.375x = 4.875$$

$$x = 0.52$$

So, the required dividend payout ratio will be = 52%

**Illustration: 39**

The following information pertains to M/s XY Ltd.

Earnings of the Company	₹ 5,00,000
Dividend Payout ratio	60%
No. of shares outstanding	1,00,000
Equity capitalization rate	12%
Rate of return on investment	15%





### Cost of Capital & Capital Structure

- (i) What would be the market value per share as per Walter's model?  
 (ii) What is the optimum dividend payout ratio according to Walter's model and the market value of Company's share at that payout ratio?

**Answer:**

(a) M/s X Y Ltd.

(i) Walter's model is given by

$$P = \frac{D + (E - D)(r / K_e)}{K_e}$$

Where P = Market price per share.

E = Earnings per share = ₹5

D = Dividend per share = ₹3

r = Return earned on investment = 15%

$K_e$  = Cost of equity capital = 12%

$$P = \frac{2 + (5 - 3) \times \frac{0.15}{0.12}}{0.12} = \frac{3 + 2.0 \times \frac{.15}{.12}}{0.12}$$

$$= ₹52.08$$

(ii) According to Walter's model when the return on investment is more than the cost of equity capital, the price per share increases as the dividend pay-out ratio decreases. Hence, the optimum dividend pay-out ratio in this case is nil.

So, at a pay-out ratio of zero, the market value of the company's share will be:  $\frac{0 + (5 - 0) \frac{0.15}{0.12}}{0.12} = 52.08$

**Illustration: 40**

ABC Ltd. has 50,000 outstanding shares. The current market price per share is ₹100 each. It hopes to make a net income of ₹5,00,000 at the end of current year. The Company's Board is considering a dividend of ₹5 per share at the end of current financial year. The company needs to raise ₹10,00,000 for an approved investment expenditure. The company belongs to a risk class for which the capitalization rate is 10%. Show, how does the M-M approach affect the value of firm if the dividends are paid or not paid.

**Answer:**

When dividends are paid

$$100 = (5 + P_1) / (1 + 0.10)$$

Therefore,  $P_1 = ₹105/-$ .

Value of firm

$$= ₹([50,000 + 7,50,000 / 105] \times 105) - 10,00,000 + 5,00,000 / 1.10$$

$$= ₹(60,00,000 - 5,00,000) / 1.10$$

$$= ₹50,00,000.$$



When dividend is not paid

$$100 = 1/1.1 \times P_1$$

Therefore,  $P_1 = ₹110$ .

Value of firm

$$= ₹([50,000 + (5,00,000/110) \times 110] - 10,00,000 + 5,00,000)/1.10$$

$$= ₹(60,00,000 - 5,00,000)/1.10$$

$$= ₹50,00,000$$

M.M. approach indicates that the value of the firm in both the situations will be the same.

#### Illustration: 41

The following information are supplied to you:

	(₹)
Total Earnings	2,00,000
No. of equity shares (of ₹100 each)	20,000
Dividend paid	1,50,000
Price/Earning ratio	12.5

- Ascertain whether the company is the following an optimal dividend policy.
- Find out what should be the P/E ratio at which the dividend policy will have no effect on the value of the share.
- Will your decision change, if the P/E ratio is 8 instead of 12.5?

#### Answer:

- The EPS of the firm is ₹10 (i.e., ₹2,00,000/20,000). The P/E Ratio is given at 12.5 and the cost of capital,  $k_e$ , may be taken at the inverse of P/E ratio. Therefore,  $k_e$  is 8 (i.e.,  $1/12.5$ ). The firm is distributing total dividends of ₹1,50,000 among 20,000 shares, giving a dividend per share of ₹7.50. the value of the share as per Walter's model may be found as follows:

$$\begin{aligned} P &= \frac{D}{K_e} + \frac{(r/K_e)(E-D)}{K_e} \\ &= \frac{7.50}{.08} + \frac{(.01/.08)(10-7.5)}{.08} \\ &= ₹132.81 \end{aligned}$$

The firm has a dividend payout of 75% (i.e., ₹1,50,000) out of total earnings of ₹2,00,000. since, the rate of return of the firm,  $r$ , is 10% and it is more than the  $k_e$  of 8%, therefore, by distributing 75% of earnings, the firm is not following an optimal dividend policy. The optimal dividend policy for the firm would be to pay zero dividend and in such a situation, the market price would be



$$\begin{aligned}
 P &= \frac{D}{K_e} + \frac{(r/K_e)(E-D)}{K_e} \\
 &= \frac{0}{.08} + \frac{(.01/.08)(10-0)}{.08} \\
 &= ₹156.25
 \end{aligned}$$

So, theoretically the market price of the share can be increased by adopting a zero payout.

- (i) The P/E ratio at which the dividend policy will have no effect on the value of the share is such at which the  $k_e$  would be equal to the rate of return,  $r$ , of the firm. The  $K_e$  would be 10% ( $=r$ ) at the P/E ratio of 10. Therefore, at the P/E ratio of 10, the dividend policy would have no effect on the value of the share.
- (ii) If the P/E is 8 instead of 12.5, then the  $k_e$  which is the inverse of P/E ratio, would be 12.5 and in such a situation  $k_e > r$  and the market price, as per Walter's model would be

$$\begin{aligned}
 P &= \frac{D}{K_e} + \frac{(r/K_e)(E-D)}{K_e} \\
 &= \frac{7.50}{.125} + \frac{(.1/.125)(10-7.5)}{.125} \\
 &= ₹76
 \end{aligned}$$

## 9.4 LEVERAGE ANALYSIS

### LEVERAGES

Leverage is the use of fixed assets in order to increase profitability. The concept of leverage has its origin in science. It means influence of one force over another. Since financial items are inter-related, change in one, causes change in profit. In the context of financial management, the term 'leverage' means sensitiveness of one financial variable to change in another. The measure of this sensitiveness is expressed as a ratio and is called degree of leverage.

Algebraically, the leverage may be defined as,

$$\text{Leverage} = \frac{\% \text{ change in one variable}}{\% \text{ change in some other variable}}$$

### Measures of Leverage

To understand the concept of leverage, it is imperative to understand the three measures of Leverage which are as follows:

- (i) Operating Leverage
- (ii) Financial Leverage
- (iii) Combined Leverage

#### (i) Operating Leverage

Operating Leverage is the leverage arising from fixed operating costs. Operating Leverage reflects the impact of change in sales on the level of operating profits of the firm.



The significance of DOL may be interpreted as follows:

- Other things remaining constant, higher the DOL, higher will be the change in EBIT for same change in number of units sold in, if firm A has higher DOL than firm B, profits of firm A will increase at faster rate than that of firm B for same increase in demand.

This however works both ways and so losses of firm A will increase at faster rate than that of firm B for same fall in demand. This means higher the DOL, more is the risk.

- DOL is high where contribution is high.
- There is a unique DOL for each level of output.

$$\text{Thus, DOL} = \frac{\text{Contribution}}{\text{EBIT}}$$

### (ii) Financial Leverage

The Financial Leverage may be defined as a % increase in EPS associated with a given percentage increase in the level of EBIT. Financial leverage emerges as a result of fixed financial charge against the operating profits of the firm. The fixed financial charge appears in case the funds requirement of the firm are partly financed by the debt financing. By using this relatively cheaper source of finance, in the debt financing, the firm is able to magnify the effect of change in EBIT on the level of EPS.

The significance of DFL may be interpreted as follows :

- Other things remaining constant, higher the DFL, higher will be the change in EPS for same change in EBIT. In other words, if firm K has higher DFL than firm L, EPS of firm K increases at faster rate than that of firm L for same increase in EBIT. However, EPS of firm K falls at a faster rate than that of firm K for same fall in EBIT. This means, higher the DFL more is the risk.
- Higher the interest burden, higher is the DFL, which means more a firm borrows more is its risk.
- Since DFL depends on interest burden, it indicates risk inherent in a particular capital mix, and hence the name financial leverage.

There is a unique DFL for each amount of EBIT.

While operating leverage measures the change in the EBIT of a company to a particular change in the output, the financial leverage measures the effect of the change in EBIT on the EPS of the company.

Thus the degree of financial leverage (DFL) is ratio between proportionate change in EPS and proportionate change in EBIT.

$$\text{DFL} = \frac{\text{Earning before interest and tax}}{\text{Earning after interest}} = \frac{\text{EBIT}}{\text{EBT}}$$

### (iii) Combined Leverage

A combination of the operating and financial leverages is the total or Combination Leverage.

The operating leverage causes a magnified effect of the change in sales level on the EBIT level and if the financial leverage combined simultaneously, then the change in EBIT will, in turn, have a magnified effect on the EPS. A firm will have wide fluctuations in the EPS for even a small change in the sales level. Thus effect of change in sales level on the EPS is known as combined leverage.

Thus Degree of Combined Leverage may be calculated as follows:

$$\text{DCL} = \frac{\text{Contribution}}{\text{Earning after interest}} = \frac{C}{\text{EBT}}$$



### 9.5 EBIT - EPS INDIFFERENCE POINT/LEVEL

The basic objective of financial management is to design an appropriate capital structure which can provide the highest earnings per share (EPS) over the company's expected range of earnings before interest and taxes (EBIT).

EPS measures a company's performance for the shareholders. The level of EBIT varies from year to year and represents the success of a company's operations. EBIT-EPS analysis is a vital tool for designing the optimal capital structure of a company. The objective of this analysis is to determine the EBIT level that will equate EPS regardless of the financing plan chosen.

The financial leverage affects the pattern of distribution of operating profit among various types of investors and increases the variability of the EPS of the company. Therefore, in search for an appropriate capital structure for a company, the financial manager must analyse the effects of various alternative financial leverages on the EPS. Given a level of EBIT, EPS will be different under different financing mix depending upon the extent of debt financing. The effect of leverage on the EPS emerges because of the existence of fixed financial charge i.e., interest on debt financial fixed dividend on preference share capital. The effect of fixed financial charge on the EPS depends upon the relationship between the rate of return on assets and the rate of fixed charge. If the rate of return on assets is higher than the cost of financing, then the increasing use of fixed charge financing (i.e., debt and preference share capital) will result in increase in the EPS. This situation is also known as favourable financial leverage or *Trading on Equity*. On the contrary, if the rate of return on assets is less than the cost of financing, then the effect may be negative and, therefore, the increasing use of debt and preference share capital may reduce the EPS of the company.

The fixed financial charge financing may further be analysed with reference to the choice between the debt financing and the issue of preference shares. Theoretically, the choice is tilted in favour of debt financing for two reasons: (a) the explicit cost of debt financing i.e., the rate of interest payable on debt instruments or loans is generally lower than the rate of fixed dividend payable on preference shares, and (b) interest on debt financing is tax-deductible and therefore the real cost (after-tax) is lower than the cost of preference share capital.

The analysis of the different types of capital structure and the effect of leverage on the expected EPS will provide a useful guide to selection of a particular level of debt financing. The EBIT-EPS analysis is of significant importance and if undertaken properly, can be an effective tool in the hands of a financial manager to get an insight into the planning and designing of the capital structure of the company.

The indifference level of EBIT is one at which the EPS remains same irrespective of the debt-equity mix. While designing a capital structure, a firm may evaluate the effect of different financial plans on the level of EPS, for a given level of EBIT. Out of several available financial plans, the firm may have two or more financial plans which result in the same level of EPS for a given EBIT. Such a level of EBIT at which the firm has two or more financial plans resulting in same level of EPS, is known as indifference level of EBIT.

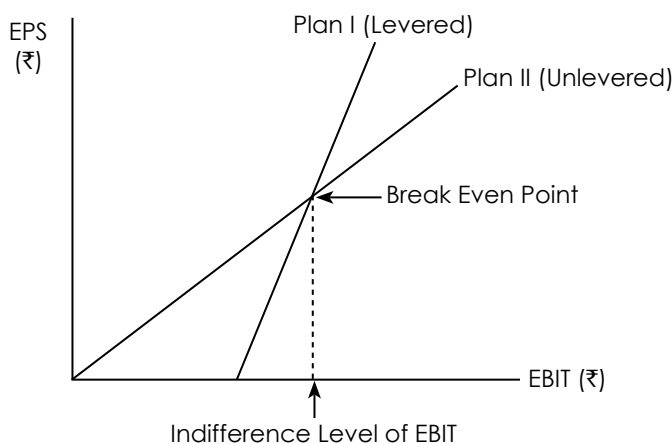

**Graphical Presentation of Indifference Level**

Thus, the indifference level of EBIT is one at which the EPS under different financial plans are expected to be same. If the EBIT is more than the indifference level, the financial leverage being to operate resulting increase in EPS. However, if the EBIT is less than the indifferent level, then the EPS is expected to decrease as a result of debt financing. So, the expected level of EBIT should be more than the indifference level EBIT in order to avail the benefits of financial leverage i.e., debt financing from the point of view of equity shareholders. However, if the expected EBIT is less than the indifference level EBIT, the firm should raise the funds by issuing equity share capital only and avoid the debt financing.

The intersection between the EPS lines that represent the EBIT break-even points or indifference level of EBIT can be quite easily calculated. For this purpose, one has to formulate simple equations for the conditions underlying any intersecting pair of line. EPS are then set as equal for the two alternatives, and the equations are solved for the value of EBIT level at which this condition hold.

### CALCULATION OF INDIFFERENCE POINT

For calculation of indifference EBIT:

	EPS under Plan I (100% equity)	EPS under Plan II (Debt Plan)	EPS under Plan III (Preference Capital)
EPS	$\frac{\text{EBIT}(1-t)}{N_a}$	$\frac{\text{EBIT} - I(1-t)}{N_b}$	$\frac{\text{EBIT}(1-t) - \text{P.D.}}{N_c}$

Where EBIT = Earnings before interest and taxes

t = Corporate tax rate

$N_a = N_b = N_c =$  No. of equity shares under different plans.

Where Plan I = 100% equity

Plan II = Debt plan

Plan III = Preference Capital

### Interpretation of the Indifference Point

Situation	Option	Reason
EBIT below Indifference Point	Option with lower debt (Interest Burden)	When rate of earnings and operating profits (EBIT) are low, more interest and debt burden is not advisable. A high DOL should be properly managed by low Financial Leverage.
EBIT equal to Indifference Point	Any alternative can be chosen.	Same EPS due to Indifference Point.
EBIT above Indifference Point	Option with higher debt (Interest Burden)	When EBIT is high, Financial Leverage works till the EPS is maximised. Low DOL should be coupled with high DFL, to maximize gain of Equity Shareholders.

### Limitations of EBIT- EPS Analysis

If maximisation of the EPS is the only criterion for selecting the particular debt-equity mix, then that capital structure which is expected to result in the highest EPS will always be selected by all the companies. However, achieving the highest EPS need not be the only goal of the company. The main limitations of the EBIT-EPS analysis are as follows:

- The EPS criterion ignores the risk dimension. The EBIT-EPS analysis ignores as to what is the effect of leverage on the overall risk of the company. With every increase in financial leverage, the risk of the company and that of investors also increases. The EBIT-EPS analysis fails to deal with the variability of EPS and the risk return trade-off.



- (b) EPS is more of a performance measure. It basically depends upon the operating profit which, in turn, depends upon the operating efficiency of the company. It is a resultant figure and more a measure of performance rather than a measure of decision making.

**Illustration: 42**

Crompton Ltd. a profit making company has a paid-up capital of ₹100 lakhs consisting of 10 lakhs ordinary shares of ₹10 each. Currently, it is earning an annual pre-tax profit of ₹60 lakhs. The company's shares are listed and are quoted in the range of ₹50 to ₹80. The management wants to diversify production and has approved a project which will cost ₹50 lakhs and which is expected to yield a pre-tax income of ₹40 lakhs per annum. To raise this additional capital, the following options are under consideration of the management:

- To issue equity share capital for the entire additional amount. It is expected that the new shares (face value of ₹10) can be sold at a premium of ₹15.
- To issue 16% non-convertible debentures of ₹100 each for the entire amount.
- To issue equity capital for ₹25 lakhs (face value of ₹ 10) and 16% non-convertible debentures for the balance amount. In this case, the company can issue shares at a premium of ₹40 each.

Advise the management as to how the additional capital can be raised, keeping in mind that the management wants to maximise the earnings per share to maintain its goodwill. The company pays income tax at 50%.

**Solution:**
**Calculation of Earnings per share under three options**

Particulars	Options		
	Option I: Issue Equity shares only	Option II: Issue 16% Debentures only	Option III: Issue Equity shares and 16% debentures of equal amount
Number of Equity Shares:			
- Existing	10,00,000	10,00,000	10,00,000
- Newly issued	2,00,000	-----	50,000
	$\left( \frac{₹50,00,000}{₹(10+15)} \right)$		$\left( \frac{₹25,00,000}{₹(10+40)} \right)$
Total	12,00,000	10,00,000	10,50,000
16% Debentures (₹)	-----	50,00,000	25,00,000
	₹	₹	₹
Profit Before Interest and Tax:			
- Existing pre-tax profit	60,00,000	60,00,000	60,00,000
- From new projects	40,00,000	40,00,000	40,00,000
	1,00,00,000	1,00,00,000	1,00,00,000
Less: Interest on 16% Debentures	-----	8,00,000 (16% × ₹50,00,000)	4,00,000 (16% × ₹25,00,000)
Profit before Tax	1,00,00,000	92,00,000	96,00,000
Tax at 50%	50,00,000	46,00,000	48,00,000
Profit After tax	50,00,000	46,00,000	48,00,000
Earnings Per Share (EPS)	4.17	4.60	4.57
$\left( \frac{\text{PAT}}{\text{No. of Shares}} \right)$	$\left( \frac{₹50,00,000}{12,00,000} \right)$	$\left( \frac{₹46,00,000}{10,00,000} \right)$	$\left( \frac{₹48,00,000}{10,50,000} \right)$



Advise: Option II i.e. issue of 16% Debentures is most suitable to maximize the earnings per share.

### **Over-Capitalisation and Under-Capitalisation**

#### **Over- Capitalisation**

Over – capitalisation is a situation where a company has more capital than it needs or in other words assets are worth less than its issued share capital, and earnings are insufficient to pay dividend and interest. This situation mainly arises when the existing capital is not effectively utilised due to fall in earning capacity of the company while company has raised funds more than its requirements. The main signal of over-capitalisation is the fall in payment of dividend and interest leading to fall in value of the shares of the company.

Over-capitalisation arises due to following **reasons**:

- (a) Raising more money through issue of shares or debentures than company can employ profitably
- (b) Borrowing huge amount at higher rate than rate at which company can earn
- (c) Excessive payment for the acquisition of fictitious assets such as goodwill etc.
- (d) Improper provision for depreciation, replacement of assets and distribution of dividends at a higher rate
- (e) Wrong estimation of earnings and capitalisation

Over-capitalisation causes the following **implications**:

- (i) Considerable reduction in the rate of dividend and interest payments
- (ii) Reduction in the market price of shares
- (iii) Resorting to window dressing
- (iv) Opting for reorganisation

Following **steps** may be adopted to avoid the negative consequences of over-capitalisation:

- (i) Company should go for thorough reorganisation.
- (ii) Buyback of shares
- (iii) Reduction in claims of debenture-holders and creditors
- (iv) Value of shares may be reduced. This will result in sufficient funds for the company to carry out replacement of assets.

#### **Under- Capitalisation**

Under Capitalisation is just opposite of over-capitalisation. When its actual capitalisation is lower than its proper capitalisation as warranted by its earning capacity it is a state of under –capitalisation. This situation normally arises with companies which have insufficient capital but large secret reserves in the form of considerable appreciation in the values of the fixed assets not brought into the books.

Under-capitalisation causes the following **implications**:

- (a) The dividend rate will be higher in comparison to similarly situated companies.
- (b) Market value of shares will be higher than value of shares of other similar companies because their earning rate is considerably more than the prevailing rate on such securities.
- (c) Real value of shares will be higher than their book value.

Under-capitalisation has the following **effects**:

- (a) It encourages acute competition. High profitability encourages new entrepreneurs to come into same type of business.





- (b) High rate of dividend encourages the workers' union to demand high wages.
- (c) Normally common people (consumers) start feeling that they are being exploited.
- (d) Management may resort to manipulation of share values.
- (e) Invite more government control and regulation on the company and higher taxation.

Following **steps** may be taken to avoid the negative consequences of under-capitalisation:

- (a) The shares of the company should be split up. This will reduce dividend per share, though EPS shall remain unchanged.
- (b) Issue of Bonus Shares is the most appropriate measure as this will reduce both dividend per share and the average rate of earning.
- (c) The par value of shares may be revised upward in exchange of the existing shares held by them.

From the above, it may be concluded that both over capitalisation and under capitalisation are not good. However, over capitalisation is more dangerous to the company, shareholders and the society than under capitalisation. The situation of under capitalisation can be handled more easily than the situation of over-capitalisation. Moreover, under capitalisation is not an economic problem but a problem of adjusting capital structure. But both situations are bad and every company should strive to have a proper capitalisation.

#### Illustration: 43

Calculate the Degree of Operating Leverage (DOL), Degree of Financial Leverage (DFL) and the Degree of Combined Leverage (DCL) for the following firms and interpret the results.

	Firm K	Firm L	Firm M
1. Output (Units)	60,000	15,000	1,00,000
2. Fixed costs (₹)	7,000	14,000	1,500
3. Variable cost per unit (₹)	0.20	1.50	0.02
4. Interest on borrowed funds (₹)	4,000	8,000	—
5. Selling price per unit (₹)	0.60	5.00	0.10

#### Solution:

X	Firm K	Firm L	Firm M
Output (Units)	60,000	15,000	1,00,000
Selling Price per unit (₹)	0.60	5.00	0.10
Variable Cost per unit	0.20	1.50	0.02
Contribution per unit (₹)	0.40	3.50	0.08
Total Contribution (Unit × Contribution per unit) (₹)	₹ 24,000	₹ 52,500	₹ 8,000
Less: Fixed Costs (₹)	7,000	14,000	1,500
EBIT (₹)	17,000	38,500	6,500
Less : Interest (₹)	4,000	8,000	—
Profit before Tax (P.B.T.) (₹)	13,000	30,500	6,500
Degree of Operating Leverage = $\frac{\text{Contribution}}{\text{EBIT}}$	$\frac{24,000}{17,000}$	$\frac{52,500}{38,500}$	$\frac{8,000}{6,500}$
	=1.41	=1.38	=1.23



Degree of Financial Leverage = $\frac{\text{EBIT}}{\text{PBT}}$	$\frac{17,000}{13,000}$	$\frac{38,500}{30,500}$	$\frac{6,500}{6,500}$
	=1.31	=1.26	=1.00
Degree of Combined Leverage = $\frac{\text{Contribution}}{\text{PBT}}$	$\frac{24,000}{13,000}$	$\frac{52,500}{30,500}$	$\frac{8,000}{6,500}$
	=1.85	=1.72	= 1.23

**Interpretation:**

High operating leverage combined with high financial leverage represents risky situation. Low operating leverage combined with low financial leverage will constitute an ideal situation. Therefore, firm M is less risky because it has low fixed cost and low interest and consequently low combined leverage.

**Illustration: 44**

A firm has sales of ₹ 10,00,000, variable cost of ₹ 7,00,000 and fixed costs of ₹ 2,00,000 and debt of ₹ 5,00,000 at 10% rate of interest. What are the operating, financial and combined leverages? If the firm wants to double its Earnings before interest and tax (EBIT), how much of a rise in sales would be needed on a percentage basis?

**Solution:****Statement of Existing Profit**

Sales	₹ 10,00,000
Less : Variable Cost	7,00,000
Contribution	3,00,000
Less : Fixed Cost	2,00,000
EBIT	1,00,000
Less : Interest @ 10% on 5,00,000	50,000
Profit before tax (PBT)	50,000

$$\text{Operating Leverage} = \frac{\text{Contribution}}{\text{EPBT}} = \frac{3,00,000}{1,00,000} = 3$$

$$\text{Financial Leverage} = \frac{\text{EBIT}}{\text{PBT}} = \frac{1,00,000}{50,000} = 2$$

$$\text{Combined Leverage} = \frac{\text{Contribution}}{\text{PBT}} = \frac{3,00,000}{50,000} = 6$$

**Statement of Sales needed to double the EBIT**

Operating leverage is 3 times i.e., 33-1/3% increase in sales volume cause a 100% increase in operating profit or EBIT. Thus, at the sales of ₹13,33,333, operating profit or EBIT will become ₹2,00,000 i.e., double the existing one.



**Verification**

Sales	₹ 13,33,333
Variable Cost (70%)	9,33,333
Contribution	4,00,000
Fixed Costs	2,00,000
EBIT	2,00,000

**Illustration: 45**

X Corporation has estimated that for a new product its break-even point is 2,000 units if the items are sold for ₹14 per unit; the Cost Accounting department has currently identified variable cost of ₹9 per unit. Calculate the degree of operating leverage for sales volume of 2,500 units and 3,000 units. What do you infer from the degree of operating leverage at the sales volumes of 2,500 units and 3,000 units and their difference if any?

**Solution:**

**Statement of Operating Leverage**

₹

Particulars	2,500 Units	3,000 Units
Sales @ ₹ 14 per unit	35,000	42,000
Variable cost @ ₹ 9 per unit	22,500	27,000
Contribution	12,500	15,000
Fixed cost ₹ [2,000 × (14 - 9)]	10,000	10,000
EBIT	2,500	5,000
Operating Leverage = $\frac{\text{Contribution}}{\text{PBT}}$	$\frac{12,500}{2,500}$	$\frac{15,000}{5,000}$
Operating Leverage	5	3

At the sales volume of 3000 units, the operating profit is ₹ 5,000 which is double the operating profit of ₹ 2,500 (sales volume of 2,500 units) because of the fact that the operating leverage is 5 times at the sales volume of 2,500 units. Hence increase of 20% in sales volume, the operating profit has increased by 100% i.e., 5 times of 20%. At the level of 3,000 units, the operating leverage is 3 times. If there is change in sales from the level of 3,000 units, the % increase in EBIT would be three times that of % increase in sales volume.

**Illustration: 46**

The following information is available for PKJ & Co.

	(₹)
EBIT	11,20,000
Profit before Tax	3,20,000
Fixed costs	7,00,000

Calculate % change in EPS if the sales are expected to increase by 5%.

**Solution:**

In order to find out the % change in EPS as a result of % change in sales, the combined leverage should be calculated as follows:

$$\text{Operating Leverage} = \text{Contribution/EBIT} = \frac{\text{₹ } 11,20,000 + \text{₹ } 7,00,000}{11,20,000} = 1.625$$

$$\text{Financial Leverage} = \text{EBIT/Profit before Tax} = \frac{\text{₹ } 11,20,000}{3,20,000} = 3.5$$

$$\text{Combined Leverage} = \text{Contribution/Profit before tax} = \text{OL} \times \text{FL} = 1.625 \times 3.5 = 5.69.$$

The combined leverage of 5.69 implies that for 1% change in sales level, the % change in EPS would be 5.69%. So, if the sales are expected to increase by 5%, then the % increase in EPS would be  $5 \times 5.69 = 28.45\%$ .

**Illustration: 47**

XYZ and Co. has three financial plans before it, Plan I, Plan II and Plan III. Calculate operating and financial leverage for the firm on the basis of the following information and also find out the highest and lowest value of combined leverage:

Production	800 Units
Selling Price per unit	₹ 15
Variable cost per unit	₹ 10
Fixed Cost : Situation A	₹ 1,000
Situation B	₹ 2,000
Situation C	₹ 3,000

Capital Structure	Plan I	Plan II	Plan III
Equity Capital	₹ 5,000	₹ 7,500	₹ 2,500
12% Debt	5,000	2,500	7,500

**Solution:****Calculation of Operating Leverage:**

	Situation A (₹)	Situation B (₹)	Situation C (₹)
Number of unit sold	800	800	800
Sales @ ₹ 15	12,000	12,000	12,000
Variable cost @ ₹ 10	8,000	8,000	8,000
Contribution	4,000	4,000	4,000
Fixed cost	1,000	2,000	3,000
EBIT	3,000	2,000	1,000
Operating Leverage	1.33	2.00	4.00
Contribution/EBIT			



### Calculation of Financial Leverage

	Plan I (₹)	Plan II (₹)	Plan III (₹)
<b>Situation A</b>			
EBIT	3,000	3,000	3,000
Less : Interest @ 12%	600	300	900
Profit before Tax	2,400	2,700	2,100
Financial Leverage (EBIT/Profit before Tax)	1.25	1.11	1.43
<b>Situation B</b>			
EBIT	2,000	2,000	2,000
Less : Interest @ 12%	600	300	900
Profit before Tax	1,400	1,700	1,100
Financial Leverage (EBIT/Profit before Tax)	1.43	1.18	1.82
<b>Situation C</b>			
EBIT	1,000	1,000	1,000
Less : Interest @ 12%	600	300	900
Profit before Tax	400	700	100
Financial Leverage (EBIT/Profit before Tax)	2.5	1.43	10.0

### Calculation of Combined Leverage:

The combined leverage may be calculated by multiplying the operating leverage and financial leverage for different combination of Situation A, B & C and the Financial Plans, I, II & III as follows:

	Situation A	Situation B	Situation C
Plan I	1.66	2.86	10
Plan II	1.47	2.36	5.72
Plan III	1.90	3.64	40

The calculation of combined leverage shows the extent of the total risk and is helpful to understand the variability of EPS as a consequence of change in sales levels. In this case, the highest combined leverages is there when financial plan III is implemented in situation C; and lowest value of combined leverage is attained when financial plan II is implemented in situation A.

### Illustration: 48

The selected financial data for A, B and C companies for the year ended March, 2016 are as follows:

Particulars	A	B	C
Variable expenses as a % Sales	66.67	75	50
Interest	₹ 200	₹ 300	₹ 1,000
Degree of Operating leverage	5 : 1	6 : 1	2 : 1
Degree of Financial leverage	3 : 1	4 : 1	2 : 1
Income tax rate	50%	50%	50%

Prepare Income Statements for A, B and C companies.

**Solution:**

The information regarding the operating leverage and financial leverage may be interpreted as follows—For Company A, the DFL is 3 : 1 (i.e., EBIT : PBT) and it means that out of EBIT of 3, the PBT is 1 and the remaining 2 is the interest component. Or, in other words, the EBIT : Interest is 3:2.

Similarly, for the operating leverage of 6:1 (i.e., Contribution : EBIT) for Company B, it means that out of Contribution of 6, the EBIT is 1 and the balance 5 is fixed costs. In other words, the Fixed costs: EBIT is 5:1. This information may be used to draw the statement of sales and profit for all the three firms as follows:

**Statement of Operating Profit and Sales**

Particulars	A	B	C
Financial leverage = (EBIT/PBT)	3 : 1	4 : 1	2 : 1
or, EBIT/Interest	3 : 2	4 : 3	2 : 1
Interest	₹ 200	₹ 300	₹ 1,000
EBIT $200 \times 3/2$ ; $300 \times 4/3$ ; $1,000 \times 2/1$	= 300	= 400	= 2,000
Operating leverage = (Cont./EBIT)	5 : 1	6 : 1	2 : 1
i.e., Fixed Exp./EBIT	4 : 1	5 : 1	1 : 1
Variable Exp. to Sales	66.67%	75%	50%
Contribution to Sales	33.33%	25%	50%
Fixed costs	$300 \times 4/1$	$400 \times 5/1$	$2,000 \times 1/1$
	= 1,200	= 2,000	= 2,000
Contribution = (Fixed cost + EBIT)	1,500	2,400	4,000
Sales	4,500	9,600	8,000

**Income Statement for the year ended 31.03.16**

Particulars	A	B	C
Sales	₹ 4,500	₹ 9,600	₹ 8,000
Variable cost	3,000	7,200	4,000
Contribution	1,500	2,400	4,000
Fixed Costs	1,200	2,000	2,000
EBIT	300	400	2,000
Interest	200	300	1,000
PBT	100	100	1,000
Tax at 50%	50	50	500
Profit after Tax (PAT)	50	50	500
Operating leverage (Cont./EBIT) =	5	6	2
Financial leverage (EBIT/PBT) =	3	4	2
Combined leverage	15	24	4



**Illustration: 49**

The following data is available for XYZ Ltd.:

Sales	₹ 2,00,000
Less : Variable cost @ 30%	60,000
Contribution	1,40,000
Less : Fixed Cost	1,00,000
EBIT	40,000
Less : Interest	5,000
Profit before tax	35,000

**Find out:**

- (a) Using the concept of financial leverage, by what percentage will the taxable income increase if EBIT increase by 6%?
- (b) Using the concept of operating leverage, by what percentage will EBIT increase if there is 10% increase in sales, and
- (c) Using the concept of leverage, by what percentage will the taxable income increase if the sales increase by 6%. Also verify results in view of the above figures.

**Solution:**

- (a) Degree of Financial Leverage :

$$DFL = EBIT/Profit\ before\ Tax = 40,000/35,000 = 1.15$$

If EBIT increase by 6%, the taxable income will increase by  $1.15 \times 6 = 6.9\%$  and it may be verified as follows:

EBIT (after 6% increase)	₹ 42,400
Less : Interest	5,000
Profit before Tax	37,400

Increase in taxable income is ₹ 2,400 i.e., 6.9% of ₹ 35,000

- (b) Degree of Operating Leverage:

$$DOL = Contribution/EBIT = 1,40,000/40,000 = 3.50$$

If Sales increase by 10%, the EBIT will increase by  $3.50 \times 10 = 35\%$  and it may be verified as follows:

Sales (after 10% increase)	₹ 2,20,000
Less : Variable Expenses @ 30%	66,000
Contribution	1,54,000
Less : Fixed cost	1,00,000
EBIT	54,000

Increase in EBIT is ₹ 14,000 i.e., 35% of ₹ 40,000.

- (c) Degree of Combined Leverage:

$$DCL = Contribution/Profit\ before\ Tax = 1,40,000/35,000 = 4$$



If Sales increases by 6%, the profit before tax will increase by  $4 \times 6 = 24\%$  and it may be verified as follows:

Sales (after 6% increase)	₹ 2,12,000
Less : Variable Expenses @ 30%	63,600
Contribution	1,48,400
Less : Fixed cost	1,00,000
EBIT	48,400
Less : Interest	5,000
Profit before Tax	43,400

Increase in Profit before tax is ₹ 8,400 i.e., 24% of ₹ 35,000.

**Illustration: 50**

(i) Find out operating leverage from the following data:

Sales	₹ 50,000
Variable Costs	60%
Fixed Costs	₹ 12,000

(ii) Find out of financial leverage from the following data:

Net Worth	₹ 25,00,000
Debt/Equity	3 : 1
Interest rate	12%
Operating Profit	₹ 20,00,000

**Solution:**

(i)

Sales	₹ 50,000
Less : Variable cost at 60%	30,000
Contribution	20,000
Less : Fixed Cost	12,000
Operating Profit	₹ 8,000

$$\text{Operating Leverage} = \frac{\text{Contribution}}{\text{Operating Profit}} = \frac{20,000}{8,000} = 2.50$$

(ii)

Net worth =	₹ 25,00,000
Debt/Equity =	3 : 1
Hence Debt =	₹ 75,00,000
EBIT	20,00,000
Less : Interest at 12% on 75,00,000	9,00,000
PBT	11,00,000





$$\text{Financial Leverage} = \frac{\text{EBIT}}{\text{PBT}} = \frac{20,00,000}{11,00,000} = 1.82$$

**Illustration: 51**

From the following, prepare Income Statements of A, B and C firms.

	Firm A	Firm B	Firm C
Financial Leverage	3 : 1	4 : 1	2 : 1
Interest	₹ 200	₹ 300	₹ 1,000
Operating Leverage	4 : 1	5 : 1	3 : 1
Variable cost as a % of sales	66.67%	75%	50%
Income-tax Rate	45%	45%	45%

**Solution:**

**Firm A**

$$\text{EBIT Financial Leverage} = \frac{\text{EBIT}}{\text{PBT}} = \frac{3}{1} \text{ or EBIT} = 3 \times \text{EBT} \dots\dots\dots (1)$$

Again EBIT-Interest = EBT

$$\text{or EBIT}-200 = \text{EBT} \dots\dots\dots (2)$$

Taking (1) and (2) we get 3 EBT-200 = EBT

$$\text{or } 2 \text{ EBT} = 200$$

$$\text{or EBT} = ₹ 100$$

$$\text{Hence EBIT} = 3\text{EBT} = ₹ 300$$

Again, the operating leverage = Contribution/EBIT = 4/1

$$\text{EBIT} = ₹ 300,$$

$$\text{Contribution} = 4 \times \text{EBIT} = ₹ 1,200$$

Now variable cost = 66.67% on sales

$$\text{Contribution} = 100 - 66.67\% \text{ i.e., } 33\frac{1}{3}\% \text{ on sales}$$

$$\text{Hence sales} = 1200 / 33\frac{1}{3}\% = ₹ 3,600.$$

Same way EBIT, EBT, Contribution and Sales for firms B and C can be worked out.

**Firm B**

$$\text{Firm B} = \frac{\text{EBIT}}{\text{PBT}} = \frac{4}{1} \text{ or EBIT} = 4\text{EBT} \dots\dots\dots(3)$$

$$\text{Again EBIT}-\text{Interest} = \text{EBT or EBIT}-300 = \text{EBT} \dots\dots(4)$$

Taking (3) and (4) we get 4EBT-300 = EBT

$$\text{or } 3\text{EBT} = 300$$

$$\text{or EBT} = ₹ 100$$

$$\text{Hence EBIT} = 4 \times \text{EBT} = ₹ 400$$



Again Operating leverage = Contribution/EBIT = 5/1

EBIT = ₹ 400, Hence Contribution = 5 × EBIT = ₹ 2,000

Now variable cost = 75% on Sales

Contribution = 100–75% i.e., 25% on Sales

Hence Sales = 2000/25% = ₹ 8,000.

### Firm C

Financial Leverage =  $\frac{\text{EBIT}}{\text{PBT}} = \frac{2}{1}$  or EBIT = 2EBT .....(5)

Again EBIT–Interest = EBT or EBIT – 1000 = EBT ... (6)

Taking (5) and (6) we get 2EBT–1000 = EBT or EBT = ₹ 1,000

Hence EBIT = 2 × EBT = ₹ 2,000

Again Operating leverage = Contribution/EBIT = 3/1

EBIT = ₹ 2,000, Hence Contribution = 3 × EBIT = ₹ 6,000

Now Variable cost = 50% on Sales

Contribution = 100 – 50 = 50% on Sales

Hence Sales = 6,000/50% = ₹ 12,000.

### Income Statement

Particulars	Firm A	Firm B	Firm C
Sales	₹ 3,600	₹ 8,000	₹ 12,000
Less : Variable Cost	2,400	6,000	6,000
Contribution	1,200	2,000	6,000
Less : Fixed cost	900	1,600	4,000
EBIT	300	400	2,000
Less : Interest	200	300	1,000
EBT	100	100	1,000
Less : Tax @ 45%	45	45	450
Profit after Tax (PAT)	55	55	550

### Illustration: 52

ABC Ltd. wants to raise ₹ 5,00,000 as additional capital. It has two mutually exclusive alternative financial plans. The current EBIT is ₹ 17,00,000 which is likely to remain unchanged. The relevant Information is –

Present Capital Structure: 3,00,000 Equity shares of ₹ 10 each and 10% Bonds of ₹ 20,00,000.

Tax Rate:	50%
Current EBIT:	₹ 17,00,000
Current EPS:	₹ 2.50
Current Market Price:	₹ 25 per share
Financial Plan I:	20,000 Equity Shares at ₹ 25 per share.
Financial Plan II:	12% Debentures of ₹ 5,00,000.



What is the indifference level of EBIT? Identify the financial break-even levels.

**Solution:**

**1. Computation of EBIT - EPS Indifference Point**

Particulars	Financial Plan I - Equity	Financial Plan II - Debt
Owner's Funds	$(3,00,000 \times 10 + 20,000 \times 25)$ = ₹ 35,00,000	$3,00,000 \times 10 = ₹ 30,00,000$
Borrowed Funds (given)	₹ 20,00,000	$20,00,000 + 5,00,000 = ₹ 25,00,000$
Total Capital Employed	₹ 55,00,000	₹ 55,00,000

Particulars	Financial Plan I	Financial Plan II
EBIT (let it be ₹X)	X	X
Less: Interest	$20,00,000 \times 10\% = ₹ 2,00,000$	$(20,00,000 \times 10\% + 5,00,000 \times 12\%) = ₹ 2,60,000$
EBT	$X - 2,00,000$	$X - 2,60,000$
Less: Tax at 50%	$\frac{1}{2}X - 1,00,000$	$\frac{1}{2}X - 1,30,000$
EAT	$\frac{1}{2}X - 1,00,000$	$\frac{1}{2}X - 1,30,000$
Number of Equity Shares	$3,00,000 + 20,000 = 3,20,000$	(given) 3,00,000
EPS	$[\frac{1}{2}X - 1,00,000] \div 3,20,000$	$[\frac{1}{2}X - 1,30,000] \div 3,00,000$

For indifference between the above alternatives, EPS should be equal. Hence, we have

$$\frac{\frac{1}{2}X - 1,00,000}{3,00,000} = \frac{\frac{1}{2}X - 1,30,000}{3,20,000}$$

On Cross Multiplication,  $15X - 30 \text{ Lakhs} = 16X - 41.6 \text{ Lakhs}$ ; or  $X = 11.6 \text{ Lakhs}$

Hence EBIT should be ₹ 11.60 Lakhs and at that level, EPS will be ₹ 1.50 under both alternatives.

**2. Computation of Financial Break-Even Point**

The Financial BEP for the two plans are --

Plan I EBIT = ₹ 2,00,000 (i.e. 10% interest on ₹ 20,00,000)

Plan II EBIT = ₹ 2,60,000 (i.e. 10% interest on ₹ 20,00,000 and 12% interest on ₹ 5,00,000)



## GLOSSARY

**Capital Structure:** Capital structure of a company refers to the composition or make-up of its capitalization and it includes all long term capital resources, viz, loans, bonds, shares and reserves. It is made up of debt and equity securities and refers to permanent financing of a firm.

**Combined Leverage:** Combined Leverage may be defined as the potential use of fixed costs, both operating and financial, which magnifies the effect of sales volume change on the earning per share of the company. Degree of combined leverage (DCL) is the ratio of percentage change in earning per share to the percentage change in sales. It indicates the effect the sales changes will have on EPS.

**Cost of Capital:** Cost of capital is the minimum rate of return that must be earned on investments, in order to meet the rate of return required by the investors. It is the discount rate applied to evaluate the firm's capital projects.

**Dividend:** Dividend is the distribution of profit among shareholders usually expressed as a percentage of paid up capital or as an amount per share.

**Dividend Discount Model:** Dividend Discount Model is a model which calculates the value of an equity share as the present value of future dividends expected from it.

**Dividend Payout Ratio:** Dividend Payout ratio indicates the percentage of a company's earnings that are paid out to the shareholders in cash. It is calculated by dividing annual cash dividends by annual earnings. It may also be calculated by dividing dividends per share by earnings per share.

**Effective Interest Rate (EIR) Method:** Effective Interest Rate is the rate that exactly discounts estimated future cash payments or receipts through the expected life of the financial asset or financial liability to the gross carrying amount of a financial asset or to the amortised cost of a financial liability.

**Financial leverage:** Financial leverage may be defined as a % increase in EPS associated with a given percentage increase in the level of EBIT.

**Leverage:** Leverage is the use of fixed assets in order to increase profitability.

**Marginal Cost of Capital:** The Marginal Cost of Capital may be defined as the cost of raising an additional rupee of capital. It is referred to as the cost incurred in raising new funds.

**Operating Leverage:** Operating Leverage is the leverage arising from fixed operating costs.

**Over- Capitalisation:** Over – capitalisation is a situation where a company has more capital than it needs or in other words assets are worth less than its issued share capital, and earnings are insufficient to pay dividend and interest.

**Stock Splits:** Stock splits means splitting one share into many, say, one share of ₹100 into 5 shares of ₹20. Stock splits is a tool used by the companies to regulate the prices of shares.

**Under-Capitalisation:** Under-capitalisation is just reverse of over-capitalisation. It is a state, when its actual capitalisation is lower than its proper capitalisation as warranted by its earning capacity.

**Weighted Average Cost of Capital (WACC):** Weighted Average Cost of Capital is the average cost of capital of the firm's existing operations. It is computed by weighing the cost of each individual source of capital (viz. debt, equity share etc.) in proportion to the total market value of the firm.



**Self Learning Questions:**

1. Define Cost of Capital. Explain its importance.
2. Explain the determinants of Capital Structure.
3. Explain Modigliani - Miller hypothesis
4. Write short notes on
  - (a) Weighted average cost of capital.
  - (b) Capital asset pricing model.
  - (c) Marginal cost of capital.
  - (d) Net income approach
  - (e) Net operating income approach
  - (f) Criticism on MM-Hypothesis
  - (g) Arbitrage process
5. Explain how the combined effects of operating and financial leverages provide the risk profile of an organisation.
6. Briefly explain the stochastic model. Also mention its limitation.
7. How financial leverage does increases the potential reward to the shareholder?
8. Write the basic propositions and the limitation of the MM approach.
9. What is the determinant of Dividend policy?
10. What is the criticism of Capital Assets Pricing Model (CAPM)?
11. What is the assumption of Walter Model?
12. Why debt is cheaper than Equity?
13. Discuss in brief about the various component of Financial Risk?
14. Explain the "Leverage used in Financial Analysis.
15. What do you understand by dividend decision? Briefly explain the factors which govern this decision.
16. Briefly explain the advantages and disadvantages of the stock dividend?

**Multiple Choice Questions:**

1. Which of the following is not an assumption of the capital asset pricing model (CAPM)?
  - (a) The capital Market is efficient
  - (b) Investor's decisions are based on a single-time period
  - (c) Investors lend or borrow at a risk-free rate of return
  - (d) Investors do not have the same expectations about the risk and return



2. Given risk-free rate of return = 5 %, market return = 10%, cost of equity = 15%  
value of beta ( $\beta$ ) is:
  - (a) 1.9
  - (b) 2.2
  - (c) 2.0
  - (d) 1.8
  
3. Which of the following cost of capital require to adjust tax?
  - (a) Cost of Equity Shares
  - (b) Cost of Retained Earnings
  - (c) Cost of Preference Shares
  - (d) Cost of Debentures
  
4. Marginal Cost of capital is the cost of:
  - (a) Additional Funds
  - (b) Additional Revenue
  - (c) Additional Interests
  - (d) None of the above
  
5. In order to calculate Weighted Average Cost of Capital, weights may be based on:
  - (a) Market Values
  - (b) Book Value
  - (c) Target Values
  - (d) Anyone
  
6. A Company's cost of capital is the average cost of:
  - (a) All borrowings
  - (b) All share capital
  - (c) All bonds and debentures
  - (d) All sources of finance
  
7. Which of the following statements is false in the context of explaining the concept of capital structure of a firm:
  - (a) It resembles the arrangements of the various parts of a building
  - (b) The relation between equity and debt
  - (c) It represents the relation between fixed assets and current assets
  - (d) Combinations of various long-terms sources



8. The assumptions of M-M hypothesis of capital structure do not include the following;
  - (a) Capital markets are imperfect
  - (b) The dividend-payout ratio is cent percent, and there is no corporate tax
  - (c) Investors have homogeneous expectations
  - (d) All firms can be classified into homogeneous risk classes
  
9. Financial Structure refer to
  - (a) All Financial resources
  - (b) Long-term funds
  - (c) Short-term funds
  - (d) None of these
  
10. An EBIT-EPS indifference analysis chart is used for
  - (a) Evaluating the effects of business risk on EPS
  - (b) Determining the impact of a change in sales on EBIT
  - (c) Examining EPS results for alternative financial plans at varying EBIT levels
  - (d) Showing the changes in EPS quality over time
  
11. The term "capital structure" means
  - (a) Shareholders' equity
  - (b) Current assets and current liabilities
  - (c) Net working capital
  - (d) Long-term debt, preferred stock, and equity shares
  
12. Market values are often used in computing the weighted average cost of capital because:
  - (a) This is simplest way to do the calculation
  - (b) This is consistent with the goal of maximising shareholder value
  - (c) This is a very common mistake.
  - (d) This is required by SEBI.
  
13. A company's optimal capital structure:
  - (a) When Cost of equity is minimum
  - (b) Is the debt-equity ratio that results in the minimum possible weighted average cost of capital
  - (c) 40 percent debt and 60 percent equity
  - (d) When the debt-equity ratio is 0 .50



14. Which one of the following is the assumption of Gordon Model?
- (a) Retention ratio, once decided upon, is constant
  - (b)  $K_e > g$
  - (c) Firm is an all equity firm
  - (d) All of the above
15. What should be the optimum Dividend pay-out ratio when  $r = 15\%$  &  $K_e = 12\%$ ?
- (a) Zero
  - (b) 100%
  - (c) 50%
  - (d) None of the above
16. Which of the following is the irrelevance theory?
- (a) Walter model
  - (b) M.M. hypothesis
  - (c) Gordon model
  - (d) Linter's model
17. If the company's D/P ratio is 60% & ROI is 16%, what should be the growth rate?
- (a) 5%
  - (b) 7%
  - (c) 9.6%
  - (d) 6.4%
18. If the shareholders prefer regular income, how does this affect the dividend decision?
- (a) It is the indicator to retain more earnings
  - (b) It will lead to payment of dividend
  - (c) It has no impact on dividend decision
  - (d) Can't say
19. Which of the following is the limitation of Linter model?
- (a) The adjustment factor is an arbitrary number and not based on any scientific criterion or methods
  - (b) This model does not offer a market price for the shares
  - (c) Both (a) & (b)
  - (d) None of the above.





20. Given Operating fixed cost ₹20,000, Sales ₹1,00,000 and P/V ratio 40%, then the operating leverage is:
- 2.50
  - 2.00
  - 2.67
  - 2.47
21. If EBIT is ₹15,00,000, interest ₹2,50,000, corporate tax 40%, then degree of financial leverage is:
- 1.41
  - 1.31
  - 1.20
  - 1.11
22. Operating Leverage is computed as:
- $\text{EBIT} \div \text{Tax}$
  - $\text{EBIT} \div \text{PBT}$
  - $\text{Contribution} \div \text{EBIT}$
  - $\text{EBIT} \div \text{interest}$
23. Financial Leverage is computed as:
- $\text{EBIT} \div \text{Sales}$
  - $\text{EBIT} \div \text{EBT}$
  - $\text{EBIT} \div \text{Variable Cost}$
  - $\text{EBIT} \div \text{Contribution}$

[Ans: (d), (c), (d), (a), (d), (d), (c), (a), (a), (c), (d), (b), (b),  
(d), (a), (b), (d), (b), (c), (b), (c), (c), (b)]

**PRACTICAL PROBLEM:**

- Calculate the cost of capital in the following cases:
  - X Ltd. issues 12% debentures of face value ₹100 each and realizes ₹95 per debentures are redeemable after 10 years at a premium of 10%.
  - Y Ltd. issues preference shares of face value ₹100 each carrying 14% Dividend and he realizes ₹92 per share. The shares are repayable after 12 years at par.

**Note:** Both companies are paying income tax at 50%

**Ans:** (i) Cost of Debentures = 6.58%; (ii) Cost of Preference Capital = 15.28%



2. Calculate the approximate cost of companies Debenture Capital, when it decides to issue 10,000 Nos. of 14% non-convertible debentures. Each of face value ₹100, at par. The debentures are redeemable at a premium of 10% after 10 years. The average realisation is expected to be ₹92 per debenture and the tax rate applicable to the company is 40%.

**Ans:** Cost of Debentures = 9.39%;

3. JKL Ltd. has the following book-value capital structure as on March, 31, 2016

Equity share capital (2,00,000 shares)	40,00,000
11.5% Preference shares	10,00,000
10% Debentures	30,00,000
	80,00,000

The equity share of the company sells for ₹ 20. It is expected that the company will pay next year a dividend of ₹ 2 per equity share, which is expected to grow at 5% p.a. forever. Assume a 35% corporate tax rate.

**Required:**

- (i) Compute weighted average cost of capital (WACC) of the company based on the existing capital structure.
- (ii) Compute the new WACC, if the company raises an additional ₹ 20 lakhs debt by issuing 12% debentures. This would result in increasing the expected equity dividend to ₹ 2.40 and leave the growth rate unchanged, but the price of equity share will fall to ₹ 10 per share.

**Ans:** (i)  $K_e = 15\%$ ;  $K_p = 11.5\%$ ;  $K_d = 6.5\%$ ; WACC = 11.38%

(ii)  $K_e = 20\%$ ;  $K_p = 11.5\%$ ;  $K_d = 6.5\%$ ;  $K_d (12\%) = 7.8\%$ ; WACC = 12.66%

4. Three companies A, B & C are in the same type of business and hence have similar operating risks. However, the capital structure of each of them is different and the following are the details:

Particulars	A	B	C
Equity share capital (Face value ₹10 per share)	4,00,000	2,50,000	5,00,000
Market value per share	15	20	12
Dividend per share	2.70	4	2.88
Debentures (face value per debenture ₹100)	Nil	1,00,000	2,50,000
Market value per debenture	-	125	80
Interest rate	-	10%	8%

Assume that the current levels of dividends are generally expected to continue indefinitely and the income-tax rate at 50%. You are required to compute the weighted average cost of capital of each company.

**Answer:**

	K (₹)	K (₹)	K (₹)
Company A	10%	-	18%
Company B	20%	4%	16.8%
Company C	24%	5%	19.25%



5. Merry Ltd. has earning before interest and taxes (EBIT) of ₹ 30,00,000 and a 40% tax rate. Its required rate of return on equity in the absence of borrowing is 18%. In the absence of personal taxes. What is the value of the company in an MM world (i) with no leverage; ii) with ₹ 40,00,000 in debt, and iii) with ₹ 70,00,000 in debt?

**Answer:**

	(₹)
(i) Value of Unlevered Company	1,00,00,000
(ii) Value of levered Company	1,16,00,000
(iii) Value of levered Company	1,28,00,000

6. Companies X and Y are identical in all respects including risk factors except for debt/equity. Company X having issued 10% debentures of ₹18 lakhs while Company Y has issued only equity. Both the companies earn 20% before interest and taxes on their total assets of ₹30 lakhs.

Assuming a tax rate of 50% and capitalisation rate of 15% for an all-equity company, compute the value of companies X and Y using i) Net Income Approach and ii) Net Operating Income Approach.

**Answer:** (i) Value of X Ltd. ₹ 32,00,000; Value of Y Ltd. ₹ 20,00,000  
 (ii) Value of X Ltd. ₹ 29,00,000; Value of Y Ltd. ₹ 20,00,000

7. MM Ltd had the following Balance Sheet as on March 31, 2016:

Liabilities and Equity	₹ (In crores)	Assets	₹ (in crores)
Equity Share Capital (one crore shares of ₹10 each)	10	Fixed Assets (Net)	25
Reserves and Surplus	2	Current Assets	15
15% Debentures	20		
Current Liabilities	8		
	40		40

The additional information given is as under:

Fixed Costs per annum (excluding interest)	₹ 8 Crores
Variable operating costs ratio	65%
Total Assets turnover ratio	2.5
Income – tax rate	40%

**Required:**

Calculate the following and comment:

- (i) Earnings per shares
- (ii) Operating Leverage
- (iii) Financial Leverage
- (iv) Combined Leverage

**Hint:** EPS ₹ 14.40, DOL 1.296, DFL 1.125, DCL 1.458



8. Annual sales of a company is ₹ 60,00,000. Sales to variable cost ratio is 150% and Fixed cost other than interest is ₹ 5,00,000 per annum. Company has 11% debentures of ₹ 30,00,000.

You are required to calculate the Operating, Financial and Combined Leverage of the company.

**Hint:** DOL 1.333, DFL 1.2821, DCL 1.7094

9. The following details of T Limited for the year ended 31st March, 2016 are given below:

Operating leverage	1.4
Combined leverage	2.8
Fixed Cost (Excluding interest)	₹ 2.04 lakhs
Sales	₹ 30.00 lakhs
12% Debentures of ₹ 100 each	₹ 21.25 lakhs
Equity Share Capital of ₹ 10 each	₹ 17.00 lakhs
Income tax rate	30%

**Required:**

- Calculate Financial Leverage
- Calculate P/V ratio and Earning Per Share (EPS)
- If the company belongs to an industry, whose assets turnover is 1.5, does it have a high or low assets leverage?
- At what level of sale the Earning before Tax (EBT) of the company will be equal to zero?

**Hint:** DFL: 2, P.V. Ratio: 23.8%, EPS: ₹ 1.05, Asset Turnover Ratio: 0.784

10. A firm has Sales of ₹40 lakhs; Variable cost of ₹25 lakhs; Fixed cost of ₹6 lakhs 10% debt of ₹30lakhs; and Equity Capital of ₹45 lakhs.

**Required:** Calculate operating and financial leverage.

**Hint:** DOL: 1.67, DFL: 1.50

11. From the following financial data of Company A and Company B: Prepare their income Statements.

	Company A	Company B
Variable Cost	56,000	60% of sales
Fixed Cost	20,000	-
Interest Expenses	12,000	9,000
Financial Leverage	5:1	-
Operating Leverage	-	4:1
Income Tax Rate	30%	30%
Sales	-	1,05,000

**Hint:** EBIT ₹ 15,000, 10,500, EAT: 2,100, 1,050



# Study Note - 10

## CAPITAL BUDGETING - INVESTMENT DECISION



This Study Note includes:

- 10.1 Capital Budgeting
- 10.2 Need of Capital Budgeting Decision
- 10.3 Significance of Capital Budgeting Decisions
- 10.4 Process of Capital Budgeting
- 10.5 Control for Capital Expenditure
- 10.6 Investment Criterion - Methods of Appraisal

### 10.1 CAPITAL BUDGETING

One of the important aspects of Financial Management is proper decision making in respect of investment of funds. Successful operation of any business depends upon the investment of resources in such a way as to bring in benefits or best possible returns from any investment. An investment can be simply defined as an expenditure in cash or its equivalent during one or more time periods in anticipation of enjoying a net inflow of cash or its equivalent in some future time period or periods. An appraisal of investment proposals is necessary to ensure that the investment of resources will bring in desired benefits in future. If the financial resources were in abundance, it would be possible to accept several investment proposals which satisfy the norms of approval or acceptability. Since resources are limited a choice has to be made among the various investment proposals by evaluating their comparative merit. It is apparent that some techniques should be followed for making appraisal of investment proposals. Capital Budgeting is one of the appraising techniques of investment decisions. Capital Budgeting is defined as the firm's decision to invest its current funds most efficiently in long term activities in anticipation of an expected flow of future benefits over a series of years. It should be remembered that the investment proposal is common both for fixed assets and current assets.

Capital budgeting decision may be defined as "Firms decisions to invest its current funds most efficiently in long term activities in anticipation of an expected flow of future benefits over a series of year. The firm's capital budgeting decisions will include addition, disposition, modification and replacement of fixed assets".

#### Definitions:

#### Capital Expenditure

Capital Expenditure is the expenditure on fixed assets or additions thereto intended to benefit future accounting periods or expenditure which increases the capacity, efficiency, life span, or economy of operation of an existing fixed asset.

#### Capital Expenditure Budget

Capital Expenditure Budget is a plan for capital expenditure in monetary terms.

#### Capital Expenditure Budgeting

Capital Expenditure Budgeting is the process of analysing, appraising, and deciding about capital projects.

Charles. T. Horngreen defined capital budgeting as "Long term planning for making and financing proposed capital out lay".



According to Keller and Ferrara, "Capital Budgeting represents the plans for the appropriation and expenditure for fixed asset during the budget period".

Robert N. Anthony defined as "Capital Budget is essentially a list of what management believes to be worthwhile projects for the acquisition of new capital assets together with the estimated cost of each product".

## 10.2 NEED OF CAPITAL BUDGETING DECISION

The selection of the most profitable project of capital investment is the key function of Financial Manager. The decisions taken by the management in this area affect the operations of the firm for many years. Capital budgeting decisions may be generally needed for the following purposes:

(a) Expansion; (b) Replacement; (c) Diversification; (d) Buy or lease and (e) Research and Development.

**(a) Expansion:** The firm requires additional funds to invest in fixed assets when it intends to expand the production facilities in view of the increase in demand for their product in near future. Accordingly the current assets will increase. In case of expansion the existing infrastructure – like plant, machinery and other fixed assets is inadequate, to carry out the increased production volume. Thus the firm needs funds for such project. This will include not only expenditure on fixed assets (infrastructure) but also an increase in working capital (current assets).

**(b) Replacement:** The machines and equipment used in production may either wear out or may be rendered obsolete due to new technology. The productive capacity and competitive ability of the firm may be adversely affected. The firm needs funds or modernisation of a certain machines or for renovation of the entire plant etc., to make them more efficient and productive. Modernization and renovation will be a substitute for total replacement, where renovation or modernization is not desirable or feasible, funds will be needed for replacement.

**(c) Diversification:** If the management of the firm decided to diversify its production into other lines by adding a new line to its original line, the process of diversification would require large funds for long-term investment. For example ITC and Philips company for their diversification.

**(d) Buy or Lease:** This is a most important decision area in Financial Management whether the firm acquire the desired equipment and building on lease or buy it". If the asset is acquired on lease, there have to be made a series of annual or monthly rental payments. If the asset is purchased, there will be a large initial commitment of funds, but not further payments. The decision – making area is which course of action will be better to follow? The costs and benefits of the two alternative methods should be matched and compared to arrive at a conclusion.

**(e) Research and Development:** The existing production and operations can be improved by the application of new and more sophisticated production and operations management techniques. New technology can be borrowed or developed in the laboratories. There is a greater need of funds for continuous research and development of new technology for future benefits or returns from such investments.

## 10.3 SIGNIFICANCE OF CAPITAL BUDGETING DECISIONS

Capital Budgeting decisions are considered important for a variety of reasons. Some of them are the following:

1. **Crucial decisions:** Capital budgeting decisions are crucial, affecting all the departments of the firm. So the capital budgeting decisions should be taken very carefully.
2. **Long-run decisions:** The implications of capital budgeting decisions extend to a longer period in the future. The consequences of a wrong decision will be disastrous for the survival of the firm.



3. **Large amount of funds:** Capital budgeting decisions involve spending large amount of funds. As such proper care should be exercised to see that these funds are invested in productive purchases.
4. **Rigid:** Capital budgeting decision cannot be altered easily to suit the purpose. Because of this reason, when once funds are committed in a project, they are to be continued till the end, loss or profit no matter.

#### 10.4 PROCESS OF CAPITAL BUDGETING

The major steps in the capital budgeting process are given below. They are (a) Generation of project; (b) Evaluation of the project; (c) Selection of the project and (d) Execution of the project. The capital budgeting process may include a few more steps. As each step is significant they are usually taken by top management.

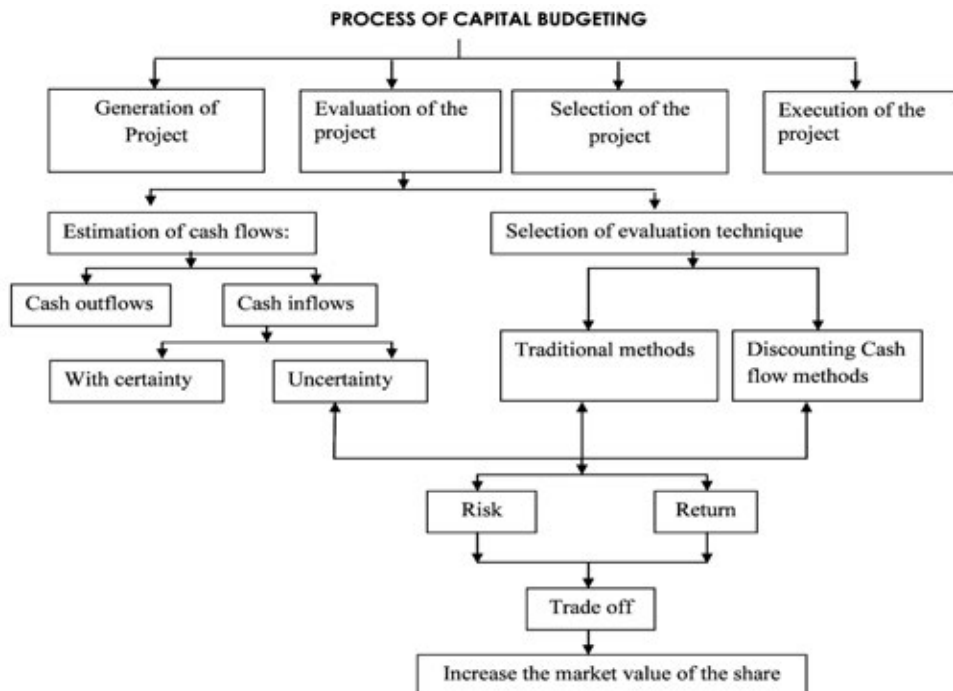

- (a) **Generation of Project:** Depending upon the nature of the firm, investment proposals can emanate from a variety of sources. Projects may be classified into five categories.
- (i) New products or expansion of existing products.
  - (ii) Replacement of equipment or buildings.
  - (iii) Research and development.
  - (iv) Exploration.
  - (v) Others like acquisition of a pollution control device etc.

Investment proposals should be generated for the productive employment of firm's funds. However, a systematic procedure must be evolved for generating profitable proposals to keep the firm healthy.

- (b) **Evaluation of the project:** The evaluation of the project may be done in two steps. First the costs and benefits of the project are estimated in terms of cash flows and secondly the desirability of the



project is judged by an appropriate criterion. It is important that the project must be evaluated without any prejudice on the part of the individual. While selecting a criterion to judge the desirability of the project, due consideration must be given to the market value of the firm.

- (c) **Selection of the project:** After evaluation of the project, the project with highest return should be selected. There is no hard and fast rule set for the purpose of selecting a project from many alternative projects. Normally the projects are screened at various levels. However, the final selection of the project vests with the top level management.
- (d) **Execution of project:** After selection of a project, the next step in capital budgeting process is to implement the project. Thus the funds are appropriated for capital expenditures. The funds are spent in accordance with appropriations made in the capital budget funds for the purpose of project execution should be spent only after seeking format permission for the controller. The follow – up comparison of actual performance with original estimates ensure better control.

Thus the top management should follow the above procedure before taking a capital expenditure decision.

### 10.5 CONTROL FOR CAPITAL EXPENDITURE

Capital expenditures are inevitably reflected in the company's operations—either in sales or in costs. Thus, capital expenditure budget is integrated with the operating budgets. The control for capital expenditures involves the following steps:

1. A creative search for investment opportunities
2. Long range plans and projections for the company's future development
3. A short range budget for supply of funds and required capital
4. A correct yardstick of economic growth
5. Realistic estimation of economic worth of individual projects
6. Standards for screening investment proposals
7. Expenditure control of outlays for facilities by comparison of authorisations and specifications
8. Post-completion audit of project earnings or post-completion project review
9. Investment analysis of facilities available
10. Forms and procedures to ensuring smooth working of the system

### 10.6 INVESTMENT CRITERION - METHODS OF APPRAISAL

The capital budgeting appraisal methods or techniques for evaluation of investment proposals will help the company to decide the desirability of an investment proposal, depending upon their relative income generating capacity and rank them in order if their desirability. These methods provide the company a set of normal method should enable to measure the real worth of the investment proposal. The appraisal methods should posses several good characteristics, which are mentioned as under.

Characteristics of a sound Appraisal Method

- (i) It should help the company to rank the investment proposals in order of their desirability.
- (ii) It should provide a technique for distinguishing between an acceptable and non-acceptable project.
- (iii) It should provide a criteria to solve the problem of choosing among alternative projects.





- (iv) It should recognize the importance of time value of money i.e. bigger benefits are preferable to smaller ones and early benefits are preferable to later benefits.
- (v) It should provide the criteria for the selection of investment proposals.
- (vi) It should take into account the pattern of cash flows.

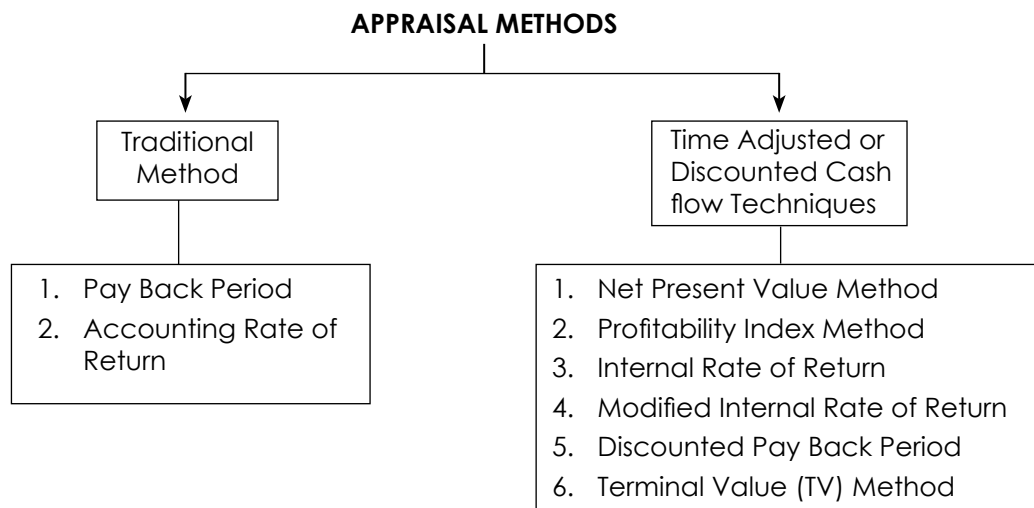

### TRADITIONAL METHODS

These methods are based on the principles to determine the desirability of an investment project on the basis of its useful life and expected returns. These methods depend upon the accounting information available from the books of accounts of the company. These will not take into account the concept of 'time value of money' which is a significant factor to desirability of a project in terms of present value.

#### 1. Pay-back Period

It is the most popular and widely recognized traditional methods of evaluating the investment proposals. It can be defined as "the number of years to recover the original capital invested in a project". According to Weston and Brigham, "the payback period is the number of years it takes for the firm to recover its original investment by net returns before depreciation, but after taxes:

- (a) **When cash flows are uniform:** If the proposed project's cash inflows are uniform the following formula can be used to calculate the payback period.

$$\text{Payback period} = \frac{\text{Initial Investment}}{\text{Annual Cash inflows}}$$

- (b) **When cash flows are not uniform**

When the project's cash inflows are not uniform, but vary from year to year pay back period is calculated by the process of cumulating cash inflows till the time when cumulative cash flows become equal to the original investment outlay.

The payback period can be used as an accept or reject criterion as well as a method of ranking projects. The payback period is the number of years to recover the investment made in a project. If the payback period calculated for a project is less than the maximum payback period set-up by the company, it can be accepted. As a ranking method it gives the highest rank to a project which has the lowest payback period, and the lowest rank to a project with the highest payback period. Whenever a company faces the problem of choosing among two or more mutually exclusive projects, it can select a project on the basis of payback period, which has shorter period than the other projects.



**Merits:** The following are the merits of the payback period method:

- (i) Easy to calculate: It is one of the easiest methods of evaluating the investment projects. It is simple to understand and easy to compute.
- (ii) Knowledge: The knowledge of payback period is useful in decision-making, the shorter the period better the project.
- (iii) Protection from loss due to obsolescence: This method is very suitable to such industries where mechanical and technical changes are routine practice and hence, shorter payback period practice avoids such losses.
- (iv) Easily availability of information: It can be computed on the basis of accounting information, what is available from the books.

**Demerits:** However, the payback period method has certain demerits:

- (i) Failure in taking cash flows after payback period: This methods is not taking into account the cash flows received by the company after the payback period.
- (i) Not considering the time value of money: It does not take into account the time value of money.
- (iii) Non-considering of interest factor: It does not take into account the interest factor involved in the capital outlay.
- (iv) Maximisation of market value not possible: It is not consistent with the objective of maximizing the market value of share.
- (v) Failure in taking magnitude and timing of cash inflows: It fails to consider the pattern of cash inflows i.e. the magnitude and timing of cash inflows.

**Illustration: 1**

A project requires an outlay of ₹50,000 and yields an annual cash inflow of ₹12,500 for 7 years. Find out the payback period.

**Solution:**

$$\text{Payback period} = \frac{\text{₹}50,000}{\text{₹}12,500} = 4 \text{ years}$$

In the case of unequal cash inflows, the payback can be found out by adding up the cash inflows until the total is equal to the initial cash outlay.

**Illustration: 2**

A project requires a cash outlay of ₹20,000, and generates cash inflows of ₹8,000, ₹ 7,000, ₹ 4,000 and ₹ 3,000 during the next 4 years. Find out the payback period of the project.

**Solution:**

Let us add up the cash inflows:

1st year	=	8,000
2nd year	=	7,000
3rd year	=	<u>4,000</u>
Total		19,000



We find that in the first 3 years ₹ 19,000 of original cash outlay is recovered. In the 4th year, cash inflow generated is ₹3,000, whereas only ₹1,000 (i.e. 20,000 - 19,000) of the original outlay remains to be recovered.

So the time required to recover ₹1,000 =  $\frac{₹1,000 \times 12 \text{ months}}{₹3,000} = 4 \text{ months}$

Therefore, Payback Period = 3 years + 4 months = 3 years 4 months

Acceptance rules of payback period:

1. Accept the project if PB < Standard payback period
2. Reject the project if PB > Standard payback period

### Accounting Rate of Return (ARR)

This method uses accounting information as revealed by the financial statements, to measure the profitability of an investment project. The ARR is found out by dividing the average post-tax profit by the average investment.

This technique uses the accounting information revealed by the financial statements to measure the profitability of an investment proposal. It can be determined by dividing the average income after taxes by the average investment. According to Solomon, Accounting Rate of Return can be calculated as the ratio, of average net income to the initial investment.

On the basis of this method, the company can select all those projects whose ARR is higher than the minimum rate established by the company. It can reject the projects with an ARR lower than the expected rate of return. This method also helps the management to rank the proposal on the basis of ARR.

Accounting Rate of Return (ARR) =  $\frac{\text{Original Investment}}{\text{Average Net Income}}$

OR

Accounting Rate of Return (ARR) =  $\frac{\text{Average Investment}}{\text{Average Net Income}}$

### Acceptance Rule

The project which gives the highest rate of return over the minimum required rate of return is acceptable

### Merits

The following are the merits of ARR method:

- (i) It is very simple to understand and calculate;
- (ii) It can be readily computed with the help of the available accounting data;
- (iii) It uses the entire stream of earnings to calculate the ARR.

### Demerits

This method has the following demerits:

- (i) It is not based on cash flows generated by a project;
- (ii) This method does not consider the objective of wealth maximization;
- (iii) It ignore the length of the projects useful life;
- (iv) It does not take into account the fact that the profit can be re-invested; and
- (v) It ignores the time value of money.

**Illustration: 3**

A project will cost ₹40,000. Its stream of earnings before depreciation, interest and taxes (EBDIT) during the 1st year through 5 years is expected to be ₹10,000, ₹ 12,000, ₹ 14,000, ₹ 16,000, and ₹20,000. Assuming a tax rate of 50% and depreciation @ 20% on straight line basis, find out the project's ARR?

**Solution:**

(Fig. in ₹)

Period	1st year	2nd year	3rd year	4th year	5th year	Average
EBDIT	10,000	12,000	14,000	16,000	20,000	14,400
Less: Depreciation @ 20%	8,000	8,000	8,000	8,000	8,000	8,000
EBIT	2,000	4,000	6,000	8,000	12,000	6,400
Less: Taxes @ 50%	1,000	2,000	3,000	4,000	6,000	3,200
Earnings before interest	1,000	2,000	3,000	4,000	6,000	3,200
Book value of investment						
Beginning	40,000	32,000	24,000	16,000	8,000	
Ending	32,000	24,000	16,000	8,000	—	
Total	72,000	56,000	40,000	24,000	8,000	
Average investment	36,000	28,000	20,000	12,000	4,000	20,000

$$\text{ARR} = \frac{3,200 \times 100}{20,000} = 16\%$$

By applying the formula we can solve this example:

$$\text{ARR} = \frac{[\sum \text{EBIT} (1 - T) / n]}{(I_1 + I_n) / 2} = 16\%$$

$$= \frac{[32,000 (1 - 0.5) / 5]}{(40,000 + 0) / 2}$$

$$= \frac{16,000 / 5}{20,000}$$

$$= \frac{3,200 \times 100}{20,000} = 16\%$$

Acceptance rules of ARR:

- (i) Accept the project if  $\text{ARR} > \text{Minimum rate of return}$
- (ii) Reject the project if  $\text{ARR} < \text{Minimum rate of return}$
- (iii) Project may be accepted if  $\text{ARR} = \text{Minimum rate of return}$



## Discounted Cash Flow Techniques

Discounted Cash Flow (DCF) is one of the methods of investment project evaluation and selection that adjusts cash flows over time for the time value of money.

The discounted cash flow methods provide a more objective basis for evaluating and selecting an investment project. These methods consider the magnitude and timing of cash flows in each period of a project's life. Discounted Cash Flows methods enable us to isolate the differences in the timing of cash flows of the project by discounting them to know the present value. The present value can be analysed to determine the desirability of the project. These techniques adjust the cash flows over the life of a project for the time value of money.

Various discounted cash flows techniques are:

- (a) Net Present Value
- (b) Profitability Index
- (c) Internal Rate of Return, and
- (d) Modified Internal Rate of Return
- (e) Discounted PB Method
- (f) Terminal Value Method

## Time Value of Money

The value of money received today is more than the value of money received after some time in the future due to the following reasons:

- (i) **Inflation:** Under inflationary conditions the value of money expressed in terms of its purchasing power over goods and services declines.
- (ii) **Risk:** Having one rupee now is certain where as one rupee receivable tomorrow is less certain. That is a bird-in-the-hand principle is most important in the investment decisions.
- (iii) **Personal Consumption Preference:** Many individuals have a strong preference for immediate rather than delayed consumption. The promise of a bowl of rice next week counts for little to the starving man.
- (iv) **Investment Opportunities:** Money like any other commodity has a price. Given the choice of ₹ 1000 now or the same amount in one year time, it is always preferable to take ₹ 1000 now, because it could be invested over the next year @ 12% interest, to produce ₹ 1,120 at the end of year. If the risk-free rate of return is 12%, then you would be indifferent in receiving ₹ 1000 now or ₹ 1,120 in one year's time. In other words, the present value of ₹ 1,120 receivable one year hence is ₹ 1000.

## Present Value

Present Value is the current value of a future amount of money or a series of cash flows, calculated at a given interest rate. The value of a firm depends upon the net cash inflows generated by the firm assets and also on future returns. The amount of cash inflows and risk associated with the uncertainty of future returns forms the basis of valuation. To get the present value, cash inflows are to be discounted at the required rate of return i.e., minimum rate expected by the investor to account for their timing and risk. The cash inflows and outflows of an investment decision are to be compared at zero time period or at the same value by discounting them at required rate of return. The following formula can be used to discount the future inflows of a project to compare with its cash outflows.



$$1 = \frac{C_1}{(1+K)^1} + \frac{C_2}{(1+K)^2} + \frac{C_3}{(1+K)^3} + \dots + \frac{C_n}{(1+K)^n}$$

Where  $V_0$  = Present value of cash inflows of the project during its life time

$C_1, C_2, \dots, C_n$  = Expected cash inflows of the project during its life time

K = Discount rate

n = Expected life of the project

### 1. Net Present Value (NPV)

Net Present Value (NPV) Method is a process of calculating the present value of a project's cash flows, using the opportunity cost of capital as the discount rate, and finding out the net present value by subtracting the initial investment from the present value of cash flows. The net present value method is a classic method of evaluating the investment proposals. It is one of the methods of discounted cash flow techniques, which recognizes the importance of time value of money. It correctly postulates that cash flows arising at time periods differ in value and are comparable only with their equivalents i.e. present values.

It is a method of calculating the present value of cash flows (inflows and outflows) of an investment proposal using the cost of capital as an appropriate discounting rate. The net present value will be arrived at by subtracting the present value of cash outflows from the present value of cash inflows. According to Ezra Solomon, "it is a present value of the cost of the investment."

**Steps** to compute net present value:

- (i) Estimation of future cash inflows
- (ii) An appropriate rate of interest should be selected to discount the cash flows. Generally, this will be the "cost of capital" of the company, or required rate of return.
- (iii) The present value of inflows and outflows of an investment proposal has to be computed by discounting them with an appropriate cost of capital.
- (iv) The net value is the difference between the present value of cash inflows and the present value of cash outflows.

The formula for the net present value can be written as:

$$NPV = \frac{C_1}{(1+K)^1} + \frac{C_2}{(1+K)^2} + \frac{C_3}{(1+K)^3} + \dots + \frac{C_n}{(1+K)^n} - I$$

Where

C = Annual Cash inflows,

$C_n$  = Cash inflow in the year n

K = Cost of Capital

I = Initial Investment



### Acceptance Rule

If the NPV is positive or atleast equal to zero, the project can be accepted. If it is negative, the proposal can be rejected. Among the various alternatives, the project which gives the highest positive NPV should be selected.

NPV is positive = Cash inflows are generated at a rate higher than the minimum required by the firm.

NPV is zero = Cash inflows are generated at a rate equal to the minimum required.

NPV is negative = Cash inflows are generated at a rate lower than the minimum required by the firm.

The market value per share will increase if the project with positive NPV is selected.

The accept/reject criterion under the NPV method can also be put as:

NPV > Zero Accept

NPV < Zero Reject

NPV = 0 May accept or reject

**Merits:** The following are the merits of the net present value (NPV) methods:

- (i) **Consideration to total Cash Inflows:** The NPV methods considers the total cash inflows of investment opportunities over the entire life-time of the projects unlike the payback period methods.
- (ii) **Recognition to the Time Value of Money:** This methods explicitly recognizes the time value of money, which is investable for making meaningful financial decisions.
- (iii) **Changing Discount Rate:** Due to change in the risk pattern of the investor different discount rates can be used.
- (iv) **Best decision criteria for Mutually Exclusive Projects:** This Method is particularly useful for the selection of mutually exclusive projects. It serves as the best decision criteria for mutually exclusive choice proposals.
- (v) **Maximisation of the Shareholders Wealth:** Finally, the NPV method is instrumental in achieving the objective of the maximization of the shareholders' wealth. This method is logically consistent with the company's objective of maximizing shareholders' wealth in terms of maximizing market value of shares, and theoretically correct for the selections of investment proposals.

**Demerits:** The following are the demerits of the net present value method:

- (i) It is difficult to understand and use.
- (ii) The NPV is calculated by using the cost of capital as a discount rate. But the concept of cost of capital itself is difficult to understand and determine.
- (iii) It does not give solutions when the comparable projects are involved in different amounts of investment.
- (iv) It does not give correct answer to a question when alternative projects of limited funds are available, with unequal lives.

### Illustration: 4

The project X costs ₹2,500 now, and is expected to generate yearend cash inflows of ₹900, ₹800, ₹ 700, ₹600, and ₹ 500 in years 1 to 5. The opportunity cost of capital is assumed to be 10%.

Find out the NPV of the project taking the discounting rate of ₹1 as follows:

1st year = ₹ 1 = 0.909

2nd year = ₹ 1 = 0.826



3rd year = ₹ 1 = 0.751

4th year = ₹ 1 = 0.683

5th year = ₹ 1 = 0.620

**Solution:**

$$\begin{aligned} \text{NPV} &= [900/(1.10) + 800/(1.10)^2 + 700/(1.10)^3 + 600/(1.10)^4 + 500/(1.10)^5] - 2,500 \\ &= [(900 \times 0.909) + (800 \times 0.826) + (700 \times 0.751) + (600 \times 0.683) + (500 \times 0.620)] - 2500 \\ &= 2,725 - 2,500 \\ &= (+) ₹ 225 \end{aligned}$$

Thus, the project should be accepted as its NPV is positive.

**2. Profitability Index (PI)**

Profitability Index (PI) or Benefit-Cost (B/C) Ratio is the ratio of the present value of cash inflows, at the required rate of return, to the initial cash outflow of the investment. According to Van Horne, the profitability Index of a project is "the ratio of the present value of future net cash inflows to the present value of cash outflows".

$$\text{Profitability Index} = \frac{\text{Present value of cash inflows}}{\text{Present value of cash outflows}}$$

**Decision criteria:** If the Profitability Index is greater than or equal to one, the project should be accepted otherwise reject.

**Merits**

The merits of this method are:

- (i) It takes into account the time value of money
- (ii) It helps to accept / reject investment proposal on the basis of value of the index.
- (iii) It is useful to rank the proposals on the basis of the highest /lowest value of the index.
- (iv) It takes into consideration the entire stream of cash flows generated during the life of the asset.

**Demerits**

However, this technique suffers from the following limitations:

- (i) It is somewhat difficult to compute.
- (ii) It is difficult to understand the analytical of the decision on the basis of profitability index.

**Illustration: 5**

The initial cash outlay of a project is ₹1,00,000. It can generate cash inflow of ₹40,000, ₹ 30,000, ₹50,000 and ₹20,000 in 1 through 4 years. Assuming a 10% rate of discount, find out the PI of the project. The discount rate of ₹ 1 is as follows:

1st year = ₹1 =0.909

2nd year = ₹ 1 = 0.826

3rd year = ₹1 =0.751

4th year = ₹ 1 = 0.683



**Solution:**

Present value of cash inflow =  $(40,000 \times 0.909) + (30,000 \times 0.826) + (50,000 \times 0.751)$

+  $(20,000 \times 0.683) = ₹ 1,12,350$

NPV = ₹1,12,350 – ₹ 1,00,000

= ₹ 12,350

So,  $PI = \frac{1,12,350}{1,00,000} = 1.1235$

The project should be accepted as  $PI > 1$ .

**3. Internal Rate of Return (IRR):**

Internal Rate of Return (IRR) Method is a discounted cash flow technique which takes account of the magnitude and timing of cash flows. The IRR is that discount rate which equates investment outlay with the present value of inflows received after a period of time.

IRR method follows discounted cash flow technique which takes into account the time value of money. The internal rate of return is the interest rate which equates the present value of expected future cash inflows with the initial capital outlay. In other words, it is the rate at which NPV is equal zero.

Whenever a project report is prepared, IRR is to be worked out in order to ascertain the viability of the project. This is also an important guiding factor to financial institutions and investors.

**Formula:**

$$C = \frac{A_1}{(1+r)} + \frac{A_2}{(1+r)^2} + \frac{A_3}{(1+r)^3} + \dots + \frac{A_n}{(1+r)^n}$$

Where

C = Initial Capital outlay.

$A_1, A_2, A_3$  etc. = Expected future cash inflows at the end of year 1, 2, 3 and so on.

r = Rate of interest

n = Number of years of project

In the above equation 'r' is to be solved in order to find out IRR.

**Computation of IRR**

The Internal rate of return is to be determined by trial and error method. The following steps can be used for its computation.

- (i) Compute the present value of the cash flows from an investment, by using arbitrary by selected interest rate.
- (ii) Then compare the present value so obtained with capital outlay.
- (iii) If the present value is higher than the cost, then the present value of inflows is to be determined by using higher rate.
- (iv) This procedure is to be continued until the present value of the inflows from the investment are approximately equal to its outflow.
- (v) The interest rate that bring about equality is the internal rate if return.



In order to find out the exact IRR between two near rates, the following formula is to be used.

$$IRR = L + \frac{A_1}{(1+r)} \times D$$

Where,

L = Lower rate of interest

$P_1$  = Present value at lower rate of interest

$P_2$  = Present value at higher rate of interest

$C_o$  = Cash outlay

D = Difference in rate of interest

### Acceptance Rule

If the internal rate of return exceeds the required rate of return, then the project will be accepted. If the project's IRR is less than the required rate of return, it should be rejected. In case of ranking the proposals the technique of IRR is significantly used. The projects with highest rate of return will be ranked as first compared to the lowest rate of return projects.

Thus, the IRR acceptance rules are

Accept if  $IRR > k$

Reject if  $IRR < k$

May accept or reject if  $IRR = k$

Where

K is the cost of capital.

### Merits

The following are the merits of the IRR method:

- (i) Consideration of Time of Money: It considers the time value of money.
- (ii) Consideration of total Cash Flows: It taken into account the cash flows over the entire useful life of the asset.
- (iii) Maximising of shareholders' wealth: It is in conformity with the firm's objective of maximizing owner welfare.
- (iv) Provision for risk and uncertainty: This method automatically gives weight to money values which are nearer to the present period than those which are distant from it. Conversely, in case of other methods like 'Payback Period' and 'Accounting Rate of Return', all money units are given the same weight which is unrealistic. Thus the IRR is more realistic method of project valuation. This method improves the quality of estimates reducing the uncertainty to minimum.
- (v) Elimination of pre-determined discount rate: Unlike the NPV method, the IRR method eliminates the use of the required rate of return which is usually a pre-determined rate of cost of capital for discounting the cash flow consistent with the cost of capital. Therefore, the IRR is more reliable measure of the profitability of the investment proposals.

### Demerits

The following are the demerits of the IRR:

- (i) It is very difficult to understand and use



- (ii) It involves a very complicated computational work
- (iii) It may not give unique answer in all situations.
- (iv) The assumption of re-investment of cash flows may not be possible in practice.
- (v) In evaluating the mutually exclusive proposals, this method fails to select the most profitable project which is consistent with the objective of maximization of shareholders wealthy.

The result of this method may be inconsistent compare to NPV method, if the projects differ in their (a) expected lives (b) investment or (c) timing of cash inflows.

### Illustration: 6

From the following data find out the IRR of a project:

Investment = ₹ 1,00,000

Cash flows for:

1st year = ₹ 30,000

2nd year = ₹ 30,000

3rd year = ₹40,000, and

4th year = ₹ 45,000

### Solution:

The IRR is the value of  $r$ , which satisfies the following equation:

$$1,00,000 = [30,000/(1+r) + 30,000/(1+r)^2 + 40,000/(1+r)^3 + 45,000/(1+r)^4]$$

The calculation of  $r$  involves a process of trial error. Let us see the annuity table and try

$r = 15\%$ . Applying the value of  $r$  in the above equation we get:

$$30,000/(1.15) + 30,000/(1.15)^2 + 40,000/(1.15)^3 + 45,000/(1.15)^4 = 1,00,802$$

Since 10,082 is slightly higher than 1,00,000, we may increase the value of  $r$  to 16%, and apply on the equation.

$$30,000/(1.16) + 30,000/(1.16)^2 + 40,000/(1.16)^3 + 45,000/(1.16)^4 = 98,641$$

We can conclude that the value of  $r$  is in between 15% and 16%. Now we can do the interpolation exercise by the following procedure:

*Step 1: Determine the NPV of the two close rate of return*

$$\text{Here, NPV at } 15\% = 1,00,000 - 1,00,802 = (+) 802$$

$$\text{NPV at } 16\% = 1,00,000 - 98,641 = (-) 1,359$$

*Step 2: Find the sum of the absolute values of the NPVs obtained in Step 1.*

$$\text{Here, } 802 + 1,359 = 2,161$$

*Step 3: Calculate the ratio of NPV of the smaller discount rate identified.*

$$\text{Here, } 802/2,161 = 0.37$$

*Step 4: Add the number obtained in Step 3 to the following discount rate.*

$$\text{Here, } 15 + 0.37 = 15.37\%$$



Therefore, the decision rule for IRR is as follows:

Accept the project if the IRR is greater than the cost of capital.

Reject the project if the IRR is lesser than the cost of capital.

### **Internal Rate of Return vs. Net Present Value**

#### **Comparison of both the techniques**

- (i) Both techniques use Discounted Cash Flow (DCF) method.
- (ii) Both recognize the time value of money.
- (iii) Both take into account the cash flows over the entire life of the project.
- (iv) Both are consistent with the objective of maximizing the wealth of shareholders.
- (v) Both are difficult to calculate.
- (vi) Both techniques may often give contradictory result in the case of alternative proposals which are mutually exclusive.

#### **Contrast, i.e. Points of difference**

- (i) Interest Rate: NPV uses the firm's cost of capital as Interest Rate. Unless the cost of capital is known, NPV method cannot be used. Calculating cost of capital is not required for computing IRR.
- (ii) NPV may mislead when dealing with alternative projects or limited funds under the conditions of unequal lives. IRR allows a sound comparison of the project having different lives and different timings of cash inflows.
- (iii) NPV may give different ranking in case of complicated projects as compared to IRR method.
- (iv) NPV assumes that intermediate cash flows are re-invested at firm's cost of capital whereas IRR assumes that intermediate cash inflows are reinvested at the internal rate of the project.
- (v) The results of IRR method may be inconsistent compared to NPV method, if the projects differ in their (a) expected lives or (b) investment or (c) timing of cash inflow.
- (vi) IRR method favours short-lived project so long as it promises return in excess of cut-off rate whereas NPV method favours long-lived projects.
- (vii) Sometimes IRR may give negative rate or multiple rates. NPV does not suffer from the limitation of multiple rates.

#### **Recommendation**

The NPV method is generally considered to be superior theoretically because:

- (i) It is simple to calculate as compared to IRR.
- (ii) It does not suffer from the limitation of multiple rates.
- (iii) NPV assumes that intermediate cash flows are reinvested at firm's cost of capital. The reinvestment assumption of NPV is more realistic than IRR method.

But IRR method is favoured by some scholars because:

- (i) It is easier to visualize and to interpret as compared to NPV.
- (ii) Even in the absence of cost of capital, IRR gives an idea of project's profitability.

#### **Note:**

Unless the cost of capital is known, NPV cannot be used.



(iii) IRR method is preferable to NPV in the evaluation of risky projects.

#### 4. Modified Internal Rate of Returns (MIRR)

IRR assumes that interim positive cash flows are reinvested at the rate of returns as that of the project that generated them. This is usually an unrealistic scenario. To overcome this drawback a new technique emerges. Under MIRR the earlier cash flows are reinvested at firm's rate of return and finding out the terminal value. MIRR is the rate at which present value of terminal values equal to outflow (Investment).

The procedure for calculating MIRR is as follows:

Step 1: Calculate the present value of the costs (PVC) associated with the project, using cost of capital (r) as the discount rate.

$$PVC = \sum_{t=0}^n \frac{\text{Cash outflow}_t}{(1+r)^t}$$

Step 2: Calculate the future value (FV) of the cash inflows expected from the project:

$$FV = \sum_{t=0}^n \text{Cash outflow}_t (1+r)^{n-t}$$

Step 3: Obtain MIRR by solving the following equation:

$$PVC = \frac{FV}{(1+\text{MIRR})^n} \text{ or } \text{MIRR} = \sqrt[n]{\frac{FV (\text{positive cash flows reinvestment rate})}{P (\text{negative cash flows rate})}} - 1$$

n = Numbers of periods over which cash flows Occurred

#### Illustration: 7

PQR Ltd. is evaluating a project that has the following cash flow stream associated with it.

Year	Cash flows (in ₹ lakhs)
0	(-) 120
1	(-) 80
2	20
3	60
4	80
5	100
6	120

The cost of capital for the company is 15%.

Find the Present Value of Cost (PVC). Find out also the Terminal Value (TV) of the cash inflows. Show the MIRR.

#### Solution:

$$\text{The present value of costs (PVC)} = \frac{120 + 80}{(1.15)} = 189.6$$

The Terminal Value (TV) of the cash inflows can be calculated as follows:

$$\begin{aligned} \text{TV} &= 20(1.15)^4 + 60(1.15)^3 + 80(1.15)^2 + 100(1.15) + 120 \\ &= 34.98 + 91.26 + 105.76 + 115 + 120 = 467 \end{aligned}$$



MIRR can be calculated as follows:

$$\begin{aligned} 189.6 &= 467/(1 + \text{MIRR})^6 \\ \text{or } (1 + \text{MIRR})^6 &= 467/189.6 = 2.463 \\ \text{or } 1 + \text{MIRR} &= (2.463)^{1/6} = 1.162 \\ \text{or } \text{MIRR} &= 1.162 - 1 = 0.162 \\ \text{or } \text{MIRR} &= 16.2\% \end{aligned}$$

### 5. Discounted Pay Back Method

Discounted Payback (DPB) is defined as the number of years required in recovering the cash outlay of the project on the present value basis.

Under this method the discounted cash inflows are calculated and where the discounted cash flows are equal to original investment then the period which is required is called discounting payback period. While calculating discounting cash inflows the firm's cost of capital has been used.

#### Formula:

$$\text{Discounted payback period (DPP)} = \frac{\text{Investment}}{\text{Discounted Annual cash in flow}}$$

**DECISION CRITERIA:** Out of two projects, selection should be based on the period of discounting payback period (Lesser payback period should be preferred.)

### 6. Terminal Value (TV) Method

Terminal Value (TV) is the value of an asset at some point of time in future. This method is adopted on the basis of assumptions that cash flow of each year is re-invested in another asset at a certain rate of return from the time of its receipt till the end of the economic life of the project. However, the cash flow of the last year of the project will not be re-invested. This method is also based on the assumption that the total sum of the compounded cash inflows is received at the end of the life of the project and therefore, is discounted at present values at the discounting rate. Thereafter the present values of compounded cash inflows are compared with the present values of cash outflows. Acceptance rules of TV are:

1. Accept the project if present values of compounded cash inflows > present values of cash outflows
2. Reject the project if present values of compounded cash inflows < present values of cash outflows
3. Project may be accepted if present values of compounded cash inflows = present values of cash outflows

Both NPV and TV methods are the same except with a difference that in the case of TV the values are compounded, but in the case of NPV the values are discounted.

#### Illustration: 8

Following information is available from XYZ Ltd. regarding a project:

Initial outlay ₹2,00,000

Project life 5 years

Net cash inflow ₹80,000 each of 5 years

Cost of capital @ 10%

Expected rate of interest are:



End of the year	Percentage
1	6%
2	6%
3	8%
4	8%

Evaluate the proposal using Terminal Value method.

**Solution:**

It may be noted that the 1st year's cash flow will be re-invested for 4 years, 2nd year's for 3 years and so on. Cash outflows of 5th year will not be re-invested.

Year	Cash inflows (₹)	Rates of return (%)	Period of reinvestment (yr)	Compounding factors	Compounded cash inflows (₹)
1	80,000	6%	4	1.262	1,00,960
2	80,000	6%	3	1.191	95,280
3	80,000	8%	2	1.166	93,280
4	80,000	8%	1	1.080	86,400
5	80,000	8%	0	1.000	80,000
<b>Total</b>					<b>4,55,920</b>

Now we have to find out the present value of ₹4,55,920 to be received at the end of 5th year at a discount rate of 10%.

PV factor for the 5th year at 10% is 0.621.

PV of compounded cash inflows =  $4,55,920 \times 0.621 = ₹2,83,126.32$

As ₹2,83,126.32 is more than ₹2,00,000 (i.e. initial cash outlay), the project may be accepted. Here TV = (+) 83,130 (approx.) (i.e. 2,83,130 - 2,00,000).

**Illustration: 9**

The directors of Beta Limited are contemplating the purchase of a new machine to replace a machine which has been in operation in the factory for the last 5 years.

Ignoring interest but considering tax at 50% of net earnings, suggest which of the two alternatives should be preferred. The following are the details:

	OLD MACHINE	NEW MACHINE
Purchase price	₹ 40,000	₹ 60,000
Estimated life of machine	10 years	10 years
Machine running hours per annum	2,000	2,000
Units per hour	24	36
Wages per running hour	3	5.25
Power per annum	2,000	4,500



Consumables stores per annum	6,000	7,500
All other charges per annum	8,000	9,000
Materials cost per unit	0.50	0.50
Selling price per unit	1.25	1.25

You may assume that the above information regarding sales and cost of sales will hold good throughout the economic life of each of the machines. Depreciation has to be charged according to straight-line method.

**Solution:**

**Appraisal of replacement decision under Average Rate of Return Method (ARR)**

Particulars	Existing Machine	New Machine
Cost of Machine (₹)	40,000	60,000
Life of Machine	10 years	10 Years
Machine running hours	2,000	2,000
Depreciation [40,000 / 10] [60,000 / 10](₹)	4,000	6,000
Production in units [2,000 x 24] [2000 x 36]	48,000	72,000

	(₹)	(₹)
<b>Sales [48,000 x 1.25] [72,000 x 1.25] [A]</b>	<b>60,000</b>	<b>90,000</b>
<b>Cost of sales:</b>		
Depreciation	4,000	6,000
Wages [2000 x 3] [2000 x 5.25]	6,000	10,500
Power	2,000	4,500
Consumables	6,000	7,500
Other charges	8,000	9,000
Material [48,000 x 0.50] [72,000 x 0.50]	24,000	36,000
<b>Total Cost [B]</b>	<b>50,000</b>	<b>73,500</b>
Profit Before Tax [A-B]	10,000	16,500
Less: Tax at 50%	5,000	8,250
Profit after tax	5,000	8,250

Investment	40,000	60,000
Average rate of return [On investment] = Profit after tax/original investment x 100	$\frac{5,000}{40,000} \times 100$	$\frac{8,250}{60,000} \times 100$
	= 12.5%	= 13.75%

**Comment:**

From the above computation, it is clear that new machine can be replaced in place of old machine because it has higher ARR.



**Illustration: 10**

A company has just installed a machine Model A for the manufacture of a new product at capital cost of ₹1,00,000. The annual operating costs are estimated at ₹50,000 (excluding depreciation) and these costs are estimated on the basis of an annual volume of 1,00,000 units of production. The fixed costs at this volume of 1,00,000 units of output will amount to ₹4,00,000 p.a. The selling price is ₹5 per unit of output. The machine has a five year life with no residual value.

The company has now come across another machine called Super Model which is capable of giving, the same volume of production at an estimated annual operating costs of ₹30,000 exclusive of depreciation. The fixed costs will however, remain the same in value. This machine also will have a five year life with no residual value. The capital cost of this machine is ₹1,50,000.

The company has an offer for the sale of the machine Model A (which has just been installed) at ₹50,000 and the cost of removal thereof will amount to ₹10,000. Ignore tax.

In view of the lower operating cost, the company is desirous of dismantling of the machine Model A and installing the Super Model Machine. Assume that Model A has not yet started commercial production and that the time lag in the removal thereof and the installation of the Super Model machine is not material.

The cost of capital is 14% and the P.V. Factors for each of the five years respectively are 0.877, 0.769, 0.675, 0.592 and 0.519.

State whether the company should replace Model A machine by installing the Super Model machine. Will there be any change in your decision if the Model A machine has not been installed and the company is in the process of consideration of selection of either of the two models of the machine? Present suitable statement to illustrate your answer.

**Solution:****(A) Appraisal of replacement decision under NPV method****Step 1:**

Calculation of Present value of net cash outflow or net investment required.

Cost of super model		1,50,000
Less: Sale proceeds of Model A	50,000	
(-) Cost of removal	10,000	40,000
Net investment required		1,10,000

**Step 2:**

Calculation of present value of incremental operating cash flows:

Particulars		Model A	Super Model	Incremental
Sales p.a. (units)	[a]	1,00,000	1,00,000	
Sales p.a. [₹] [1,00,000 x 5]		5,00,000	5,00,000	
Less: Expenses				
Operating cost		50,000	30,000	
Fixed cost		4,00,000	4,00,000	
<b>Total Cost</b>	<b>[b]</b>	<b>4,50,000</b>	<b>4,30,000</b>	
<b>Cash Inflows</b>	<b>[a-b]</b>	<b>50,000</b>	<b>70,000</b>	<b>20,000</b>

**Step 3:**

Present value of terminal cash inflow [Salvage value] - NIL

**Step 4:**

Calculation of NPV	(₹)
*Present value of total cash inflows* (Recurring + Salvage)	68,660
Less: Outflow	1,10,000
Net Present Value	(41,340)

**Comment:**

As net present value is negative, the replacement decision is not financially feasible.

**Working Notes:**

\* 1. Total incremental cash inflows = ₹ 20,000

Present value of incremental recurring cash inflows for 5 years

$$= 20,000 \times \text{PVAF 5 years 14\%}$$

$$= 20,000 \times 3.433$$

P.V of cash flows = ₹ 68,660

**(B) Appraisal of mutually exclusive decision under NPV method****Alternative I – Model A****Calculation of NPV under Alternative I****Step 1:**

Calculation of Present value of cash outflow Cost of machine = ₹1,00,000

**Step 2:**

Calculation of present value of recurring cash inflows or operating cash inflows

Cash inflows after tax (as above) – ₹50,000

PV of operating cash inflows for 5 years = 50,000 x PVAF 5 years 14%

$$= 50,000 \times 3.433$$

$$= ₹ 1,71,650$$

**Step 3:**

Calculation of PV of terminal cash inflows = Nil

**Step 4:**

Calculation of NPV	₹
PV of total cash inflows	= 1,71,650
Less: Outflow	= 1,00,000
Net Present Value (under alternative I)	= <b>71,650</b>

**Alternative 2:- Super Model****Calculation of NPV under Alternative II Step 1:**

Calculation of Present value of cash outflow

Cost of Machine = ₹ 1,50,000

**Step 2:**

Calculation of operating cash inflows or PV of recurring cash inflows

PV of operating cash inflows for 5 years = 70,000 x PVAF 5 years 14%

= 70,000 x 3.433

= ₹ 2,40,310

**Step 3:**

Calculation of PV of terminal cash inflow – NIL

**Step 4:**

Calculation of NPV	₹
PV of total cash inflow [2,40,310 + 0]	= 2,40,310
Less: Outflow	= 1,50,000
Net Present Value (under alternative II)	= <b>90,310</b>

**Comment:**

As NPV of Super Model is more [₹90,310] than that of Model A [₹71,650], it is advised to Select Super Model.

**Illustration: 11**

Techtronics Ltd., an existing company, is considering a new project for manufacture of pocket video games involving a capital expenditure of ₹600 lakhs and working capital of ₹150 lakhs. The capacity of the plant is for an annual production of 12 lakh units and capacity utilisation during the 6-year working life of the project is expected to be as indicated below.

Year	Capacity utilisation (%)
1	33 1/3 %
2	66 2/3 %
3	90 %
4-6	100 %

The average price per unit of the product is expected to be ₹200 netting a contribution of 40%. Annual fixed costs, excluding depreciation, are estimated to be ₹480 lakhs per annum from the third year onwards; for the first and second year it would be ₹240 lakhs and ₹360 lakhs respectively. The average rate of depreciation for tax purposes is 33 1/3% on the capital assets. No other tax reliefs are anticipated. The rate of income-tax may be taken at 50%.

At the end of the third year, an additional investment of ₹100 lakhs would be required for working capital.

The company, without taking into account the effects of financial leverage, has targeted for a rate of return of 15%.

You are required to indicate whether the proposal is viable, giving your working notes and analysis.



Terminal value for the fixed assets may be taken at 10% and for the current assets at 100%. Calculation may be rounded off to lakhs of rupees. For the purpose of your calculations, the recent amendments to tax laws with regard to balancing charge may be ignored.

**Solution:****Evaluation of Expansion decision under NPV method**

**Step 1:** ₹ In lakhs

Calculation of PV of cash outflow

Cost of fixed asset at [t<sub>0</sub>] – 600 x 1 = ₹ 600

Cost of working capital at [t<sub>0</sub>] – 150 x 1 = ₹ 150

Additional WC required at [t<sub>3</sub>] – 100 x PVF 3yrs 15% - 100 x 0.66 = ₹ 66

PV of cash outflow = ₹ 816

**Step 2:**

Calculation of PV of operating cash inflow for six years (working notes) = ₹ 826 lakhs

**Step 3:**

Calculation of PV of terminal cash inflow

Salvage value of fixed assets [600 x 10/100] = 60

Less: Tax on profit at 50% [60-53] x 50/100 = 3.5(rounded off) = 56

WC recovered [100%] [100 + 150] = 250

= 306

Its present value = 306 x PVAF 6 yrs 15% = 306 x 0.432 = ₹ 132 lakhs

**Step 4:**

Calculation of NPV

PV of total cash inflows [Recurring + Terminal i.e., 826 + 132] = ₹ 958

Less: Outflow = ₹ 816

NPV = ₹ 142 lakhs

**Comment:**

As NPV is positive, it is advised to implement the new project.

**Working Notes:****1. Calculation of Operating Cash Inflows**

Year	Production	Contribution	Fixed expenses	Depreciation (WDV)	PBT	PAT	CIAT	PV at 15%	PV
1	400	320	240	200	(120)	(60)	140	0.870	121.80
2	800	640	360	133	147	74	207	0.756	156.49
3	1080	864	480	89	295	148	237	0.658	155.95
4	1200	960	480	59	421	210	269	0.572	153.87
5	1200	960	480	40	440	220	260	0.497	129.22
6	1200	960	480	26	454	227	253	0.432	109.29
<b>PV of operating cash inflows for 6 years</b>									<b>826.62</b>

**Illustration: 12**

A chemical company is considering replacing an existing machine with one costing ₹65,000. The existing machine was originally purchased two years ago for ₹28,000 and is being depreciated by the straight line method over its seven-year life period. It can currently be sold for ₹30,000 with no removal costs. The new machine would cost ₹10,000 to install and would be depreciate over five years. The management believes that the new machine would have a salvage value of ₹5,000 at the end of year 5. The management also estimates an increase in net working capital requirement of ₹10,000 as a result of expanded operations with the new machine. The firm is taxed at a rate of 55% on normal income and 30% on capital gains. The company's expected after-tax profits for next 5 years with existing machine and with new machine are given as follows:

Year	Expected after-tax profits	
	With existing machine (₹)	With new machine (₹)
1	2,00,000	2,16,000
2	1,50,000	1,50,000
3	1,80,000	2,00,000
4	2,10,000	2,40,000
5	2,20,000	2,30,000

- (a) Calculate the net investment required by the new machine.  
 (b) If the company's cost of capital is 15%, determine whether the new machine should be purchased.

**Solution:****Appraisal of replacement decision under NPV method****Step 1:****Calculation of present value of net investment required**

	(₹)	(₹)
Cost of new asset		65,000
Add: Installation cost		10,000
		75,000
Add: Additional WC		10,000
		85,000
Less: Sale proceeds of old machine	30,000	
Less: Tax $[8,000 \times 55/100 + 2000 \times 30/100]$	5,000	25,000
Net Investment required		60,000

**Step 2:****Calculation of Present Value of Incremental Operating cash inflows for 5 years**

Year	CIAT (PAT + Dep)	New	Incremental	PV factor at 15%	Present Value
1	2,04,000	2,30,000	26,000	0.8696	22,609
2	1,54,000	1,64,000	10,000	0.7561	7,561
3	1,84,000	2,14,000	30,000	0.6575	19,725
4	2,14,000	2,54,000	40,000	0.5718	22,872
5	2,24,000	2,44,000	20,000	0.4972	9,944
<b>PV of cash inflows for 5 years</b>					<b>82,711</b>

**Step 3:****Calculation of PV of terminal cash inflow**

	(₹)
Salvage value of asset [No tax because book value and salvage value are equal]	5,000
Working capital recovered [100% recovered]	10,000
Terminal cash inflows	15,000

Its PV at the end of 5th year =  $15,000 \times 0.4972 = 7,458$

**Step 4:****Calculation of NPV**

	₹
PV of total cash inflows [82,711 + 7,458]	= 90,169
(-) Outflow	= 60,000
<b>NPV</b>	<b>= 30,169</b>

**Comment:**

As NPV is positive, it is advised to replace.

**Note 1:**

Depreciation for old Machine =  $28,000 / 7 = ₹ 4,000$

Depreciation for new Machine =  $\frac{65,000 + 10,000 - 5,000}{5} = ₹ 14,000$

**Illustration: 13**

A Company is considering two mutually exclusive projects. Project K will require an initial cash investment in machinery of ₹ 2,68,000. It is anticipated that the machinery will have a useful life of ten years at the end of which its salvage will realise ₹20,500. The project will also require an additional investment in cash, Sundry debtors and stock of ₹40,000. At the end of five years from the commencement of the project balancing equipment for ₹45,000 has to be installed to make the unit workable. The cost of additional machinery will be written off to depreciation over the balance life of the project. The project is expected to yield a net cash flow (before depreciation) of ₹1,00,000 annually.

Project R, which is the alternative one under consideration, requires an investment of ₹3,00,000 in machinery and as in Project K investment in current assets of ₹40,000. The residual salvage value of the machinery at the end of its useful life of ten years is expected to be ₹25,000. The annual cash inflow (before depreciation) from the project is worked at ₹80,000 p.a. for the first five years and ₹1,80,000 per annum for the next five years.

Depreciation is written off by the Company on sum-of-the years' digits method, (i.e., if the life of the asset is 10 years, then in the ratio of 10, 9, 8 and so on). Income tax rate is 50%. A minimum rate of return has been calculated at 16%. The present value of ₹ 1 at interest of 16% p.a. is 0.86, 0.74, 0.64, 0.55, 0.48, 0.41, 0.35, 0.30, 0.26 and 0.23 for years 1 to 10 respectively.

Which Project is better? Assuming no capital gains taxes, calculate the Net Present Value of each Project.

**Solution:****Appraisal of mutually exclusive decision under NPV method****Alternative 1: Project K****Calculation of NPV under alternative I****Step 1:****Calculation of present value of cash outflow**

	(₹)
Cost of machine at (t0) (2,68,000 x 1)	2,68,000
Additional working capital at (t0) [40,000 x 1]	40,000
PV of additional asset at (t5) [45,000 x 0.48]	21,600
<b>PV of total cash outflow</b>	<b>3,29,600</b>

**Step 2:****Calculation of PV of operating cash inflows for 10 years**

Year	Cash profit before dep.	Dep. on original asset	Dep. on additional asset	PBT	PAT at 50%	CIAT	PV factor at 16%	PV
1	1,00,000	45,000	--	55,000	27,500	72,500	0.86	62,350
2	1,00,000	40,500	--	59,500	29,750	70,250	0.74	51,985
3	1,00,000	36,000	--	64,000	32,000	68,000	0.64	43,250
4	1,00,000	31,500	--	68,500	34,250	65,750	0.55	36,163
5	1,00,000	27,000	--	73,000	36,500	63,500	0.48	30,480
6	1,00,000	22,500	15,000	62,500	31,250	68,750	0.41	28,188
7	1,00,000	18,000	12,000	70,000	35,000	65,000	0.35	22,750
8	1,00,000	13,500	9,000	77,500	38,750	61,250	0.30	18,375
9	1,00,000	9,000	6,000	85,000	42,500	57,500	0.26	14,950
10	1,00,000	4,500	3,000	92,500	46,250	53,750	0.23	12,363
								<b>3,21,123</b>

Note 1: Calculation of depreciation under sum of the years digits method:

$$\text{Depreciation} = \frac{\text{Cost of asset} - \text{Scrap}}{\text{Sum of the year}} \times 10/9/8 \dots \text{and so on}$$

$$= \frac{2,68,000 - 20,500}{55} \times 10/9/8 \dots \text{and so on}$$

1	2	3	4	5	6	7	8	9	10
4500 x 10	4500 x 9	4500 x 8	4500 x 7	4500 x 6	4500 x 5	4500 x 4	4500 x 3	4500 x 2	4500 x 1
45,000	40,500	36,000	31,500	27,000	22,500	18,000	13,500	9,000	4,500

**Note 2:** Calculation of depreciation on additional asset



$$\begin{aligned}\text{Depreciation} &= \frac{\text{Cost of asset} - \text{Scrap}}{\text{Sum of the year}} \\ &= \frac{45,000 - 0}{15} \\ &= 3,000\end{aligned}$$

6	7	8	9	10
3000 x 5	3000 x 4	3000 x 3	3000 x 2	3000 x 1
15,000	12,000	9,000	6,000	3,000

**Step 3:** Calculation of present value of terminal cash inflows:

	(₹)
Realizable value of asset	20,500
WC recovered (100%)	40,000
	60,500

Its present value = 60,500 x 0.23 = 13,915

**Step 4:**

Calculation of NPV

PV of total cash inflows [3, 22,123 + 13,915]	3,35,038
Less: outflow	3,29,600
NPV	5,438

**Alternative II – Project R**

**Calculation of NPV under alternative II**

**Step 1:**

<b>Calculation of initial investment</b>	₹
Cost of asset	= 3,00,000
(+) Working capital	= 40,000
Initial investment	= 3,40,000



**Step 2:****Calculation of PV of recurring cash inflows for 10 years**

Year	Cash profit before tax	Dep	PBT	PAT at 50%	CIAT	PV factor at 16%	PV
1	80,000	50,000	30,000	15,000	65,000	0.86	55,900
2	80,000	45,000	35,000	17,500	62,500	0.74	46,250
3	80,000	40,000	40,000	20,000	60,000	0.64	38,400
4	80,000	35,000	45,000	22,500	57,500	0.55	31,625
5	80,000	30,000	50,000	25,000	55,000	0.48	26,400
6	1,80,000	25,000	1,55,000	77,500	1,02,500	0.41	42,025
7	1,80,000	20,000	1,60,000	80,000	1,00,000	0.35	35,000
8	1,80,000	15,000	1,65,000	82,500	97,500	0.30	29,250
9	1,80,000	10,000	1,70,000	85,000	95,000	0.26	24,700
10	1,80,000	5,000	1,75,000	87,500	92,500	0.23	21,275
							<b>3,50,825</b>

**Step 3:**

Calculation of PV of terminal cash inflows	₹
Scrap value	= 25,000
WC	= 40,000
	= 65,000

Its PV = 65,000 x 0.23 = 14,950

**Step 4:**

	₹
PV of total cash inflows [3,50,825 + 14,950]	= 3,65,775
Less: Outflow	= 3,40,000
NPV	= 25,775

**Comment:**

Project R is better compared to project K because it has positive NPV.

**Illustration: 14**

A product is currently manufactured on a machine that is not fully depreciated for tax purposes and has a book value of ₹70,000. It was purchased for ₹2,10,000 twenty years ago. The cost of the product are as follows:

	Unit Cost
Direct Labour	₹ 28.00
Indirect labour	14.00
Other variable overhead	10.50
Fixed overhead	17.50
	70.00



In the past year 10,000 units were produced. It is expected that with suitable repairs the old machine can be used indefinitely in future. The repairs are expected to average ₹ 75,000 per year.

An equipment manufacturer has offered to accept the old machine as a trade in for a new equipment. The new machine would cost ₹4,20,000 before allowing for ₹1,05,000 for the old equipment. The Project costs associated with the new machine are as follows:

	Unit Cost
Direct Labour	₹14.00
Indirect labour	21.00
Other variable overhead	7.00
Fixed overhead	22.75
	64.75

The fixed overhead costs are allocations for other departments plus the depreciation of the equipment. The old machine can be sold now for ₹50,000 in the open market. The new machine has an expected life of 10 years and salvage value of ₹20,000 at that time. The current corporate income tax rate is assumed to be 50%. For tax purposes cost of the new machine and the book value of the old machine may be depreciated in 10 years. The minimum required rate is 10%. It is expected that the future demand of the product will stay at 10,000 units per year. The present value of an annuity of ₹ 1 for 9 years @ 10% discount factor = 5.759. The present value of ₹1 received at the end of 10th year @10% discount factor is = 0.386. Should the new equipment is purchased?

**Solution:**

**Evaluation of replacement decision under NPV Method**

**Step 1: Calculation of PV of net cash outflow**

Cost of new machine	4,20,000
Less: Exchange price for old machine	1,05,000
	3,15,000
Add: Tax on profit on exchange [1,05,000 – 70,000] [35,000 x 50%]	17,500
Net Investment	3,32,500

**Step 2: Calculation of PV of incremental operating cash inflows for 10 years**

	Existing	New	Incremental
Number of units	10,000	10,000	--
Variable cost per unit	52.5	42	1,05,000
Variable Cost	5,25,000	4,20,000	75,000
Repairs	75,000	--	[33,000]
Depreciation [2,10,000 – 70,000]/20 [4,20,000 – 20,000]/10	7,000	40,000	
Total Savings before tax			1,47,000
Less: Tax at 50%			73,500
Savings after tax			73,500
Add: Depreciation			33,000
CIAT			1,06,500



**Note:** The allocations from other department are irrelevant for decision making.

**Step 3: Calculation of terminal cash inflows**

Salvage value of machine = ₹ 20,000

**Step 4: Calculation of NPV**

Operating cash inflow from 1 to 9 years	₹
[1,06,500 x 5.759]	= 6,13,334
PV of cash inflow for 10th year (1,06,500 + 20,000) x 0.386	= 48,829
PV of total cash inflow	= 6,62,163
Less: Outflow	= 3,32,500
<b>NPV</b>	<b>= 3,29,663</b>

**Comment:**

Since NPV is positive, it is advised to replace the machine.

**Note:**

Since the exchange value is greater than open market value, the open market value is irrelevant.

**Illustration: 15**

Ram Ltd. specialise in the manufacture of novel transistors. They have recently developed technology to design a new radio transistor capable of being used as an emergency lamp also. They are quite confident of selling all the 8,000 units that they would be making in a year. The capital equipment that would be required will cost ₹25 lakhs. It will have an economic life of 4 years and no significant terminal salvage value.

During each of the first four years promotional expenses are planned as under:

1st Year	1	2	3	4
Advertisement	1,00,000	75,000	60,000	30,000
Others	50,000	75,000	90,000	1,20,000
Variable cost of production and selling expenses: ₹250 per unit				

Additional fixed operating costs incurred because of this new product are budgeted at ₹75,000 per year.

The company's profit goals call for a discounted rate of return of 15% after taxes on investments on new products. The income tax rate on an average works out to 40%. You can assume that the straight line method of depreciation will be used for tax and reporting.

Work out an initial selling price per unit of the product that may be fixed for obtaining the desired rate of return on investment.

Present value of annuity of ₹1 received or paid in a steady stream throughout 4 years in the future at 15% is 3.0079.

**Solution:****Calculation of Selling Price**

Let x be the selling price.

**Evaluation under NPV method****Step 1:**

Initial Investment = 25,00,000

**Step 2:**

PV of operating cash inflows per annum

A. Sales p.a.	8,000 X
B. Expenses:	
Depreciation $[(25,00,000 - 0)/4]$	6,25,000
Promotion Expenses	1,50,000
Variable costs (8,000 @ ₹ 250 per unit)	20,00,000
Fixed costs	75,000
Total	₹ 28,50,000
PBT (A-B)	= 8,000 X - 28,50,000
Less: Tax at 40%	= 3,200 X - 11,40,000
PAT	= 4,800 X - 17,10,000
Add: Depreciation	6,25,000
Cash inflow after tax	= 4,800 X - 10,85,000

**At required return at 15%**

PV of total cash inflow = outflow

$$[4,800 X - 10,85,000] \times 3.0079 = 25,00,000$$

$$14,437.92 X - 32,63,572 = 25,00,000$$

$$14,437.92 X = 32,63,572 + 25,00,000$$

$$X = \frac{32,63,572 + 25,00,000}{14,437.92}$$

$$= 399.196$$

$$= 400$$

Initial selling Price = ₹ 400

**Illustration: 16**

Rajesh Ltd is considering the purchase of a delivery van, and is evaluating the following two choices: The company can buy a used van for ₹ 20,000 and after 4 years sell the same for ₹ 2,500 (net of taxes) and replace it with another used van which is expected to cost ₹ 30,000 and has 6 years life with no terminating value,

The company can buy a new van for ₹ 40,000. The projected life of the van is 10 years and has an expected salvage value (net of taxes) of ₹ 5,000 at the end of 10 years.

The services provided by the vans under both the choices are the same. Assuming the cost of capital at 10 percent, which choice is preferable?

**Solution:****Calculation of mutually exclusive decision****Alternative I : Company purchased a used van****Calculation of PV of cash outflow:**

Year	Cash outflow	PV factor at 10%	Present Value
$t_0$	20,000	1	20,000
$t_4$	27,500 (30,000-2,500)	0.6830	18,783
PV of total cash outflow under Alternative I			38,783

**Alternative II : Company purchased a new van**

Year	Cash outflow	PV factor at 10%	Present Value
$t_0$	40,000	1	40,000
$t_{10}$	(5,000)	0.3855	(1,928)
PV of net cash outflow			38,072

**Comment:**

It is advised to select alternative II as it involves lower cash outflows.

**Illustration: 17**

Following are the data on a capital project being evaluated by the management of PKJ Ltd.:

	Project M
Annual cost saving	₹ 40,000
Useful life	4 years
I.R.R	15%
Profitability Index (PI)	1.064
NPV	?
Cost of capital	?
Cost of project	?
Pay back	?
Salvage value	0

Find the missing values considering the following table of discount factor only:

Discount Factor	15%	14%	13%	12%
1 year	0.869	0.877	0.885	0.893
2 years	0.756	0.769	0.783	0.797
3 years	0.658	0.675	0.693	0.712
4 years	0.572	0.592	0.613	0.636
	2.855	2.913	2.974	3.038

**Solution:**

CIAT = 40,000

Life = 4 years

IRR = 15%

PI = 1.064

At 15% IRR

PV of cash inflow = Cost of project

40,000 PVAF 4 yrs 15% = Cost of project

Cost of project = 40,000 x 2.855  
= 1,14,200

$$PI = \frac{\text{PV of cash inflow}}{\text{Initial outflow}}$$

= 1.064

$$1.064 = \frac{\text{PV of cash inflow}}{1,14,200}$$

PV of cash inflow = 1,21,509

Less: Outflow = 1,14,200

NPV = 7,309

At cost of capital

Let r be the Cost of Capital ( $K_0$ )

PV of cash inflow

40,000 PVAF r% 4 yrs = 1,21,509

PVAF n% 4 yrs = 1,21,509 / 40,000 = 3.038

r = 12%

$$\text{Payback period} = \frac{\text{Initial Investment}}{\text{Annual Cash flow}} = \frac{1,14,200}{40,000} = 2.855 = 3 \text{ years (approx)}$$

**Illustration: 18**

Projects P and Q are analysed and you have determined the following parameters. Advise the investor on the choice of a project:

Particulars	Project P	Project Q
Investment	₹ 7 Cr.	₹ 5 Cr.
Project life	8 years	10 years
Construction period	3 years	3 years
Cost of capital	15%	18%
N.P.V. @ 12%	₹ 3,700	₹ 4,565
N.P.V. @ 18%	₹ 325	₹ 325
I.R.R.	45%	32%
Rate of return	18%	25%
Payback	4 years	6 years
B.E.P.	45%	30%
Profitability index	1.76	1.35

**Solution:****Determination of Priority of the Project**

	P	Q
NPV at 12%	II	I
NPV at 18%	Same	Same
IRR	I	II
ARR	II	I
Pay back	I	II
PI	I	II

**Decision:**

1. As the outlays in the projects are different, NPV is not suitable for evaluation.
2. As there is different life periods, ARR is not appropriate method for evaluation.

On the basis of remaining evaluation methods [IRR, PBP, PI] Project P is occupied first priority. Hence, it is advised to choose project P.



## GLOSSARY

**Accounting or Average Rate of Return (ARR) or Return On Investment (ROI) Method:** This method uses accounting information as revealed by the financial statements, to measure the profitability of an investment project. The ARR is found out by dividing the average post-tax profit by the average investment.

**Capital Expenditure:** Capital Expenditure is the expenditure on fixed assets or additions thereto intended to benefit future accounting periods or expenditure which increases the capacity, efficiency, life span, or economy of operation of an existing fixed asset.

**Capital Expenditure Budget:** Capital Expenditure Budget is a plan for capital expenditure in monetary terms.

**Capital Expenditure Budgeting:** Capital Expenditure Budgeting is the process of analysing, appraising, and deciding about capital projects.

**Discounted Cash Flow:** Discounted Cash Flow (DCF) is one of the methods of investment project evaluation and selection that adjusts cash flows over time for the time value of money.

**Discounted Payback (DPB):** Discounted Payback (DPB) is defined as the number of years required in recovering the cash outlay of the project on the present value basis.

**Internal Rate of Return (IRR):** Internal Rate of Return (IRR) Method is a discounted cash flow technique which takes account of the magnitude and timing of cash flows. The IRR is that discount rate which equates investment outlay with the present value of inflows received after a period of time.

**Net Present Value (NPV):** Net Present Value (NPV) Method is a process of calculating the present value of a project's cash flows, using the opportunity cost of capital as the discount rate, and finding out the net present value by subtracting the initial investment from the present value of cash flows.

**Present Value:** Present Value is the current value of a future amount of money or a series of cash flows, calculated at a given interest rate.

**Profitability Index (PI) or Benefit-Cost (B/C) Ratio:** Profitability Index (PI) or Benefit-Cost (B/C) Ratio is the ratio of the present value of cash inflows, at the required rate of return, to the initial cash outflow of the investment.

**Terminal Value (TV):** Terminal Value (TV) is the value of an asset at some point of time in future.

### Self Learning Questions:

1. State the needs of Capital Budgeting Decisions.
2. What will be the effect on NPV of a one year project if fixed costs are increased from ₹ 200 to ₹300. When the firm is profit making, pays tax @35% and has 12% cost of Capital. [Ans: ₹58.04 decrease in NPV]
3. State the procedure involved in the "Forfeiting" Financial Services.
4. Write a short note on a Foreign Currency Convertible Bonds (FCCBs).
5. Explain the major steps in the capital budget process.
6. A bond costing @ ₹ 800 are redeemable after 5 years @ ₹ 1000. No interest is to be received and the discounting rate is 10%. What would be the NPV of bonds? [Ans: (179)]
7. State the significance of Capital Budgeting Decisions.
8. Explain the characteristic of a sound Appraisal method.
9. Distinguish between NPV and IRR.





10. What are the various financial factors used in Project Evaluation?
11. State the disadvantages of Pay Back period method.
12. Explain in brief the acceptance rule of Net Present Value method.
13. State the benefits accrue out of Internal Rate of return method.

### PRACTICAL PROBLEM:

#### Illustration: 1

Pankaj Ltd is evaluating a project costing ₹20 lakhs. The Project generates savings of ₹ 2.95 lakhs per annum to perpetuity. The business risk of the project warrants a rate of return of 15%.

- Calculate Base case NPV of the project assuming no tax.
- Assuming Tax Rate of 30% with 12% Cost of Debt constituting 30% of the cost of the project, determine Adjusted Present Value.
- Find out minimum acceptable Base Case NPV, as well as Minimum IRR.

#### Solution:

Computation of Base case NPV

Particulars	₹ lakhs
Investment Cost	20.00
Annual saving	2.95
Present value of Perpetual savings = $\frac{\text{Annual Savings}}{\text{Rate of Return}} = \frac{2.95}{15\%}$	19.67
Net Present Value [PV of Inflows 19.67 <b>Less</b> Investment Cost 20.00]	(0.33)

#### Observation:

The base case NPV is negative and therefore, the project cannot be accepted as it is.

Computation of Adjusted NPV

Particulars	₹ lakhs
Total Investment	20.00
Debt Component [30% of investment Cost of ₹20.00 Lakhs]	6.00
Interest on Debt @ 12% [₹6 Lakhs x 12%]	0.72
Tax saving on Interest on debt [₹0.72 Lakhs x 30%]	0.216
Present value of tax saving on perpetuity = $\frac{\text{Annual Savings}}{\text{Interest Rate}} = \frac{0.216}{12\%}$	1.80
Base case NPV	(0.33)
Adjusted NPV [base Case NPV + PV of tax saving due to Interest on debt]	1.47

Minimum base case NPV without Tax Shield



At Minimum Base case NPV, Adjusted NPV = 0

$$\Rightarrow 0 = \text{Base Case NPV} + \text{tax shield on Interest}$$

$$\Rightarrow 0 = \text{Base Case NPV} + ₹1.80 \text{ Lakhs}$$

$$\Rightarrow \text{Minimum base Case NPV} = (₹1.80 \text{ lakhs})$$

$$\Rightarrow 0 = \text{PV of perpetual Inflow} - \text{Investment} + \text{Tax shield}$$

$$\Rightarrow 0 = \frac{\text{Perpetual Inflow}}{0.15} - 20.00 + 1.80$$

$$\Rightarrow 0 = \frac{\text{Perpetual Inflow}}{0.15} - 18.20$$

$$\Rightarrow 18.2 = \frac{\text{Perpetual Inflow}}{0.15}$$

$$\Rightarrow \text{Perpetual Inflow} = ₹ 18.20 \text{ Lakhs} \times 0.15 = ₹ 2.73 \text{ Lakhs} \Rightarrow \frac{₹2.73 \text{ Lakhs}}{₹20.00 \text{ Lakhs}} = 13.65\%$$

### Illustration: 2

PKJ Ltd. is considering two mutually- exclusive projects. Both require an initial cash outl ₹10,000 each for machinery and have a life of 5 Years. The Company's required rate of return is 10% and it pays tax at 50%. The projects will be depreciated on a straight-line basis. The net cash flows (before taxes) expected to be generated by the projects and the present value (PV) factor (at 10%) are as follows:

	Year				
	1	2	3	4	5
	(₹)	(₹)	(₹)	(₹)	(₹)
Project 1	4,000	4,000	4,000	4,000	4,000
Project 2	6,000	3,000	2,000	5,000	5,000
PV factor (at 10%)	0.909	0.826	0.751	0.683	0.621

You are required to calculate

- I. The Pay Back Period of each project;
- II. The NPV and the profitability index of each project.

### Solution:

#### CALCULATION OF NET INCOME AND NET CASH FLOW AFTER TAXES:

Project -1

Year	Cash Flow before tax (₹)	Depreciation (₹)	Income before tax (₹)	Tax (₹)	Net Income (₹)	Net cash Flow after tax (₹)
1	4,000	2,000	2,000	1,000	1,000	3,000
2	4,000	2,000	2,000	1,000	1,000	3,000
3	4,000	2,000	2,000	1,000	1,000	3,000
4	4,000	2,000	2,000	1,000	1,000	3,000
5	4,000	2,000	2,000	1,000	1,000	3,000



## Project - 2

Year	Cash Flow before tax (₹)	Depreciation (₹)	Income before tax (₹)	Tax (₹)	Net Income (₹)	Net cash Flow after tax (₹)
1	6,000	2,000	4,000	2,000	2,000	4,000
2	3,000	2,000	1,000	500	500	2,500
3	2,000	2,000	-	-	-	2,000
4	5,000	2,000	3,000	1,500	1,500	3,500
5	5,000	2,000	3,000	1,500	1,500	3,500

## I. Pay Back Period:

## PROJECT -1

Cash outlay ₹10,000

Cash flow p.a. ₹ 3,000

Payback period:  $10,000 / 3,000 = 3.33$  years

## PROJECT - 2

Cash inflows: ₹ (4,000 + 2,500 + 2,000) = ₹8,500 in 3 Years.

4th Year Balance - ₹1,500.

Therefore,  $1,500/3,500 = 0.43$  Years

Payback period = 3 Years + 0.43 Years = 3.43 years.

## II. Net Present value (NPV):

## PROJECT-1:

Present value =  $3,000 \times 3.790 = ₹ 11,370$

( $0.909 + 0.826 + 0.751 + 0.683 + 0.621$ )

Less: Initial cash outlay = ₹ 10,000

Net Present value (NVP) = ₹ 1,370

PROFITABILITY INDEX =  $11,370/10000 = 1.1370$

## PROJECT - 2:

Net cash flow after tax (₹)	PV factor	Present Value (₹)
4,000	0.909	3636.00
2,500	0.826	2065.00
2,000	0.751	1502.00
3,500	0.683	2390.50
3,500	0.621	2173.50
		11,767
Less: Initial cash outlay		10,000.00
Net Present value (NPV)		1,767

PROFITABILITY INDEX =  $11,767/10,000 = 1.177$

**Illustration: 3**

A chemical company is considering replacing an existing machine with one costing 765,000. The existing machine was originally purchased two years ago for 728,000 and is being depreciated by the straight line method over its seven-year life period. It can currently be sold for 730,000 with no removal costs. The new machine would cost 710,000 to install and would be depreciate over five years. The management believes that the new machine would have a salvage value of 75,000 at the end of year 5. The management also estimates an increase in net working capital requirement of 710,000 as a result of expanded operations with the new machine. The firm is taxed at a rate of 55% on normal income and 30% on capital gains. The company's expected after-tax profits for next 5 years with existing machine and with new machine are given as follows:

Year	Expected after-tax profits	
	With existing machine	With new machine
1	2,00,000	2,16,000
2	1,50,000	1,50,000
3	1,80,000	2,00,000
4	2,10,000	2,40,000
5	2,20,000	2,30,000

- (a) Calculate the net investment required by the new machine.  
 (b) If the company's cost of capital is 12%, determine whether the new machine should be purchased.

**Solution:**

(a) Net Investment required by the New Machine:

Calculation of present value of net investment required:

	(₹)
Cost of new asset	65,000
Add: Installation cost	10,000
	75,000
Add: Additional WC	10,000
	85,000
Less: Sale proceeds of old machine	30,000
Less: Tax $[8,000 \times 55/100 + 2000 \times 30/100]$	5,000
Net Investment required	50,000

(b) Appraisal of Replacement decision under NPV Method:

Calculation of Present Value of Incremental Operating cash inflows for 5 years.

Year	CIAT (PAT + Dep)		Incremental	PV factor at 12%	Present Value
	Old	New			
1	2,04,000	2,30,000	26,000	0.8928	23,213
2	1,54,000	1,64,000	10,000	0.7971	7,971
3	1,84,000	2,14,000	30,000	0.7117	21,351
4	2,14,000	2,54,000	40,000	0.6355	25,420
5	2,24,000	2,44,000	20,000	0.5674	11,348
PV of cash inflows for 5 years					89,303



Calculation of PV of terminal cash inflow	₹
Salvage value of asset	5,000
[No taxes because book value and salvage value are equal]	
Working capital recovered [100% recovered]	<u>10,000</u>
Terminal cash inflows	15,000
Its PV at the end of 5th year = $15,000 \times 0.5674 = 8,511$	
Calculation of NPV	₹
PV of total cash inflows [89,303 + 8,511]	= 97,814
(-) Outflow (Net Investment Required)	= 60,000
NPV	= 37,814

**Comment:**

As NPV is positive, it is advised to replace.

**Note 1:**

Depreciation for old Machine =  $28,000 / 7 = ₹ 4,000$

Depreciation for new Machine =  $[(₹65,000 + ₹10,000 - ₹5,000) \div 5] = ₹ 14,000$ .

**Illustration: 4**

A limited company is considering investing a project requiring a capital outlay of ` 2,00,000. Forecast for annual income after depreciation but before tax is as follows:

Year	(₹)
1	1,00,000
2	1,00,000
3	80,000
4	80,000
5	40,000

Depreciation may be taken as 20% on original cost and taxation at 50% of net income. You are required to evaluate the project according to each of the following methods:

- Pay-back method
- Rate of return on original investment method
- Rate of return on average investment method
- Discounted cash flow method taking cost of capital as 10%
- Net present value index method
- Internal rate of return method.
- Modified internal rate of return method.



**Solution:**

**Working Notes:**

Year	Profit before tax	Profit after tax @ 50%	Cash inflows after tax [pat + Dep]	Cumulative cash inflow	Dis-counting factor @ 10%	Present value	Dis-counting factor @ 20%	Present value @ 20%	Dis-counting factor @ 30%	Present value @ 30%	Dis-counting factor @ 32%	Present value @ 32%
1	1,00,000	50,000	90,000	90,000	0.9091	81,819	0.8333	74,997	0.7692	69,228	0.7576	68,184
2	1,00,000	50,000	90,000	1,80,000	0.8264	74,376	0.6944	62,496	0.5917	53,253	0.5739	51,651
3	80,000	40,000	80,000	2,60,000	0.7513	60,104	0.5787	46,296	0.4552	36,416	0.4348	34,784
4	80,000	40,000	80,000	3,40,000	0.6830	54,640	0.4823	38,584	0.3501	28,008	0.3294	26,352
5	40,000	20,000	60,000	4,00,000	0.6209	37,254	0.4019	24,114	0.2693	16,158	0.2495	14,970
						3,08,193		2,46,487		2,03,063		1,95,941

(a) **Pay Back Method:** Payback period = 2,00,000/80,000 = 2.5 years (or) 2 years 3 months

(b) **Rate of Return on Original Investment Method:** ARR = Average Profit after Tax / Investment × 100 = 40,000 / 2,00,000 × 100 = 20%

(c) **Rate of Return on Average Investment Method:** ARR = Average Profit after tax / Average investment × 100  
 = 40,000 / [2,00,000 + 0/2] × 100  
 = 40%

(d) **Discounted Cash Flow Method taking Cost of Capital as 10%**

	(₹)
Present value of cash inflows after tax	3,08,193
Less: Outflow	2,00,000
Net Present Value	1,08,193

(e) **Profitability Index**

Profitability Index = P.V of Cash Inflows / Cash Outflow = 3,08,193 / 2,00,000 = 1.54

Since PI is more than 1 it can accept the project.

(f) **Internal Rate of Return Method**

$$\begin{aligned} \text{IRR} &= L + [P1 - I / P1 - P2] \times d \\ &= 30 + [2,03,063 - 2,00,000 / 2,03,063 - 1,95,941] \times 2 \\ &= 30 + 0.8602 = 30.8602\% \end{aligned}$$

(g) **MIRR**

	1	2	3	4	5	Total (₹)
Cash inflow after tax	90,000	90,000	80,000	80,000	60,000	--
Re-investment period	4	3	2	1	0	
Re-investment at	10%	10%	10%	10%	10%	
Future value factor	(1.1) <sup>4</sup>	(1.1) <sup>3</sup>	(1.1) <sup>2</sup>	(1.1)	1	
Future value	1,31,769	1,19,790	96,800	88,000	60,000	4,96,359

At MIRR = 2,00,000 [1 + MIRR]<sup>5</sup> = 4,96,359

$$= [1 + \text{MIRR}]^5 = 4,96,359 / 2,00,000 = 2.48$$

MIRR = 20% (Refer Annuity tables)



PREVIOUS TERMS QUESTION PAPERS

INTERMEDIATE EXAMINATION

June 2019

P-10 (CMFM)  
Syllabus 2016

**Cost & Management Accounting and Financial Management**

Time Allowed: 3 Hours

Full Marks: 100

*The figures in the margin on the right side indicate full marks.*

*All workings must form part of your answer.*

*Wherever necessary, Candidates may make appropriate assumptions and clearly state them.*

*Please (1) Write answers to all parts of a question together.*

*(2) Open a new page for answers to a new question.*

*(3) Attempt the required number of questions only.*

**This Paper has been divided into two Parts A & B, each carrying 50 marks.**

**Further each Part has been divided into two sections each.**

**Part - A**

**(COST & MANAGEMENT ACCOUNTING)**

**(50 Marks)**

**Section - I**

**Answer the following questions.**

1. (a) **Choose the correct answer from the given four alternatives** (You may write only the Roman numeral and Alphabet chosen for your answer): 1x6=6
- (i) Management Accounting
- (A) accumulates, summarises and analyses the available data.
- (B) is primarily concerned with the requirements of the management.
- (C) makes Corporate Planning and Strategy Effective.
- (D) All of the above
- (ii) XYZ Ltd., makes a special gadget for the car it manufactures. The machine for the gadget works to full capacity and incurs ₹ 15 Lakhs and ₹ 40 Lakhs respectively as Variable and Fixed Costs. If all the gadgets were purchased from an outside supplier, the machine could be used to produce other items, which would earn a total contribution of ₹ 25 Lakhs. What is the maximum price that XYZ Ltd., should be willing to pay to the outside supplier for the gadgets, assuming there is no change in Fixed Costs?
- (A) ₹ 40 Lakhs
- (B) ₹ 65 Lakhs
- (C) ₹ 25 Lakhs
- (D) ₹ 15 Lakhs



(iii) When a manager is concerned with monitoring total cost, total revenue and net profit conditioned upon the level of productivity, an accountant should normally recommend

	Flexible	Standard
	Budgeting	costing
(A)	Yes	Yes
(B)	Yes	No
(C)	No	Yes
(D)	No	No

(iv) In a system whereby all activities are re-evaluated each time a budget is formulated and starts with assumption that requirements of funds does not exist is called

- (A) Performance Budgeting
- (B) Programme Budget
- (C) Flexible Budget
- (D) Zero-based Budgeting

(v) The difference between hours paid and hours worked is known as

- (A) Labour rate variance
- (B) Labour efficiency variance
- (C) Idle time variance
- (D) Net efficiency variance

(vi) The difference in total cost that results from two alternative courses of action is called

- (A) Relevant Cost
- (B) Opportunity Cost
- (C) Differential Cost
- (D) Marginal Cost

(b) **Match the statement under Column I with the most appropriate statement under Column II:** (You may opt to write only the numeral and the matched alphabet instead of copying the contents into the answer book): 1x4=4

Column I		Column II	
1	Budgetary Control System	(A)	are useful for budget and performance evaluation
2	Standard Costs	(B)	helps in profit planning and analysis
3	Marginal Costing	(C)	aims at adherence to planning costs
4	Cost Control	(D)	The introduction and implementation of the system may be expensive

(c) **State whether the following statements are True or False:** (You may write only the Roman numeral and whether True or False without copying the statement into the answer book.): 1x4=4

- (i) Marginal Costing is useful for long term planning.
- (ii) Profit Planning and Control is not a part of Budgetary Control Mechanism.
- (iii) Standard Costs are based on technical assessments.
- (iv) PV Chart exhibits the relationship between profit and overhead volume.





### Section – II

Answer any three questions from question nos. 2, 3, 4 and 5.

Each question carries 12 marks.

2. (a) AARINA LTD., sells its product at ₹ 30 per unit. During the quarter ending 31st March, 2019 it produced and sold 16000 units and suffered a loss of ₹ 10 per unit. If the volume of sales is raised to 40000 units, it can earn a profit of ₹ 8 per unit.

You are required to **calculate**:

- (i) Break-Even Point in Rupees.  
(ii) Profit, if the sales volume is 50000 units.

2+2=4

- (b) TRITONI LTD., produces 3 products A, B and C from the same manufacturing facilities. The cost and other details of the 3 products are as follows:

Particulars	A	B	C	Total
Selling Price/unit (₹)	200	160	100	
Variable Cost/unit (₹)	120	120	40	
Fixed Expenses/month (₹)				2,76,000
Maximum Production/month (units)	5000	8000	6000	
Total Hours available for the month				200
Maximum demand/month (units)	2000	4000	2400	

The processing hours cannot be increased beyond 200 hours/month.

You are **required to**:

- (i) Compute the most profitable mix.  
(ii) Compute the overall break-even sales of the company for the month based on the mix calculated in (i) above.

4+4=8

3. (a) WESTLAND LTD., a manufacturing company operates standard costing system and showed the following data in respect of the month of May 2019:

Budgeted		Actual	
Working days	20	Working days	22
Man hours	4000	Man hours	4200
Fixed overhead cost (₹)	2400	Fixed overhead cost (₹)	2500
Output (units)	800	Output (units)	900

You are required to **calculate** the following Fixed overheads variances:

- (i) FOH Budget Variance  
(ii) FOH Cost Variance  
(iii) FOH Efficiency Variance  
(iv) FOH Capacity Variance  
(v) FOH Calendar Variance  
(vi) FOH Volume Variance

6



(b) SHIBHUMA LTD., budgets to sell in the quarter ending March 31, 2019:

- 500 Units of product P @ ₹ 30 per unit,
- 400 Units of product Q @ ₹ 20 per unit and
- 100 Units of product R @ ₹ 50 per unit.

During the quarter **Actual Sales** were as follows:

- 400 Units of product P @ ₹ 40 per unit.
- 500 Units of product Q @ ₹ 10 per unit.
- 50 Units of product R @ ₹ 40 per unit.

You are required to **determine** the following sales variances:

- (i) Sales Value variance
- (ii) Sales Price Variance
- (iii) Sales Volume Variance
- (iv) Sales Mix Variance
- (v) Sales Sub-Volume Variance

6

4. (a) SBT LTD., a newly established manufacturing company has an installed capacity to produce 100000 units of a consumer product annually. However its practical capacity is only 90%.

The actual capacity utilization may be substantially lower, as the firm is new to the market and the demand is uncertain.

The following budget has been prepared for 90% capacity utilization.

Particulars	Cost per unit (₹)
Direct Materials	12
Direct Labour	8
Direct Expenses	5
Production Overheads	10 (40% Variable)
Administrative Overheads	5 (100% Fixed)
Selling and Distribution	6 (50% Variable)

You are required to **prepare** the budgets at 70% and 80% levels of capacity utilization giving clearly the

- (i) Unit Variable Costs
- (ii) Unit Fixed Cost
- (iii) Total Cost under various heads at all the above levels

6

(b) DANDIA LTD., a manufacturing company received an order for 16 units of a new product. So far, 4 units have been completed; the first unit required 40 direct labour hours and a total of 102.40 Direct labour hours has been recorded for the 4 units. The Production Manager expects on 80% learning effect for this type of work.

The direct cost attributed to the centre in which the unit is manufactured and its costs are as follows:

	₹
Direct Material	30.00 per unit
Direct Labour	6.00 per hour
Variable overhead	0.50 per direct labour hour
Fixed overheads apportioned	5.00 per direct labour hour

You are **required to produce** an estimated product cost for the initial order based on the cost data given.

6



5. Write short notes on *any three* out of the following:
- (a) Distinction between Standard Costing and Budgetary Control
  - (b) Inter Firm Comparison
  - (c) Methods of Transfer Pricing
  - (d) Limitations of Marginal Costing

**Part-B**

**(FINANCIAL MANAGEMENT)**

**(50 Marks)**

**Section – III**

Answer the following questions:

6. (a) **Choose the correct answer from the given four alternatives** (You may write only the Roman numeral and Alphabet chosen for your answer): 1x6=6
- (i) Objective of Financial Management is
    - (A) Management of Liquidity
    - (B) Maximization of Profit
    - (C) Maximization of Shareholders' Wealth
    - (D) Management of Fixed Assets
  - (ii) Which of the following variables is not known in Internal Rate of Return?
    - (A) Initial Cash Flows
    - (B) Discount Rate
    - (C) Terminal Inflows
    - (D) Life of the Project
  - (iii) Cost of Capital refers to
    - (A) Floatation Cost
    - (B) Dividend
    - (C) Required Rate of Return
    - (D) None of the above
  - (iv) Working Capital Management involves financing and management of
    - (A) All Assets
    - (B) All Current Assets
    - (C) Cash and Bank Balance
    - (D) Receivables and Payables
  - (v) All listed companies are required to prepare
    - (A) Funds Flow statement
    - (B) Cash Flow Statement
    - (C) Statement of Affairs
    - (D) All of the above



(vi) Ratio Analysis can be used to study liquidity, turnover, profitability etc., of a firm. What does Debt-Equity Ratio help to study?

- (A) Solvency
- (B) Liquidity
- (C) Profitability
- (D) Turnover

(b) **Match the statement under Column I with the most appropriate statement under Column II:** (You may opt to write only the numeral and the matched alphabet instead of copying the contents into the answer book): 1x4=4

Column I		Column II	
1.	Important element of Capital Budgeting is	(A)	represents a risky situation
2.	High Operating and Financial Leverage	(B)	may affect the size of working capital
3.	A consistent dividend policy	(C)	a tool for analysis of financial statements
4.	Fund Flow Statement is	(D)	the analysis of risk and uncertainty

(c) **State whether the following statements are True or False:** (You may write only the Roman numeral and whether True or False without copying the statement into the answer book.) 1x4=4

- (i) In Financial Management, the objective of Financial Manager is profit maximization.
- (ii) Investment Decisions and Capital Budgeting are one and the same.
- (iii) Operating Leverage analyses the relationship between Sales Level and Earning Per Share (EPS).
- (iv) The Cost of Capital is the required rate of return to maintain the value of the firm.

#### Section – IV

Answer any three questions from question nos. 7, 8, 9 and 10.

Each question carries 12 marks.

7. (a) The Balance Sheet of VASUDHA LTD. as on March 31, 2019 is as given below:

(Amount in ₹ lakhs)

Equity and Liabilities	Amount	Assets	Amount
Equity Share Capital	250	Fixed Assets	400
General Reserve	280	Investment	50
Profit & Loss a/c (Current year)	30	Stock	460
Secured Loans—Long Term	300	Debtors	460
Secured Loans—Short Term	360	Cash and cash equivalents	10
Creditors	150	Miscellaneous Expenditure (not Written off)	20
Other Liabilities	30		
	1,400		1,400

*Additional informations:*

- (i) From the P&L A/c, ₹ 90 Lakhs was transferred to General Reserve during the year



- (ii) Interest Cost amounted to ₹ 120 lakhs  
 (iii) Taxation @ 40%

You are required to **calculate**

- (i) Current Ratio  
 (ii) Debt-Equity Ratio

6

(b) The following are the financial statement of KODIAC LTD. for the year ended March 31.

Balance Sheet as on March 31, (Amount in ₹ Thousand)

	2019	2018		2019	2018
Equity & Liabilities			Assets		
Share Capital	5,000	5,000	Fixed Assets	10,500	8,500
Profit & Loss A/c	5,000	4,250	Stock	3,000	3,400
Long-term Loan	5,500	5,000	Debtors	3,450	3,800
Creditors	1,800	1,750	Cash and cash equivalents	350	300
	17,300	16,000		17,300	16,000

Income Statement for the year ended 31.3.2019.

(Amount in ₹ Thousand)

Sales	21,500
Less: Cost of Sales	(14,700)
	6,800
Less: Operating Expenses:	
Administrative Expenses	(2,400)
Depreciation	(1,000)
	3,400
Add: Dividend Received	250
	3,650
Less: Interest Paid	(700)
	2,950
Less: Income Tax	(1,300)
Profit after Tax	1,650

KODIAC Ltd. paid dividend of ₹ 9,00,000 during the year ended 31.03.2019.

Required:

Prepare a Cash Flow Statement of Kodiak Ltd. As per AS-3 (Revised) for the year ended March 31, 2019 using Indirect Method.

6

8. (a) GOLDILOCKS LTD. sells goods to domestic market on a gross profit of 25% on sales without considering depreciation. Its estimates for the year 2019-20 are as follows:



(Amount in ₹ Lakh)

<b>Sales:</b>	
Domestic Market at 2 months' Credit	1600
Export (Selling price 10% below home price) (Exports at 3 months' Credit)	540
<b>Cost:</b>	
Materials used (Suppliers extend 2 months' Credit)	600
Wages paid (1/2 month in Arrear)	400
Manufacturing Expenses (Paid 1 month in Arrear)	600
Sales Promotion (Payable quarterly in advance)	80
Administration Expenses (Paid 1 month in Arrear)	200

The company maintains one month's stock of each raw material and finished goods.

A cash balance of ₹ 20 lakh is also maintained.

There is no Work-in-Progress (WIP).

All expenses and incomes are made evenly throughout the year.

Required:

Prepare a statement of Working Capital Requirements of the Company for 2019-20 on Cash Cost basis. 7

(b) HILSON LTD. was started a year back with equity capital of ₹ 40 lakhs. The other details are as under:

Earnings of the company	₹ 4,00,000
Price Earning ratio	12.5
Dividend paid	₹ 3,20,000
Number of Shares	40,000

Required:

- Find the Current Market price of the share, and
- Find whether the Company's D/P ratio is optimal—using Walter's model.

5

9. (a) The WONDERLAND LTD. has the following Book Value Capital Structure as on March 31, 2019:

	(Amount in ₹ Thousand)
600000 Equity Share at ₹ 10 each fully paid	6000
10000, 9% Preference Shares of ₹ 100 each	1000
30000, 12% Debentures of ₹ 100 each	3000
	10000

The equity share of the Company sells at ₹ 20 per share. The dividend expected next year is ₹ 2.5 per share, which is expected to grow at 5% per annum. Corporate tax rate is 30%.

You are required to **determine** the Weighted Average Cost of Capital (WACC) of Wonderland Ltd. based on the existing Capital Structure.

6



- (b) ELROND LTD. (EL) has just installed MACHINE A at a cost of ₹ 2,00,000. This machine has 5 years life with no residual value. The annual volume of production is estimated at 150000 units, which can be sold at ₹ 8 per unit. Annual operating costs are estimated at ₹ 2,00,000 (excluding depreciation) at this output level. Fixed costs are estimated at ₹ 4,50,000 per annum for the same level of production.

The company has just come across another model called MACHINE B capable of giving the same output at an annual operating costs of ₹ 1,50,000 (excluding depreciation). There will be no change in fixed costs. Capital cost of this machine is ₹ 2,50,000 and the estimated life is 5 years with no residual value.

The company has an offer for sale of MACHINE A at ₹ 1,00,000. But the cost of dismantling and removal will amount to ₹ 30,000. As the company has not yet commenced operation, it wants to sell MACHINE A and purchase MACHINE B.

ELROND LTD. will be zero-tax company for 7 years in view of several incentives and allowances available. The cost of capital is 14%.

Required:

**Based on the NPV Criterion**, advise the Company whether it should opt to replace MACHINE A by installing MACHINE B.

[Given : PVIFA (14%, 5 years) = 3.433 and PVIF (14%, 5 years) = 0.519] (Solve the problem by an incremental cash flow approach.)

6

10. Write short notes on any *three* out of the following:

4x3=12

- (a) Lease Financing
- (b) Objectives, Functions and Powers of the Securities Exchange Board of India (SEBI)
- (c) Window Dressing
- (d) Significance of Funds Flow Statement (FFS)



## INTERMEDIATE EXAMINATION

December 2018

P-10 (CMFM)

Syllabus 2016

### Cost & Management Accounting and Financial Management

Time Allowed: 3 Hours

Full Marks: 100

*The figures in the margin on the right side indicate full marks.*

*All workings must form part of your answer.*

*Wherever, necessary, Candidates may make appropriate assumptions and clearly state them.*

*Please (i) Write answers to all parts of a question together.*

*(ii) Open a new page for answers to a new question.*

*(iii) Attempt the required number of questions only.*

This Paper has been divided into two Parts A & B, each carrying 50 marks.

Further each Part has been divided into two sections each.

#### Part - A

#### (COST & MANAGEMENT ACCOUNTING)

(50 Marks)

#### Section - I

Answer the following questions.

1. (a) **Choose the correct answer from the given four alternatives** (You may write only the Roman numeral and alphabet chosen for your answer): 1×6=6
- (i) The well - known basic function of management is
- (A) Motivating  
(B) Leadership  
(C) Decision-making  
(D) Communicating
- (ii) Contribution margin is equal to
- (A) Sales-Fixed Cost-Profit  
(B) Profit + Variable Cost  
(C) Fixed Cost-Loss  
(D) None of the above
- (iii) In a system whereby all activities are revaluated each time a budget is formulated and starts with the assumption that requirement of funds does not exist is called
- (A) Performance Budgeting  
(B) Programme Budgeting  
(C) Flexible Budgeting  
(D) Zero-based Budgeting





- (iv) The management's time is saved by reporting only the deviations from the predetermined standards is called
- (A) Management by objectives
  - (B) Budgetary Control
  - (C) Standard Costing
  - (D) Management by Exception
- (v) Marginal Costing is also known as
- (A) Direct Costing
  - (B) Absorption Costing
  - (C) Variable Cost
  - (D) Variable Costing
- (vi) Another name for 'Contribution' is
- (A) Marginal Income
  - (B) Gross Profit
  - (C) Net Income
  - (D) None of the above

- (b) **Match the statement under Column I with the most appropriate statement under Column II** (You may opt to write only the numeral and the matched alphabet instead of copying the contents into the answer book): 1×4= 4

Column I		Column II	
1	Learning Curve	(A)	Theodore P. Wright
2	Transfer Price	(B)	Cumulative Average Time
3	Experience Curve	(C)	Notional Value
4	Factors affecting the cost of Airlines	(D)	Boston Consulting Group

- (c) **State whether the following statements are True or False** (You may write only the Roman numeral and whether True or False without Copying the Statement into the answer book): 1×4= 4
- (i) Standard Costing may not be suitable for small concerns
  - (ii) Production Budget is prepared before Sales Budget
  - (iii) Budgets are always prepared for one year
  - (iv) At Break Even Point, the Margin of Safety is nil

### SECTION – II

Answer any *three* questions from Question No. 2,3,4 and 5,

Each question carries 12 marks.

2. (a) CADINI LTD., a factory engaged in manufacturing Plastic Buckets is working to 40% capacity and produces 10,000 Buckets per annum. The present cost break-up for one Bucket is:
- Material - ₹10
  - Labour- ₹3 and
  - Over head - ₹5 (out of which 60% is fixed)



The Selling Price is ₹20 per Bucket

If it is decided to work the factory at 50% capacity, the Selling Price falls by 3%.

**Calculate:**

- (i) The profit at 50% capacity.
- (ii) Break Even Quantity in units.

4+2=6

- (b) XER Co. manufactures an electronic product and puts a price tag of ₹190.00 as wholesale price. The company has a production and storage facility with a 100,000 unit monthly output capacity based on running an 8 hours shift each workday.

Estimated Costs are given below:

Monthly Fixed Costs	(₹)	Per Unit Costs	(₹)
Building Depreciation	2,50,000	Production Labour	45.00
Project Management	1,75,000	Supervisors Charges	5.00
Advertising Costs	3,00,000	Material Handling	8.00
Network Administration	75,000	Sales Commissions	12.00
Office Expenses	1,50,000	Materials	70.00
Equipment (Depreciation)	2,00,000	Electricity Costs	3.00

**Required:**

- (i) Based on the information provided, what quantity must this firm produce in order to be at breakeven?
- (ii) If the firm produces at the plant's capacity, what is the minimum price at which the firm can sell the product and still breakeven?
- (iii) Suppose the firm seeks to target profit of ₹30,00,00 from this product based on the input costs and wholesale price noted in the problem. How many units would the firm need to produce to generate the required profit?

6

- 3. (a) The following information is available from the records of REEDYAAH LTD., a manufacturing company using Standard Costing System for the week ended April 30, 2018:

	Standard		Actual	
	Qty.	Unit Price	Qty.	Unit Price
Material 'A'	60%	₹20	44 kg	₹25
Material 'B'	40%	₹10	66 kg	₹5
Processing Loss	10%	--	--	--
			Actual output 90 kg	

**Required:**

**Calculate** from the information stated Supra:

- (i) Material Cost Variance
- (ii) Material Price Variance
- (iii) Material Usage Variance
- (iv) Material Mix Variance
- (v) Material Yield Variance

6



- (b) The following information has been obtained from the records of PURNOMINA LTD., a manufacturing organization using the Standard Costing System for the month ended March 31, 2018:

	Budget	Actual
Production (Units)	4000	3800
Working days	20	21
Fixed overhead (₹)	40000	39000

**You are required** to calculate the following overhead cost variances:

- (i) Fixed overhead expenditure variance;
- (ii) Fixed overhead volume variance;
- (iii) Fixed overhead efficiency variance;
- (iv) Fixed overhead calendar variance;
- (v) Fixed overhead cost variance;

6

4. (a) You are given the following particulars concerning MINTEX LTD, a manufacturing organisation:

At 80% capacity (₹)

*Variable Overheads:*

Indirect Labour	12,000
Stores (including Spares)	4,000

*Semi-Variable Overheads:*

Power (30% Fixed)	20,000
Repairs & Maintenance (60% Fixed)	2,000

*Fixed Overheads:*

Depreciation	11,000
Insurance	3,000
Salaries	10,000
Total Overheads	62,000
Estimated Directed Labour Hours	124,000 Hours

**You are required to:**

- (i) Draw a Flexible Budget for Overhead expenses on the basis of the above data at 80% and 90% Plant Capacity.
- (ii) Determine the Overhead Rates at 80% and 90% Plant Capacity.

4+2=6

- (b) RADIANCE ENGINES LTD. manufacture engines mounting for Akash airlines. They have been asked to bid on a prospective contract for 30 engines mounting for the Jet aircraft. They have just completed and initial run of 10 of these mounting at the following costs:

Particulars	Amount in ₹
Direct Materials	7,000
Direct labour (2000 hours @ ₹4)	8,000
Variable overhead (₹0.50 per labour hour)	1,000
Fixed overhead (₹1 per labour hour)	2,000
	18,000



An 80% learning curve is thought to be pertinent in this case. Marketing Director believes that the quotation is unlikely to be accepted if it exceeds ₹38,000 and as the company are short of work, he believes the contract to be vital.

**You are required to comment** whether it is worth accepting at ₹38,000

6

5. Write short notes on *any three* out of the following:

4×3=12

- (i) Application of Marginal Costing in Decision Making
- (ii) Advantages of Standard Costing
- (iii) Distinctive Features of Learning Curve Theory
- (iv) Difference between Fixed and Flexible Budget (Any four points)

**Part – B**

**(FINANCIAL MANAGEMENT)**

**(50 Marks)**

**SECTION – III**

Answer the following Questions.

6. (a) **Choose the correct answer from the given four alternatives** (You may write only the Roman numeral and the alphabet chosen for your answer):

1×6= 6

- (i) Which of the following does not help to increase Current Ratio?
  - (A) Issue of Debentures to buy Stock
  - (B) Issue of Debentures to pay Creditors
  - (C) Sale of Investment to pay Creditors
  - (D) Avail Bank Overdraft to buy Machine
- (ii) Which of the following is not considered while preparing cash budget?
  - (A) Accrual Principal.
  - (B) Difference in Capital and Revenue items.
  - (C) Conservation Principle.
  - (D) All of the above.
- (iii) Cost of capital may be defined as:
  - (A) Weighted Average cost of all debts.
  - (B) Rate of Return expected by Equity Shareholders.
  - (C) Average IRR of the Projects of the firm.
  - (D) Minimum Rate of Return that the firm should earn.
- (iv) At Indifference level of EBIT, different capitals have:
  - (A) same EBIT.
  - (B) same EPS.
  - (C) same PAT.
  - (D) same PBT.



- (v) ABC Analysis is used in
  - (A) Inventory Management.
  - (B) Receivables Management.
  - (C) Accounting Policies.
  - (D) Corporate Governance.
- (vi) Which of the following is not incorporated in Capital Building?
  - (A) Tax-Effect.
  - (B) Time Value of Money.
  - (C) Required Rate of Return.
  - (D) Rate of Cash Discount.

- (b) **Match the statement under Column I with the most appropriate statement in Column II off to** (You may opt to write only the numeral and matched alphabet instead of copying contents into the answer book):

1×4=4

Column I		Column II	
(1)	Gordon's Model	(A)	Activity Ratio
(2)	Discounted Cash Flow	(B)	Inventory Management
(3)	Carrying Cost	(C)	Internal Rate of Return
(4)	Working Capital Turnover Ratio	(D)	Relevance of Dividends on share value

- (c) State whether the following statements are *True* or *False* (You may write only the Roman numeral and whether True or False without copying the statements into the answer book) 1×4=4
- (i) In mutually exclusive capital budgeting decisions, the firm can accept all feasible proposals.
  - (ii) Weighted Average Cost of Capital is always calculated with reference to book value of different sources of funds.
  - (iii) Debt-Equity Ratio is a measure of long-term solvency of a firm.
  - (iv) Capital Rationing as a situation when the Government has imposed a ceiling on investment by a firm.

#### SECTION – IV

Answer any three questions from Question No. 7, 8,9 and 10,

Each question carries 12 marks.

7. (a) **Complete the Balance Sheet** in the table below for TANISH LTD. using the following financial data:
- (i) Total Debt to Net Worth = 1:2
  - (ii) Total Assets Turnover = 2
  - (iii) Gross Profit on Sales = 30%
  - (iv) Average Collection Period (Assume 360 days in a year) = 40 days
  - (v) Inventory Turnover Ratio on Cost of Goods Sold and year-end inventory = 3
  - (vi) Acid Test Ratio = 0.75



Balance Sheet as on 31st March 2018			
Liabilities	₹	Assets	₹
Equity Share Capital	4,00,000	Planet & Machinery & Other Fixed Assets	-----
Reserves and Surplus	6,00,000		
Total Debt:		Current Assets:	
Current Liabilities	-----	Inventory	-----
		Debtors	-----
		Cash	-----
Total	-----	Total	-----

Assume that there is no Bank OD in this Balance Sheet format

6

(b) VEDIKA LTD. gives you the following information for the year ended 31st March, 2018:

- (i) Sales for the year totalled ₹96,00,000. The company sells goods for cash only.
- (ii) Cost of goods sold was 60% of sales. Closing inventory was higher than opening inventory by ₹20,000.
- (iii) Tax paid amounted to ₹7,00,000. Other expenses totalled ₹21,45,000. Outstanding expenses on 31st March, 2017 and 31st March, 2018, totalled ₹82,000 and ₹91,000 respectively.
- (iv) New machinery and furniture costing ₹10,50,000 in all were purchased. One equipment was sold for ₹20,000.
- (v) A right issue was made of 50,000 shares of ₹10 each at a premium of ₹3 per share. The entire money was received with application.
- (vi) Dividends totalling ₹4,00,000 were distributed among the shareholders.
- (vii) Cash in hand and at Bank as at 31st March, 2017 and 31st March, 2018 totalled ₹2,10,000 and ₹4,14,000 respectively.

**You are required to prepare cash flow statement** as per CAS-3 for the year ended 31st March, 2018 using the Direct method.

6

8. (a) GOLDEN GARMENT LTD. manufactures readymade garments and sells them on credit basis through a network of dealers. It present sale is ₹60 lakh per annum with 20 days credit period. The company is contemplating an increase in the credit period with a view to increasing sales. Present variable costs are 70 per cent of sales and the total fixed costs ₹8 lakh per annum.

The company expects pre-tax return on investment @25per cent. Some other details are given as under:

Proposed credit policy	Average collection period (days)	Expected annual sales (Amount in ₹ lakh)
I	30	65
II	40	70
III	50	74

**Required:**

Which credit policy should the company adopt?

Present your answer in a tabular form. Assume 360-day a year. Calculations should be made up to two digits after decimal. Ignore taxation.

7



- (b) Jai & Karti Ltd. sells 1000,000 bottles of Soda in a year. Each bottle produced has a variable cost of ₹5 and sells for ₹10. Fixed operating costs are ₹10,00,000. The company has debt of ₹12,00,000 at 10% rate of interest.

As a Cost and Management Accountant you are required to **calculate**:

- (i) The Degree of Operating Leverage,
- (ii) The Degree of Financial Leverage, and
- (iii) The Degree of Total Leverage.

5

9. (a) You have been provided the following particulars pertaining to the three companies A LTD., B LTD., and D LTD., operating identical business:

Company	A Ltd	B Ltd	D Ltd
EBIT (₹)	15,00,000	15,00,000	15,00,000
No. of Shares	3,00,000	2,50,000	2,00,000
12% debentures (₹)		9,00,000	10,00,000

Every company expects 12% Return on investment (ROI)

**Required:**

**Find out the value** of the Companies A LTD., B LTD., and D LTD., and value of their equity shares as per the Modigliani-Miller (MM) approach

5

- (b) ZENITH LTD. is faced with the problem of choosing between two mutually exclusive projects A and B. Project A requires a cash outlay of ₹10,00,000 and cash running expenses of ₹3,50,00 per year. On the other hand, Project B will cost ₹15,00,000 and require cash running expenses of ₹2,00,000 per year. Both the projects have been an eight-year life. Project A has a salvage value of ₹40,000 and Project B has a salvage value 1,40,000. The company's tax rate is 50% and it has a 10% required rate of return.

**Required:**

Assuming depreciation on straight line basis and that there is no funds constraint for the company, **Ascertain which project** should be accepted.

[Given: **PVIFA** (10%, 8 years) = 5.335 and **PVIF** (10%, 8 years) = 0.467]

Note: Solve the problem by an incremental cash flow approach.

7

10. Write short notes on any *three* out of the following:

4 × 3 = 12

- (i) Defensive-Interval Ratio (DIR)
- (ii) Venture Capital
- (iii) Advantages of Ratio Analysis
- (iv) Danger of inadequate of working capital



## INTERMEDIATE EXAMINATION

June 2018

P-10 (CMFM)

Syllabus 2016

### Cost & Management Accounting and Financial Management

Time Allowed: 3 Hours

Full Marks: 100

*The figures in the margin on the right side indicate full marks.*

*All workings must form part of your answer.*

*Assumptions, if any, must be clearly indicated.*

*Please (i) Write answers to all parts of a question together.*

*(ii) Open a new page for answers to a new question.*

*(iii) Attempt the required number of questions only.*

This Paper has been divided into two Parts A & B, each carrying 50 marks.

Further each Part has been divided into two sections each.

#### Part - A

#### (COST & MANAGEMENT ACCOUNTING)

(50 Marks)

#### Section - I

Answer the following questions.

1. (a) Choose the correct answer from the given four alternatives (You may write only the Roman numeral and alphabet chosen for your answer): 1×6=6
- (i) Decision-making concerns with:
- (A) Past
  - (B) Future
  - (C) Past and Future both
  - (D) None of the above
- (ii) A large Margin of Safety indicates
- (A) Over-Capitalization
  - (B) The soundness of business
  - (C) Over Production
  - (D) None of the above
- (iii) Revision of budgets is
- (A) Unnecessary
  - (B) Cannot determine
  - (C) Necessary
  - (D) Inadequate data





- (iv) Which of the following operating measures would a manager would like to see decreasing over time?
  - (A) Merchandise Inventory Turn-over
  - (B) Total quality cost
  - (C) % of on-time deliveries
  - (D) Finished Goods Inventory Turn-over
- (v) Which of the following departments is most likely responsible for a Price Variance in Direct Materials?
  - (A) Warehousing
  - (B) Receiving
  - (C) Purchasing
  - (D) Production
- (vi) Another name for the 'Learning Curve' is
  - (A) Exponential Curve
  - (B) Growth Curve
  - (C) Production Curve
  - (D) Experience Curve

(b) **Match the statement under Column I with the most appropriate statement under Column II:** (You may opt to write only the numeral and the matched the alphabet instead of copying contents into the answer books.): 1x4=4

Column I		Column II	
1	Distinctive feature of Learning curve	(A)	on the principle of exception.
2	Standard Costing works	(B)	is designed to fix responsibilities on executives, through the preparation of budgets.
3	Budgetary Control System	(C)	is that notional value at which goods and services are transferred between divisions in a decentralized organization.
4	Transfer Price	(D)	Persons engaged in repetitive task will improve his performance over time.

- (c) **State whether the following statements are True or False:** (You may write only the Roman numeral and whether True or False without Coping the Statements into the answer books.): 1x4=4
- (i) Management Accounting is largely based on estimates and as such total accuracy is not ensured under Management Accountancy.
  - (ii) The main objective of Budgetary control is to co-ordinate the different departments.
  - (iii) Standard Costing are applicable in Banking Industry.
  - (iv) Learning Curve is a Cost Reduction technique.

**Section - II**

Answer any three questions from Question No. 2, 3, 4 and 5.

Each Question carries 12 Marks.

2. (a) QUALITY PRODUCTS LTD., manufactures and markets a single product.



The following data are available:

	₹/Unit
Materials	16
Conversion Costs (Variable)	12
Dealer's Margin (10% of Sales)	4
Selling Price	40
Fixed Cost: ₹ 5 Lakhs	
Present Sales : 90,000 units	
Capacity Utilization : 60%	

There is acute competition. Extra efforts are necessary to sell. Suggestions have been made for increasing sales:

- (A) By reducing Selling Price by 5%
- (B) By increasing dealer's margin by 25% over the existing rate.

Required:

- (i) Which of these two suggestion you would recommend, if the company desires to maintain the present profit?
- (ii) Give reasons. 4+2=6

(b) XYZ Co. purchases 40,000 glass cases per annum from an outside supplier at ₹ 5 each. The production manager feels that these should be manufactured and not purchased. A machine costing ₹ 1,00,000 (no salvage value) will be required to manufacture the item within the factory. The machine has an annual capacity of 60,000 units and life of 5 years. The costs required for manufacture of each glass case is as follows:

Direct Materials            ₹ 2.00  
Direct Labour                ₹ 1.00  
Variable overheads 100% of Labour Cost

Required:

- (i) Should the company continue to purchase the glass cases from outside supplier or should it make them in the factory?
- (ii) Should the company accept an order to supply 10000 glass cases to the market at a selling price of ₹4.50 per unit? 3x2=6

3. (a) The Standard Material cost to produce a tonne of prefabricated building material of AJANTA LTD. is:

300 kgs. of material X @ ₹ 10 per kg.  
400 kgs. of material Y @ ₹ 5 per kg.  
500 kgs. of material Z @ ₹ 6 per kg.

During December 2017, 100 tonnes of mixture prefabricated building material were produced from the usage of:



35 tonnes of material X at a cost of ₹ 9,000 per tonne  
 42 tonnes of material Y at a cost of ₹ 6,000 per tonne  
 53 tonnes of material Z at a cost of ₹ 7,000 per tonne

Required:

Calculate the following variances:

- (i) Total material cost variance
- (ii) Total and individual material price variances
- (iii) Total and individual material usage variances

2x3=6

(b) The following details are available for ABC LTD. A manufacturing company:

	Budgeted Expenses, units & hrs.	Actual Expenses, units & hrs.
Variable Overheads (₹)	5,00,000	5,20,000
Output in units	50,000	40,000
Working hours	2,50,000	2,20,000

**You are Required to** Calculate the following variances:

- (i) Variable Overhead Expenditure Variance
- (ii) Variable Overhead Efficiency Variance
- (iii) Total Variable Overhead Variance

2x3=6

4. (a) PENTAX LTD., has prepared its Expense Budget for 20,000 units in its factory for a year as detailed below:

Particulars	₹/unit
Direct Material	50
Direct Labour	20
Variable Overhead	15
Direct Expenses	6
Selling Expenses (20% Fixed)	15
Factory Expenses (100% Fixed)	7
Administrative Expenses (100% Fixed)	4
Distribution Expenses (85% Variable)	12
Total (₹)	129

Required:

Prepare an Expenditure Budget for the Production of 15,000 units and 18,000 units.

6

(b) JANAK LTD. received an order to make and supply sixteen units of standard product which involves intricate labour operations. The first unit was made in 8 hours. It is understood that this type of operations is subject to 90% learning rate. The workers are getting a wage rate of ₹ 15 per hour.

Required:

What is the total time and labour cost required to execute the above order?

6



5. Write short note on any three of the following:

4×3=12

- (a) Concept of Management Accounting
- (b) Performance Budgeting
- (c) Transfer Pricing
- (d) Difference between Standard Costing and Budgetary Control. (any four)

**Part – B**

**(Financial Management)**

**(50 Marks)**

**Section - III**

Answer the following questions:

6. (a) Choose the correct answer from the given four alternatives (You may write only the Roman numeral and alphabet chosen for your answer):

1×6=6

- (i) Which of the following is a Profitability Ratio?
  - (A) Proprietary Ratio
  - (B) Debt-Equity Ratio
  - (C) Price-Earning Ratio
  - (D) Fixed Asset Ratio
- (ii) Which of the following is not a source of fund?
  - (A) Issue of Capital
  - (B) Issue of Debenture
  - (C) Decrease in Working Capital
  - (D) Increase in Working Capital
- (iii)  $\beta$  (Beta) of a security measures its
  - (A) Divisible Risk
  - (B) Financial Risk
  - (C) Market Risk
  - (D) None of the above
- (iv) The following is not a Discounted Cash Flow Technique:
  - (A) NPV
  - (B) PI
  - (C) Accounting of Average Rate of Return
  - (D) IRR
- (v) The 'Dividend-Payout Ratio' is equal to
  - (A) The Dividend yield plus the capital gains yield
  - (B) Dividends per share divided by Earning per Equity Share
  - (C) Dividends per share divided by par value per share
  - (D) Dividends per share divided by current price per share



(vi) If EBIT = ₹ 1,00,000, Fixed Assets = ₹ 2,00,000, Sales = ₹ 10,00,000 and Variable Cost = ₹ 7,00,000. Then, the Operating Leverage will be

- (A) 2
- (B) 3
- (C) 6
- (D) 4

(b) **Match the statement under Column I with the most appropriate statement under Column II:** 1x4=4

Column I		Column II	
1.	Dividend Models	(A)	Modigliani and Miller Hypothesis
2.	Theory of Capital Structure	(B)	Fund Based Financial service
3.	Factoring	(C)	Indicator of Short-term solvency of a company
4.	Liquid Ratio	(D)	Gorden Model

(c) **State whether the following statements are True or False:** (You may write only the Roman numeral and whether True or False without copying the statements into answer the books.) 1x4=4

- (i) Debt Service Coverage Ratio indicates the liquidity of a firm in relation to its ability to meet projected daily expenditure from operations.
- (ii) Bill Discounting is defined as the relationship between the seller of goods and a financial firm, called the Factor.
- (iii) Finance is called the "Chemistry of money".
- (iv) Capital Budgetary Forecasts Returns on proposed long-term investments and compares profitability of different Investments and their cost of capital.

**Section - IV**

Answer any *three* questions from Question No. 7, 8, 9 and 10.  
Each Question carries 12 Marks.

7. (a) The following is the summary of Financial Ratios and form of a TEXTILE COMPANY having a sale of ₹ 32 lakh.

Sales to net worth (times)	2.3
Current debt to net worth (%)	42
Total debt to net worth (%)	75
Current ratio (times)	2.9
Net sales to inventory (times)	4.7
Fixed assets to net worth (%)	53.2



Proforma Balance Sheet

Net worth	---	Fixed assets	---
Long-term debt	---	Cash	---
Current debt	---	Stock	---
	---	Sundry debtors	<u>568889</u>
	---		---

You are **required to Complete** the Proforma Balance Sheet.

6

(b) INDOGROWTH LTD provides the following data:

	March 31, 2018	March 31, 2017	Increase (decrease)
<i>Debit Balance</i>			
Working capital	₹ 2,00,000	₹ 1,00,000	₹ 1,00,000
Investments	1,00,000	1,50,000	(50,000)
Building & Equipment	5,00,000	4,00,000	1,00,000
Land	<u>40,000</u>	<u>50,000</u>	<u>(10,000)</u>
	<u>8,40,000</u>	<u>7,00,000</u>	<u>1,40,000</u>
<i>Credit Balance</i>			
Accumulated depreciation	1,00,000	50,000	50,000
Bonds	3,40,000	3,40,000	---
Reserves	<u>2,00,000</u>	<u>1,50,000</u>	<u>50,000</u>
Equity shares	<u>8,40,000</u>	<u>7,00,000</u>	<u>1,40,000</u>

*Income statement for the period ending March 31, 2018*

Sales		₹ 10,00,000
Cost of goods sold		<u>5,00,000</u>
		5,00,000
Selling expenses	₹ 50,000	
Administrative expenses	50,000	<u>1,00,000</u>
Operating income		4,00,000
<i>Other charges and credits:</i>		
Gain on sale of building and equipment	₹ 5,000	
Loss on sale of investments	(10,000)	
Interest	(6,000)	
Taxes	(1,89,000)	<u>(2,00,000)</u>
Net income after taxes		2,00,000

Notes:

- (i) The depreciation charged for the year ended March's, 2018 was ₹ 60,000.
- (ii) The book value of the building and equipment disposed off was ₹ 10,000.
- (iii) Land was sold at no profit no loss basis.

Required:

Prepare a Funds Flow Statement for the period ending March 31, 2018.

6



8. (a) The management of CAMELLIA LTD. has called for a statement showing the working capital needed to finance a level of activity of 3,00,000 units of output for the year ended March 31, 2018. The cost structure for the company's product, for the above mentioned activity level, is detailed below:

	Cost per unit
Raw materials	₹ 20
Direct labour	5
Overheads	<u>15</u>
Total cost	40
Profit	<u>10</u>
Selling price	50

Past trends indicate that the raw materials are held in stock, on an average, for two months. Work-in-process (50 per cent complete) will approximate to ½ month's production. Finished goods remain in warehouse, on an average, for 1 month. Suppliers of materials extend 1 month's credit. Two month's credit is normally allowed to debtors. A minimum cash balance of ₹ 25,000 is expected to be maintained. The production pattern is assumed to be even during the years. (12 months)

Required:

Prepare a statement of Working Capital determination.

7

- (b) The following information is available for AVANTI CORPORATION:

Earning per share	₹ 6
Rate of Return on Investment	20%
Rate of return required by share holders	16%

Required:

What should be the approximate dividend pay-out ratio so as to keep the share price at ₹ 44 by using Walter Model?

5

9. (a) The CMD Ltd. has the following specific cost of capital along with the indicated book and market value weights:

Type of Capital	Cost	Book value weights	Market value weights
Equity	0.18	0.50	0.58
Preference shares	0.15	0.20	0.17
Long-term debt	0.07	<u>0.30</u>	<u>0.25</u>
		<u>1.00</u>	<u>1.00</u>

Required:

- Calculate the weighted cost of capital, using book and market value weights.
- Calculate the weighted average cost of capital, using marginal weights, if the company intends to raise the needed funds using 50 per cent long-term debt, 35 per cent preference shares and 15 per cent retained earnings.

Note: Ignore Taxation

6



- (b) ANURAG MILLS LTD. has number of machines that were used to make a product that the firm has phased out of its operations. An existing machine was originally purchased six years ago for ₹ 5,00,000 and is being depreciated by the straight line method; its remaining useful life is 4 years. No salvage value is expected at the end of the useful life. It can currently be sold for ₹1,50,000. The machine can also be modified to produce another product at a cost of ₹2,00,000. The modifications would not affect the useful life, or salvage value, and would be depreciated using the straight line method.

If the firm does not modify the existing machine, it will have to buy a new machine at a cost of ₹ 4,40,000, (no salvage value) and the new machine would be depreciated over 4 years. The engineers estimate that the cash operating costs with the new machine would be ₹ 25,000 per year less than with the existing machine. Cost of capital is 15 per cent and corporate tax rate is 35 per cent.

Advise the company whether the new machine should be bought, or the old equipment modified. Assume straight line method of depreciation for tax purposes and loss on sale of existing machine can be claimed as short-term capital loss in the current year itself.

[Given: PVIFA (15% 4 years) = 2.855]

6

10. Write short note on *any three* of the following:

4×3=12

- (a) Debtors Turnover Ratio
- (b) Determinants of Working Capital
- (c) Advantages of Ratio Analysis (any four)
- (d) Differences between Fund Flow Statement and Cash Flow Statement

**The Directorate of Studies is committed to keep abreast of CMA Students with the latest amendments/notifications/advancements on each subject on regular basis. Students are requested to visit CMA Students' Portal [<https://icmai.in/studentswebsite/>] regularly to view the updates.**